

**DIAGNOSTIC AND
SURGICAL HYSTEROSCOPY**

DIAGNOSTIC AND SURGICAL HYSTEROSCOPY

1

BASIC SETS

2

TELESCOPES

3

HYSTEROSCOPE SHEATHS FOR 2.5 MM/4.0 MM TELESCOPES

4

HYSTEROSCOPE Ø 3.9 MM, 30°/HYSTEROSCOPE Ø 5 MM, 20°

5

FORCEPS/SCISSORS/SMALL MODULAR SYSTEM **HySafe**

6

ELECTRODES, BIPOLAR, MONOPOLAR

7

INSTRUMENTS FOR PORTIO AND UTERUS

8

HYSTEROSCOPIC RESECTION

9

FLEXIBLE HYSTEROSCOPE

10

FLUID CONTROL

11

HF GENERATOR

12

ACCESSORIES

BASIC SET FOR DIAGNOSTIC HYSTEROSCOPY

Product	Product no.	Quantity	Catalog/Section
without working channel			
Telescope 30° Ø 2.7 mm SL 310 mm	8974.402	1	Gynecology / hysteroscopy
Sheath for hysteroscope 10.5 Fr	8985.11	1	
alternative:			
Kompakt Hysteroskope Hysteroscope bndl	89864021	1	Gynecology / hysteroscopy
Handle for hysteroscope	8986.251		
Biopsy forceps bndl	8642.6312	1	
Grasping forceps bndl	8642.6502	1	

BASIC SET

FOR OPERATIVE HYSTEROSCOPY

PRINCESS™ E-LINE & S(A)LINE SYSTEM,

TELESCOPE 2.7 MM, 12°, 21 FR, PASSIVE, CONTINUOUS IRRIGATION

Product	Product no.	Quantity	Catalog/Section
Outer sheath for resectoscope 21 Fr	8653.021	1	Gynecology / hysteroscopy
Inner sheath for resectoscope 19 Fr	8653.018	1	
Obturator for resectoscope 19 Fr	8653.18	1	
Passive, mono/bipo working element with open handle, passive cutting	8653.224	1	
Telescope 12° Ø 2.7 mm SL 310 mm	8974.412	1	
Cutting electrode bipo 21 Fr	46531313	1	
Roller electrode bipo 21/24.5 Fr	4653.023	1	
Hook electrode mono/bipo 21/24.5 Fr	865303	1	
Protective sterilization sleeve for connection to max. 5 electrodes, reusable	33030	1	
Bipolar HF cable	8108....	1	
FLUID CONTROL 2225 Irrigation pump for HYS/URO/LAP bndl	22250011	1	
Balancing module	2225023	1	

MINI FIBER TELESCOPE 2.0 MM

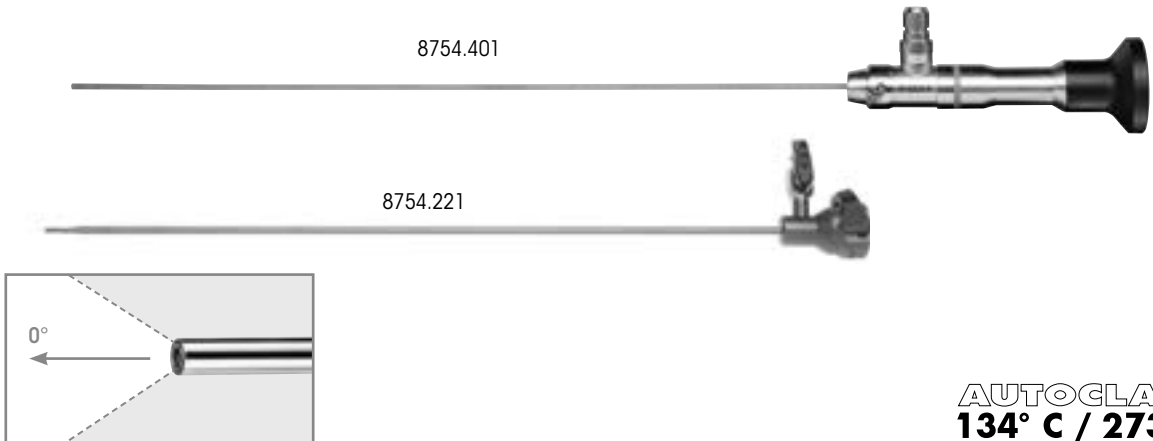

	Direction of view	WL	TL	Ø	Product no.
Telescope 0° Ø 2 mm NL 268 mm	0°	268 mm	365 mm	2.0 mm	8754401
also:					
VERES cannula Ø 2.3 mm WL 250 mm consisting of: 1x VERES cannula Ø 2.3 mm WL 274 mm (8754.211) 1x outer sheath Ø 2.8 mm, WL 250 mm (8754.221)		250 mm		2.3 mm	8754201

Recommended accessories		Product no.
Perforated basket for standard telescope 2 (for telescope 8754.401)	(L x W x H) 481 x 59 x 54 mm	38016
Fiber light cable bndl consisting of: Fiber light cable (80662523), projector-side adapter (8095.07), and endoscope-side adapter (809509)	Ø 2.5 mm, 2.3 m long	806625231

MINI SURGICAL HYSTEROSCOPE



	Direction of view	W x H	WL	TL	Product no.
Telescope 12° W 3.6 mm H 2 mm WL 227 mm with lateral eyepiece	12°	3.6 x 2.0 mm	227 mm	358 mm	8753.411

also:

	Color coding	WL	Outer Ø	Working channel	Product no.
Outer sheath for hysteroscope 15 Fr	yellow	214 mm	3.8 mm	3 Fr	8753.001
Inner sheath for hysteroscope		-	1.5 mm		8753.002
Outer sheath for hysteroscope 15 Fr	blue	214 mm	4.8 mm	5 Fr	8753.003
Inner sheath for hysteroscope		-	2.2 mm x 3.42 mm		8753.004
Outer sheath for hysteroscope 15.5 Fr	green	214 mm	5.4 mm	7 Fr	8753.006
Inner sheath for hysteroscope		-	2.8 mm x 2.98 mm		8753.007
Outer sheath for hysteroscope 17.5 Fr	white	214 mm	5.8 mm	9 Fr	8753.008
Inner sheath for hysteroscope		-	3.5 mm x 4.04 mm		8753.009

Recommended accessories	Product no.
Rigid grasping forceps Ø 3 mm WL 346 mm 	8993.235
Perforated basket for hysteroscope 1 for holding replacement sheaths, with small parts basket	Internal dimens. (W x H x D): 51 x 65 x 124 mm External dimens. (W x H x D): 467 x 75 x 132 mm 38006
Fiber light cable bndl consisting of: Fiber light cable (80662523), projector-side adapter (8095.07), and endoscope-side adapter (809509)	Ø 2.5 mm, 2.3 m long 806625231

||24|| Subject to modifications. Please note that some products may not be available in all countries. Please always take note of the information that is provided with the product. For more detailed information, please consult with your contact partner or directly with Richard Wolf GmbH.

HYSTEROSCOPE TELESCOPES

Ø 2.7 MM/Ø 4.0 MM

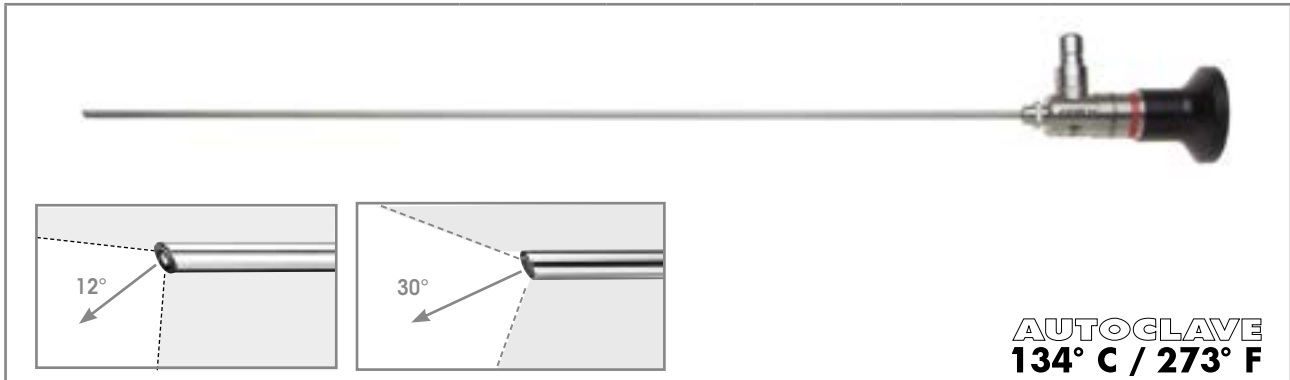

	Direction of view	Ø	SL	TL	Product no.
Telescope 12° Ø 2.7 mm SL 310 mm	12°	2.7 mm	310 mm	373 mm	8974.412
Telescope 30° Ø 2.7 mm SL 310 mm	30°	2.7 mm	310 mm	370 mm	8974.402





	Direction of view	Ø	SL	TL	Product no.
Telescope 30° Ø 4 mm SL 299 mm	30°	4.0 mm	299 mm	372 mm	8989.412

Recommended accessories		Product no.
Perforated basket for standard telescope 2	Dimensions (L x W x H): 481 x 59 x 54 mm	38016
Fiber light cable bndl consisting of: Fiber light cable (80662523), projector-side adapter (8095.07), and endoscope-side adapter (809509)	Ø 2.5 mm, 2.3 m long	806625231

||24|| Subject to modifications. Please note that some products may not be available in all countries. Please always take note of the information that is provided with the product. For more detailed information, please consult with your contact partner or directly with Richard Wolf GmbH.

DIAGNOSTIC HYSTEROSCOPE SHEATH
10.5 FR /Ø 3.5 MM
 FOR TELESCOPE 2.7 MM, 30°



						
		Sheath	WL		Product no.	
		10.5 Fr/ Ø 3.5 mm	255 mm		8985.11	
Sheath for hysteroscope 10.5 Fr round						
Handle for hysteroscope					8986.251	
also:						
		Direction of view	Ø	SL	TL	Product no.
Telescope 30° Ø 2.7 mm SL 310 mm		30°	2.7 mm	310 mm	370 mm	8974.402

Recommended accessories		Product no.
Perforated basket for standard telescope 2	Dimensions (L x W x H): 481 x 59 x 54 mm	38016
Fiber light cable bndl consisting of: Fiber light cable (80662523), projector-side adapter (8095.07), and endoscope-side adapter (809509)	Ø 2.5 mm, 2.3 m long	806625231

||24|| Subject to modifications. Please note that some products may not be available in all countries. Please always take note of the information that is provided with the product. For more detailed information, please consult with your contact partner or directly with Richard Wolf GmbH.

DIAGNOSTIC HYSTEROSCOPE SHEATH 12 FR, OVAL

FOR TELESCOPE 2.7 MM, 30°

					
	Sheath	Working channel	WL	Product no.	
	12 Fr	3 Fr	246 mm	8974.121	
Sheath for hysteroscope 12 Fr oval					
				8986.251	
Handle for hysteroscope					
also:					
	Direction of view	Ø	SL	TL	Product no.
Telescope 30° Ø 2.7 mm SL 310 mm	30°	2.7 mm	310 mm	370 mm	8974.402

Recommended accessories		Product no.
Perforated basket for standard telescope 2	Dimensions (L x W x H): 481 x 59 x 54 mm	38016
Fiber light cable bndl consisting of: Fiber light cable (80662523), projector-side adapter (8095.07), and endoscope-side adapter (809509)	Ø 2.5 mm, 2.3 m long	806625231

||24|| Subject to modifications. Please note that some products may not be available in all countries. Please always take note of the information that is provided with the product. For more detailed information, please consult with your contact partner or directly with Richard Wolf GmbH.



OptiFLOW™

HIGHFLOW CONTINUOUS IRRIGATION SURGICAL SHEATH

5.5 MM

FOR TELESCOPE 2.7 MM, 12° AND 30°



	Sheath Ø	Working channel	WL	Product no.	
 Sheath for hysteroscope 16.5 Fr distal sheath end, oval	16.5 Fr	5 Fr	219 mm	8974351	
Handle for hysteroscope				8986.251	
also:					
	Direction of view	Ø	SL	TL	Product no.
Telescope 12° Ø 2.7 mm SL 310 mm	12°	2.7 mm	310 mm	373 mm	8974.412
Telescope 30° Ø 2.7 mm SL 310 mm	30°	2.7 mm	310 mm	370 mm	8974.402



Recommended accessories	Product no.
Perforated basket for standard telescope 2	Dimensions (L x W x H): 481 x 59 x 54 mm 38016
Fiber light cable bndl consisting of: Fiber light cable (80662523), projector-side adapter (8095.07), and endoscope-side adapter (809509)	Ø 2.5 mm, 2.3 m long 806625231

||24|| Subject to modifications. Please note that some products may not be available in all countries. Please always take note of the information that is provided with the product. For more detailed information, please consult with your contact partner or directly with Richard Wolf GmbH.

DIAGNOSTIC HYSTEROSCOPE SHEATH

15 FR



FOR TELESCOPE 4 MM, 30°

					
	Sheath Ø	Working channel	WL	Product no.	
 Sheath for hysteroscope 15 Fr distal sheath end, oval	15 Fr	3 Fr	255 mm	8989.151	
Handle for hysteroscope				8986.251	
also:					
	Direction of view	Ø	SL	TL	Product no.
Telescope 30° Ø 4 mm SL 299 mm	30°	4.0 mm	299 mm	372 mm	8989.412

Recommended accessories	Product no.
Perforated basket for standard telescope 2	Dimensions (L x W x H): 481 x 59 x 54 mm 38016
Fiber light cable bndl consisting of: Fiber light cable (80662523), projector-side adapter (8095.07), and endoscope-side adapter (809509)	Ø 2.5 mm, 2.3 m long 806625231

SURGICAL CONTINUOUS IRRIGATION HYSTEROSCOPE SHEATH 15 FR OVAL

FOR TELESCOPE 4 MM, 30°







					
	Sheath	Working channel	WL	Product no.	
	15 Fr	3 Fr	230 mm	8989.031	
Sheath for hysteroscope 15 Fr distal sheath end, oval					
				8986.251	
Handle for hysteroscope					
also:					
	Direction of view	Ø	SL	TL	Product no.
Telescope 30° Ø 4 mm SL 299 mm	30°	4.0 mm	299 mm	372 mm	8989.412

Recommended accessories	Product no.
Perforated basket for standard telescope 2	Dimensions (L x W x H): 481 x 59 x 54 mm 38016
Fiber light cable bndl consisting of: Fiber light cable (80662523), projector-side adapter (8095.07), and endoscope-side adapter (809509)	Ø 2.5 mm, 2.3 m long 806625231

SURGICAL CONTINUOUS IRRIGATION HYSTEROSCOPE SHEATH

21 FR

FOR TELESCOPE 4 MM, 30°



byGallinat					
8988.031					
					
8988.231					
					
8988.241					
					
		Sheath	Working channel	WL	Product no.
	with oblique distal end, rotatable drain stopcock, and quick release lock	21 Fr	-	204 mm	8988.031
also:					
	specifically for 8988.031				8988.131
	with deflection lever and supply stopcock		7 Fr		8988.231
	with ramp and supply stopcock		7 Fr		8988.241
also:					
	Direction of view	Ø	SL	TL	Product no.
Telescope 30° Ø 4 mm SL 299 mm	30°	4.0 mm	299 mm	372 mm	8989.412
Recommended accessories					Product no.
Perforated basket for standard telescope 2		Dimensions (L x W x H): 481 x 59 x 54 mm			38016
Fiber light cable bndl consisting of: Fiber light cable (80662523), projector-side adapter (8095.07), and endoscope-side adapter (809509)		Ø 2.5 mm, 2.3 m long			806625231

||24|| Subject to modifications. Please note that some products may not be available in all countries. Please always take note of the information that is provided with the product. For more detailed information, please consult with your contact partner or directly with Richard Wolf GmbH.

HYSTEROSCOPE
3.9 MM, 30°

HYSTEROSCOPE

4



 <p>AUTOCLAVE 134° C / 273° F</p>				
	Sheath	Working channel	WL	Product no.
 <p>Hysteroscope bndl consisting of: Hysteroscope 30° Ø 3.9 mm WL 217 mm (8986402) and rubber cap capacity 0.8 mm (PACK = 10 PCS, 88.01)</p>	Ø 3.9 mm	5 Fr	217 mm	89864021
<p>Handle for hysteroscope</p>				8986.251

Recommended accessories		Product no.
<p>Perforated basket for hysteroscope 2 with small part basket</p>	<p>Internal dimensions (W x H x D): 451 x 80 x 124 mm, External dimensions (W x H x D): 467 x 90 x 132 mm</p>	38009
<p>Fiber light cable bndl consisting of: Fiber light cable (80662523), projector-side adapter (8095.07), and endoscope-side adapter (809509)</p>	Ø 2.5 mm, 2.3 m long	806625231

||24|| Subject to modifications. Please note that some products may not be available in all countries. Please always take note of the information that is provided with the product. For more detailed information, please consult with your contact partner or directly with Richard Wolf GmbH.

HYSTEROSCOPE
5 MM, 20°





	Sheath	Working channel	WL	Product no.
 Hysteroscope 20° Ø 5 mm WL 217 mm with lateral eyepiece	Ø 5 mm	5 Fr	217 mm	8986.401
Handle for hysteroscope				8986.251

Recommended accessories		Product no.
Perforated basket for hysteroscope 2 with small part basket	Internal dimensions (W x H x D): 451 x 80 x 124 mm, External dimensions (W x H x D): 467 x 90 x 132 mm	38009
Fiber light cable bndl consisting of: Fiber light cable (80662523), projector-side adapter (8095.07), and endoscope-side adapter (809509)	Ø 2.5 mm, 2.3 m long	806625231

||22|| Subject to modifications. Please note that some products may not be available in all countries. Please always take note of the information that is provided with the product. For more detailed information, please consult with your contact partner or directly with Richard Wolf GmbH.







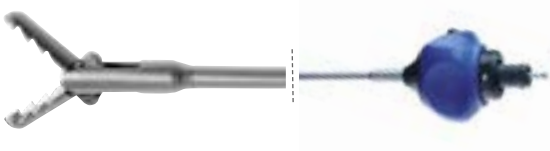

RIGID PREPARATION FORCEPS 7 FR

				
with irrigation connector	Fr	WL	TL	Product no.
 Rigid preparation forceps 7 Fr WL 371 mm with internal and external toothings	7 Fr	371 mm	460 mm	8992.621



FORCEPS AND SCISSORS

SMALL MODULAR SYSTEM **HySafe**

360° ROTATABLE, CAN BE FLUSHED THROUGH, EASY CLICK

Grasping forceps jaw insert with sheath				Handle with overload protection	Complete instrument
					<ul style="list-style-type: none"> Jaw section Handle
	Product no.	Fr	WL	8083.001	Product no.
 Grasping forceps bndI angled distally with pike-mouth jaws	8642.6508	5	340 mm	•	8642.6502
 Grasping forceps bndI with pike-mouth jaws	8992.6308	7	310 mm	•	8992.6302
 Grasping forceps bndI spoon	8642.6008	5	340 mm	•	8642.6002
 Scissors bndI	8642.6818	5	340 mm	•	8642.6812
 Biopsy forceps bndI	8642.6318	5	340 mm	•	8642.6312
 Hook scissors bndI	8992.6408	7	310 mm	•	8992.6402

MONOPOLAR ELECTRODE 5/6 FR



MONOPOLAR			
	Fr	WL	Product no.
 <p>Coagulation electrode mono 6 Fr WL 400 mm</p>	6 Fr	400 mm	823.06
 <p>Needle electrode mono 5 Fr WL 420 mm</p>	5 Fr	420 mm	824.05

HF connection cable: see page GYN42/43

1124 || Subject to modifications. Please note that some products may not be available in all countries. Please always take note of the information that is provided with the product. For more detailed information, please consult with your contact partner or directly with Richard Wolf GmbH.

FOR PORTIO AND UTERUS



	WL	TL	Product no.
 <p>Uterus grasping forceps WL 92 mm, by Pozzi with distally overlapping tips</p>	92 mm	254 mm	8370.25
 <p>Uterus grasping forceps WL 100 mm, by Gimpelson with four spherical teeth</p>	100 mm	242 mm	8371.10
 <p>Uterus grasping forceps Ø 6.5 mm WL 100 mm, by Sairges</p>	100 mm	262 mm	8370.00

for fixation, elevation, as well as hydro and chromopertubation of the uterus

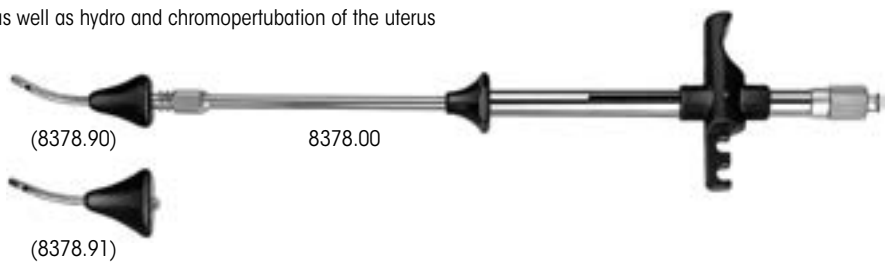

(8378.90) 8378.00







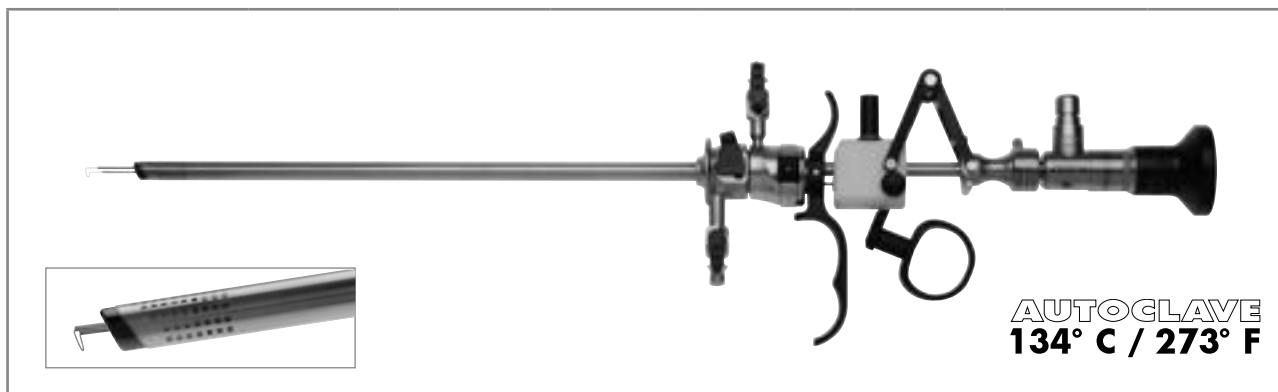

(8378.91)

	WL	TL	Product no.
<p>Intrauterine probes bndl consisting of: Intrauterine probe Ø 32 mm WL 32 mm, by Cohen (8378.00), conical portio adapter size small (8378.90), conical portio adapter size large (8378.91), tube with Luer-Lock connector (886.00)</p>	32 mm	330 mm	8378001*

*also: Uterus grasping forceps WL 92 mm, by Pozzi (8370.25)

PRINCESS
PETIT RESECTOSCOPE INCLUDING
E-LINE & S(A)LINE SYSTEM











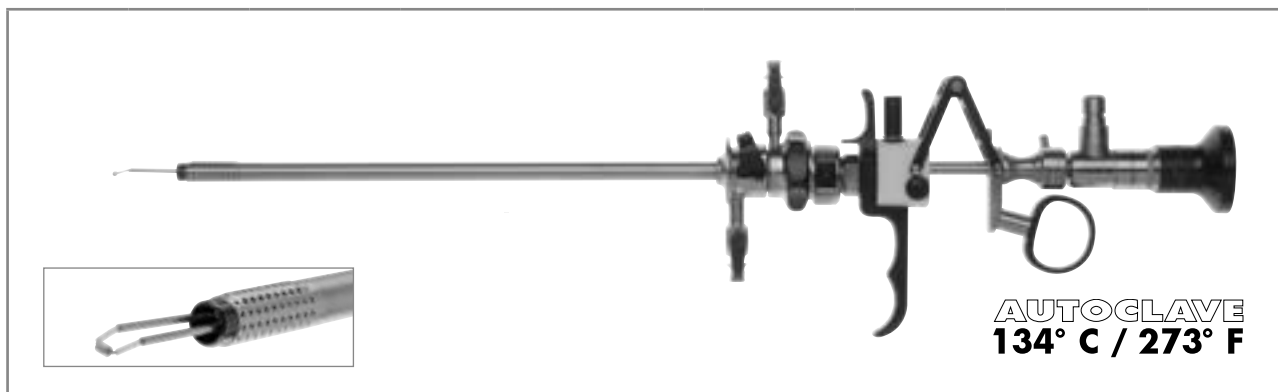



Size, Color coding	distal end	Outersheath for resectoscope 21 Fr	Inner sheath for resectoscope 19 Fr	Passive, mono/bipo working element with open handle		Telescope 12° Ø 2.7 mm SL 310 mm	Obturators	
				passive cutting	active cutting		Viewing obturator for resectoscope 19 Fr	Obturator for resectoscope 19 Fr
								
7 mm 21 Fr black		8653.021	8653.018	8653.224	8653204	8974.412	865319	8653.18
also:								
Electrodes: see page GYN22								

Recommended accessories	Product no.
Working insert for resectoscope for auxiliary instruments up to 7 Fr	 8653284
HF monopolar connection cable	see page GYN42/43
Container (W x H x D) 400 X 60 X 200 mm	Internal dimensions (W x H x D): 400 x 57 x 200 mm External dimensions (W x H x D): 466 x 77 x 266 mm 33022
Fiber light cable bndl consisting of: Fiber light cable (80662523), projector-side adapter (809.507), and endoscope-side adapter (809509)	Ø 2.5 mm, 2.3 m long 806625231

||24|| Subject to modifications. Please note that some products may not be available in all countries. Please always take note of the information that is provided with the product. For more detailed information, please consult with your contact partner or directly with Richard Wolf GmbH.

PRINCESS
PETIT RESECTOSCOPE INCLUDING
E-LINE & S(A)LINE SYSTEM, ROTATABLE



Size, Color coding	distal end	Outersheath for resectoscope	Inner sheath for resectoscope	Working element with open handle		Telescope 12° Ø 2.7 mm SL 310 mm	Obturator	
				passive cutting	active cutting		Viewing obturator for resectoscope	Obturator for resectoscope
Sheaths								
7 mm 21 Fr black		21 Fr 8653022	19 Fr 8653019	8653.224	8653204	8974.412	19 Fr 865319	19 Fr 8653.18
8 mm 24.5 Fr green		24,5 Fr 8655.334	22 Fr 8655.344				22 Fr 8654.16	
also:								
Electrodes: see page GYN22								





Recommended accessories	Product no.
Working insert for resectoscope for auxiliary instruments up to 7 Fr	 8653284
HF monopolar connection cable	see page GYN42/43
Container (W x H x D) 400 X 60 X 200 mm	Internal dimensions (W x H x D): 400 x 57 x 200 mm External dimensions (W x H x D): 466 x 77 x 266 mm 33022
Fiber light cable bndl consisting of: Fiber light cable (80662523), projector-side adapter (809.507), and endoscope-side adapter (809509)	Ø 2.5 mm, 2.3 m long 806625231

||24|| Subject to modifications. Please note that some products may not be available in all countries. Please always take note of the information that is provided with the product. For more detailed information, please consult with your contact partner or directly with Richard Wolf GmbH.

ELECTRODES

FOR PRINCESS RESECTOSCOPE,
TELESCOPE 2.7 MM, 12°

12°, for multiple use, monopolar/bipolar

	Designation	Bracket	for sheath sizes [in Fr]		Color coding		Product no.
			CI 21	CI 24.5	Fork	Stem	
	Cutting electrode mono 21 Fr	Loop round Ø 0.3 mm	•	–	red	blue	8653.131
	Cutting electrode mono 24.5 Fr	Loop round Ø 0.3 mm	–	•	blue	blue	8653.132
	Roller electrode mono 21/24.5 Fr	Roll	•	•	red	blue	8653.02
	Hook electrode mono/bipo 21/24.5 Fr	Hook	•	•	red	blue	865303

• suitable for corresponding sheath size – not suitable CI = continuous irrigation

12°, disposable, sterile* bipolar

(PACK = 3 PCS)	Designation	Bracket	for sheath sizes [in Fr]		Color coding		Product no.
			CI 21	CI 24.5	Fork	Stem	
	Cutting electrode bipo 21 Fr	Loop round Ø 0.3 mm	•	–	transparent	blue	46531313
	Cutting electrode bipo 24.5 Fr	Loop round Ø 0.3 mm	–	•	transparent	blue	4653.1323
	Roller electrode bipo 21/24.5 Fr	Roll	•	•	transparent	blue	4653.023
	BIVAP electrode bipo 21 Fr	Torus	•	–	blue	blue	46530213
	BIVAP electrode bipo 24.5 Fr	Torus	–	•	blue	blue	46530243
	Hook electrode 21/24.5 Fr	Hook	•	•	blue	blue	4653033

• suitable for corresponding sheath size – not suitable * in individual sterile packaging CI = continuous irrigation

Recommended accessories	Product no.
Protective sterilization sleeve for connection to max. 5 electrodes, reusable 	33030

1124|| Subject to modifications. Please note that some products may not be available in all countries. Please always take note of the information that is provided with the product. For more detailed information, please consult with your contact partner or directly with Richard Wolf GmbH.

RESECTION MASTER WITH AUTOMATIC CHIP SUCTION





Size, Color coding	distal end	Outersheath for resectoscope 27 Fr	Working element passive mono/bipo	Telescope 30° Ø 3.3 mm SL 299 mm	Obturator for resectoscope
			passive cutting		
					
9 mm 27 Fr black		8659.071	8659.2351	8656.422	8659.175

Recommended accessories		Product no.
Tube set RESECTION PUMP 2228 disposable	PVC, (PACK = 10 PCS) in individual sterile packaging	4170.2228
HF monopolar connection cable		see page GYN42/43
Container (W x H x D) 400 X 60 X 200 mm	Internal dimensions (W x H x D): 400 x 57 x 200 mm External dimensions (W x H x D): 466 x 77 x 266 mm	33022
Fiber light cable bndl consisting of: Fiber light cable (80662523), projector-side adapter (809.507), and endoscope-side adapter (809509)	Ø 2.5 mm, 2.3 m long	806625231

ELECTRODES

FOR RESECTION MASTER WITH AUTOMATIC CHIP SUCTION

30°, for multiple use, monopolar



	Designation	Bracket	for sheath sizes [in Fr] CI 27	Color coding		Product no.
				Fork	Stem	
	Cutting electrode mono 27 Fr	Loop round Ø 0.25 mm	•	red	red	8659.161
	Vapo electrode mono 27 Fr	Loop cylindrical	•	blue	blue	8659.162

30°, for multiple use, monopolar/bipolar

	Designation	Bracket	for sheath sizes [in Fr] CI 27	Color coding		Product no.
				Fork	Stem	
	Hook electrode mono/bipo 27 Fr	Hook	•	red	red	8659163

CI = continuous irrigation

30°, disposable, sterile*, bipolar

(PACK = 3 PCS)	Designation	Bracket	for sheath sizes [in Fr] CI 27	Color coding		Product no.
				Fork	Stem	
	Cutting electrode bipo 27 Fr	Loop round Ø 0.25 mm	•	blue	blue	4659.1613
	Roller electrode bipo 27 Fr	Loop Roll Ø 0.3 mm	•	blue	blue	4659.1623

* in individual sterile packaging **CI** = continuous irrigation

Recommended accessories

	Product no.
Protective sterilization sleeve for connection to max. 5 electrodes, reusable 	33030

RESECTION PUMP 2228

MICROPROCESSOR-CONTROLLED HIGH-PERFORMANCE CHIP SUCTION PUMP
WITH CLEAR LCD DISPLAY



		Product no.
RESECTION PUMP 2228 Suction pump		2228.001
also:		
Tube set RESECTION PUMP 2228 (PACK = 10 PCS.) packed singly, sterile	consisting of: Control tube with filter, irrigation tube with non-return valve, chip aspiration tube with non-return valve and pump tube	4170.2228
Bottle holder cpl.		64030.125
Bottle mount		64031.381
Overflow protection / bacteria filter for single use (PACK = 10 PCS)		2228.901
Chip collecting container 250 ml for tissue chips		2228.801
Tube insert for collecting container 250 ml		2228.802
Secretion container, 2 l	2 liters, without cover	8170.6551
Cover	for secretion trap 8170.6551, reusable	8170.6552
Sound absorber (PACK = 3 PCS)		35100.115
Connection tube recto pump		8170.6554
Power cable	cable length 3 m	2440.03

TECHNICAL DATA

RESECTION PUMP 2228









RESECTION PUMP 2228		2228.001
Device properties		
Operating conditions	+10°C to +40°C, 30% to 75% rel. humidity, atmospheric pressure 800 hPa to 1,060 hPa	
Storage and transport conditions	- 20°C to +60°C , 10% to 90% rel. humidity, atmospheric pressure 700 hPa to 1,060 hPa	
Power supply		
Mains + frequency	100–240 V~, 50/60 Hz	
Power consumption	120 VA	
Current rating	1.2–0.5	
Fuse	T 1.6 AL 250 V	
Regulatory standards		
Protection class to EN/IEC 60601-1 (UL 2601-1/CSA C22.2 No.601.1 – for USA)	I	
Electromagnetic compatibility (EMC)	EN/IEC 60601-1-2	
Medical Devices Directive 93/42/EEC	Class II a	
Degree of protection against the ingress of liquids	IP 20 (not protected)	
Noise level	55 dB (A) (pump "ON" with container)	
Operating mode	Continuous operation	
Protection against electric shock	Type BF applied part	
Degree of protection in the presence of flammable mixtures	Device is not protected against explosions (do not operate this device in explosive atmospheres)	
Dimensions and weights		
Weight, bndl with accessories	8.9 kg (19.6 lbs)	
Dimensions (W x H x D)	340 mm x 105 mm x 420 mm	
Space requirements with bottle holder (W x H x D)	470 mm x 410 mm x 430 mm	
Relevant application parameters		
Vacuum Operation vacuum Maximum vacuum	650 to 750 mbar +/- 50 mbar 750 mbar +/- 50 mbar	
Suction pulse Level 1 (low) Level 2 (medium) Level 3 (high)	3.8 ml +/- 0.5 ml 6.2 ml +/- 0.7 ml 9.2 ml +/- 1.0 ml	

Shark BIPOLAR RESECTOSCOPE
 FOR TELESCOPE 4 MM, 30°, 12
 WITH CONTINUOUS IRRIGATION DOUBLE SHEATH SYSTEM FOR RESECTION IN SALINE SOLUTION

Working element, inner sheath, and telescope rotate in outer sheath



AUTOCLAVE
134° C / 273° F

Size, Color coding	distal end	Outersheath for resectoscope 24 Fr	Inner sheath for resectoscope 22 Fr	Telescope 30° Ø 4 mm NL 300 mm	Telescope 12° Ø 4 mm WL 297 mm	Obturators	
						Obturator for resectoscope 22 Fr	Viewing obturator for resecto- scope 22 Fr
Sheaths							
22/24 Fr green		8675424	8675322	8654.422	8654.431	8673022	8673122

also:

Working elements: see page GYN28

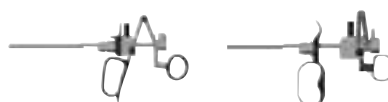





Electrodes: see page GYN29



Recommended accessories	Product no.
HF bipolar connection cable	see page GYN44/45
Perforated basket for standard telescope 2	Internal dimensions (W x H x D): 454 x 52 x 40 mm External dimensions (W x H x D): 481 x 54 x 59 mm 38016
Fiber light cable bndl consisting of: Fiber light cable (80662523), projector-side adapter (8095.07), and endoscope-side adapter (809509)	Ø 2.5 mm, 2.3 m long 806625231

WORKING ELEMENTS

FOR  BIPOLAR RESECTOSCOPES
TELESCOPE 4 MM, 30°, 12°



		Handle variants	cutting	Product no.
Active working element bipo 0/12/30° Cut is made against spring pressure		open	active	8680.204
Active working element bipo 0/12/30° Cut is made against spring pressure		closed		8680.205
Passive working element bipo 0/12/30° Cut is made with spring pressure		open	passive	8680.224
Passive working element bipo 0/12/30° Cut is made with spring pressure		closed		8680.225

Recommended accessories		Product no.
Rubber cap, black (PACK = 5 PCS)	for sealing off the electrode clamping mechanism on the working element	8880
Thumb ring with relatively large inner diameter		15008.159

1124|| Subject to modifications. Please note that some products may not be available in all countries. Please always take note of the information that is provided with the product. For more detailed information, please consult with your contact partner or directly with Richard Wolf GmbH.

ELECTRODES

FOR  BIPOLAR RESECTOSCOPES
TELESCOPE 4 MM, 30°, 12°

12°/30°, for multiple use, bipolar							
	Designation	Bracket	for sheath sizes [in Fr]		Color coding		Model
			CI	22/24	Fork	Stem	
	Cutting electrode bipo 22 Fr 12/30°	Loop round Ø 0.3 mm	•		blue	yellow	8622133
	Coag. electrode bipo 22-26 Fr 12/30°	Cylinder Ø 1.2 mm	•		blue	yellow	8623022
	Hook electrode bipo 22-26 Fr 12/30°	Hook	•		blue	yellow	862309

- suitable for corresponding sheath size **CI** = continuous irrigation

12°/30°, disposable, sterile*, bipolar							
(PACK = 3 PCS)	Designation	Bracket	for sheath sizes [in Fr]		Color coding		Model
			CI	22/24	Fork	Stem	
	Cutting electrode mono 22 Fr 12/30°	Loop round Ø 0.25 mm	•		blue	blue	4622.2533
	Cutting electrode bipo 22 Fr 12/30°	Loop round Ø 0.3 mm	•		blue	blue	4622.1333
	Coag. electrode bipo 22 Fr 12/30°	Cylinder Ø 1.2 mm	•		blue	blue	4623.0243
	BIVAP electrode bipo 22 Fr 12/30°	Torus	•		blue	blue	46300223

- suitable for corresponding sheath size * in individual sterile packaging **CI** = continuous irrigation







Recommended accessories	Product no.
Protective sterilization sleeve for connection to max. 5 electrodes, reusable 	33030

Shark MONOPOLAR RESECTOSCOPE
FOR TELESCOPE 4 MM, 30°, 12°
WITH CONTINUOUS IRRIGATION DOUBLE SHEATH SYSTEM

Working element, inner sheath, and telescope rotate in outer sheath



AUTOCLAVE
134° C / 273° F

Size, Color coding	distal end	Outersheath for resectoscope 24 Fr	Inner sheath for resectoscope 22 Fr	Telescope 30° Ø 4 mm NL 300 mm	Telescope 12° Ø 4 mm WL 297 mm	Obturator	
						Obturator for resectoscope 22 Fr	Viewing obturator for resecto- scope 22 Fr
Sheaths							
22/24 Fr green		8675424	8675322	8654.422	8654.431	8673022	8673122

also:

Working elements: see page GYN31

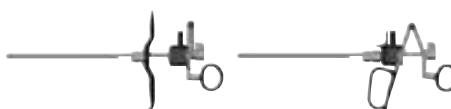

Electrodes: see page GYN32/33







Recommended accessories	Product no.
HF monopolar connection cable	see page GYN42/43
Perforated basket for standard telescope 2	Internal dimensions (W x H x D): 454 x 52 x 40 mm External dimensions (W x H x D): 481 x 54 x 59 mm 38016
Fiber light cable bndl consisting of: Fiber light cable (80662523), projector-side adapter (809.507), and endoscope-side adapter (809509)	Ø 2.5 mm, 2.3 m long 806625231

1124|| Subject to modifications. Please note that some products may not be available in all countries. Please always take note of the information that is provided with the product. For more detailed information, please consult with your contact partner or directly with Richard Wolf GmbH.

WORKING ELEMENTS

FOR  MONOPOLAR RESECTOSCOPES
TELESCOPE 4 MM, 30°, 12°

		Handle variants	cutting	Product no.
Active working element mono 12/30° Cut is made against spring pressure		closed	active	8674205
Active working element mono 12/30° Cut is made against spring pressure		closed with comfort thumb rest		8674234
Passive working element mono 12/30° Cut is made with spring pressure		open	passive	8674224
Passive working element mono 12/30° Cut is made with spring pressure		closed		8674225

Recommended accessories		Product no.
Rubber cap, red (PACK = 5 PCS)	for sealing off the electrode clamping mechanism on the working element	8874
Thumb ring with relatively large inner diameter		15008.159

ELECTRODES

FOR  MONOPOLAR RESECTOSCOPES
TELESCOPE 4 MM, 30°, 12°

12°/30°, for multiple use, monopolar

	Designation	Bracket	for sheath sizes [in Fr]		Color coding		Model
			CI	22/24	Fork	Stem	
	Cutting electrode mono 22 Fr 12/30°	Loop round Ø 0.35 mm	•		green	dark gray	86782235
	Coag. electrode mono 22–24 Fr 12/30°	Roll	•		green	dark gray	86782201
	Coag. electrode mono 22–24 Fr 12/30°	Sphere	•		green	dark gray	86782202
	Coag. electrode mono 22–24 Fr 12/30°	Button	•		green	dark gray	86782203
	Knife electrode mono 22–24 Fr 12/30°	Knife	•		green	dark gray	86782204
	Hook electrode mono 22–24 Fr 12/30°	Hook	•		green	dark gray	86782205
	Wing electrode mono 22 Fr 12/30°	Wing (bracket profile, flat)	•		green	dark gray	86782206

- suitable for corresponding sheath size **CI** = continuous irrigation

Recommended accessories

Product no.

Protective sterilization sleeve
for connection to max. 5 electrodes, reusable





33030

DISPOSABLE ELECTRODES

FOR  MONOPOLAR RESECTOSCOPES
TELESCOPE 4 MM, 30°, 12°

12°/30° disposable, sterile*, monopolar

	Designation	Bracket	for sheath sizes [in Fr]		Color coding		Model
			CI 22/24		Fork	Stem	
	Cutting electrode mono 22 Fr 12/30° (PACK = 10 PCS)	Loop round Ø 0.35 mm	•		green	transparent	46782235
	Cutting electrode mono 22 Fr 12/30° (PACK = 10 PCS)	Loop round Ø 0.25 mm	•		green	transparent	46782225
	Coag electrode mono 22–24 Fr 12/30° (PACK = 5 PCS)	Roll	•		green	transparent	46782201
	Coag electrode mono 22–24 Fr 12/30° (PACK = 5 PCS)	Sphere	•		green	transparent	46782202
	Coag electrode mono 22–24 Fr 12/30° (PACK = 5 PCS)	Button	•		green	transparent	46782203
	Knife electrode mono 22–24 Fr 12/30° (PACK = 5 PCS)	Knife	•		green	transparent	46782204
	Hook electrode mono 24 Fr 12/30° (PACK = 5 PCS)	Hook	•		green	transparent	46782205

- suitable for corresponding sheath size * in individual sterile packaging **CI** = continuous irrigation

FLEXIBLE FIBER HYSTEROSCOPE

2.5 MM/7.5 FR

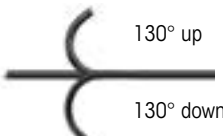



130° up
130° down

7305.782
included in scope of delivery



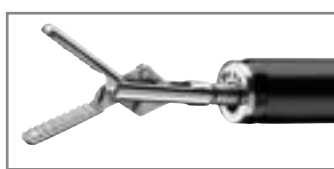



	Outer Ø	Working channel	WL	TL	Product no.
Fiber Hysteroscope Ø 2.5 mm WL 200 mm Slanted distal tip articulation +130/-130° direction of view 0°, angle of view 60°	2.5 mm 7.5 Fr	1.2 mm 3.6 Fr	200 mm	450 mm	7325.122
on request					
	Flex. grasping forceps Ø 1 mm WL 600 mm, rippled		600 mm	736 mm	7223.65

Recommended accessories	Product no.
Sterilization basket for flexible endoscopes	(W x H x D): 448 x 288 x 106 mm 33016
Fiber light cable bndl consisting of: Fiber light cable Ø 1.6 mm TL 1.8 m (80661618), projector-side adapter (809.507), and endoscope-side adapter (809509)	Ø 2.5 mm, 2.3 m long 806616181

1124|| Subject to modifications. Please note that some products may not be available in all countries. Please always take note of the information that is provided with the product. For more detailed information, please consult with your contact partner or directly with Richard Wolf GmbH.

FLUID CONTROL 2225

SUCTION IRRIGATION PUMP

core



		Product no.
FLUID CONTROL 2225 Irrigation pump for HYS/URO/LAP	Fluid management for flushing irrigation fluids into the uterus , as well as the upper and lower urinary tract, and for suction and irrigation in the abdomen	2225001
FLUID CONTROL 2225 Irrigation pump for HYS/URO/LAP bndl	consisting of: Irrigation pump for HYS/URO/LAP (2225001) Power cable (2440.03)	22250011
also:		
Balancing module	for hysteroscopy and endourology, fluid management for fluid balancing in combination with FLUID CONTROL 2225, mobile stand with integrated weighing cells and space for up to 4 irrigation fluid bags	2225023

FLUID CONTROL

10

||24|| Subject to modifications. Please note that some products may not be available in all countries. Please always take note of the information that is provided with the product. For more detailed information, please consult with your contact partner or directly with Richard Wolf GmbH.

FLUID CONTROL 2225

SUCTION IRRIGATION TUBE SETS

Irrigation			Product no.
Accessories – reusable	Tube set with piercing spike	with Luer-Lock connection, autoclavable, incl. 10 spare membranes, reusable for 20 reprocessing cycles	8171223
Accessories – disposable	Irrigation tube set with piercing spike, L 3 m	(PACK= 10 PCS), with Luer-Lock connection, sterile, disposable product	4171223
	Tube set with CARE-LOCK, L 3 m	(PACK= 10 PCS), sterile, disposable product	4171224
	Suction irrigation tube set	(PACK= 10 PCS), with piercing spike, sterile disposable product, PVC	4171225
Suction			Product no.
Accessories – reusable	Tube set for vacuum, incl. filter	with integrated hygiene filter, PACK= 10 PCS, service life: 30 days (connected to irrigation pump)	2206207
	Irrigation tube	L 1.2 m, with Luer-Lock, for suction irrigation handle 8385.901 and tube set 8171223 or 8170.223	817123
	Suction tube L 3 m	for suction irrigation handle 8385.901	8171402
	Secretion container, 2 l	2 liters, without cover	8170.6551
	Cover	for secretion trap 8170.6551, reusable	8170.6552
Accessories – disposable	Secretion container, 2.5 l	2.5 liters	41706566
	Secretion container bndl consisting of:	Secretion container 2.5 l (41706566) and secretion bag (PACK= 90 PCS) (41706564)	4170657
	Tube set for suction (2 connections)	sterile, disposable product, (PACK= 10 PCS) for connecting instruments to collecting container	T0503-01
	Straight plug-in coupling	(PACK= 10 PCS) For connecting vacuum tube 2206207 to disposable container systems	077.1018
	Angled 90° plug-in coupling	(PACK= 10 PCS) For connecting vacuum tube 2206207 to disposable container systems	077.1019

FLUID CONTROL 2225

CABLE ACCESSORIES

		Product no.
Patch cable, RJ45 SFTP, 0.5 m	Cable length 0.5 m	72325378
Patch cable, RJ45 HRS TM11, 1.0 m	Cable length 1.0 m	72325429
Patch cable, RJ45 S/FTP CAT.6 10 m	Cable length 10 m	72325434
Plastic caps for network socket	(PACK = 8 PCS)	5592105
Power cable	Cable length 3 m	2440.03

TECHNICAL DATA

FLUID CONTROL 2225

FLUID CONTROL 2225		2225001
Device properties		
Operating conditions	+10°C to +40°C, 30% to 75% rel. humidity, 70 to 106 kPa atmospheric pressure 3,000 m max. altitude above sea level	
Storage and transport conditions	-20°C to +60°C, 10% to 90% rel. humidity 70 to 106 kPa atmospheric pressure	
Power supply		
Mains + frequency	100–240 V~, 50/60 Hz	
Power consumption	100 V/60 Hz	110 VA
	240 V/50 Hz	120 VA
Current rating	100 V/60 Hz	1.10 A
	240 V/50 Hz	0.50 A
Fuse	T 3.15 AH, 250 V	
Regulatory standards		
Protection class (I, II)	I	
Electromagnetic compatibility (EMC)	EN 60601-1/IEC 60601-1 EN 60601-1-2/IEC 60601-1-2	
Medical Devices Directive 93/42/EEC	Class IIb	
Housing protection rating (IP code)	IP21	
Protection against electric shock	Type BF applied part	
Degree of protection in the presence of flammable mixtures	Device is not protected against explosions (do not operate this device in explosive atmospheres)	
Maximum suction vacuum	-60 kPa	
Dimensions and weights		
Weight	8.8 kg	
Dimensions (W x H x D)	300 mm x 157 mm x 436 mm	

Relevant application parameters	
Nominal flow range	Hysteroscopy: 800 ml/min (max. flow, not adjustable) Endourology: 10–800 ml/min (max. flow) Laparoscopy: 0.1–1.8 l/min (max. flow)
Suction power	max. 2 l/min
Starting nominal pressure range	Hysteroscopy: 15–200 mmHg Endourology: 15–90 mmHg/20–120 cmH2O Laparoscopy: 300 mmHg (not adjustable)
Pressure	0–300 mmHg
Deficit	-9,990 to +9,990 ml/0 to 99.9 l

TECHNICAL DATA

FLUID CONTROL 2225

Balancing module		2225023
Device properties		
Operating conditions	+10°C to +40°C, 30% to 75% rel. humidity, 70 to 106 kPa atmospheric pressure 3,000 m max. altitude above sea level	
Storage and transport conditions	- 20°C to + 60°C, 10% to 90% rel. humidity 70 to 106 kPa atmospheric pressure	
Regulatory standards		
Electromagnetic compatibility (EMC)	EN 60601-1/IEC 60601-1 EN 60601-1-2/IEC 60601-1-2	
Housing protection rating (IP code)	IP21	
Maximum load of container scale	16 kg/4 containers of 3 l each	
Maximum load of bag scale	23 kg/4 bags of 5 l each	
Dimensions and weights		
Weight	15.4 kg	
Dimensions (W x H x D)	618 mm x 1,064 mm x 618 mm	

HF GENERATOR 2260

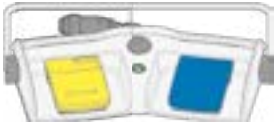

		Product no.
HF surgical generator 400 kHz	for the connection of monopolar and bipolar accessories, international version (BOWA, KLS Martin, Olympus, Karl Storz, Valleylab)	2260001
HF surgical generator 400 kHz	for the connection of monopolar and bipolar accessories, E version (Erbe)	2260002

Accessories required	Cable length	Product no.
Footswitch, 2 pedals L 5 m with fixed connection cable, reusable 		2260021
Neutral electrode for use with high-frequency surgical device, Foil bag with 5 neutral electrodes, (PACK= 50 PCS)		1280H
Mono HF neutral electrode cable, L 4.5 m	4.5 m	2260031
Power cable	3.0 m	2440.03
Bipo HF connection cable L 3 m	3.0 m	8108233
Bipo HF connection cable L 5 m	5.0 m	8108253



1124|| Subject to modifications. Please note that some products may not be available in all countries. Please always take note of the information that is provided with the product. For more detailed information, please consult with your contact partner or directly with Richard Wolf GmbH.

HF GENERATOR 2260

TECHNICAL DATA

HF surgical generator 400kHz		2260001/2260002
Device properties		
Type of controls on housing front		Touch panel
Output power	max.cutting power	400 W
	max.coagulation power	350 W
LF and HF leakage currents		acc. to DIN EN 60601 1 and DIN EN 60601 2 2
Signal level		HF indicator 55 dB(A); adjustable 45–60 dB(A) Alarm 65 dB(A)
Operating conditions		+10°C to +40°C, 30% to 75% rel humidity, 700 hPa to 1,060 hPa atmospheric pressure
Storage and transport conditions		- 20°C to + 60°C, 10% to 90% rel humidity, 700 hPa to 1,060 hPa atmospheric pressure
Power supply		
Mains + frequency		100–240 V~, 50/60 Hz
Power consumption	without HF output	45 VA
	at max. output power	650 VA
Current rating		max. 6.3 A
Fuse		T 6.3 AH 250 V
Regulatory standards		
Protection class to EN/IEC 60601-1 (UL 2601-1/CSA C222 No6011 – for USA)		I
Electromagnetic compatibility (EMC)		EN/IEC 60601-1-2
Medical Devices Directive 93/42/EEC		Class IIb
Degree of protection against the ingress of liquids (DIN EN/IEC 60529)		IPX0
Degree of protection against the ingress of solids		IP2X
Duty factor (duty cycle DC)		Intermittent INT 10 s/30 s corresponding to 25% DC
Protection against electric shock		Model CF applied part, defibrillator-proof
Degree of protection in the presence of flammable mixtures		Device is not protected against explosions (do not operate this device in explosive atmospheres)
Dimensions and weights		
Weight		10.2 kg (22.4 lbs)
Dimensions (W x H x D)		300 x 159 x 419 mm

HF CONNECTION CABLE MONO 815xxx

Instrument connector	Device connector		Product no.
<p>WOLF Resectoscopes</p> 		<p>HF connection cable mono L 3 m</p>	<p>815.032</p>
	<p>ERBE (ACC/ICC/IO)/BOWA (EU) R. Wolf HF surgical generator 400 kHz 2260002</p>	<p>HF connection cable mono L 5 m</p>	<p>815.052</p>
		<p>HF connection cable mono L 3 m</p>	<p>815.132</p>
	<p>ERBE (T series)</p>	<p>HF connection cable mono L 5 m</p>	<p>815.152</p>
<p>HF electrodes, monopolar</p> 		<p>HF connection cable mono L 3 m</p>	<p>815.031</p>
	<p>Martin (M-version)/Berchtold/ Aesculap</p>	<p>HF connection cable mono L 5 m</p>	<p>815.051</p>
		<p>HF connection cable mono L 3 m</p>	<p>815.033</p>
<p>Bovie/Valleylab/Erbe (Int.)/ BOWA (Int.) R. Wolf HF surgical generator 400 kHz 2260001</p>	<p>HF connection cable mono L 5 m</p>	<p>815.053</p>	
	<p>HF connection cable mono L 3 m</p>	<p>815.034</p>	
<p>BOWA (Int./EU) Eschmann and other devices with 4 mm plugs R. Wolf HF surgical generator 400 kHz 2260001</p>	<p>HF connection cable mono L 5 m</p>	<p>815.054</p>	

1124|| Subject to modifications. Please note that some products may not be available in all countries. Please always take note of the information that is provided with the product. For more detailed information, please consult with your contact partner or directly with Richard Wolf GmbH.

HF CONNECTION CABLE MONO 8106XXX









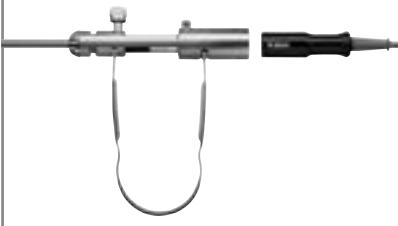

Instrument connector	Device connector		Product no.
<p>WOLF Instruments/surgical generator</p> 		<p>HF connection cable mono L 3 m</p>	<p>8106.032</p>
	<p>ERBE (ACC/ICC/IO)/BOWA (EU) R. Wolf HF surgical generator 400 kHz 2260002</p>	<p>HF connection cable mono L 5 m</p>	<p>8106.052</p>
		<p>HF connection cable mono L 3 m</p>	<p>8106.132</p>
	<p>ERBE (T series)</p>	<p>HF connection cable mono L 5 m</p>	<p>8106.152</p>
<p>HF electrodes, monopolar</p> 		<p>HF connection cable mono L 3 m</p>	<p>8106.031</p>
	<p>Martin (M-version)/Berchtold/ Aesculap</p>	<p>HF connection cable mono L 5 m</p>	<p>8106.051</p>
		<p>HF connection cable mono L 3 m</p>	<p>8106.033</p>
	<p>Bovie/Valleylab/Erbe (Int.)/ BOWA (Int.) R. Wolf HF surgical generator 400 kHz 2260001</p>	<p>HF connection cable mono L 5 m</p>	<p>8106.053</p>
		<p>HF connection cable mono L 3 m</p>	<p>8106.034</p>
	<p>BOWA (Int./EU) Eschmann and other devices with 4 mm plugs R. Wolf HF surgical generator 400 kHz 2260001/2260002</p>	<p>HF connection cable mono L 5 m</p>	<p>8106.054</p>

BIPO HF CONNECTION CABLE

8108xxx





ACCESSORIES

12

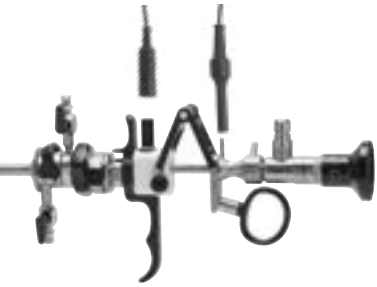

Instrument connector	Device connector		Product no.	
WOLF Bipolar forceps 	 ERBE (ACC/ICC/T)/BOWA (EU) R. Wolf HF surgical generator 400 kHz 2260001/2260002	HF connection cable bipo; L 3 m	8108.032	
		HF connection cable bipo; L 5 m	8108.052	
	 International / 2-pin Valleylab R. Wolf HF surgical generator 400 kHz 2260001/2260002	HF connection cable bipo; L 3 m	8108.033	
		HF connection cable bipo; L 5 m	8108.053	
	 WOLF/Martin (M-version)/ Berchtold/Aesculap	HF connection cable bipo; L 3 m	8108.031	
		HF connection cable bipo; L 5 m	8108.051	
	 EMC Dolley	HF connection cable bipo; L 3 m	8108035	
	Bipolar tweezers connection 	 ERBE (ACC/ICC/T)/BOWA (EU) R. Wolf HF surgical generator 400 kHz 2260001/2260002	HF connection cable bipo; L 3 m	8108.132
			HF connection cable bipo; L 5 m	8108.152
		 International / 2-pin Valleylab R. Wolf HF surgical generator 400 kHz 2260001/2260002	HF connection cable bipo; L 3 m	8108.133
HF connection cable bipo; L 5 m			8108.153	
 Martin (M-version)/Berchtold/ Aesculap		HF connection cable bipo; L 3 m	8108.131	
		HF connection cable bipo; L 5 m	8108.151	
 EMC Dolley		HF connection cable bipo; L 3 m	8108135	

1124|| Subject to modifications. Please note that some products may not be available in all countries. Please always take note of the information that is provided with the product. For more detailed information, please consult with your contact partner or directly with Richard Wolf GmbH.

HF CONNECTION CABLE BIPO FOR RESECTION IN SALINE SOLUTION

Instrument connector	Device connector		Product no.
<p>WOLF Bipolar resectoscopes</p> 	 Erbe VIO 300D	<p>Bipolar cable; TUR/TCR; WOLF MF plug; L 4 m</p>	<p>20196-119</p>
	 Erbe VIO 3	<p>BIPOLAR CABLE; MF-U MF plug; L 4.5 m</p>	<p>21196-119</p>
	 KLS Martin	<p>HF connection cable bipo; L 3 m</p>	<p>8108.231</p>
		<p>HF connection cable bipo; L 5 m</p>	<p>8108.251</p>
	 R. Wolf HF surgical generator 400 kHz 2260001/2260002		
		<p>HF connection cable bipo; L 5 m</p>	<p>8108233</p>

MONO HF NEUTRAL ELECTRODE CABLE

Instrument connector	Device connector		Product no.
<p>2-pole neutral electrode</p> 	 <p>R. Wolf HF surgical generator 400 kHz 2260001/2260002</p>	<p>Mono HF neutral electrode cable, L 4.5 m</p>	<p>2260031</p>

1124 | Subject to modifications. Please note that some products may not be available in all countries. Please always take note of the information that is provided with the product. For more detailed information, please consult with your contact partner or directly with Richard Wolf GmbH.

