

GENERAL SURGERY

GENERAL SURGERY

1

LAPAROSCOPY

2

TRANSANAL ENDOSCOPIC MICROSURGERY

3

PROCTO-REKTOSCOPY

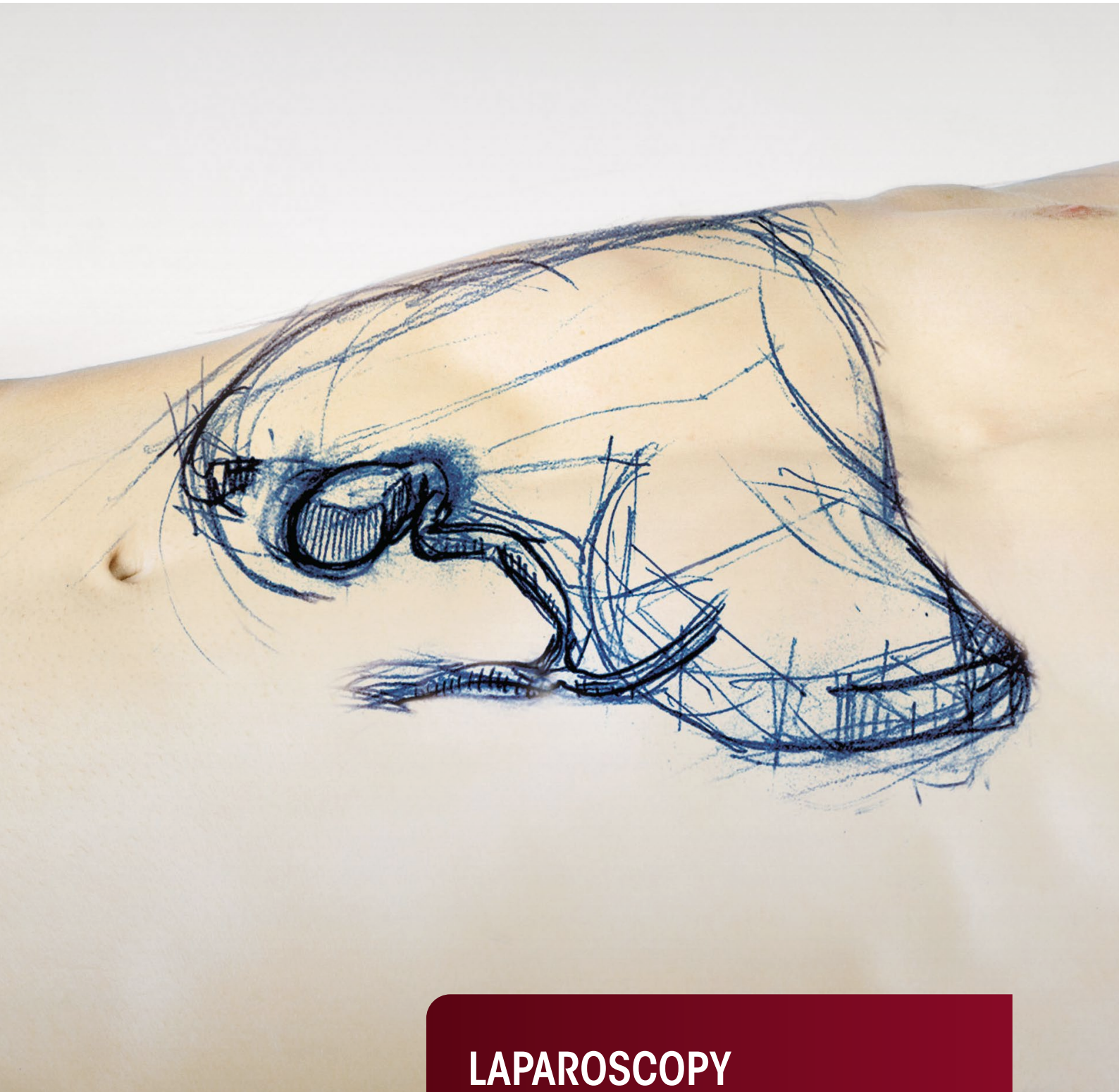

LAPAROSCOPY

LAPAROSCOPY

1

BASIC SETS

2

TELESCOPES

3

TROCAR SLEEVES / DILATION / EXTRACTION / REDUCING SLEEVES

4

ERAGONMODULAR GRASPING FORCEPS / DISSECTORS / BIOPSY FORCEPS / SCISSORS

5

GRASPING FORCEPS

6

BIPOLAR FORCEPS AND SCISSORS

7

HF ELECTRODES (MONOPOLAR/BIPOLAR)

8

MULTIFUNCTIONAL SUCTION IRRIGATION SYSTEM

9

TISSUE RETRACTOR

10

CLIP APPLICATOR

11

NEEDLE HOLDER / KNOT PUSHER / FASCIA CLOSURE

12

CANNULAS / SURGICAL PROBES / MYOMA DRILLS

13

DEVICES / ACCESSORIES

14

CHOLEDOCHOSCOPY

15

TRAINING MODELS

BASIC SET

FOR ALL LAPAROSCOPIC PROCEDURES

Product	Product no.	Quantity	Catalog / Section
Insufflator 45 EVAC + HEAT bndl	22350311	1	Laparoscopy / 14
VERES cannula Ø 2.1 mm WL 152 mm	8302.12	1	Laparoscopy / 3
LAP suction irrigation pump bndl	22160011	1	Laparoscopy / 14
LED light source ENDOLIGHT LED 2.1 bndl	51630011	1	Imaging / Light sources
Fiber light cable		1	Imaging / Light cables
ENDOCAM Logic HD	5525	1	Imaging / ENDOCAM
Monitors		1	Imaging / Monitors
Device cart		1	Imaging / Device cart

BASIC SET

FOR LAPAROSCOPIC CHOLECYSTECTOMY

Product	Product no.	Quantity	Catalog / Section
Telescope 30° Ø 10 mm WL 307 mm	8934.432	1	Laparoscopy / 2
and/or			
Telescope 0° Ø 10 mm WL 307 mm	8934.431	1	Laparoscopy / 2
Fiber light cable bndl	806650231	1	Laparoscopy / 2
Trocar sleeve, slanted, capacity 5.5 mm WL 100 mm	8921.013	2-3	Laparoscopy / 3
and/or			
Trocar sleeve, straight, capacity 5.5 mm WL 102 mm	8919.351	2-3	Laparoscopy / 3
Trocar sleeve, slanted, capacity 10 mm WL 100 mm	8923.013	2	Laparoscopy / 3
Guide rod 5.5 mm TL 500 mm	8923.921	1	Laparoscopy / 3
Instrument sleeve 10 mm WL 170 mm	8385.50	1	Laparoscopy / 3
VERES cannula Ø 2.1 mm WL 152 mm	8302.12	1	Laparoscopy / 3
Multifunctional suction irrigation system			
Suction irrigation tube Ø 5 mm WL 310 mm	8383.911	1	Laparoscopy / 8
Suction irrigation handle	8385.901	1	Laparoscopy / 8
Sealing cap	8385.902	1	Laparoscopy / 8
ERAGONmodular			
Atraumatic grasping forceps Ø 5 mm bndl	83932925	1	Laparoscopy / 4
Atraumatic grasping forceps mono Ø 5 mm bndl	83931817	2	Laparoscopy / 4
Maryland dissector forceps mono Ø 5 mm bndl	83932817	1	Laparoscopy / 4
Metzenbaum scissors Ø 5 mm bndl	83930417	1	Laparoscopy / 4
Grasping forceps Ø 10 mm bndl	83952048	1	Laparoscopy / 4
Plate-shaped grasping forceps Ø 10 mm bndl	83952347	1	Laparoscopy / 4
Hook electrode mono Ø 5 mm WL 340 mm			
Clip applicator Ø 10 mm WL 340 mm	8389.911	1	Laparoscopy / 10
Ethicon® Ligaclips® (PACK= 108 PCS)	8389.915	1	Laparoscopy / 10
Needle forceps Ø 2.45 mm WL 160 mm	8756.201	1	Laparoscopy / 11
Sealing cone Ø 12-15 mm	8943.915	1	Laparoscopy / 11
Monopolar HF cable	8106	2	Laparoscopy / 14

BASIC SET FOR LAPAROSCOPIC CHOLECYSTECTOMY

Product	Product no.	Quantity	Catalog / Section
Also on request:			
Telescope 30° Ø 5.3 mm WL 303 mm	8935442	1	Laparoscopy / 2
Trocar sleeve, slanted, capacity 5.5 mm WL 100 mm	8921.013	1	Laparoscopy / 3
Trocar tip sharp size 5.5 mm WL 169 mm	8921.113	1	Laparoscopy / 3
ERAGONmodular			
Atraumatic grasping forceps mono Ø 5 mm bndl	83931957	1	Laparoscopy / 4
Biopsy forceps mono Ø 5 mm bndl	83930937	1	Laparoscopy / 4
Dissector forceps Ø 10 mm bndl	83952268	1	Laparoscopy / 4
ERAGONbipolar			
Grasping forceps bipo Ø 5.5 mm bndl	839300312	1	Laparoscopy / 6

In addition to laparoscopic choledochus revision			
Grasping forceps Ø 5 mm WL 295 mm	8383311	1	Laparoscopy / 5

BASIC SET

FOR LAPAROSCOPIC APPENDECTOMY

Product	Product no.	Quantity	Catalog / Section
Telescope 30° Ø 10 mm WL 307 mm	8934.432	1	Laparoscopy / 2
and/or			
Telescope 0° Ø 10 mm WL 307 mm	8934.431	1	Laparoscopy / 2
Fiber light cable bndl	806650231	1	Laparoscopy / 2
Trocar sleeve, slanted, capacity 10 mm WL 100 mm	8923.013	2	Laparoscopy / 3
Trocar tip sharp size 10 mm	8923.113	2	Laparoscopy / 3
and/or			
Trocar sleeve, straight, capacity 5.5 mm WL 102 mm	8919.351	2-3	Laparoscopy / 3
Trocar tip sharp size 5.5 mm WL 144 mm	8919.3512	2-3	Laparoscopy / 3
Trocar sleeve, slanted, capacity 5.5 mm WL 100 mm	8921.013	2-3	Laparoscopy / 3
Trocar tip sharp size 5.5 mm WL 169 mm	8921.113	2-3	Laparoscopy / 3
Guide rod 5.5 mm TL 500 mm	8923.921	1	Laparoscopy / 3
Instrument sleeve 10 mm WL 170 mm	8385.50	1	Laparoscopy / 3
ERAGONmodular			
Grasping forceps mono Ø 5 mm bndl	83932877	1	Laparoscopy / 4
Atraumatic grasping forceps mono Ø 5 mm bndl	83931817	2	Laparoscopy / 4
Maryland dissector forceps mono Ø 5 mm bndl	83932817	1	Laparoscopy / 4
Metzenbaum scissors Ø 5 mm bndl	83930417	1	Laparoscopy / 4
Grasping and dissector forceps 5 mm	83932827	1	Laparoscopy / 4
ERAGONbipolar			
Grasping forceps bipo Ø 5.5 mm bndl	839300312	1	Laparoscopy / 6
Multifunctional suction irrigation system			
Suction irrigation tube Ø 5 mm WL 310 mm	83839.11	1	Laparoscopy / 8
Suction irrigation handle	8385.901	1	Laparoscopy / 8
Sealing cap	8385.902	1	Laparoscopy / 8
Surgical probe Ø 5 mm WL 328 mm			
Surgical probe Ø 5 mm WL 328 mm	8383.66	1	Laparoscopy / 12
VERES cannula Ø 2.1 mm WL 152 mm	8302.12	1	Laparoscopy / 3
Bipolar HF cable	8108	1	Laparoscopy / 14
Monopolar HF cable	8106	1	Laparoscopy / 14

BASIC SET

FOR LAPAROSCOPIC APPENDECTOMY

Product	Product no.	Quantity	Catalog / Section
Also on request:			
ERAGONmodular			
Dissector forceps mono Ø 5 mm bndl	83932897	1	Laparoscopy / 4
Grasping forceps mono Ø 5 mm bndl	83931837	2	Laparoscopy / 4
Biopsy forceps mono Ø 5 mm bndl	83930917	1	Laparoscopy / 4
Maryland dissector forceps Ø 10 mm bndl	83952257	1	Laparoscopy / 4
Clip applicator Ø 10 mm WL 340 mm	8389.911	1	Laparoscopy / 10
Ethicon® Ligaclips® (PACK= 108 PCS)	8389.915	1	Laparoscopy / 10
Introduction sleeve 10 mm WL 80 mm	8389.991	1	Laparoscopy / 10
Needle holder Ø 5 mm bndl	8393.502	1	Laparoscopy / 11

BASIC SET LEVD

LAPAROSCOPIC SINGLE-CHANNEL VARICOCELE DISSECTION

Product	Product no.	Quantity	Catalog / Section
OR endoscope bndl	8920.4011	1	Laparoscopy / 2
Perforated basket for telescope	38008		Laparoscopy / 2
Fiber light cable bndl	806625231	1	Laparoscopy / 2
Trocar sleeve, straight, capacity 5.5 mm WL 102 mm	8919.353	1	Laparoscopy / 3
Optional:			
Trocar tip blunt size 5.5 mm WL 144 mm	8919.3511	1	Laparoscopy / 3
Trocar tip sharp size 5.5 mm WL 144 mm	8919.3512	1	Laparoscopy / 3
Trocar tip triangular size 5.5 mm WL 144 mm	8919.3513	1	Laparoscopy / 3
ERAGONmodular mini			
Universal grasping forceps Ø 3.5 mm bndl	83912097	1	Laparoscopy / 4
Atraumatic grasping forceps Ø 3.5 mm bndl	83912087	1	Laparoscopy / 4
Babcock forceps Ø 3.5 mm bndl	83912107	1	Laparoscopy / 4
Dissector forceps mono Ø 3.5 mm bndl	83912077	1	Laparoscopy / 4
Hook scissors mono Ø 3.5 mm bndl	83912277	1	Laparoscopy / 4
Metzenbaum scissors mono Ø 3.5 mm bndl	83912247	1	Laparoscopy / 4
Connection cable			
Bipolar HF cable	8108	1	Laparoscopy / 14
Monopolar HF cable	8106	1	Laparoscopy / 14

BASIC SET

MINI E-MILOS

Product	Product no.	Quantity	Catalog / Section
Telescope 30° Ø 10 mm WL 307 mm	8934.432	1	Laparoscopy / 2
Light tube for MILOS method Ø 10 mm	893420	1	Laparoscopy / 2
Trocar sleeve, straight, capacity 3.5 mm WL 100 mm	8903.014	2	Laparoscopy / 3
Trocar tip blunt size 3.5 mm WL 169 mm	8903.103	2	Laparoscopy / 3
ERAGONmodular mini			
Handle, pistol-shaped, mono	83930073	4	Laparoscopy / 4
Sheath tube insulated Ø 3.5 mm SL 330 mm	8391933	4	Laparoscopy / 4
Dissector forceps insert Ø 3.5 mm	8391222	1	Laparoscopy / 4
Metzenbaum scissors insert Ø 3.5 mm	8391215	1	Laparoscopy / 4
Grasping forceps insert Ø 3.5 mm	8391208	2	Laparoscopy / 4
Electrode			
Hook electrode mono Ø 3.5 mm WL 310 mm	8379.452	1	Laparoscopy / 7
ERAGONstitch			
Needle holder insert Ø 3.5 mm	8391506	1	Laparoscopy / 11
Sheath tube Ø 3.5 mm SL 330 mm	8391533	1	Laparoscopy / 11
Needle holder handle, axial	8393943	1	Laparoscopy / 11

BASIC SET

E-MILOS

Product	Product no.	Quantity	Catalog / Section
Telescope 30° Ø 10 mm WL 307 mm	8934.432	1	Laparoscopy / 2
Light tube for MILOS method Ø 10 mm	893420	1	Laparoscopy / 2
Trocar sleeve, straight, capacity 5.5 mm WL 100 mm	8921.014	2	Laparoscopy / 3
Trocar tip blunt size 5.5 mm WL 169 mm	8921.103	2	Laparoscopy / 3
ERAGONmodular			
Handle, pistol-shaped, mono	83930073	4	Laparoscopy / 4
Sheath tube insulated Ø 5 mm SL 330 mm	8391933	4	Laparoscopy / 4
Dissector forceps insert Ø 5 mm	8393240	1	Laparoscopy / 4
Metzenbaum scissors insert Ø 5 mm	8393.041	1	Laparoscopy / 4
Grasping forceps insert Ø 5 mm	8393.181	2	Laparoscopy / 4
Electrode			
Hook electrode mono Ø 5 mm WL 340 mm	8383.423	1	Laparoscopy / 7
ERAGONstitch			
Needle holder insert Ø 5 mm	8393508	1	Laparoscopy / 11
Sheath tube Ø 5 mm SL 330 mm	8393533	1	Laparoscopy / 11
Needle holder handle, axial	8393943	1	Laparoscopy / 11

BASIC SET

LAPAROSCOPIC BARIATRIC SURGERY

Product	Product no.	Quantity	Catalog / Section
Telescope 0° Ø 10 mm WL 305 mm	8934461	1	Laparoscopy / 2
Telescope 30° Ø 10 mm WL 305 mm	8934462	1	Laparoscopy / 2
Fiber light cable bndl	806550231	1	Laparoscopy / 2
Trocar sleeve, straight, capacity 5.5 mm WL 150 mm	8921.016	3	Laparoscopy / 3
Trocar sleeve, straight, capacity 10 mm WL 150 mm	8923.016	1	Laparoscopy / 3
Trocar sleeve, straight, capacity 12.5 mm WL 150 mm	8924.016	1	Laparoscopy / 3
Optional:			
Trocar tip sharp size 5.5 mm	8921.115	3	Laparoscopy / 3
Trocar tip sharp size 10 mm	8923.115	1	Laparoscopy / 3
Trocar tip sharp size 12.7 mm	8924.115	1	Laparoscopy / 3
Reducing adapter	8923.802	1	Laparoscopy / 3
Multifunctional suction irrigation system			
Suction irrigation tube Ø 5 mm WL 450 mm	8384.911	1	Laparoscopy / 8
Suction irrigation handle	8385.901	1	Laparoscopy / 8
Sealing cap	8385.902	1	Laparoscopy / 8
Suction irrigation tube set with piercing spike L 3 m	4170.956	1	Laparoscopy / 8
ERAGONmodular			
Atraumatic grasping forceps mono Ø 5 mm bndl	83941817	1	Laparoscopy / 4
Dissector forceps mono Ø 5 mm bndl	83942407	1	Laparoscopy / 4
Metzenbaum scissors mono Ø 5 mm bndl	83940417	1	Laparoscopy / 4
Atraumatic Grasping forceps Ø 5 mm bndl	83942297	1	Laparoscopy / 4
Biopsy forceps mono Ø 5 mm bndl	83940917	1	Laparoscopy / 4
Atraumatic Grasping forceps Ø 5 mm bndl	83942507	1	Laparoscopy / 4
Stapler head grasping forceps Ø 10 mm bndl	83976558	1	Laparoscopy / 4
Plate-shaped grasping forceps Ø 10 mm bndl	83962347	1	Laparoscopy / 4
Babcock forceps Ø 10 mm bndl	83961877	1	Laparoscopy / 4
ERAGONbipolar			
Maryland dissector bipo Ø 5.5 mm bndl	839400322	1	Laparoscopy / 6
Metzenbaum scissors bipo Ø 5.5 mm bndl	839400412	1	Laparoscopy / 6
Electrode			
Hook electrode mono Ø 5 mm WL 420 mm	8384.423	1	Laparoscopy / 7

BASIC SET

LAPAROSCOPIC BARIATRIC SURGERY

Product	Product no.	Quantity	Catalog / Section
Clip applicator Ø 10 mm WL 340 mm	8389.911	1	Laparoscopy / 10
Ethicon® Ligaclips® (PACK= 108 PCS)	8389.915	1	Laparoscopy / 10
Needle holder Ø 5 mm bndl with carbide insert	8394.502	1	Laparoscopy / 11
Needle holder Ø 5 mm bndl curved to the right with carbide insert	8394.511	1	Laparoscopy / 11
Needle forceps Ø 2.45 mm WL 160 mm	8756.201	1	Laparoscopy / 11
Sealing cone Ø 12–15 mm	8943.915	1	Laparoscopy / 11
Sealing cone Ø 10–12 mm	8934.915	1	Laparoscopy / 11
VERES cannula Ø 2.1 mm WL 152 mm	8302.12	1	Laparoscopy / 3
Handle, axial, mono	83930084	1	Laparoscopy / 14
Rotatable knob	8988	1	Laparoscopy / 14
Connection cable			
Mono HF connection cable L 3 m	8106.033	1	Laparoscopy / 13
Bipo HF connection cable L 3 m	8108.132	1	Laparoscopy / 13

MINI FIBER TELESCOPES 2.0 MM

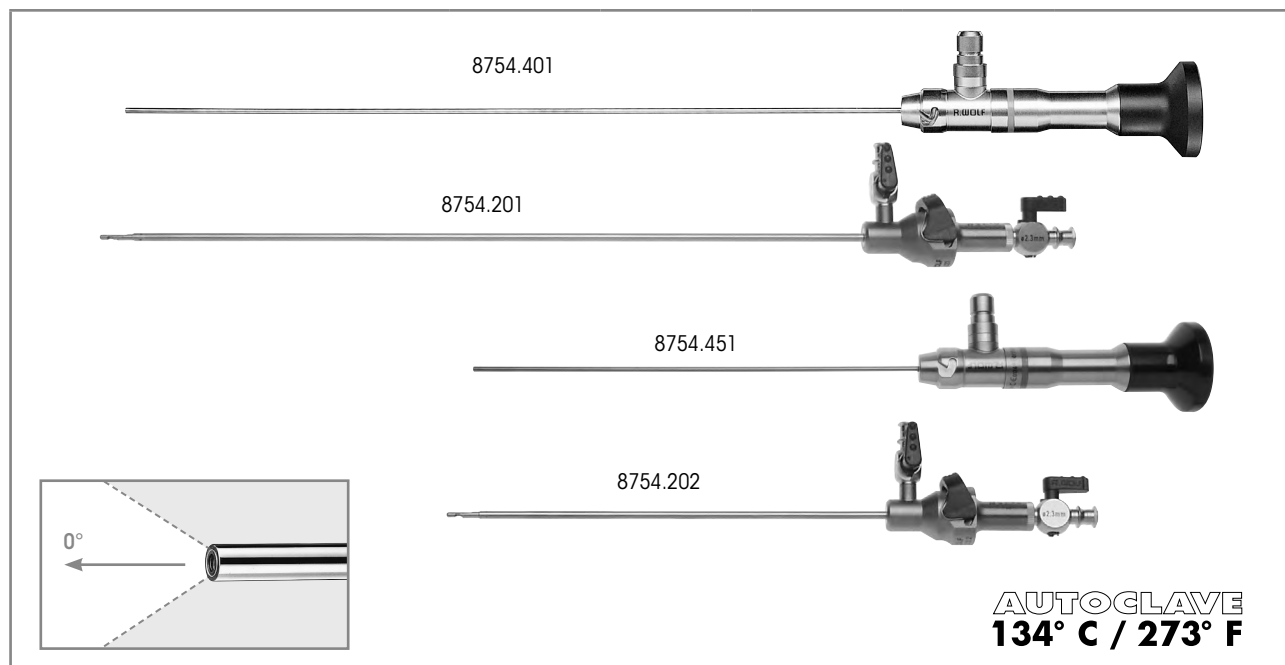

Long version	Direction of view	WL	TL	Ø	Product no.
Telescope 0° Ø 2 mm NL 268 mm	0°	268 mm	365 mm	2.0 mm	8754.401
for this:					
VERES cannula Ø 2.3 mm WL 250 mm consisting of: 1x VERES cannula Ø 2.3 mm WL 274 mm (8754.211) 1x outer sheath Ø 2.8 mm, WL 250 mm (8754.221)		250 mm		2.3 mm	8754.201
Short version	Direction of view	WL	TL	Ø	Product no.
Telescope 0° Ø 2 mm NL 158 mm	0°	158 mm	255 mm	2.0 mm	8754.451
for this:					
VERES cannula Ø 2.3 mm WL 170 mm consisting of: 1x VERES cannula Ø 2.3 mm WL 164 mm (8754.212) 1x outer sheath Ø 2.8 mm WL 141 mm (8754.222)		170 mm		2.3 mm	8754.202

Recommended accessories	Product no.
Perforated basket for standard telescope 1 (for telescope 8754.451)	(W x H x D) 297 x 54 x 59 mm 38015
Perforated basket for standard telescope 2 (for telescope 8754.401)	(W x H x D) 481 x 54 x 59 mm 38016
Fiber light cable bndl consisting of: Fiber light cable (80662523), projector-side adapter (8095.07), and endoscope-side adapter (809509)	Ø 2.5 mm, 2.3 m long 806625231

11123 || Subject to modifications. Please note that some products may not be available in all countries. Please always take note of the information that is provided with the product. For more detailed information, please consult with your contact partner or directly with Richard Wolf GmbH.

LAPAROSCOPES 3.5 MM

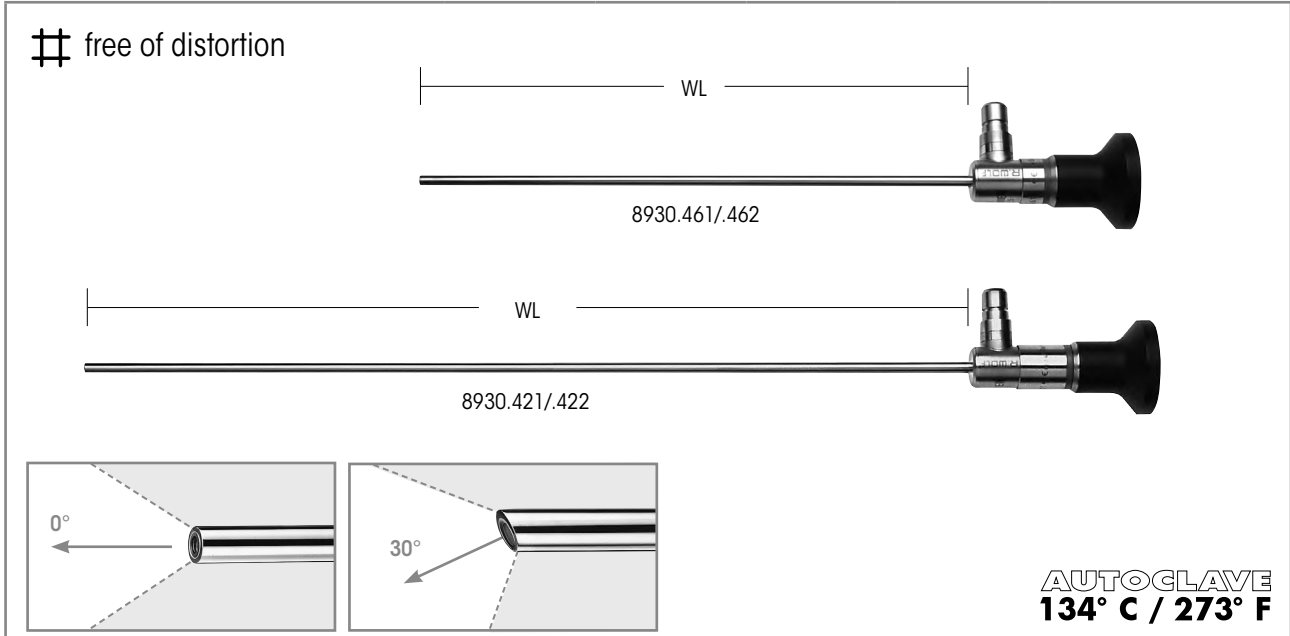

	Direction of view	WL	TL	Ø	Product no.
PANOVIEW PLUS Telescope 0° 3.5 mm WL 180 mm	0°	180 mm	232 mm	3.5 mm	8930.461
PANOVIEW PLUS Telescope 30° 3.5 mm WL 180 mm	30°		233 mm		8930.462
PANOVIEW PLUS Telescope 0° Ø 3.5 mm WL 300 mm	0°	300 mm	361 mm		8930.421
PANOVIEW PLUS Telescope 30° 3.5 mm WL 300 mm	30°		362 mm		8930.422

Recommended accessories		Product no.
Perforated basket for standard telescope 1 (for telescope 8930.461/.462)	(W x H x D) 297 x 54 x 59 mm	38015
Perforated basket for standard telescope 2 (for telescope 8930.421/.422)	(W x H x D) 481 x 54 x 59 mm	38016
Fiber light cable bndl consisting of: Fiber light cable (80662523), projector-side adapter (8095.07), and endoscope-side adapter (809509)	Ø 2.5 mm, 2.3 m long	806625231

III23 || Subject to modifications. Please note that some products may not be available in all countries. Please always take note of the information that is provided with the product. For more detailed information, please consult with your contact partner or directly with Richard Wolf GmbH.

LAPAROSCOPES 5.3 MM

free of distortion

full screen

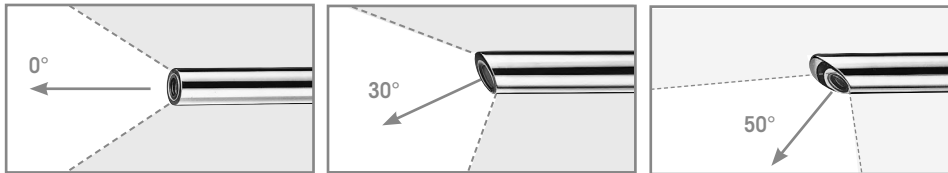

AUTOCLAVE
134° C / 273° F

	Direction of view	WL	TL	Ø	Product no.
PANOVIEW Telescope 0° Ø 5.3 mm WL 303 mm	0°	303 mm	372 mm	5.3 mm	8935.441
PANOVIEW Telescope 30° Ø 5.3 mm WL 303 mm	30°		373 mm		8935.442
PANOVIEW Telescope 50° Ø 5.3 mm WL 309 mm	50°	309 mm	377 mm		8935.443

Recommended accessories		Product no.
Perforated basket for standard telescope 2	(W x H x D) 481 x 54 x 59 mm	38016
Fiber light cable bndl consisting of: Fiber light cable (80662523), projector-side adapter (8095.07), and endoscope-side adapter (809509)	Ø 2.5 mm, 2.3 m long	806625231

11123 || Subject to modifications. Please note that some products may not be available in all countries. Please always take note of the information that is provided with the product. For more detailed information, please consult with your contact partner or directly with Richard Wolf GmbH.

MINI OR LAPAROSCOPE

5.5 MM WITH 3.5 MM WORKING CHANNEL

TELESCOPES

2

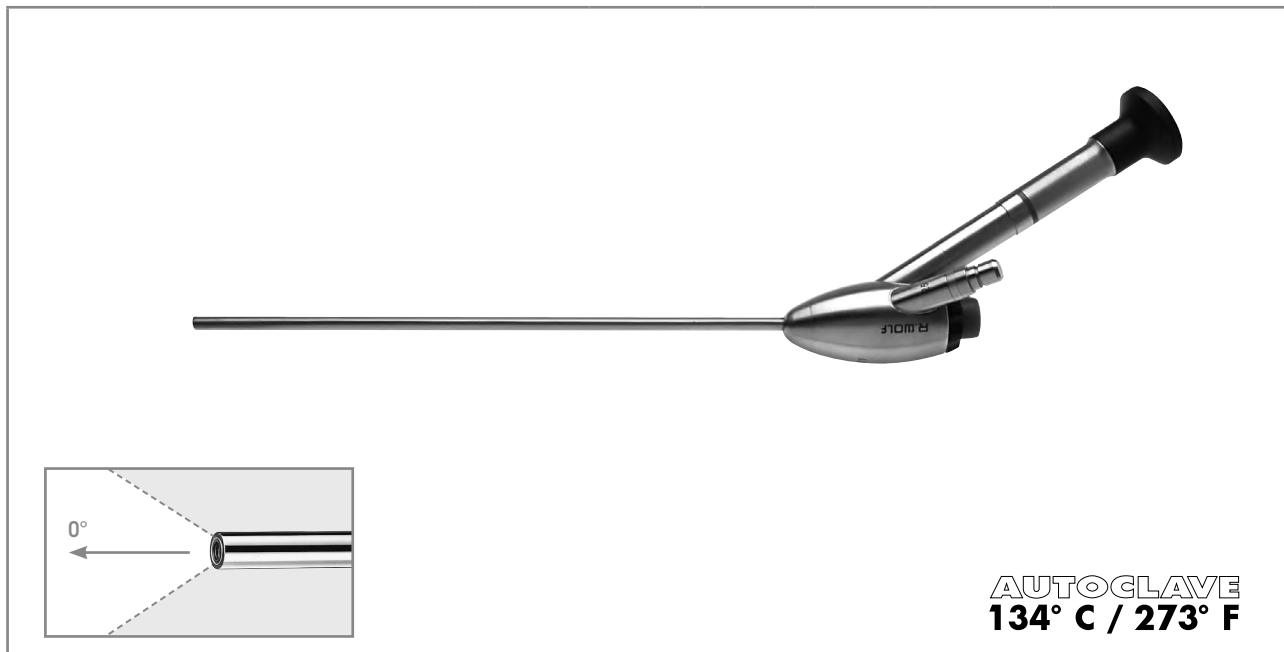

	Direction of view	SL	TL	Ø	Working channel Ø	Product no.
OR endoscope bndl consisting of: OR endoscope 0° Ø 5.5 mm SL 215 mm (8920.401) Autom. sealing element ID 5.7 mm (8920.311) Sealing cap, red-orange (15176.020) Sealing membrane Ø 17 mm (PACK= 10 PCS) (89.103)	0°	215 mm	370 mm	5.5 mm	3.5 mm	8920.4011

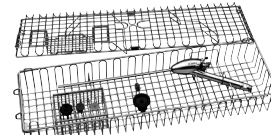
Recommended accessories		Product no.
Trocar sleeve, straight, capacity 5.5 mm WL 62 mm		8919.333
Trocar sleeve, straight, capacity 5.5 mm WL 102 mm		8919.353
Perforated basket for telescope Dimensions (W x L x H): 132 x 467 x 75 mm		38008
Fiber light cable bndl consisting of: Fiber light cable (80663523), projector-side adapter (8095.07), and endoscope-side adapter (809509)	Ø 3.5 mm, 2.3 m long	806635231

III23 || Subject to modifications. Please note that some products may not be available in all countries. Please always take note of the information that is provided with the product. For more detailed information, please consult with your contact partner or directly with Richard Wolf GmbH.

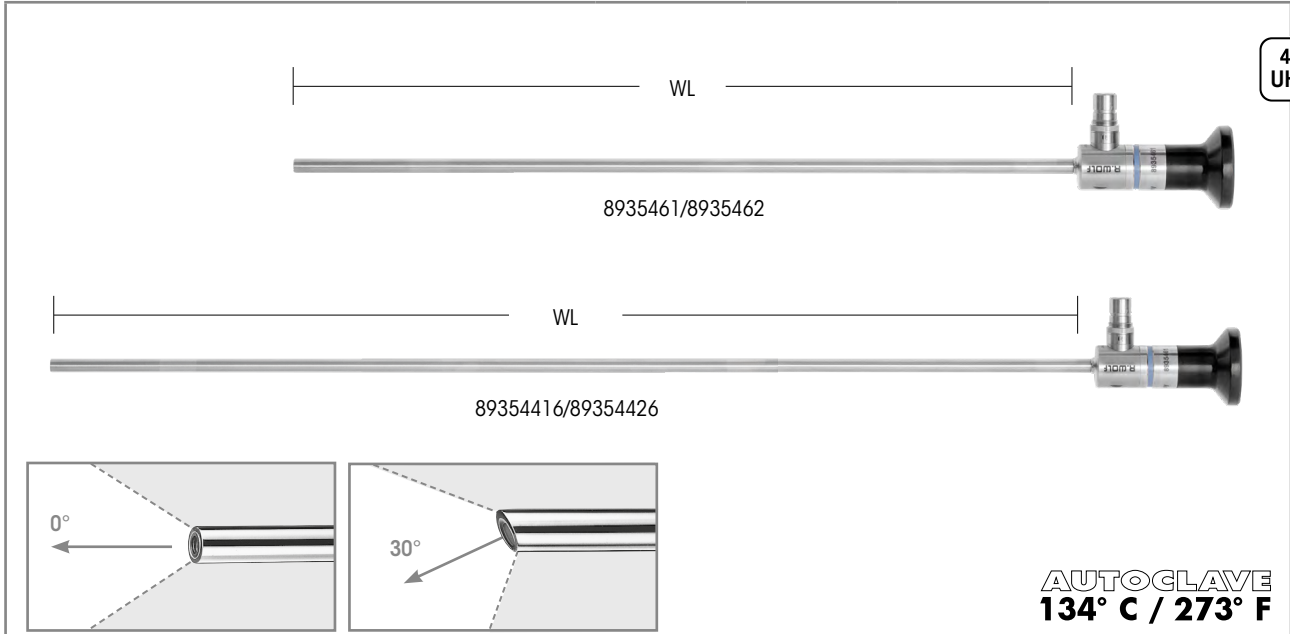

	Direction of view	WL	Ø	Product no.
PANOVIEW ULTRA Telescope Ø 5.5 mm WL 300 mm	0°	300 mm	5.5 mm	8935461
PANOVIEW ULTRA Telescope Ø 5.5 mm WL 300 mm	30°			8935462
PANOVIEW ULTRA Telescope Ø 5.5 mm WL 430 mm	0°	430 mm		89354416
PANOVIEW ULTRA Telescope Ø 5.5 mm WL 430 mm	30°			89354426

Recommended accessories		Product no.
Perforated basket for standard telescope 2 (for telescope 8935416/8935426)	(W x H x D) 481 x 54 x 59 mm	38016
Perforated basket for standard telescope 3 (for telescope 89354416/89354426)	(W x H x D) 619 x 54 x 59 mm	38017
Fiber light cable bndl consisting of: Fiber light cable (80663523), projector-side adapter (8095.07), and endoscope-side adapter (809509)	Ø 3.5 mm, 2.3 m long	806635231

11123 || Subject to modifications. Please note that some products may not be available in all countries. Please always take note of the information that is provided with the product. For more detailed information, please consult with your contact partner or directly with Richard Wolf GmbH.

LAPAROSCOPES 10 MM

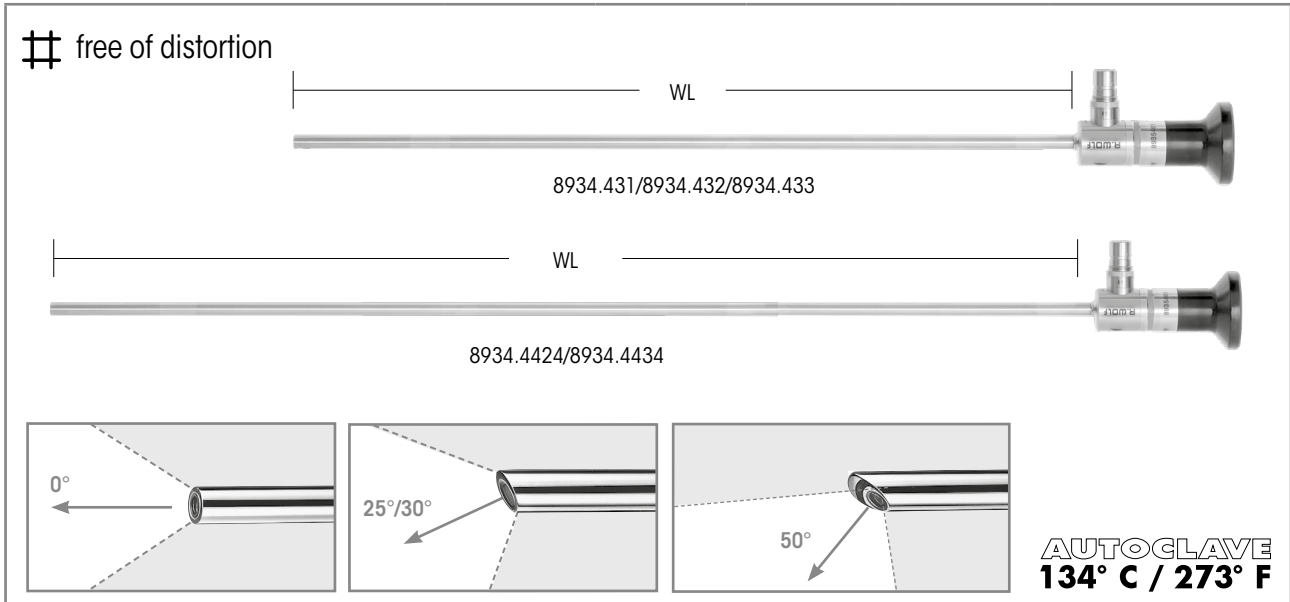

	Direction of view	WL	TL	Ø	Product no.
PANOVIEW Telescope 0° Ø 10 mm WL 307 mm	0°	307 mm	375 mm	10 mm	8934.431
PANOVIEW Telescope 30° Ø 10 mm WL 307 mm	30°	307 mm	375 mm		8934.432
PANOVIEW Telescope 50° Ø 10 mm WL 310 mm	50°	310 mm	378 mm		8934.433
PANOVIEW PLUS Telescope 25° Ø 10 mm WL 438 mm	25°	438 mm	507 mm		8934.4424
PANOVIEW PLUS Telescope 50° Ø 10 mm WL 447 mm	50°	447 mm	516 mm		8934.4434

Recommended accessories		Product no.
Perforated basket for standard telescope 2 (for telescope 8934.431/.432/.433)	(W x H x D) 481 x 54 x 59 mm	38016
Perforated basket for standard telescope 3 (for telescope 8934.4424/.4434)	(W x H x D) 619 x 54 x 59 mm	38017
Fiber lightcable bndl consisting of: Fiber light cable Ø 5 mm TL 2.3 m (80665023), projector-side adapter (8095.07), and endoscope-side adapter (809509)	Ø 5.0 mm, 2.3 m long	806650231
Fusion Fiber light cable bndl consisting of: Fiber light cable Ø 5 mm TL 2.3 m (80655023), projector-side adapter (8095.07), and endoscope-side adapter (809509)	Ø 5.0 mm, 2.3 m long	806550231

III23 || Subject to modifications. Please note that some products may not be available in all countries. Please always take note of the information that is provided with the product. For more detailed information, please consult with your contact partner or directly with Richard Wolf GmbH.

3D ENDOSCOPE 10 MM

free of distortion

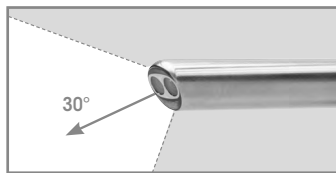
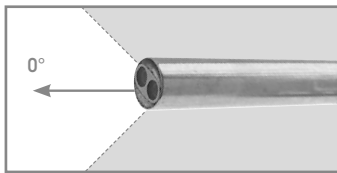
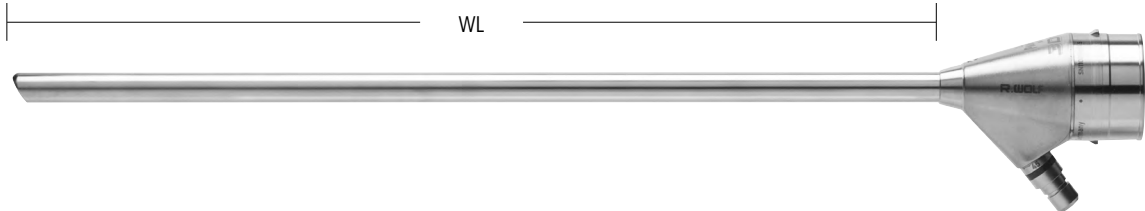

AUTOCLAVE
134° C / 273° F

	Direction of view	WL	TL	Ø	Product no.
3D endoscope 0° Ø 10 mm WL 300 mm	0°	300 mm	366 mm	10 mm	8934631
3D endoscope 0° Ø 10 mm WL 435 mm		435 mm	500 mm		89344631
3D endoscope 30° Ø 10 mm WL 301 mm	30°	301 mm	366 mm		8934632
3D endoscope 30° Ø 10 mm WL 435 mm		435 mm	501 mm		89344632

Recommended accessories		Product no.
Perforated basket for 3D telescope 	(W x H x D): 583 x 200 x 80 mm	38014
Fusion Fiber light cable bndl consisting of: Fiber light cable Ø 5 mm TL 2.3 m (80655023), projector-side, adapter (8095.07), and endoscope-side adapter (809509)	Ø 5.0 mm, 2.3 m long	806550231

||123 || Subject to modifications. Please note that some products may not be available in all countries. Please always take note of the information that is provided with the product. For more detailed information, please consult with your contact partner or directly with Richard Wolf GmbH.

SURGICAL LAPAROSCOPE 10 MM

FOR ONE HOLE APPENDECTOMY

TELESCOPES

2

free of distortion

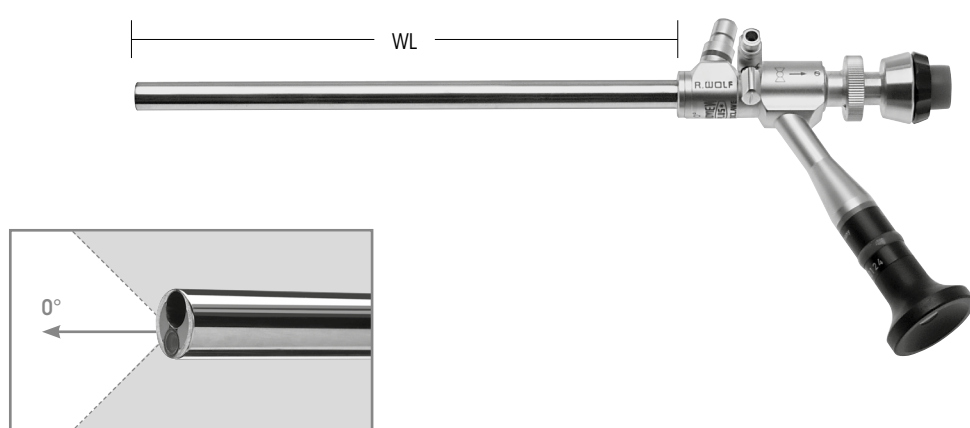

AUTOCLAVE
134° C / 273° F

	Direction of view	WL	TL	Ø	Working channel Ø	Product no.
PANOVIEW PLUS OR endoscope 0° Ø 10 mm WL 188 mm with lateral eyepiece	0°	188 mm	285 mm	10 mm	5.1 mm	8915.501

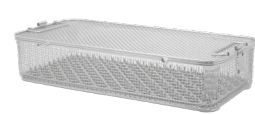
Recommended accessories		Product no.
Universal perforated basket 4 (W x H x D): 538 x 117 x 250 mm		33004
for this: Instrument mat for perforated basket		33001
Fiber light cable bndl consisting of: Fiber light cable Ø 5 mm TL 2.3 m (80655023), projector-side adapter (8095.07), and endoscope-side adapter (809509)	Ø 5.0 mm, 2.3 m long	806650231
Fusion Fiber light cable bndl consisting of: Fiber light cable Ø 5 mm TL 2.3 m (80655023), projector-side adapter (8095.07), and endoscope-side adapter (809509)	Ø 5.0 mm, 2.3 m long	806550231

III23 || Subject to modifications. Please note that some products may not be available in all countries. Please always take note of the information that is provided with the product. For more detailed information, please consult with your contact partner or directly with Richard Wolf GmbH.



AUTOCLAVE
134° C / 273° F



	Direction of view	WL	TL	Ø	Product no.
PANOVIEW ULTRA Telescope 0° Ø 10 mm WL 305 mm	0°	305 mm	375 mm	10 mm	8934461
PANOVIEW ULTRA Telescope 30° Ø 10 mm WL 305 mm	30°				8934462
PANOVIEW ULTRA Telescope 50° Ø 10 mm WL 305 mm	50°				8934463

Note: Compatible with System green (see Imaging Catalog) (ICG/NIR-capable) and its recommended Fusion fiber light cable

Recommended accessories		Product no.
Perforated basket for standard telescope 2	(W x H x D) 481 x 54 x 59 mm	38016
Fiber lightcable bndl consisting of: Fiber light cable Ø 5 mm TL 2.3 m (80665023), projector-side adapter (8095.07), and endoscope-side adapter (809509)	Ø 5.0 mm, 2.3 m long	806650231
Fusion fiber lightcable bndl consisting of: Fiber light cable Ø 5 mm TL 2.3 m (80655023), projector-side adapter (8095.07), and endoscope-side adapter (809509)	Ø 5.0 mm, 2.3 m long	806550231



AUTOCLAVE
134° C / 273° F

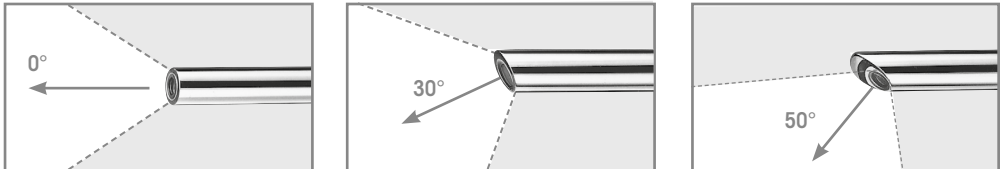

	Direction of view	WL	TL	Ø	Product no.
PANOVIEW ULTRA Telescope 0° Ø 10 mm WL 440 mm	0°	440 mm	510 mm	10 mm	89344416
PANOVIEW ULTRA Telescope 30° Ø 10 mm WL 440 mm	30°				89344426
PANOVIEW ULTRA Telescope 50° Ø 10 mm WL 440 mm	50°				89344436

Note: Compatible with System green (see Imaging Catalog) (ICG/NIR-capable) and its recommended Fusion fiber light cable

Recommended accessories		Product no.
Perforated basket for standard telescope 3	(W x H x D) 619 x 54 x 59 mm	38017
Fiber lightcable bndl consisting of: Fiber light cable Ø 5 mm TL 2.3 m (80665023), projector-side adapter (8095.07), and endoscope-side adapter (809509)	Ø 5.0 mm, 2.3 m long	806650231
Fusion Fiber light cable bndl consisting of: Fiber light cable Ø 5 mm TL 2.3 m (80655023), projector-side adapter (8095.07), and endoscope-side adapter (809509)	Ø 5.0 mm, 2.3 m long	806550231

III23 || Subject to modifications. Please note that some products may not be available in all countries. Please always take note of the information that is provided with the product. For more detailed information, please consult with your contact partner or directly with Richard Wolf GmbH.

**LIGHT TUBE FOR MILOS METHOD
(MINI LESS OPEN SUBLAY METHOD)**



AUTOCLAVE
134° C / 273° F



		Ø	TL	Product no.
	<p>Light tube for MILOS method Ø 10 mm Instrument channel for 5 mm instruments</p>	10 mm	200 mm	893420

Recommended accessories		Product no.
<p>Fiber light cable bndl consisting of: Fiber light cable Ø 5 mm, TL 2.3 m (80665023), projector-side adapter (8095.07), and endoscope-side adapter (809509)</p>	Ø 5.0 mm, 2.3 m long	806650231
<p>Fusion Fiber light cable bndl consisting of: Fiber light cable Ø 5 mm, TL 2.3 m (80655023), projector-side adapter (8095.07), and endoscope-side adapter (809509)</p>	Ø 5.0 mm, 2.3 m long	806550231
<p>Sealing cap, sulfur yellow, cap. 1.3 mm</p>		8934201



11123 || Subject to modifications. Please note that some products may not be available in all countries. Please always take note of the information that is provided with the product. For more detailed information, please consult with your contact partner or directly with Richard Wolf GmbH.



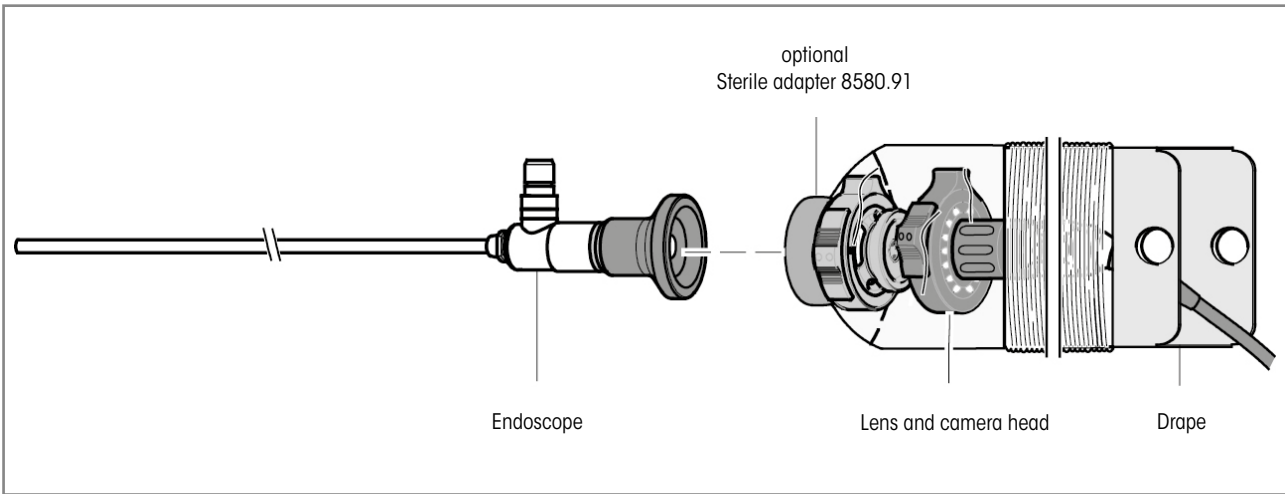

LAPAROSCOPES
ACCESSORIES

			Product no.
	Sterile adapter	immersible and autoclavable for changing telescopes	8580.91



TROCAR SLEEVES 2.2 / 2.5 MM

				Tip triangular	
				Trocar tip triangular Size 2.2 mm	
Plastic sheath tube with thread	WL	Capacity	Product no.	WL 82 mm	
Trocar sleeve capacity 2.2 mm WL 60 mm with universal sealing valve	 60 mm	2.2 mm	8309.072	8309.121	

Trocar sleeve with insufflation connector						Tip triangular	
Stainless steel sheath tube, smooth		WL	Capacity	Product no.	WL 82 mm		
Trocar sleeve capacity 2.5 mm WL 55 mm	 55 mm	2.5 mm	8309.012	8309.121			
				WL 119 mm			
Trocar sleeve capacity 2.5 mm WL 95 mm	 95 mm	2.5 mm	8309.014	8309.123			

Accessories	Product no.
Rubber cap capacity 0.8 mm (PACK= 10 PCS) red	88.01



11123 || Subject to modifications. Please note that some products may not be available in all countries. Please always take note of the information that is provided with the product. For more detailed information, please consult with your contact partner or directly with Richard Wolf GmbH.

TROCAR SLEEVES 3.5 MM

WITH INSUFFLATION STOPCOCK

TROCAR SLEEVES

3







RIWO-ART trocar sleeves with magnetic ball valve with insufflation stopcock				Tip tapered/blunt	Tip triangular
					
				Trocar tip blunt Size 3.5 mm	Trocar tip triangular Size 3.5 mm
Stainless steel sheath tube, smooth	WL	Capacity	Product no.	WL 169 mm	WL 169 mm
Trocar sleeve straight capacity 3.5 mm WL 100 mm	100 mm	3.5 mm	8903.014	8903.103	8903.123
Plastic sheath tube with thread					
Trocar sleeve straight capacity 3.5 mm WL 100 mm	100 mm	3.5 mm	8903.034	8903.103	8903.123
				WL 129 mm	WL 129 mm
Trocar sleeve slanted capacity 3.5 mm WL 60 mm	60 mm	3.5 mm	8903.072	8903.101	8903.121

Accessories	Product no.
Spare ball capacity 5.5 mm	8921.901
Spare O rings capacity 3.5 mm (PACK= 10 PCS), capacity Ø 3.5–5.5 mm	8921.951
Sealing cap capacity 2.4–3.4 mm (PACK= 10 PCS) red	89.01
Stopcock insert bndl cap. 3.0 mm (PACK= 5 PCS)	896.0002

Trocar sleeve with membrane valve				Tip tapered/blunt	
				Trocar tip blunt Size 3.5 mm	
Plastic sheath tube with distal screw anchor	WL	Capacity	Product no.	WL 169 mm	
Trocar sleeve straight capacity 3.5 mm WL 40 mm	40 mm	3.5 mm	8929.223	8903.103	



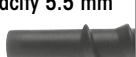



III23 || Subject to modifications. Please note that some products may not be available in all countries. Please always take note of the information that is provided with the product. For more detailed information, please consult with your contact partner or directly with Richard Wolf GmbH.

TROCAR SLEEVES 5.5 MM

RIWO-ART trocar sleeves with magnetic ball valve with insufflation stopcock 				Tip tapered/blunt	Tip tapered/ pointed	Tip triangular
				Trocar tip blunt Size 5.5 mm	Trocar tip pointed Size 5.5 mm	Trocar tip triangular Size 5.5 mm
Stainless steel sheath tube	WL	Capacity	Product no.	WL 169 mm	WL 169 mm	WL 169 mm
Trocar sleeve straight capacity 5.5 mm WL 100 mm smooth 	100 mm	5.5 mm	8921.014	8921.103	8921.113	8921.123
Trocar sleeve slanted capacity 5.5 mm WL 100 mm smooth 	100 mm	5.5 mm	8921.013	8921.103	8921.113	8921.123
Trocar sleeve straight capacity 5.5 mm WL 100 mm with thread 	100 mm	5.5 mm	8921.024	8921.103	8921.113	8921.123
Trocar sleeve slanted capacity 5.5 mm WL 100 mm with thread 	100 mm	5.5 mm	8921.023	8921.103	8921.113	8921.123
Plastic tube Trocar sleeve straight capacity 5.5 mm WL 100 mm with thread 	100 mm	5.5 mm	8921.034	8921.103	8921.113	8921.123
				WL 219 mm	WL 219 mm	WL 219 mm
Trocar sleeve straight capacity 5.5 mm WL 150 mm smooth 	150 mm	5.5 mm	8921.016	8921.105	8921.115	8921.125
Trocar sleeve straight capacity 5.5 mm WL 150 mm with thread 	150 mm	5.5 mm	8921.026	8921.105	8921.115	8921.125

Accessories	Product no.
Spare ball capacity 5.5 mm	8921.901
Spare O rings capacity 3.5 mm (PACK= 10 PCS), capacity Ø 3.5–5.5 mm	8921.951
Sealing cap capacity 3.4–5.1 mm (PACK= 10 PCS) blue	89.02
Stopcock insert bndl cap. 3.0 mm (PACK= 5 PCS)	896.0002

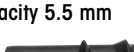
TROCAR SLEEVES 5.5 MM





RIWO-ART trocar sleeves with magnetic ball valve 				Tip tapered/blunt	Tip tapered/ pointed	Tip triangular	
				Trocar tip blunt Size 5.5 mm	Trocar tip pointed Size 5.5 mm	Trocar tip triangular Size 5.5 mm	
Stainless steel sheath tube		WL	Capacity	Product no.	WL 129 mm	WL 129 mm	WL 129 mm
Trocar sleeve straight capacity 5.5 mm WL 60 mm smooth 		60 mm	5.5 mm	8921.052	8921.101	8921.111	8921.121
Trocar sleeve slanted capacity 5.5 mm WL 60 mm smooth 		60 mm	5.5 mm	8921.051	8921.101	8921.111	8921.121
Trocar sleeve straight capacity 5.5 mm WL 60 mm with thread 		60 mm	5.5 mm	8921.062	8921.101	8921.111	8921.121
Trocar sleeve slanted capacity 5.5 mm WL 60 mm with thread 		60 mm	5.5 mm	8921.061	8921.101	8921.111	8921.121
Plastic tube Trocar sleeve straight capacity 5.5 mm WL 60 mm with thread 		60 mm	5.5 mm	8921.072	8921.101	8921.111	8921.121
					WL 169 mm	WL 169 mm	WL 169 mm
Trocar sleeve straight capacity 5.5 mm WL 100 mm smooth 		100 mm	5.5 mm	8921.054	8921.103	8921.113	8921.123
Trocar sleeve straight capacity 5.5 mm WL 100 mm with thread 		100 mm	5.5 mm	8921.053	8921.103	8921.113	8921.123

Accessories	Product no.
Spare ball capacity 5.5 mm	8921.901
Spare O rings capacity 3.5 mm (PACK= 10 PCS), capacity Ø 3.5–5.5 mm	8921.951
Sealing cap capacity 3.4–5.1 mm (PACK= 10 PCS) blue	89.02

TROTEC

TROCAR WITH AUTOMATIC PROTECTIVE FUNCTION

FOR TROCAR SLEEVES 5.5 MM

Trocar consisting of:		Product no.	for RIWO-ART trocar sleeve with WL 100 mm, Ø 5,5 mm
Sheath with trocar tip Size 5.5 mm WL 181 mm	Tapered tip 	8921.132	
Sheath with trocar tip Size 5.5 mm WL 181 mm	Two-sided tip 	8921.134	
Spring-loaded protective rod WL 184 mm		8923.135	

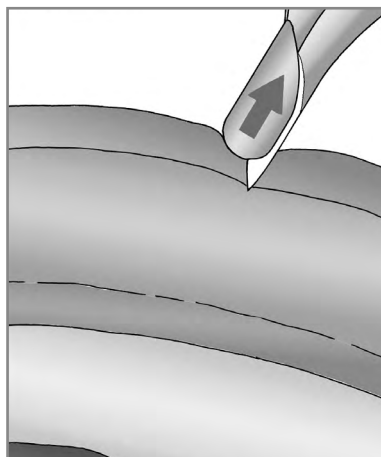

Protective tip automatically pushes back into the cannula through contact with the abdominal wall

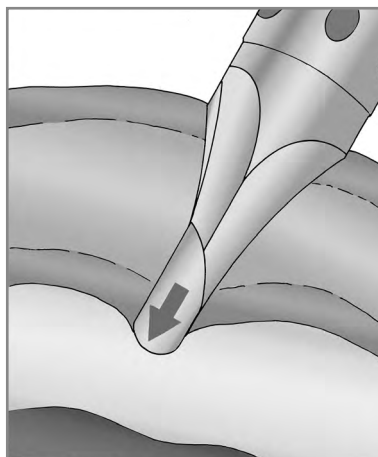

The protective tip advances into the free abdomen immediately after penetration of the peritoneum

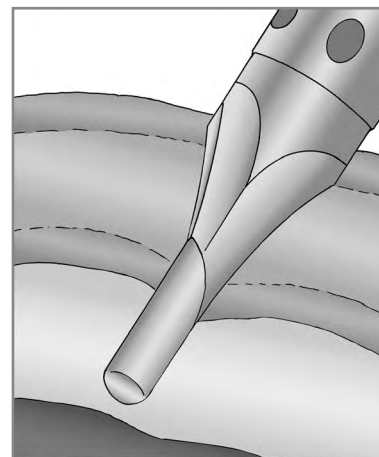





The atraumatic protective tip in a far distal position prevents perforation of organs and vessels

TROCAR SLEEVE 5.5 MM/5.8 MM

PLASTIC WITH SEALING MEMBRANE

TROCAR SLEEVES

3

 <p>AUTOCLAVE 134° C / 273° F</p>					Tip tapered/blunt	Tip tapered/pointed	Tip triangular
							
					Trocar tip blunt Size 5.5 mm	Trocar tip pointed Size 5.5 mm	Trocar tip triangular Size 5.5 mm
Flexible plastic sheath tube with thread	WL	Capacity	with stopcock	Product no.	WL 104 mm	WL 104 mm	WL 104 mm
Trocar sleeve straight capacity 5.5 mm WL 62 mm with membrane valve	62 mm	5.5 mm	●	8919.333	8919.3311	8919.3312	8919.3313
				8919.331			
					WL 144 mm	WL 144 mm	WL 144 mm
Trocar sleeve straight capacity 5.5 mm WL 102 mm with membrane valve	102 mm	5.5 mm	●	8919.353	8919.3511	8919.3512	8919.3513
				8919.351			

for curved instruments				Tip tapered/blunt	Tip tapered/pointed	Tip triangular	Tip tapered/blunt
 <p>AUTOCLAVE 134° C / 273° F</p>							
				Trocar tip blunt Size 5.5 mm	Trocar tip pointed Size 5.5 mm	Trocar tip triangular Size 5.5 mm	Trocar tip blunt Size 5.5 mm
Flexible plastic sheath tube with thread	WL	Capacity	Product no.	WL 80 mm	WL 80 mm	WL 80 mm	WL 80 mm
Trocar sleeve straight capacity 5.8 mm WL 62 mm with membrane valve	62 mm	5.8 mm	8905.331	8905.3311	8905.3312	8905.3313	8905.3315
				WL 120 mm	WL 120 mm	WL 120 mm	WL 120 mm
Trocar sleeve straight capacity 5.8 mm WL 102 mm with membrane valve	102 mm	5.8 mm	8905.3515	8905.3511	8905.3512	8905.3513	8905.3515

Accessories	Product no.
Sealing membrane Ø 17 mm, yellow (PACK= 10 PCS)	89.103
Stopcock insert bndl cap 3.0 mm (PACK= 5 PCS)	896.0002

11123 || Subject to modifications. Please note that some products may not be available in all countries. Please always take note of the information that is provided with the product. For more detailed information, please consult with your contact partner or directly with Richard Wolf GmbH.

TROCAR SLEEVE 5.7 MM/7 MM/10 MM/12.5 MM









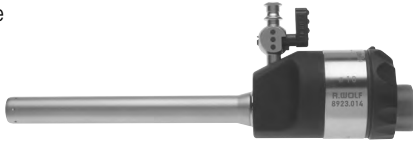

FLEXIBLE PLASTIC SHEATH TUBE

				Tip tapered/blunt
				Trocar tip blunt
Flexible plastic sheath tube with thread	WL	Capacity	Product no.	Size 5.5 mm/WL 83 mm
Trocar sleeve straight capacity 5.7 mm WL 60 mm with rubber cap	60 mm	5.7 mm	8906.051	8906.151

				Tip tapered/blunt
				Trocar tip blunt
Ribbed flexible plastic sheath tube	WL	Capacity	Product no.	Size 7.3 mm/TL 108 mm
Trocar sleeve flexible capacity 7 mm WL 74 mm with universal seal	74 mm	7 mm	8906.001	8913.11
				Size 10 mm/TL 85 mm
Trocar sleeve flexible capacity 10 mm WL 56 mm with universal seal	56 mm	10 mm	8906.011	8906.111
				Size 12.5 mm/TL 86 mm
Trocar sleeve flexible capacity 12.5 mm WL 57 mm with universal seal	57 mm	12.5 mm	8906.031	8906.131

TROCAR SLEEVE 10 MM

WITH INSUFFLATION STOPCOCK





RIWO-ART trocar sleeves with magnetic ball valve 					Tip tapered/blunt	Tip tapered/pointed	Tip triangular
					 Trocar tip blunt Size 10 mm	 Trocar tip pointed Size 10 mm	 Trocar tip triangular Size 10 mm
Stainless steel sheath tube		WL	Capacity	Product no.	WL 164 mm	WL 164 mm	WL 164 mm
Trocar sleeve straight capacity 10 mm WL 100 mm		100 mm	10 mm	8923.014	8923.103	8923.113	8923.123
Trocar sleeve slanted capacity 10 mm WL 100 mm		100 mm	10 mm	8923.013	8923.103	8923.113	8923.123
Trocar sleeve straight capacity 10 mm WL 100 mm with thread		100 mm	10 mm	8923.024	8923.103	8923.113	8923.123
Trocar sleeve slanted capacity 10 mm WL 100 mm with thread		100 mm	10 mm	8923.023	8923.103	8923.113	8923.123
					WL 214 mm	WL 214 mm	WL 214 mm
Trocar sleeve straight capacity 10 mm WL 150 mm		150 mm	10 mm	8923.016	-	8923.115	8923.125
Trocar sleeve straight capacity 10 mm WL 150 mm with thread		150 mm	10 mm	8923.026	-	8923.115	8923.125

Accessories	Product no.
Spare ball capacity 7 mm	8923901
Spare O rings capacity 7 mm (PACK= 10 PCS), capacity Ø 7–12.5 mm	8923951
Sealing cap capacity 9.5–10.1 mm (PACK= 10 PCS) red	8908
Stopcock insert bndl cap. 3.0 mm (PACK= 5 PCS)	896.0002

TROTEC

TROCAR WITH AUTOMATIC PROTECTIVE FUNCTION

FOR TROCAR SLEEVES 10 MM

Trocar consisting of:		Product no.	for RIWO-ART trocar sleeve with WL 100 mm, ø 10 mm
Sheath with trocar tip Size 10 mm WL 181 mm	Tapered tip 	8923.132	
Sheath with trocar tip Size 10 mm WL 181 mm	Two-sided tip 	8923.134	
Spring-loaded protective rod WL 184 mm		8923.135	

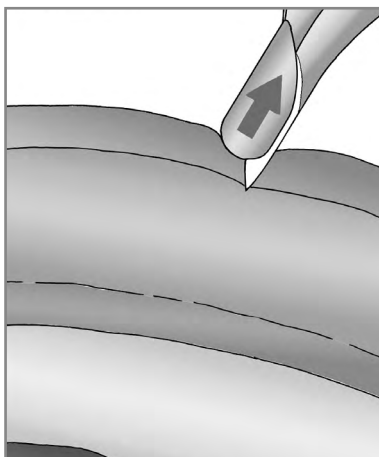

Protective tip automatically pushes back into the cannula through contact with the abdominal wall

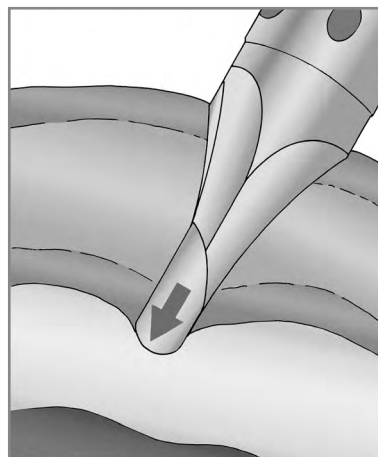

The protective tip advances into the free abdomen immediately after penetration of the peritoneum

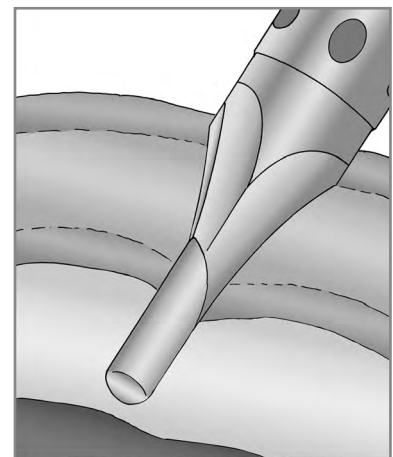



The atraumatic protective tip in a far distal position prevents perforation of organs and vessels

HIGH FLOW TROCAR SLEEVE 10 MM WITH CONNECTOR FOR HIGH FLOW INSUFFLATION TUBE

TROCAR SLEEVES

3







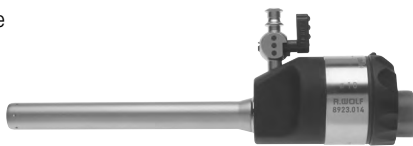

RIWO-ART trocar sleeves with magnetic ball valve 				Tip tapered/blunt	Tip tapered/pointed	Tip triangular		
								
				Trocar tip blunt Size 10 mm	Trocar tip pointed Size 10 mm	Trocar tip triangular Size 10 mm		
Stainless steel sheath tube		WL	Capacity	Product no.	WL 164 mm	WL 164 mm	WL 164 mm	
Trocar sleeve straight capacity 10 mm WL 100 mm			100 mm	10 mm	8923.042	8923.103	8923.113	8923.123
for this:						Product no.		
Reducing adapter (PACK= 5 PCS)			for reduction from Ø 7 mm, Ø 10 mm, and Ø 12.5 mm to Ø 5.5 mm			8923802		

Accessories	Product no.
Spare ball capacity 7 mm	8923901
Spare O rings capacity 7 mm (PACK= 10 PCS), capacity Ø 7–12.5 mm	8923951
Sealing cap capacity 9.5–10.1 mm (PACK= 10 PCS) red	8908

11123 || Subject to modifications. Please note that some products may not be available in all countries. Please always take note of the information that is provided with the product. For more detailed information, please consult with your contact partner or directly with Richard Wolf GmbH.



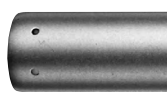

TROCAR SLEEVE 12.5 MM

WITH INSUFFLATION STOPCOCK

RIWO-ART trocar sleeves with magnetic ball valve 				Tip tapered/blunt 	Tip tapered/pointed 	Tip triangular 	
				Trocar tip blunt Size 12.7 mm	Trocar tip pointed Size 12.7 mm	Trocar tip triangular Size 12.7 mm	
Stainless steel sheath tube		WL	Capacity	Product no.	WL 164 mm	WL 164 mm	WL 164 mm
Trocar sleeve straight capacity 12.5 mm WL 100 mm 		100 mm	12.5 mm	8924.014	8924.103	8924.113	8924.123
Trocar sleeve slanted capacity 12.5 mm WL 100 mm 		100 mm	12.5 mm	8924.013	8924.103	8924.113	8924.123
					WL 214 mm	WL 214 mm	WL 214 mm
Trocar sleeve straight capacity 12.5 mm WL 150 mm with thread 		150 mm	12.5 mm	8924.026	-	8924.115	8924.125
Trocar sleeve straight capacity 12.5 mm WL 150 mm 		150 mm	12.5 mm	8924.016	-	8924.115	8924.125
for this:							
Reducing adapter (PACK= 5 PCS) 		for reduction from Ø 10 mm to Ø 5.5 mm and Ø 12.5 mm to Ø 5.5 mm				8923.802	
		for reduction from Ø 12.5 mm to Ø 10 mm				8924.802	

Accessories	Product no.
Spare ball capacity 7 mm	8923.901
Spare O rings capacity 7 mm (PACK= 10 PCS), capacity Ø 7–12.5 mm	8923.951
Sealing cap capacity 9.5–10.1 mm (PACK= 10 PCS) red	89.08
Stopcock insert bndl cap. 3.0 mm (PACK= 5 PCS)	896.0002

TROTEC
TROCAR WITH AUTOMATIC PROTECTIVE FUNCTION
 FOR TROCAR SLEEVES 12.5 MM

			
Trocar consisting of:		Product no.	for RIWO-ART trocar sleeve with WL 100 mm, Ø 12,5 mm
Sheath with trocar tip Size 12.5 mm WL 181 mm	Two-sided tip 	8924.134	
Spring-loaded protective rod WL 184 mm		8923.135	

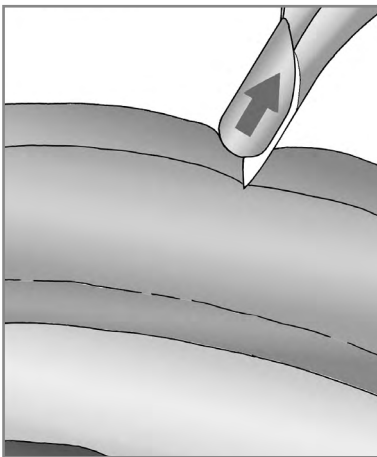

Protective tip automatically pushes back into the cannula through contact with the abdominal wall

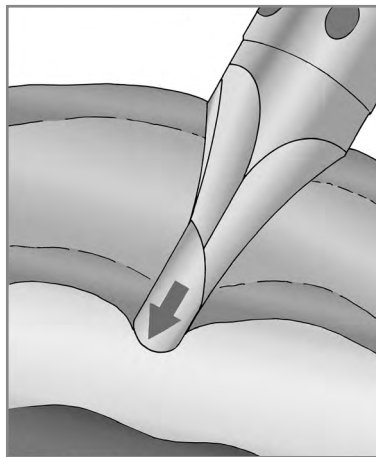

The protective tip advances into the free abdomen immediately after penetration of the peritoneum

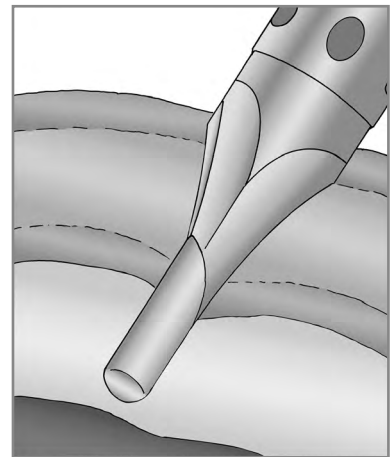

The atraumatic protective tip in a far distal position prevents perforation of organs and vessels

DILATATION AND EXTRACTION INSTRUMENTS

5.5 TO 10/10 TO 12.5 MM

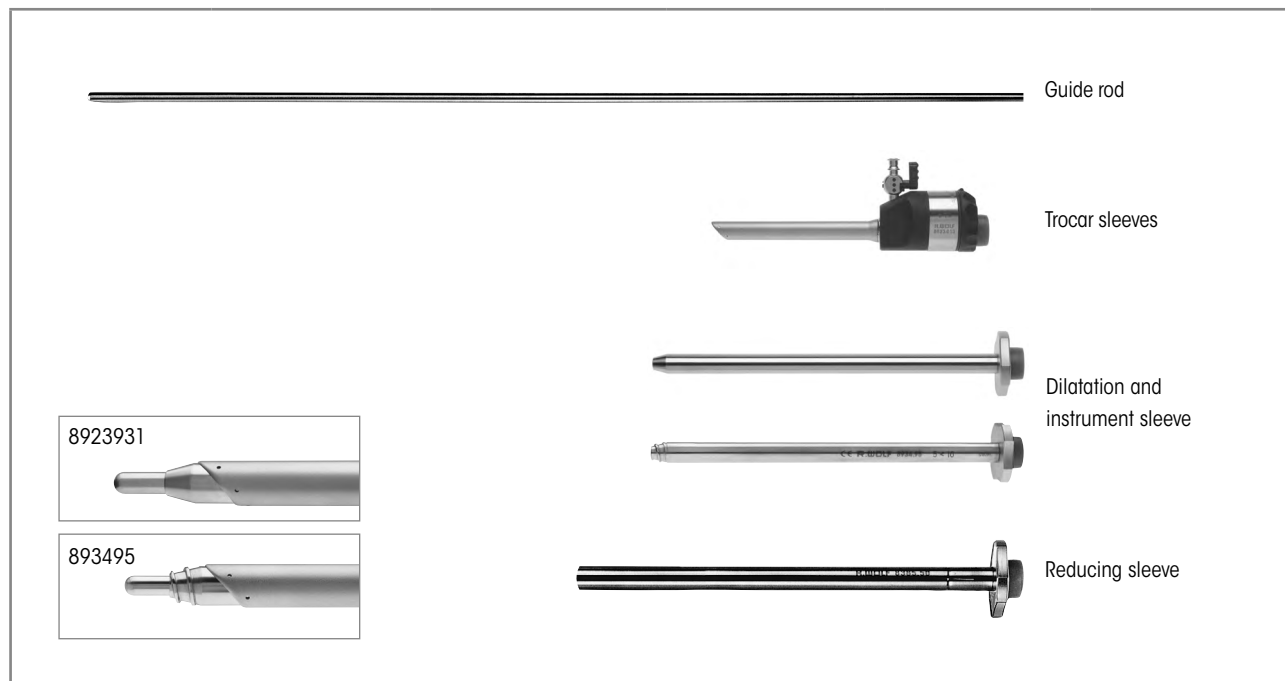

Incision widening	Guide rod	Trocar sleeve slanted	Dilatation sleeve	Instrument sleeve	Reducing sleeve
3.5 mm < 5.5 mm	-	8921.013 capacity 5.5 mm WL 100 mm			8383.78 Size 5 mm L 155 mm
5.5 mm < 10 mm	8923.921 5.5 mm TL 500 mm	8923.013 capacity 10 mm WL 100 mm	8923.931 Size 10 mm WL 170 mm	8385.50 10 mm WL 170 mm	
5.0 mm < 10 mm	8934.951 5 mm TL 500 mm		8934.95 Size 10 mm WL 172 mm		
10 mm < 12.5 mm		8924.013 capacity 12.5 mm WL 100 mm			8941.901 12 mm WL 180 mm
5.5 mm < 12.5 mm					8941.951 12 mm WL 180 mm
10 mm < 15 mm	8943.901 10 mm TL 500 mm				

11123 || Subject to modifications. Please note that some products may not be available in all countries. Please always take note of the information that is provided with the product. For more detailed information, please consult with your contact partner or directly with Richard Wolf GmbH.

REDUCING SLEEVES FOR RIWO-ART TROCAR SLEEVES

TROCAR SLEEVES

3

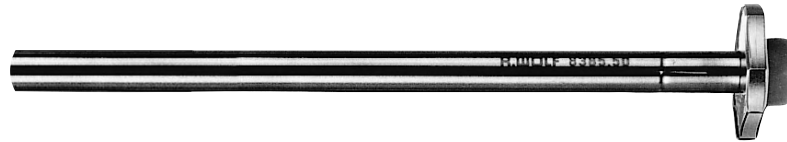



Stainless steel sheath tube	Outer Ø	WL	for instruments	Product no.
Reducing sleeve Size 5 mm WL 155 mm	5 mm	155 mm	3.5 mm	8383.78
Instrument sleeve 10 mm WL 170 mm	10 mm	170 mm	5.5 mm	8385.50
Reducing sleeve 12 mm WL 180 mm	12 mm	180 mm	10 mm	8941.901
Reducing sleeve 12 mm WL 180 mm	12 mm	180 mm	5.5 mm	8941.951
for this:				
Reducing adapter (PACK= 5 PCS)		for reduction from Ø 7 mm, Ø 10 mm, and Ø 12.5 mm to Ø 5.5 mm		8923802
		for reduction from Ø 12.5 mm to Ø 10 mm		8924802

Accessories	Product no.
Sealing cap capacity 3.4–5.1 mm (PACK= 10 PCS) blue	89.02
Sealing cap capacity 9.5–10.1 mm (PACK= 10 PCS) red	8908

III23 || Subject to modifications. Please note that some products may not be available in all countries. Please always take note of the information that is provided with the product. For more detailed information, please consult with your contact partner or directly with Richard Wolf GmbH.

VERES CANNULAS

FOR CREATION OF THE PNEUMOPERITONEUM

				
		Outer Ø	WL	Product no.
	VERES cannula Ø 2.1 mm WL 150 mm	2.1 mm	150 mm	8302.15
	VERES cannula Ø 2.1 mm WL 152 mm (standard length)		120 mm	8302.12
	VERES cannula Ø 2.1 mm WL 80 mm		80 mm	8302.08
for this:				
Tube with Luer-Lock connector				886.00

Accessories	Product no.
Stopcock insert bndl cap. 3.0 mm (PACK= 5 PCS)	896.0002

11123 || Subject to modifications. Please note that some products may not be available in all countries. Please always take note of the information that is provided with the product. For more detailed information, please consult with your contact partner or directly with Richard Wolf GmbH.

ERAGON^{modular}

THE LAPAROSCOPIC TOOLBOX

The toolbox principle

ERAGONmodular allows the surgeon to create their ideal laparoscopic set. Ergonomic handles, diameters relevant to all medical practice, useful working lengths, and a range of jaw sections can be combined as necessary. This universal compatibility also ensures that individual trays can comprise fewer instruments – for more efficiency and one way of cutting costs

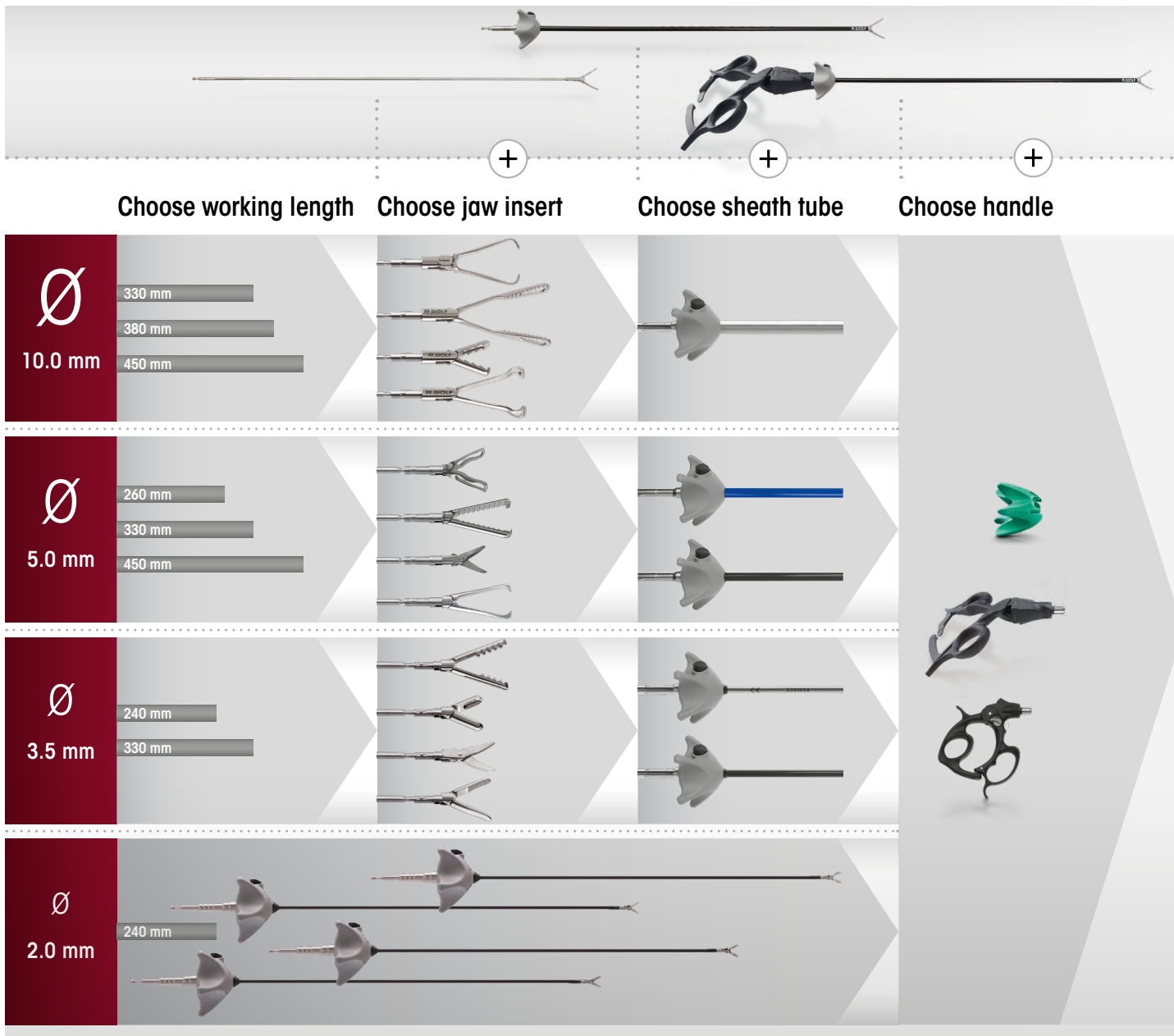

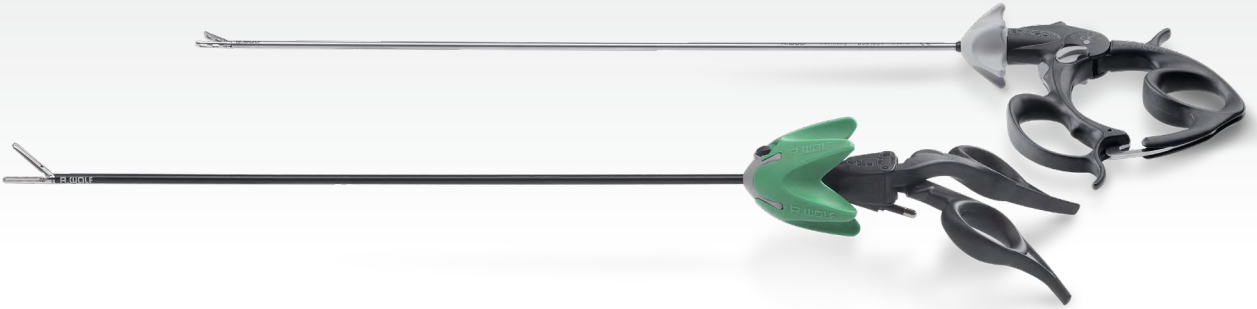



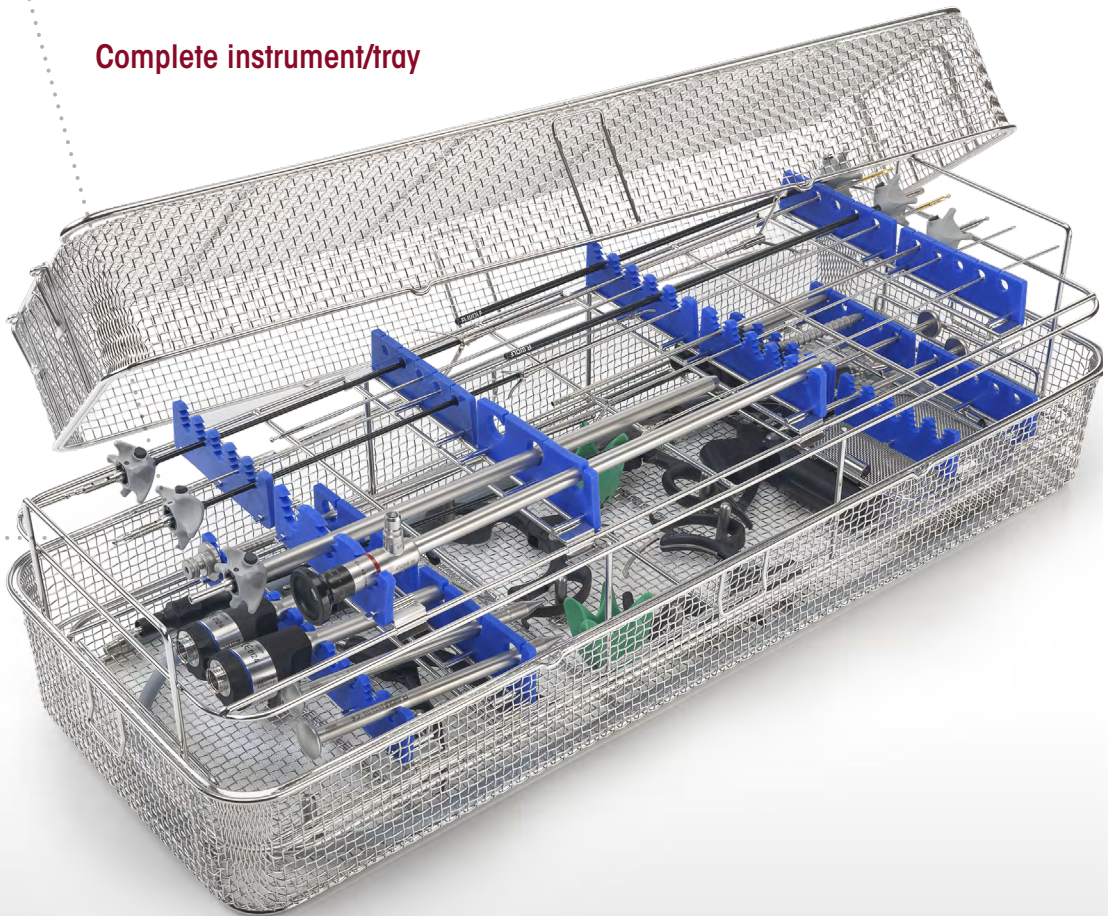





Complete instrument/tray







ERAGON modular
micro
Ø 2 MM, INSULATED

		Handle, axial	
ERAGON axial			
All jaw inserts and sheath tubes can also be combined with ERAGON axial		without lock, with HF connector	without lock, with HF connector
Rotatable knob	Product no.	83930083	83930084
	8988	•	•

Jaw insert			Sheath tube, Ø 2.0 mm, insulated	Handle, pistol-shaped	Complete instrument • Jaw insert with sheath tube • Handle
					
			WL 240 mm	without lock, with HF, mono	
	JL*	Product no.		83930073	Product no.
	7 mm	8388200	•	•	83882007
straight, double-action					
	7 mm	8388201	•	•	83882017
straight, double-action					
	7 mm	8388202	•	•	83882027
fenestrated, double-action					

* JL = jaw length when jaw section closed (approximate measurements)
HF connection cable: see sheet BDE116/117

ERAGON modular
micro
Ø 2 MM, INSULATED

Jaw insert		Sheath tube, Ø 2.0 mm, insulated		Handle, pistol-shaped	Complete instrument • Jaw insert with sheath tube • Handle
					
		WL 240 mm		with lock, with HF, mono	
	JL*	Product no.		83930074	Product no.
 Grasping forceps mono Ø 2 mm bndl double-action	7 mm	8388203	•	•	83882037

* JL = jaw length when jaw section closed (approximate measurements)
HF connection cable: see sheet BDE116/117



Accessories for manual and machine reprocessing		Product no.
	Irrigation adapter Ø 9 mm, length 64 mm	163502







ERAGON modular mini

Ø 3.5 MM, INSULATED

ERAGONMODULAR

4

		Handle, axial	
ERAGON axial			
All jaw inserts and sheath tubes can also be combined with ERAGON axial		without lock, with HF connector	without lock, with HF connector
Rotatable knob	Product no.	83930083	83930084
	8988	•	•









Jaw insert		Sheath tube, Ø 3.5 mm, insulated		Handle, pistol-shaped	Complete instrument
					<ul style="list-style-type: none"> • Jaw insert with sheath tube • Handle
JL*		WL 240 mm	WL 330 mm	with lock, with HF, mono	
	Product no.	8390933	8391933	83930074	Product no.
	15 mm	8390207	•	•	83902077
curved to the left, double-action		8391207	•	•	83912077
	18 mm	8390221	•	•	83902217
long, fine tip, double-action		8391221	•	•	83912217
	14 mm	8390222	•	•	83902227
short, fine tip, double-action		8391222	•	•	83912227
	14 mm	8390223	•	•	83902237
angled, double-action		8391223	•	•	83912237

* JL = jaw length when jaw section closed (approximate measurements)

HF connection cable: see sheet BDE116/117

ERAGON modular
mini

Ø 3.5 MM, INSULATED





Jaw insert			Sheath tube, Ø 3.5 mm, insulated		Handle, pistol-shaped		Complete instrument • Jaw insert with sheath tube • Handle
							
							WL 240 mm
	JL*	Product no.	8390933	8391933	83930073	83930074	Product no.
 Metzenbaum scissors mono Ø 3.5 mm bndl 16 mm double-action		8390215	•		•		83902157
		8391215			•		83912157
 Metzenbaum scissors mono Ø 3.5 mm bndl 14 mm fine-toothed, curved, double-action		8390224	•		•		83902247
		8391224			•		83912247
 Hook scissors mono Ø 3.5 mm bndl 8 mm single-action		8390227	•		•		83902277
		8391227			•		83912277
 Double spoon forceps mono Ø 3.5 mm bndl 12 mm		8390216	•			•	83902167
		8391216			•		•
 Friedel punch mono Ø 3.5 mm bndl 10 mm		8390217	•			•	83902177
		8391217			•		•







* JL = jaw length when jaw section closed (approximate measurements)

HF connection cable: see sheet BDE116/117

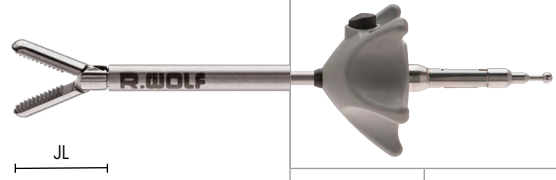
Accessories for manual and machine reprocessing		Product no.
	Irrigation adapter Ø 9 mm, length 64 mm	163502

ERAGON modular mini
Ø 3.5 MM, UNINSULATED

		Handle, axial	
 All jaw inserts and sheath tubes can also be combined with ERAGONaxial			
		with lock, without HF connector	with lock, without HF connector, not rotatable
Rotatable knob	Product no.	83930082	83930085
	8988	.	.







Jaw insert			Sheath tube, Ø 3.5 mm, uninsulated		Handle, pistol-shaped	Complete instrument
 JL			WL 240 mm	WL 330 mm	 with lock, without HF	• Jaw insert with sheath tube • Handle
			Product no.	8390933		8391933
 14 mm fenestrated, double-action	JL*	8390208	.	.	.	83902087
		8391208	.	.	.	83912087
 17 mm fenestrated, single-action	JL*	8390218	.	.	.	83902187
		8391218	.	.	.	83912187
 17 mm double fenestrated, curved, single-action	JL*	8390225	.	.	.	83902257
		8391225	.	.	.	83912257
 19 mm fenestrated, double-action	JL*	8390226	.	.	.	83902267
		8391226	.	.	.	83912267

* JL = jaw length when jaw section closed (approximate measurements)

HF connection cable: see sheet BDE116/117

III23 || Subject to modifications. Please note that some products may not be available in all countries. Please always take note of the information that is provided with the product. For more detailed information, please consult with your contact partner or directly with Richard Wolf GmbH.

ERAGON modular mini
Ø 3.5 MM, UNINSULATED

Jaw insert			Sheath tube, Ø 3.5 mm, uninsulated		Handle, pistol-shaped	Complete instrument • Jaw insert with sheath tube • Handle
			WL 240 mm	WL 330 mm	 with lock, without HF	
			Product no.	8390933		8391933
 fenestrated, double-action	13 mm	8390219	•		•	83902197
		8391219		•	•	83912197
 fenestrated, single-action	17 mm	8390220	•		•	83902207
		8391220		•	•	83912207
 double-action	14 mm	8390209	•		•	83902097
		8391209		•	•	83912097
 double-action	19 mm	8390210	•		•	83902107
		8391210		•	•	83912107

* JL = jaw length when jaw section closed (approximate measurements)
HF connection cable: see sheet BDE116/117







Accessories for manual and machine reprocessing		Product no.
	Irrigation adapter Ø 9 mm, length 64 mm	163503







11123 || Subject to modifications. Please note that some products may not be available in all countries. Please always take note of the information that is provided with the product. For more detailed information, please consult with your contact partner or directly with Richard Wolf GmbH.

ERAGON modular
Ø 5.0 MM, INSULATED

ERAGONMODULAR

4

		Handle, axial			
 All jaw inserts and sheath tubes can also be combined with ERAGONaxial					
		with lock	without lock, with HF connector	without lock, with HF connector	with lock, not rotatable
Rotatable knob	Product no.	83930082	83930083	83930084	83930085
	8988	•	•	•	







Jaw insert		Sheath tube, Ø 5.0 mm, insulated		Handle, pistol-shaped	Complete instrument
					<ul style="list-style-type: none"> • Jaw insert with sheath tube • Handle
	JL*	SL 330 mm	SL 450 mm	with lock, with HF, mono	Product no.
	Product no.	8393933	8394933	83930074	
	21 mm	•		•	83932817
Maryland dissector forceps mono Ø 5 mm bndl curved, with fine cross tothing, double-action		8393.281			
		8394.281	•	•	83942817
	22 mm	•		•	83932837
Mixer dissector forceps mono Ø 5 mm bndl angled, fine, pyramid-shaped tothing, double-action		8393.283			
	21 mm	•		•	83931857
Grasping forceps, mono Ø 5 mm bndl fenestrated, with fine cross tothing, 15 mm long, single-action		8393.185			
	26 mm	•		•	83931847
Grasping forceps, mono Ø 5 mm bndl fenestrated, with fine cross tothing, 20 mm long, single-action		8393.184			
		8394.184	•	•	83941847

* JL = jaw length when jaw section closed (approximate measurements)
HF connection cable: see sheet BDE116/117

III23 || Subject to modifications. Please note that some products may not be available in all countries. Please always take note of the information that is provided with the product. For more detailed information, please consult with your contact partner or directly with Richard Wolf GmbH.

ERAGON modular

Ø 5.0 MM, INSULATED

Jaw insert			Sheath tube, Ø 5.0 mm, insulated			Handle, pistol-shaped			Complete instrument • Jaw insert with sheath tube • Handle
			SL 260 mm	SL 330 mm	SL 450 mm	with lock, without HF	without lock, with HF, mono	with lock, with HF, mono	
	JL*	Product no.	8392933	8393933	8394933	83930072	83930073	83930074	Product no.
 Dolphin dissector forceps mono Ø 5 mm bndl angled, with fine cross-toothing, with channel, narrow, 15 mm long, double-action	17 mm	8393.285		•			•		83932857
 Dissector forceps mono Ø 5 mm bndl fine pyramid-shaped toothing, narrow, 18 mm, double-action	23 mm	8393.289		•				•	83932897
 Atraumatic grasping forceps Ø 5 mm bndl Channel with wavy tooth edge, 20 mm, single-action	26 mm	8393.292		•			•		83932925
 Atraumatic grasping forceps Ø 5 mm bndl Channel with wavy tooth edge, 20 mm, double-action	26 mm	8393.293		•			•		83932935
		8394.293			•		•		83942935
 Grasping forceps, mono Ø 5 mm bndl fine, pyramid-shaped toothing, narrow double-action	19 mm	8393.288		•				•	83932887
 Atraumatic grasping forceps mono Ø 5 mm bndl fenestrated, with cross toothing, double-action	19 mm	8392.181	•					•	83921817
		8393.181		•				•	83931817
		8394.181			•			•	83941817







* JL = jaw length when jaw section closed (approximate measurements)







HF connection cable: see sheet BDE116/117

ERAGON modular
Ø 5.0 MM, INSULATED

ERAGONMODULAR

4

		Handle, axial			
 All jaw inserts and sheath tubes can also be combined with ERAGONaxial					
		with lock	without lock, with HF connector	without lock, with HF connector	with lock, not rotatable
Rotatable knob	Product no.	83930082	83930083	83930084	83930085
	8988	•	•	•	









Jaw insert		Sheath tube, Ø 5.0 mm, insulated		Handle, pistol-shaped		Complete instrument • Jaw insert with sheath tube • Handle	
							
	JL*	Product no.	SL 330 mm	SL 450 mm	with lock, without HF	without lock, with HF, mono	Product no.
 Atraumatic grasping forceps mono Ø 5 mm bndl 18 mm smooth, double-action	18 mm	8393.195	•			•	83931957
		8394.195		•			•
 Babcock forceps Ø 5 mm bndl 24 mm Gripping surface with fine cross tothing, double-action	24 mm	8393.186	•			•	83931867
		8393.187	•				•
 Babcock forceps Ø 5 mm bndl 26 mm large distal gripping surface with fine cross tothing, double-action	26 mm	8393.187	•			•	83931877
		8394.187		•			•
 Debakey forceps Ø 5 mm bndl 39 mm atraumatic clamp, double-action	39 mm	8393190	•			•	83931907

* JL = jaw length when jaw section closed (approximate measurements)

HF connection cable: see sheet BDE50 1710

III23 || Subject to modifications. Please note that some products may not be available in all countries. Please always take note of the information that is provided with the product. For more detailed information, please consult with your contact partner or directly with Richard Wolf GmbH.







ERAGON modular
Ø 5.0 MM, INSULATED









Jaw insert			Sheath tube, Ø 5.0 mm, insulated		Handle, pistol-shaped		Complete instrument • Jaw insert with sheath tube • Handle
							
			SL 330 mm	SL 450 mm	with lock, without HF	with lock, with HF, mono	
	JL*	Product no.	8393933	8394933	83930072	83930074	Product no.
 Debaque forceps Ø 5 mm bndl atraumatic clamp, double-action	48 mm	8393191	•		•		83931917
 Grasping forceps, mono Ø 5 mm bndl with a row of teeth, double-action	17 mm	8393.485	•			•	83934857
 Grasping forceps, mono Ø 5 mm bndl with one tooth, fine cross toothing, narrow, double-action	19 mm	8393.486	•			•	83934867
 Grasping forceps, mono Ø 5 mm bndl with two teeth, fine cross toothing, single-action	17 mm	8393.487	•			•	83934877
 Grasping forceps Ø 5 mm bndl with two teeth wavy gripping surface, double-action		8393.490	•		•		83934907
	26 mm	8394.490		•	•		83944907
 Petelin dissector forceps mono Ø 5 mm bndl angled 30° to the left, with cross toothing, single-action	17 mm	8393.282	•			•	83932827

* JL = jaw length when jaw section closed (approximate measurements)

HF connection cable: see sheet BDE116/117

ERAGON modular
Ø 5.0 MM, INSULATED

		Handle, axial			
 All jaw inserts and sheath tubes can also be combined with ERAGONaxial					
		with lock	without lock, with HF connector	without lock, with HF connector	with lock, not rotatable
Rotatable knob	Product no.	83930082	83930083	83930084	83930085
	8988	•	•	•	







Jaw insert		Sheath tube, Ø 5.0 mm, insulated	Handle, pistol-shaped			Complete instrument	
		 SL 330 mm				• Jaw insert with sheath tube • Handle	
	JL*	Product no.	8393933	83930072	83930073	83930074	Product no.
 Plate-shaped grasping forceps mono Ø 5 mm bndl fenestrated with fine cross tothing, double-action	18 mm	8393.182	•			•	83931827
 Grasping forceps mono Ø 5 mm bndl with cross tothing, double-action	21 mm	8393.183	•		•		83931837
 Grasping forceps mono Ø 5 mm bndl distal cross tothing with channel, double-action	15 mm	8393.287	•		•		83932877
 Claw grasping forceps Ø 5 mm bndl double-action	27 mm	8393.494	•	•			83934945

* JL = jaw length when jaw section closed (approximate measurements)

HF connection cable: see sheet BDE116/117

ERAGON modular

Ø 5.0 MM, INSULATED

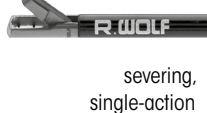
Jaw insert			Sheath tube, Ø 5.0 mm, insulated		Handle, pistol-shaped			Complete instrument • Jaw insert with sheath tube • Handle
			SL 330 mm	SL 450 mm	with lock, without HF	without lock, with HF, mono	with lock, with HF, mono	
	JL*	Product no.	8393933	8394933	83930072	83930073	83930074	Product no.
Myoma grasping forceps Ø 5 mm bndl  2x3-claw, single-action	29 mm	8393.488	•		•			83934887
Universal grasping forceps mono Ø 5 mm bndl  with pyramid-shaped toothing and cross toothing, double-action	18 mm	8393.481	•				•	83934817
Universal grasping forceps Ø 5 mm bndl  pyramid-shaped toothing and cross toothing, double-action	26 mm	8393.482	•		•			83934827
Grasping forceps mono Ø 5 mm bndl  Pike-mouth, double-action	20 mm	8393.483	•				•	83934837
Biopsy forceps mono Ø 5 mm bndl  with spikes, double-action	13 mm	8393.091	•				•	83930917
		8394.091		•		•		83940917
Biopsy forceps mono Ø 5 mm bndl  severing, single-action	14 mm	8393.092	•				•	83930927
		8394.092		•		•		83940927







* JL = jaw length when jaw section closed (approximate measurements)









HF connection cable: see sheet BDE116/117

ERAGON modular
Ø 5.0 MM, INSULATED

ERAGONMODULAR

4

		Handle, axial			
 All jaw inserts and sheath tubes can also be combined with ERAGONaxial					
		with lock	without lock, with HF connector	without lock, with HF connector	with lock, not rotatable
Rotatable knob	Product no.	83930082	83930083	83930084	83930085
	8988	•	•	•	







Jaw insert			Sheath tube, Ø 5.0 mm, insulated		Handle, pistol-shaped		Complete instrument • Jaw insert with sheath tube • Handle
							
	JL*	Product no.	SL 330 mm	SL 450 mm	with lock, without HF	without lock, with HF, mono	Product no.
	20 mm	8393.093	•			•	83930937
 with distal recess, double-action	17 mm	8393.345	•		•		83933457
		8394.345		•			83943457
 spring jaw sections fenestrated with cross tothing, double-action	37 mm	8393.188	•		•		83931887
 spring jaw sections fenestrated with cross tothing, double-action	47 mm	8393.189	•		•		83931897
		8394.189		•			83941897

* JL = jaw length when jaw section closed (approximate measurements)
 HF connection cable: see sheet BDE116/117

III23 || Subject to modifications. Please note that some products may not be available in all countries. Please always take note of the information that is provided with the product. For more detailed information, please consult with your contact partner or directly with Richard Wolf GmbH.

ERAGON modular

Ø 5.0 MM, INSULATED

Jaw insert			Sheath tube, Ø 5.0 mm, insulated		Handle, pistol-shaped		Complete instrument • Jaw insert with sheath tube • Handle
			SL 330 mm	SL450 mm	with lock, without HF	with lock, with HF, mono	
	JL*	Product no.	8393933	8394933	83930072	83930074	Product no.
 Debaquey forceps Ø 5 mm bndl atraumatic, spring jaw sections with cross toothings, double-action	47 mm	8393.291	•		•		83932917
 Dissector forceps mono Ø 5 mm bndl angled, double-action	18 mm	8393192	•			•	83931927
		8394192		•		•	83941927
 Grasping forceps, mono Ø 5 mm bndl double-action	16 mm	8393193	•		•		83931937
		8394193		•	•		83941937
 Dissector forceps mono Ø 5 mm bndl double-action	24 mm	8393194	•			•	83931947
		8394194		•		•	83941947
 Dissector forceps mono Ø 5 mm bndl double-action	30 mm	8393197	•			•	83931977
		8394197		•		•	83941977
 Dissector forceps mono Ø 5 mm bndl fine tips double-action	33 mm	8393198	•			•	83931987
		8394198		•		•	83941987







* JL = jaw length when jaw section closed (approximate measurements)







HF connection cable: see sheet BDE116/117

ERAGON modular
Ø 5.0 MM, INSULATED

ERAGONMODULAR

4

		Handle, axial			
 All jaw inserts and sheath tubes can also be combined with ERAGONaxial					
		with lock	without lock, with HF connector	without lock, with HF connector	with lock, not rotatable
Rotatable knob	Product no.	83930082	83930083	83930084	83930085
	8988	•	•	•	









Jaw insert		Sheath tube, Ø 5.0 mm, insulated		Handle, pistol-shaped	Complete instrument
					• Jaw insert with sheath tube • Handle
	JL*	SL 330 mm	SL 450 mm	with lock, with HF, mono	Product no.
 Dissector forceps mono Ø 5 mm bndl 32 mm double-action		8393933	8394933	83930074	83931997
		8393199	•	•	•
 Dissector forceps mono Ø 5 mm bndl 19 mm fine tip, double-action		8393200			83932007
		8394200	•	•	•
 Atraumatic grasping forceps mono Ø 5 mm bndl 16 mm atraumatic, with cross toothing, double-action		8393210			83932107
		8393210	•	•	•
 Atraumatic grasping forceps mono Ø 5 mm bndl 19mm atraumatic, with cross toothing, double-action		8393220			83932207
		8394220	•	•	•

* JL = jaw length when jaw section closed (approximate measurements)

HF connection cable: see sheet BDE116/117

11123 || Subject to modifications. Please note that some products may not be available in all countries. Please always take note of the information that is provided with the product. For more detailed information, please consult with your contact partner or directly with Richard Wolf GmbH.

ERAGON modular
Ø 5.0 MM, INSULATED

Jaw insert			Sheath tube, Ø 5.0 mm, insulated		Handle, pistol-shaped		Complete instrument • Jaw insert with sheath tube • Handle
							
			SL 330 mm	SL 450 mm	with lock, without HF	with lock, with HF, mono	
	JL*	Product no.:	8393933	8394933	83930072	83930074	Product no.:
 Atraumatic grasping forceps Ø 5 mm bndl atraumatic, with pyramid-shaped toothings and cross toothings, double-action	29 mm	8393223	•		•		83932237
		8394223		•	•		83942237
 Atraumatic grasping forceps Ø 5 mm bndl atraumatic, single fenestrated with cross toothings, double-action	25 mm	8393250	•		•		83932507
		8394250		•	•		83942507
 Atraumatic grasping forceps Ø 5 mm bndl atraumatic, double fenestrated and curved single-action	32 mm	8393229	•		•		83932297
		8394229		•	•		83942297
 Grasping forceps Ø 5 mm bndl atraumatic, narrow and rounded, double-action	15 mm	8393230	•		•		83932307
		8394230		•	•		83942307
 Dissector forceps mono Ø 5 mm bndl curved, double-action	19 mm	8393240	•			•	83932407
		8394240		•		•	83942407
 Dissector forceps mono Ø 5 mm bndl single fenestrated double-action	17 mm	8393242	•		•		83932427
		8394242		•	•		83942427







* JL = jaw length when jaw section closed (approximate measurements)
HF connection cable: see sheet BDE116/117







11123 || Subject to modifications. Please note that some products may not be available in all countries. Please always take note of the information that is provided with the product. For more detailed information, please consult with your contact partner or directly with Richard Wolf GmbH.

ERAGON modular
Ø 5.0 MM, INSULATED

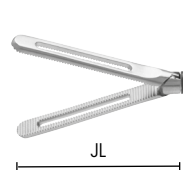
ERAGONMODULAR





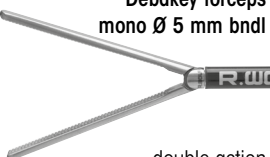



4

		Handle, axial			
 All jaw inserts and sheath tubes can also be combined with ERAGONaxial					
		with lock	without lock, with HF connector	without lock, with HF connector	with lock, not rotatable
Rotatable knob	Product no.	83930082	83930083	83930084	83930085
	8988	•	•	•	

Jaw insert		Sheath tube, Ø 5.0 mm, insulated		Handle, pistol-shaped		Complete instrument • Jaw insert with sheath tube • Handle
						
	JL*	SL 330 mm	SL 450 mm	with lock, without HF	with lock, with HF, mono	Product no.
 Intestine grasping forceps Ø 5 mm bndl atraumatic, single fenestrated with cross toothing, double-action	38 mm	8393249	•	•		83932497
		8394249	•	•		83942497
 Debakey forceps mono Ø 5 mm bndl curved, double-action	35 mm	8393256	•		•	83932567
	 Debakey forceps mono Ø 5 mm bndl double-action	47 mm	8393258	•		•
		8394258	•	•		83942587

* JL = jaw length when jaw section closed (approximate measurements)
 HF connection cable: see sheet BDE116/117

ERAGON modular
Ø 5.0 MM, INSULATED

Jaw insert			Sheath tube, Ø 5.0 mm, insulated		Handle, pistol-shaped	Complete instrument • Jaw insert with sheath tube • Handle
						
			SL 330 mm	SL 450 mm	without lock, with HF, mono	
	JL*	Product no.	8393933	8394933	83930073	Product no.
 23 mm		8393.041	•		•	83930417
	curved, double-action	8394.041		•	•	83940417
 18 mm		8393.044	•		•	83930447
curved, double-action						
 20 mm		8393.045	•		•	83930457
narrow, straight, double-action						
 14 mm		8393.081	•		•	83930817
	serrated, single-action	8394.081		•	•	83940817
 21 mm		8393243	•		•	83932437
	double-action	8394243		•	•	83942437
 26 mm		8393246	•		•	83932467
	curved and toothed double-action	8394246		•	•	83942467







* JL = jaw length when jaw section closed (approximate measurements)







HF connection cable: see sheet BDE116/117

ERAGON^{modular}
 Ø 5.0 MM, INSULATED

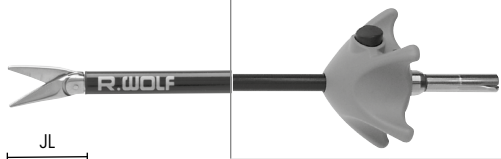
ERAGONMODULAR

4

		Handle, axial			
 All jaw inserts and sheath tubes can also be combined with ERAGONaxial					
		with lock	without lock, with HF connector	without lock, with HF connector	with lock, not rotatable
Rotatable knob	Product no.	83930082	83930083	83930084	83930085
	8988	•	•	•	

Jaw insert		Sheath tube, Ø 5.0 mm, insulated		Handle, pistol-shaped		Complete instrument	
 JL						• Jaw insert with sheath tube • Handle	
		SL 330 mm	SL 450 mm	with lock, without HF	without lock, with HF, mono		
	JL*	Product no.	8393933	8394933	83930072	83930073	Product no.
 Scissors mono Ø 5 mm bndl 22 mm	22 mm	8393248	•			•	83932487
		8394248		•		•	83942487
 Knot pusher Ø 5 mm bndl 17 mm	17 mm	8393.345	•			•	83933457
		8394345		•		•	83943457
 Gastric band manipulator Ø 5 mm bndl 47 mm	47 mm	8393253	•			•	83932537
		8394253		•		•	83942537



* JL = jaw length when jaw section closed (approximate measurements)

HF connection cable: see sheet BDE116/117

Accessories for manual and machine reprocessing		Product no.
	Irrigation adapter Ø 9 mm, length 64 mm	163502

III23 | Subject to modifications. Please note that some products may not be available in all countries. Please always take note of the information that is provided with the product. For more detailed information, please consult with your contact partner or directly with Richard Wolf GmbH.

ERAGON^{modu} blades
 Ø 5.0 MM, INSULATED

 All jaw inserts and sheath tubes can also be combined with ERAGONaxial		 without lock, with HF connector		
		Rotatable knob	Product no.	83930083
		8988	•	

Scissors attachment		Tension rod Ø 5.0 mm			Sheath tube insulated Ø 5.0 mm			Handle pistol-shaped	Complete instrument • Jaw insert with sheath tube • Handle
									
		for SL 260 mm	for SL 330 mm	for SL 450 mm	SL 240 mm	SL 310 mm	SL 430 mm	without lock, rotatable with HF connector	
	Product no.	8392934	8393934	8394934	8392935	8393935	8394935	83930073	Product no.
Metzenbaum scissors attachment mono 		•			•			•	83920407
4393040 (PACK= 10 PCS), sterile, disposable			•			•		•	83930407
				•			•	•	83940407







HF connection cable: see sheet BDE116/117







11123 || Subject to modifications. Please note that some products may not be available in all countries. Please always take note of the information that is provided with the product. For more detailed information, please consult with your contact partner or directly with Richard Wolf GmbH.

ERAGON modular
Ø 10 MM, UNINSULATED

ERAGONMODULAR

4







		Handle, axial	
 All jaw inserts and sheath tubes can also be combined with ERAGONaxial			
		with lock, without HF connector	with lock, without HF connector, not rotatable
Rotatable knob	Product no.	83930082	83930085
	8988	.	.

Jaw insert		Sheath tube, Ø 10.0 mm, uninsulated		Handle, pistol-shaped	Complete instrument	
					<ul style="list-style-type: none"> Jaw insert with sheath tube Handle 	
		SL 327 mm	SL 447 mm	with lock, without HF		
	JL*	Product no.	8395902	8396902	83930072	Product no.
 Maryland dissector forceps Ø 10 mm bndl	36 mm	8395.225	.	.	.	83952257
		8396225	.	.	.	83962257
 Dissector forceps Ø 10 mm bndl	35 mm	8395.226	.	.	.	83952268
		8396226	.	.	.	83962267
 Grasping forceps Ø 10 mm bndl	20 mm	8395.236	.	.	.	83952368
		8396236	.	.	.	83962367
 Grasping forceps Ø 10 mm bndl	49 mm	8395.204	.	.	.	83952048
		8396204	.	.	.	83962047

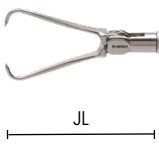
* JL = jaw length when jaw section closed (approximate measurements)
 HF connection cable: see sheet BDE116/117

||| Subject to modifications. Please note that some products may not be available in all countries. Please always take note of the information that is provided with the product. For more detailed information, please consult with your contact partner or directly with Richard Wolf GmbH.

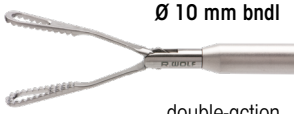



ERAGON modular
Ø 10 MM, UNINSULATED



Jaw insert			Sheath tube, Ø 10.0 mm, uninsulated			Handle, pistol-shaped		Complete instrument • Jaw insert with sheath tube • Handle
			SL 327 mm	SL 447 mm	SL 387 mm	with lock, without HF		
	JL*	Product no.	8395902	8396902	8397902	83930072	83930082	Product no.
 Claw grasping forceps Ø 10 mm bndl double-action	38 mm	8395.489	•			•		83954897
 Claw grasping forceps Ø 10 mm bndl with additional row of teeth, double-action	38 mm	8395490	•			•		83954907
 Babcock forceps Ø 10 mm bndl large distal gripping surface with fine cross toothing, double-action	42 mm	8395.187	•			•		83951877
		8396187		•		•		83961877
 Babcock forceps Ø 10 mm bndl double-action	38 mm	8395.214	•			•		83952148
 Plate-shaped grasping forceps Ø 10 mm bndl double-action	50 mm	8395.234	•			•		83952347
		8396234		•		•		83962347
 Spoon forceps Ø 10 mm bndl single-action	31 mm	8395.244	•			•		83952448
 Stapler head grasping forceps Ø 10 mm bndl angled 30°, double-action		8397.655			•		•	83976558



* JL = jaw length when jaw section closed (approximate measurements)/HF connection cable: see sheet BDE116/117

11123 || Subject to modifications. Please note that some products may not be available in all countries. Please always take note of the information that is provided with the product. For more detailed information, please consult with your contact partner or directly with Richard Wolf GmbH.

ERAGON modular
ACCESSORIES

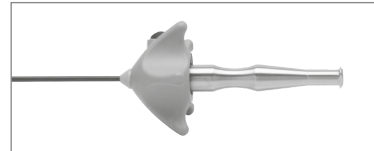
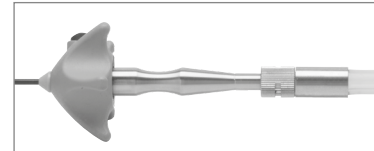
For insulated sheath tubes		Product no.
	For manual and machine reprocessing: Irrigation adapter Ø 9 mm, length 64 mm for insulated sheath tubes	163502
		





For uninsulated sheath tubes		Product no.
	For manual and machine reprocessing: Irrigation adapter cleaning Ø 9 mm, length 64 mm for uninsulated sheath tubes	163503
		





	8393932
	8394932



		Ø	SL	Product no.
	Sheath tube insulated Ø 5 mm SL 330 mm with distal cm scale	5 mm	330 mm	8393932
	Sheath tube insulated Ø 5 mm SL 450 mm with distal cm scale	5 mm	450 mm	8394932

III23 || Subject to modifications. Please note that some products may not be available in all countries. Please always take note of the information that is provided with the product. For more detailed information, please consult with your contact partner or directly with Richard Wolf GmbH.

HANDLE VARIANTS FOR MODULAR SYSTEMS

Handle, pistol-shaped 	rotatable	with lock	without lock	with HF	without HF	Product no.
	•	•			•	83930072
	•		•	•		83930073
	•	•		•		83930074

Handle, axial 	rotatable	with lock	without lock	with HF	without HF	Product no.
	•	•			•	83930082
	•		•	•		83930083
	•	•		•		83930084
		•			•	83930085

Optional for 83930082/83930083/83930084:		Product no.
 	Rotatable knob autoclavable	8988

All ERAGON^{modular} components are compatible with ERAGON^{axial}

CHOLANGIOGRAPHY CATHETERGRASPING FORCEPS 5 MM

FORCEPS

5

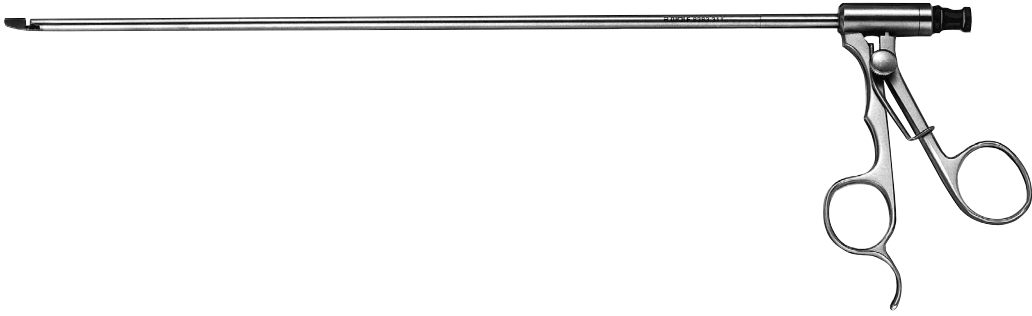







		Outer Ø	WL	Product no.
	Grasping forceps Ø 5 mm WL 295 mm	5.0 mm	295 mm	8383.311

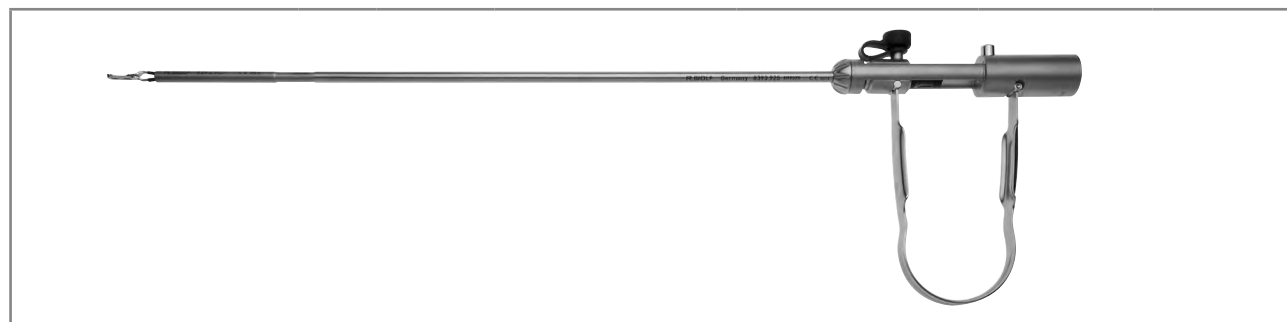

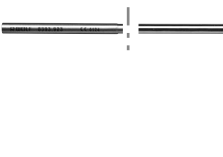

- For inserting a cholangiography catheter up to 7 Fr into the cystic duct

BIPOLAR FORCEPS 3.5 MM/5.0 MM

WITH SPRING HANDLE
MODULAR SYSTEM

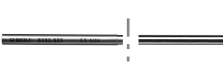

Grasping forceps jaw insert			Outer tube Ø 3.5 mm SL 348 mm	Screw cap with sleeve Ø 5.0 mm SL 107 mm	Spring handle bipo	complete instrument • Jaw insert • Sliding sleeve • Outer tube • Spring handle
						
	JL*	Product no.	8391.921	8393.978	8393.975	Product no.
	39 mm	8391.715	•	•	•	8391.742

Kleppinger grasping forceps jaw insert			Sliding sleeve SL 319 mm	Outer tube Ø 5 mm SL 237 mm	Spring handle bipo	complete instrument • Jaw insert • Sliding sleeve • Outer tube • Spring handle
						
	JL*	Product no.	8393.923	8393.925	8393.975	Product no.
	53 mm	8393.714	•	•	•	8393.741







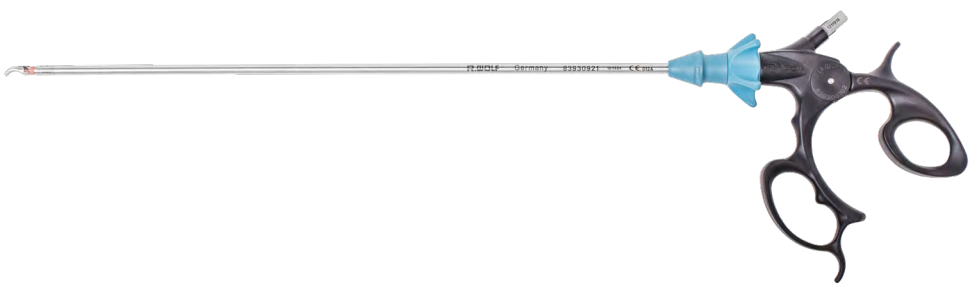

Accessories	Product no.
RIWO rubber cap, jet black	15220.019
Luer sealing cap	15023.153

* JL = jaw length when jaw section closed (approximate measurements)
Bipolar connection cable: see sheet BDE118/119

11123 || Subject to modifications. Please note that some products may not be available in all countries. Please always take note of the information that is provided with the product. For more detailed information, please consult with your contact partner or directly with Richard Wolf GmbH.

ERAGON bipolar
MODULAR BIPOLAR INSTRUMENTS, 5.5 MM
 ROTATABLE







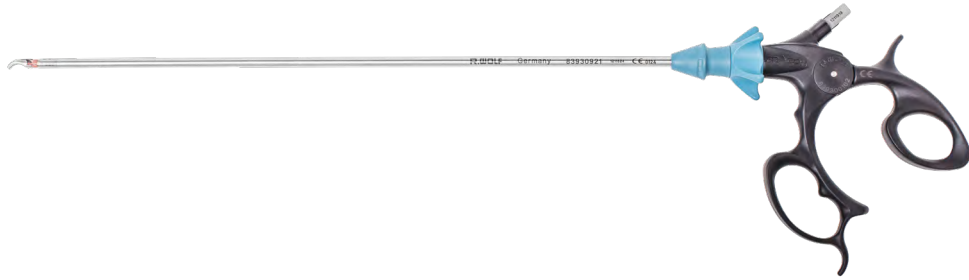

Jaw insert		Sheath tube Ø 5.5 mm		Handle, pistol-shaped, bipo	Complete instrument • Jaw insert • Sheath tube • Handle	
						
		SL 320 mm	SL 435 mm	rotatable		
	JL*	Product no.	83930921	82340024	839300102	Product no.
 Grasping forceps bipo Ø 5.5 mm bndl	21 mm	83930031	•		•	839300312
		839400310			•	839400312
 Maryland dissector bipo Ø 5.5 mm bndl	23 mm	83930032	•		•	839300322
		839400320			•	839400322
 Dolphin dissector bipo Ø 5.5 mm bndl	21 mm	83930033	•		•	839300332
		839400330			•	839400332
 Grasping forceps bipo Ø 5.5 mm bndl	23 mm	83930034	•		•	839300342
		839400340			•	839400342
 Preparation forceps bipo Ø 5.5 mm bndl	19 mm	83930035	•		•	839300352
		839400350			•	839400352

* JL = jaw length when jaw section closed (approximate measurements)
 Bipolar connection cable: see sheet BDE118/119

ERAGON bipolar
MODULAR BIPOLAR INSTRUMENTS, 5.5 MM,
ROTATABLE



Jaw insert			Sheath tube Ø 5.5 mm		Handle, pistol-shaped, bipo	Complete instrument • Jaw insert • Sheath tube • Handle
						
			SL 320 mm	SL 435 mm	rotatable	
	JL*	Product no.	83930921	82340024	839300102	Product no.
	19 mm	83930036	•		•	839300362
	22 mm	83930037	•		•	839300372
		83930038	•		•	839300382
	15 mm	839400380		•	•	839400382
	22 mm	83930041	•		•	839300412
		839400410		•	•	839400412



* JL = jaw length when jaw section closed (approximate measurements)
Bipolar connection cable: see sheet BDE118/119

11123 || Subject to modifications. Please note that some products may not be available in all countries. Please always take note of the information that is provided with the product. For more detailed information, please consult with your contact partner or directly with Richard Wolf GmbH.





ELECTRODES 2.0 MM/3.5 MM

MONOPOLAR



		Outer Ø	WL	Product no.
	Coagulation electrode mono 5 FR WL 400 mm	1.67 mm	400 mm	823.05
	Coagulation electrode mono 6 FR WL 400 mm	2.0 mm	400 mm	823.06





		Outer Ø	WL	Product no.
	Hook electrode mono Ø 3.5 mm WL 310 mm	3.5 mm	310 mm	8379.452
	Hook electrode mono Ø 3.5 mm WL 240 mm with distally extended insulation	3.5 mm	240 mm	8785.642
	Needle electrode mono Ø 3.5 mm WL 310 mm	3.5 mm	310 mm	8379.482
	Coagulation electrode mono Ø 3.5 mm WL 310 mm	3.5 mm	310 mm	8379.462

HF connection cable: see sheet BDE116/117





ELECTRODES 5.0 MM

MONOPOLAR



		Outer Ø	WL	Product no.
	Coagulation electrode mono Ø 5 mm WL 330 mm	5.0 mm	330 mm	8383.40
	Coagulation electrode mono Ø 5 mm WL 450 mm	5.0 mm	450 mm	8384.40



		Outer Ø	WL	Product no.
	Hook electrode mono Ø 5 mm WL 340 mm	5.0 mm	340 mm	8383.423
	Hook electrode mono Ø 5 mm WL 420 mm		420 mm	8384.423
	Needle electrode mono Ø 5 mm WL 340 mm	5.0 mm	340 mm	8383.426
	Spatula electrode mono Ø 5 mm WL 340 mm	5.0 mm	340 mm	8383.428
	Myoma dissector mono Ø 5 mm WL 340 mm	5.0 mm	340 mm	8383429

HF connection cable: see sheet BDE116/117

MULTIFUNCTIONAL SUCTION IRRIGATION SYSTEM

COMBINATION OPTIONS

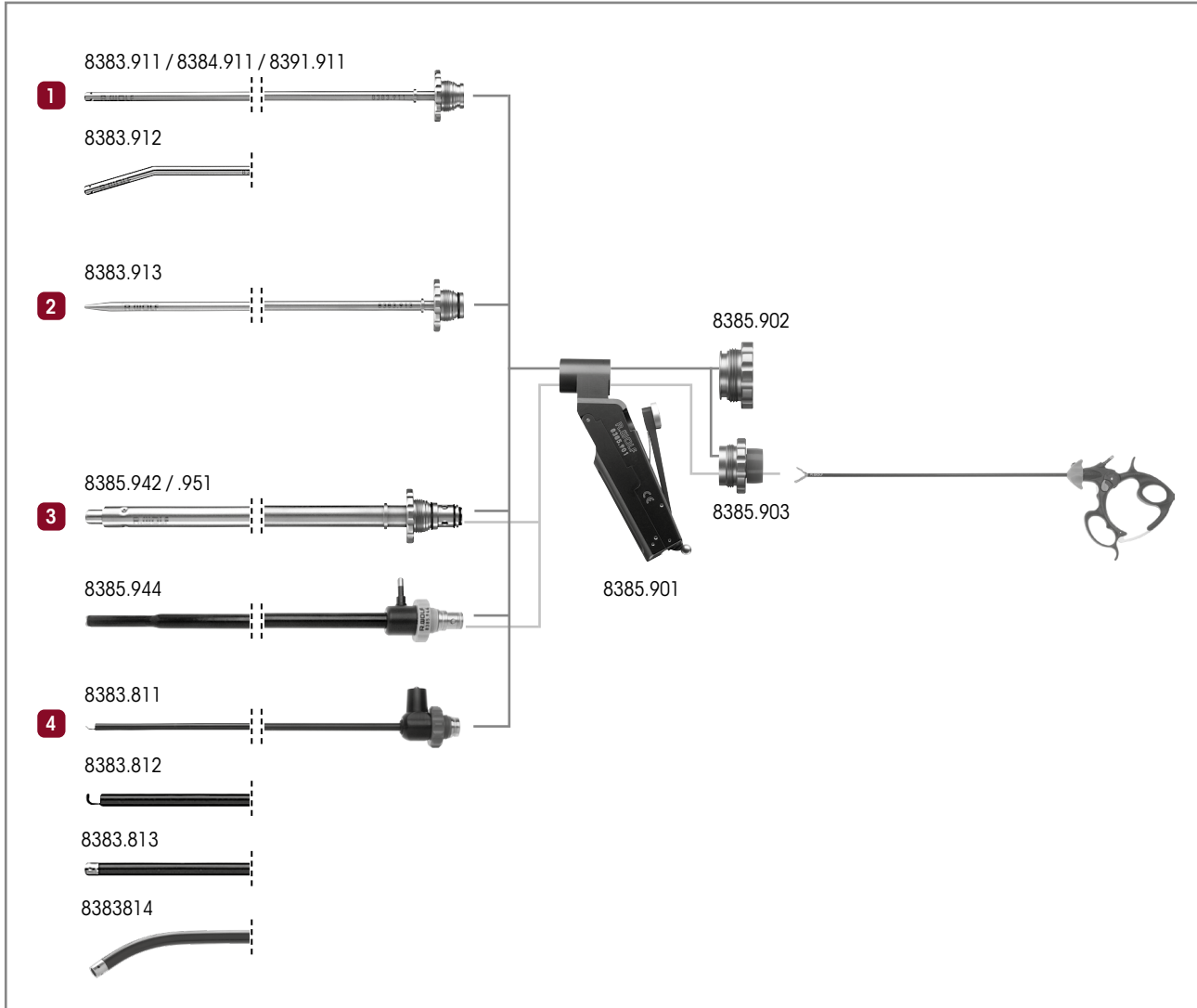

- 1 Suction or irrigation:**
- Suction irrigation tube Ø 5 mm WL 310 mm 8383.911
 - Suction irrigation tube Ø 5 mm WL 450 mm 8384.911
 - Suction irrigation tube Ø 3.5 mm WL 300 mm 8391.911
 - Suction irrigation tube curved Ø 5 mm WL 310 mm... 8383.912
 - for this: **Sealing cap** 8385.902

- 2 Blunt aquadissection:**
- Pressure irrigation tube Ø 5 mm WL 310 mm 8383.913
 - for this: **Sealing cap** 8385.902

- 3 Suction, irrigation, and use of auxiliary instruments Ø 5 mm:**
- Suction irrigation tube Ø 10 mm WL 225 mm 8385.942
 - Suction irrigation tube Ø 10 mm WL 330 mm 8385.951
 - Suction irrigation tube Ø mono 10 mm WL 330 mm, insulated, with atraumatic preparation tip 8385.944
 - for this: **Sealing adapter** 8385.903

- 4 Preparation of tissue with HF:**
- HF suction irrigation tube Ø 5.2 mm WL 317 mm** insulated with integrated HF spatula probe 8383.811
 - HF suction irrigation tube Ø 5.2 mm WL 317 mm** insulated with integrated HF hook electrode 8383.812
 - HF suction irrigation tube Ø 5.2 mm WL 317 mm** insulated with integrated HF button electrode 8383.813
 - HF suction irrigation tube Ø 5.4 mm WL 380 mm** curved with distal openings, insulated with integrated HF button electrode 8383.814
 - for this: **Sealing cap** 8385.902

MULTIFUNCTIONAL SUCTION IRRIGATION SYSTEM

SUCTION IRRIGATION HANDLE

 <p>8385.901</p> <p>AUTOGLAVE 134° C / 273° F</p>	
	Product no.
<p>Suction irrigation handle</p>	8385.901
<p>Sealing cap</p>	8385.902
<p>Required to use auxiliary instruments Ø 5 mm: Sealing attachment with opening and membrane valve</p>	8385.903
<p>Spare Sealing membrane Ø 17 mm yellow, Ø 17 mm, PACK= 10 PCS, for instruments from 3 to 6 mm</p>	89.103

MULTIFUNCTIONAL SUCTION IRRIGATION SYSTEM

SUCTION IRRIGATION TUBE SETS – ILLUSTRATION

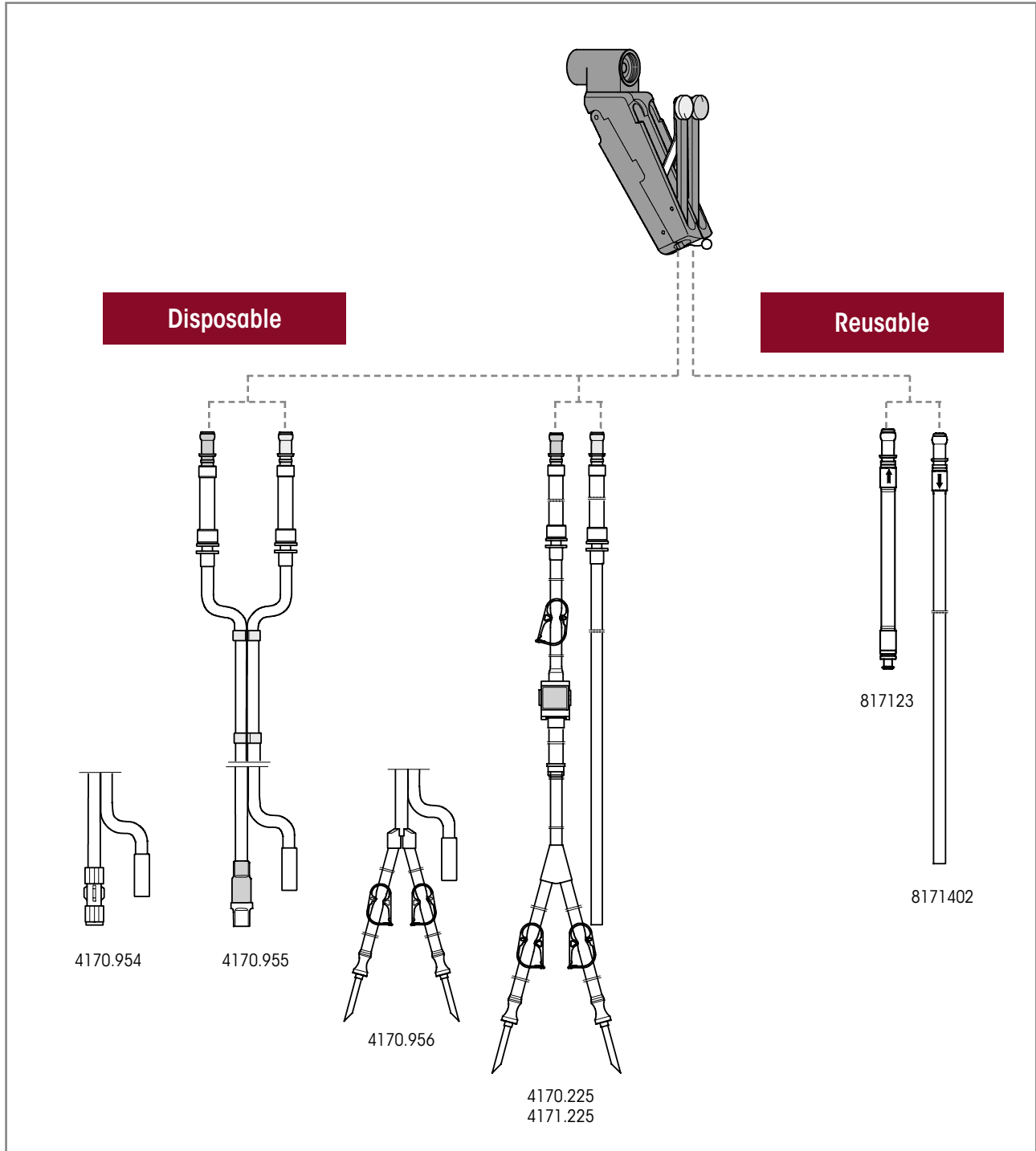

Suction irrigation tube sets are used in conjunction with the suction irrigation handle 8385.901 and pump-side tube systems as well as corresponding collection and secretion containers and/or vacuum pumps (e.g., FLUID CONTROL LAP 2216, LAPARO PUMP 2215)

MULTIFUNCTIONAL SUCTION IRRIGATION SYSTEM

SUCTION IRRIGATION TUBE SETS FOR SUCTION IRRIGATION HANDLE 8385.901







Disposable		Product no.
Suction irrigation tube set, L 3 m (PACK= 10 PCS), sterile	Irrigation tube: With Luer-Lock, for connection to the irrigation tube of a suction irrigation tube set, e.g., irrigation tube of the Endo-Irrigator 2211 Suction tube: For connection to a collection or secretion container and/or vacuum pump	4170.954
Suction irrigation tube set with care-lock, L 3 m (PACK= 10 PCS), sterile	Irrigation tube: With CARE-LOCK, for connection to an irrigation container Suction tube: For connection to a collection or secretion container and/or vacuum pump	4170.955
Suction irrigation tube set with piercing spike, L 3 m (PACK= 10 PCS), sterile	Irrigation tube: With 2 piercing spikes, for connection to an irrigation container Suction tube: For connection to a collection or secretion container and/or vacuum pump	4170.956
Suction irrigation tube set with piercing spike, L 3 m (PACK= 10 PCS), sterile	Irrigation tube: With 2 piercing spikes, for connection to an irrigation container, plus Laparo Pump 2215 and Fluid Control Lap 2216 Suction tube: For connection to a collection or secretion container and/or vacuum pump Also observe instruction manual GA-A 167	4170.225
Suction irrigation tube set, L 3 m (PACK= 10 PCS), sterile	Irrigation tube: With 2 piercing spikes, for connection to an irrigation container, and Fluid Control Lap 2216 Suction tube: For connection to a collection or secretion container and/or vacuum pump Also observe instruction manual GA-A 276	4171.225
Secretion container, 2.5 l	2.5 liters	41706566
Tube set for suction (2 connections)	sterile disposable product (PACK= 10 PCS), for connecting instruments to collecting container	T0503-01
Reusable		Product no.
Irrigation tube L 1.2 m	Irrigation tube: With Luer-Lockconnection for connection to the irrigation tube of a suction irrigation tube set, e.g., 8171223 or 8170.223	817123
Suction tube L 3 m	silicone, for suction irrigation handle 8385.901	8171402
Secretion container, 2 l	2 liters, with lid	8170.655
Secretion container, 2 l	2 liters, no lid	8170.6551

MULTIFUNCTIONAL SUCTION IRRIGATION SYSTEM

SUCTION IRRIGATION TUBES

MULTIFUNCTIONAL SUCTION IRRIGATION SYSTEM

∞





		Outer Ø	WL	Product no.
				
	Suction irrigation tube Ø 3.5 mm WL 300 mm	3.5 mm	300 mm	8391.911
	Suction irrigation tube Ø 5 mm WL 310 mm	5.0 mm	310 mm	8383.911
	Suction irrigation tube Ø 5 mm WL 450 mm	5.0 mm	450 mm	8384.911
	Suction irrigation tube curved Ø 5 mm WL 310 mm	5.0 mm	310 mm	8383.912
	Pressure irrigation tube Ø 5 mm WL 310 mm	5.0 mm	310 mm	8383.913
for use of 5 mm auxiliary instruments				
 capacity 5.0 mm	Suction irrigation tube Ø 10 mm WL 225 mm	10.0 mm	225 mm	8385.942
	Suction irrigation tube Ø 10 mm WL 330 mm	10.0 mm	330 mm	8385.951
 insulated, with atraumatic preparation tip	Suction irrigation tube mono Ø 10 mm WL 330 mm	10.0 mm	330 mm	8385.944
	required for 8385.951: Sealing attachment with opening and membrane valve Sealing membrane Ø 17 mm			8385.903

|||23 || Subject to modifications. Please note that some products may not be available in all countries. Please always take note of the information that is provided with the product. For more detailed information, please consult with your contact partner or directly with Richard Wolf GmbH.

MULTIFUNCTIONAL SUCTION IRRIGATION SYSTEM

SUCTION IRRIGATION TUBES



		Outer Ø	WL	Product no.
 insulated with integrated HF spatula probe	HF suction irrigation tube Ø 5.2 mm WL 317 mm	5.2 mm	317 mm	8383.811
 insulated with integrated HF hook probe	HF suction irrigation tube Ø 5.2 mm WL 317 mm	5.2 mm	317 mm	8383.812
 insulated with integrated HF button electrode	Suction irrigation tube Ø 5 mm WL 450 mm	5 mm	317 mm	8383.813
as alternative to suction irrigation handle:				
	Suction irrigation adapter with maintenance-free two-way stopcock, for multifunctional suction irrigation system			8583819

Accessories	Product no.
HF connection cable	See page BDE116/117







11123 || Subject to modifications. Please note that some products may not be available in all countries. Please always take note of the information that is provided with the product. For more detailed information, please consult with your contact partner or directly with Richard Wolf GmbH.

MULTIFUNCTIONAL SUCTION IRRIGATION SYSTEM

SUCTION IRRIGATION TUBES

MULTIFUNCTIONAL SUCTION IRRIGATION SYSTEM

8

				
		Outer Ø	WL	Product no.
	Suction tube OD 2.8 mm WL 450 mm	2.8 mm	450 mm	8380.68
	Suction irrigation tube Ø 5 mm WL 310 mm	5.0 mm	310 mm	8383.911
	Suction irrigation tube Ø 5 mm WL 450 mm	5.0 mm	450 mm	8384.911
	Suction irrigation tube curved Ø 5 mm WL 310 mm	5.0 mm	310 mm	8383.912
	Pressure irrigation tube Ø 5 mm WL 310 mm	5.0 mm	310 mm	8383.913
for use of 5 mm auxiliary instruments				
 capacity 5.0 mm	Suction irrigation tube Ø 10 mm WL 225 mm	10.0 mm	225 mm	8385.942
	Suction irrigation tube Ø 10 mm WL 330 mm	10.0 mm	330 mm	8385.951
 insulated, with atraumatic preparation tip	Suction irrigation tube mono Ø 10 mm WL 330 mm	10.0 mm	330 mm	8385.944
	required for 8385.951: Sealing attachment with opening and membrane valve, sealing membrane Ø 17 mm			8385.903

III23 || Subject to modifications. Please note that some products may not be available in all countries. Please always take note of the information that is provided with the product. For more detailed information, please consult with your contact partner or directly with Richard Wolf GmbH.

ACCESSORIES FOR SUCTION AND IRRIGATION

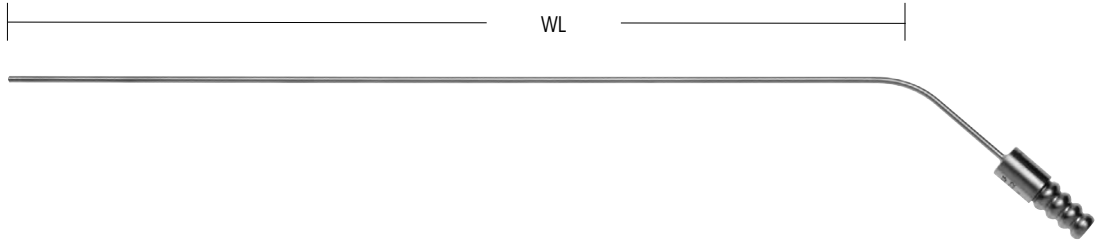

		Outer Ø	WL	Product no.
 central, lateral openings, rigid	suction tube OD 2 mm WL 250 mm	2.0 mm	250 mm	8291.22
	suction tube OD 2.5 mm WL 250 mm	2.5 mm	250 mm	8291.23
	suction tube OD 3 mm WL 250 mm	3.0 mm	250 mm	8291.24
	suction tube OD 4 mm WL 500 mm	4.0 mm	500 mm	8291.45





		Outer Ø	WL	Product no.
	Suction tube OD 2.8 mm WL 450 mm	2.8 mm	450 mm	8380.68

11123 || Subject to modifications. Please note that some products may not be available in all countries. Please always take note of the information that is provided with the product. For more detailed information, please consult with your contact partner or directly with Richard Wolf GmbH.

ACCESSORIES
FOR SUCTION AND IRRIGATION

MULTIFUNCTIONAL SUCTION IRRIGATION SYSTEM



		Outer Ø	WL	Product no.
	Suction tube graduated Ø 5 mm WL 330 mm	5.0 mm	330 mm	8383.68
graduated, with 3 mm Luer connector				



		Outer Ø	WL	Product no.
	Suction irrigation tube Ø 5 mm WL 300 mm	5.0 mm	300 mm	8383.94
with stop valve				





		Outer Ø	WL	Product no.
	Suction irrigation tube WL 290 mm	5.0 mm	290 mm	8583732
with maintenance-free two-way stopcock, sheath tube, with distal openings, reusable				
	Suction irrigation tube WL 410 mm	5.0 mm	410 mm	8584732

III23 || Subject to modifications. Please note that some products may not be available in all countries. Please always take note of the information that is provided with the product. For more detailed information, please consult with your contact partner or directly with Richard Wolf GmbH.

ACCESSORIES / DISPOSABLE HAND BLOWER FOR SUCTION AND IRRIGATION



		Outer Ø	WL	Product no.
	Suction irrigation tube Ø 3 mm WL 300 mm	3.0 mm	330 mm	8383.72
with Luer connector				



		Outer Ø	WL	Product no.
	HF coagulation suction device mono Ø 5 mm WL 315 mm	5.0 mm	315 mm	8383.71
with Luer connector and a valve	HF coagulation suction device mono Ø 5 mm WL 350 mm	5.0 mm	450 mm	8384.71

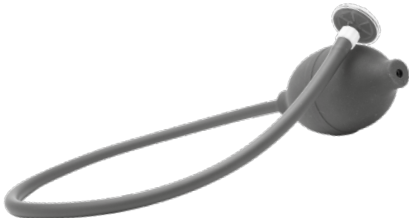

for air insufflation		Ø	TL	Product no.
	Hand blower with disposable filter, sterile (PACK= 5 PCS)	49 mm	567 mm	412700

HF connection cable: see sheet BDE116/117

TISSUE RETRACTOR 5 MM

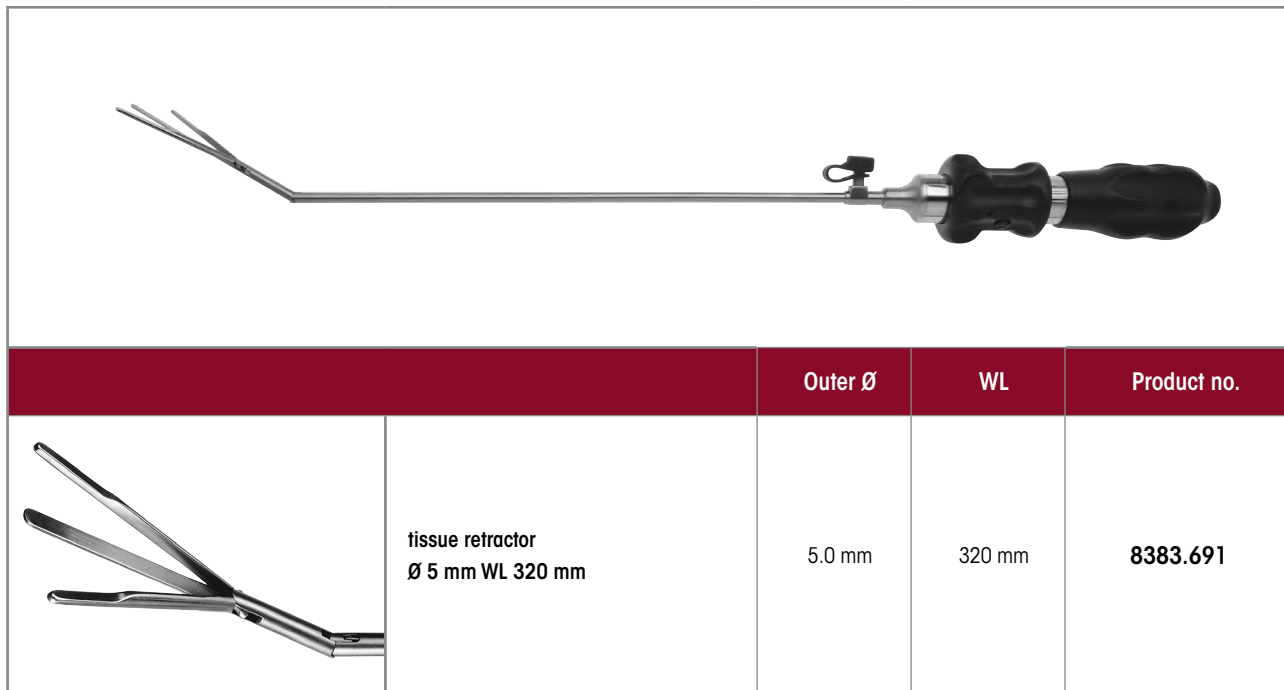



		Outer Ø	WL	Product no.
	tissue retractor Ø 5 mm WL 320 mm	5.0 mm	320 mm	8383.691

Accessories	Product no.
Luer sealing cap	887.00

III23 || Subject to modifications. Please note that some products may not be available in all countries. Please always take note of the information that is provided with the product. For more detailed information, please consult with your contact partner or directly with Richard Wolf GmbH.

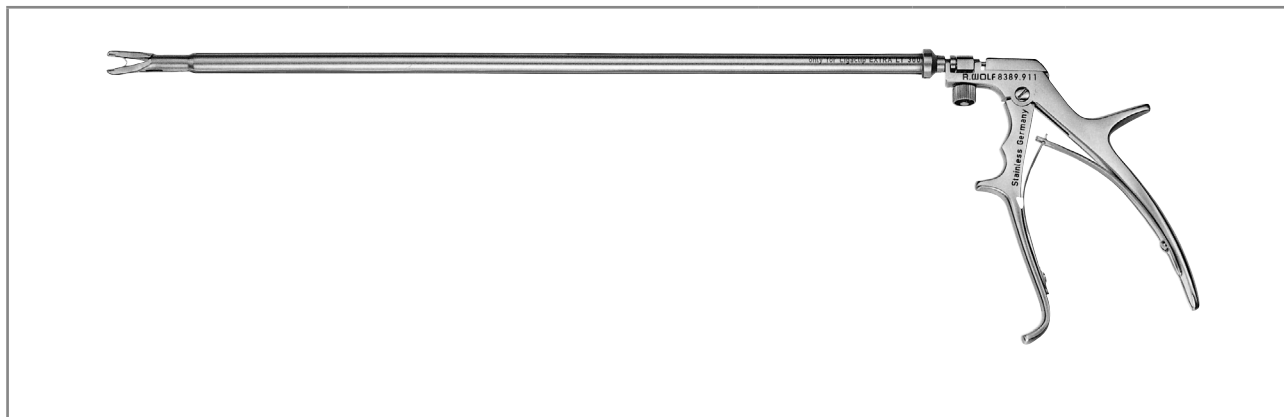
CLIP APPLICATOR 10 MM FOR SUCTION AND IRRIGATION



		Outer Ø	WL	Product no.
	Clip applicator Ø 10 mm WL 340 mm	10 mm	340 mm	8389.911
for this:				Product no.
	Introduction sleeve 10 mm WL 80 mm with sealing cap			8389.991
For clip ligation with Ethicon® Ligaclip® EXTRA LT 300				
Ethicon® Ligaclips® (PACK= 108 PCS)				8389.915

Accessories	Product no.
Sealing cap capacity 9.5–10.1 mm	89.08

ERAGON^{stitch}

THE ERGONOMIC GENERATION OF NEEDLE HOLDERS

Thanks to the custom combination options it offers, **ERAGON^{stitch}** can accommodate any user requirement. The way in which it brings together ergonomics, versatility, modularity, and precision sets new standards in comfort

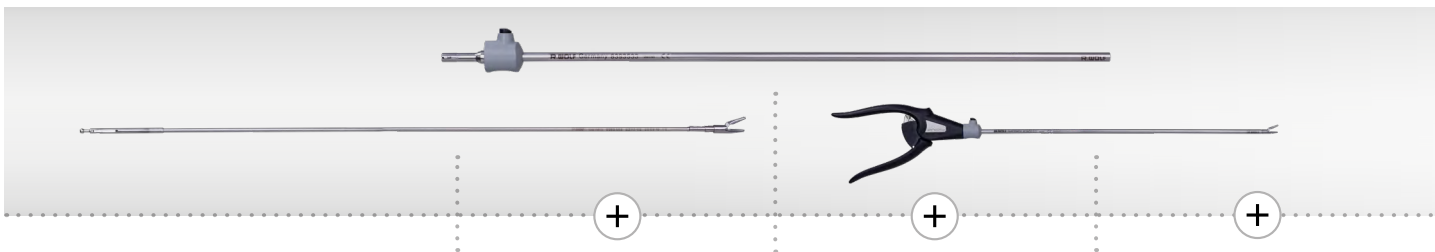

Choose working length

Choose jaw insert

Choose sheath tube

Choose handle





<p>∅ 5.0 mm</p>	<p>330 mm 450 mm</p>			
<p>∅ 3.5 mm</p>	<p>240 mm 330 mm</p>			

ERAGONstitch needle holders



ERAGON^{stitch}
NEEDLE HOLDER Ø 3.5 MM



Needle holder jaw insert			Sheath tube, Ø 3.5 mm		Needle holder handle		Complete instrument • Jaw insert • Sheath tube • Handle
							
							SL 240 mm
					Axial	Angled	
	JL*	Product no.	8390533	8391533	8393943	8393944	Product no.
	12 mm	8391505	•		•		83915053
			•		•		83915054
straight with carbide insert single-action		8391506		•	•		83915063
				•		•	83915064





* JL = jaw length when jaw section closed (approximate measurements)

Accessories for manual and machine reprocessing	Product no.
 Irrigation adapter cleaning Ø 9 mm, length 64 mm for uninsulated sheath tubes	163503

1123 || Subject to modifications. Please note that some products may not be available in all countries. Please always take note of the information that is provided with the product. For more detailed information, please consult with your contact partner or directly with Richard Wolf GmbH.

ERAGON^{stitch}



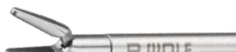
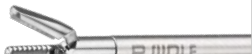

NEEDLE HOLDER Ø 5.0 MM

Needle holder jaw insert			Sheath tube, Ø 5.0 mm		Needle holder handle		Complete instrument • Jaw insert • Sheath tube • Handle	
								
	JL*	Product no.	8393533	8394533	8393943	8393944	Product no.	
 straight with carbide insert single-action	19 mm	Needle holder Ø 5 mm bndl	•		•		83935073	
			•			•	83935074	
				•	•	•	•	83945073
				•	•	•	•	83945074
 straight and narrow with carbide insert single-action	19 mm	Needle holder Ø 5 mm bndl	•		•		83935083	
			•			•	83935084	
				•	•	•	•	83945083
				•	•	•	•	83945084
 straight, with self-righting function single-action	19 mm	Needle holder jaw insert Ø 5 mm bndl	•		•		83935093	
			•			•	83935094	
				•	•	•	•	83945093
				•	•	•	•	83945094

* JL = jaw length when jaw section closed (approximate measurements)

Accessories for manual and machine reprocessing	Product no.
 Irrigation adapter cleaning Ø 9 mm, length 64 mm for uninsulated sheath tubes	163503

ERAGON *stitch*
NEEDLE HOLDER Ø 5.0 MM

Needle holder jaw insert			Sheath tube, Ø 5.0 mm		Needle holder handle		Complete instrument • Jaw insert • Sheath tube • Handle	
								
	JL*	Product no.	8393533	8394533	Axial	Angled	Product no.	
 Needle holder Ø 5 mm bndl 19 mm curved right with carbide insert single-action		8393518	•		•		83935183	
			•			•	83935184	
		8394518		•		•		83945183
				•		•		83945184
 Needle holder Ø 5 mm bndl 19 mm Curved left with carbide insert single-action		8393519	•		•		83935193	
			•			•	83935194	
		8394519		•		•		83945193
				•		•		83945194











Accessories for manual and machine reprocessing	Product no.
 Irrigation adapter cleaning Ø 9 mm, length 64 mm for uninsulated sheath tubes	163503

III23 || Subject to modifications. Please note that some products may not be available in all countries. Please always take note of the information that is provided with the product. For more detailed information, please consult with your contact partner or directly with Richard Wolf GmbH.

NEEDLE HOLDER Ø 3.5 MM/5 MM

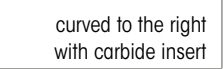
MODULAR SYSTEM

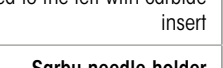

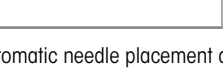

Needle holder jaw insert with sheath				Needle holder handle, axial		Complete instrument • Jaw insert • Sheath tube • Handle
						
	Product no.	Ø	SL	8393.941	Product no.	
 with carbide insert	8391504	3.5 mm	340 mm	•	8391.501	
 for straight needles	8393504	5 mm	340 mm	•	8393.501	
 with carbide insert	8393505	5 mm	340 mm	•	8393.502	
 with carbide insert	8394505	5 mm	430 mm	•	8394.502	
 curved to the right with carbide insert	8393514	5 mm	340 mm	•	8393.511	
 curved to the right with carbide insert	8394514	5 mm	430 mm	•	8394.511	
 curved to the left with carbide insert	8393515	5 mm	340 mm	•	8393.512	
 curved to the left with carbide insert	8394515	5 mm	430 mm	•	8394.512	
 Sarbu needle holder Ø 5 mm bndl	8393506	5 mm	340 mm	•	8393.503*	
 Sarbu needle holder Ø 5 mm bndl	8394506	5 mm	430 mm	•	8394.503*	

* with automatic needle placement apparatus and cutting edge

1123 || Subject to modifications. Please note that some products may not be available in all countries. Please always take note of the information that is provided with the product. For more detailed information, please consult with your contact partner or directly with Richard Wolf GmbH.

NEEDLE HOLDER HANDLE







Needle holder handle, axial	not rotatable	with lock	without HF	Product no.
	•	•	•	8393.941



Needle holder handle <small>ERAGON</small> <small>stitch</small>	axial	angled	with on-off detent mechanism	single-action	Not rotatable	Product no.
	•		•	•	•	8393943
		•	•	•	•	8393944

III23 || Subject to modifications. Please note that some products may not be available in all countries. Please always take note of the information that is provided with the product. For more detailed information, please consult with your contact partner or directly with Richard Wolf GmbH.

ERAGON modular

MODULAR KNOT PUSHER Ø 5.0 MM, INSULATED

		Handle, axial			
 All jaw inserts and sheath tubes can also be combined with ERAGONaxial					
		with lock	without lock, with HF connector	without lock, with HF connector	with lock, not rotatable
Rotatable knob	Product no.	83930082	83930083	83930084	83930085
	8988	•	•	•	•

Jaw insert		Sheath tube, Ø 5.0 mm, insulated		Handle	Complete instrument • Jaw insert with sheath tube • Handle	
  JL		SL 330 mm	SL 450 mm	 with lock, without HF		
	JL*	Product no.	8393933	8394933	83930072	Product no.
Knot pusher Ø 5 mm bndl	17 mm	8393.345	•		•	83933457
with distal recess, double-action		8394345		•	•	83943457



* JL = jaw length when jaw section closed (approximate measurements)

HF connection cable: see sheet BDE116/117

1123 || Subject to modifications. Please note that some products may not be available in all countries. Please always take note of the information that is provided with the product. For more detailed information, please consult with your contact partner or directly with Richard Wolf GmbH.

KNOT PUSHER 5 MM
FOR ENDOSCOPIC SUTURING



		Outer Ø	WL	TL	Product no.
	Knot pusher Ø 3.7 mm WL 330 mm for intraabdominal knots	3.7 mm	330 mm	380 mm	8383.55
	Knot pusher Ø 3.7 mm WL 330 mm for extracorporeal knots	3.7 mm	330 mm	380 mm	8383.551





		Outer Ø	WL	TL	Product no.
	Knot pusher Ø 5 mm WL 330 mm as per Bueß with distal notch and lateral opening for optimum knotting, extremely atraumatic tip for use as a surgical probe	5.0 mm	330 mm	380 mm	8383.552

|||23 || Subject to modifications. Please note that some products may not be available in all countries. Please always take note of the information that is provided with the product. For more detailed information, please consult with your contact partner or directly with Richard Wolf GmbH.







Endoscopically controlled fascia closure system AS PER BUSCHE



		Product no.		
 for subcutaneous fascia suture	Sealing cone Ø 10–12 mm	8934.915		
	Sealing cone Ø 12–15 mm	8943.915		
	Sealing cone Ø 15–20 mm	8945.915		
		Ø	WL	Product no.
 Needle forceps with active suture holder	Needle forceps Ø 2.45 mm WL 160 mm	2.45 mm	160 mm	8756.201

11123 || Subject to modifications. Please note that some products may not be available in all countries. Please always take note of the information that is provided with the product. For more detailed information, please consult with your contact partner or directly with Richard Wolf GmbH.

CANNULAS 3.0 MM/4.7 MM

				
with Luer connector		Outer Ø	WL	Product no.
 Tip Ø 1.4 mm	Injection cannula Ø 3 mm WL 340 mm	3.0 mm	340 mm	8379.732
				
with 3 mm Luer connector		Ø	WL	Product no.
 Tip Ø 1.8 mm	Injection cannula Ø 4.7 mm WL 350 mm	4.7 mm	350 mm	8383.65
				
with suction regulator and 4 mm Luer connector		Ø	WL	Product no.
 Tip Ø 1.8 mm	Puncture cannula Ø 4.7 mm WL 320 mm	4.7 mm	320 mm	8383.49
for this:		WL	Product no.	
	Introduction sleeve size 5.5 mm WL 45 mm This sleeve prevents damage to the cannula tip when the trocar sleeve valve is opened	45 mm	8383.00	

SURGICAL PROBES



		Ø	WL	Product no.
	Surgical probe 3.5 mm WL 250 mm graduated	3.5 mm	250 mm	8379.672



		Ø	WL	Product no.
	Surgical probe Ø 5 mm WL 328 mm graduated	5.0 mm	328 mm	8383.66
	Surgical probe Ø 5 mm WL 448 mm graduated	5.0 mm	448 mm	8384.66

11123 || Subject to modifications. Please note that some products may not be available in all countries. Please always take note of the information that is provided with the product. For more detailed information, please consult with your contact partner or directly with Richard Wolf GmbH.

MYOMA DRILL 5 MM/10 MM



		Ø	WL	Product no.
	Myoma drill Ø 5 mm WL 320 mm	5 mm	320 mm	8383.611
	Myoma drill Ø 10 mm	10 mm	340 mm	8385.301

III23 || Subject to modifications. Please note that some products may not be available in all countries. Please always take note of the information that is provided with the product. For more detailed information, please consult with your contact partner or directly with Richard Wolf GmbH.

INSUFFLATOR HIGHFLOW 45 BASIC



		Product no.
Insufflator 45 BASIC bndI consisting of: Insufflator 45 BASIC FR 45 l/min (2235001), Insufflation tube set L 2.5 m (8170.101), Hygiene filter, sterile, disposable (PACK= 10 PCS) (4171.111) and power cable 3 m long (2440.03)		22350011
Accessories: Tube sets for insufflation		
Insufflation tube set L 2.5 m, High Flow, D = 8 mm, autoclavable		8170.232
Insufflation tube set L 2.5 m, autoclavable		8170.101
Insufflation tube set L 2.7 m, with integrated hygiene filter, disposable, (PACK= 10 PCS) in individual sterile packaging		4170.501
Hygiene filter, sterile, disposable (PACK= 10 PCS) in individual sterile packaging		4171.111
Accessories for gas supply		
CO ₂ connection tube 1.5 m NIST-NIST		74021038
with		
Pressure reducer for CO ₂ connector DIN 477-1	DIN 477-1	74007054
Pressure reducer for CO ₂ connector DIN EN ISO 407	DIN EN ISO 407	74007055
Pressure reducer for CO ₂ connector ISO 5145	ISO 5145	74007056
or		
Connection tube for CO ₂ 5.0 m DIN for centralized CO ₂ gas supply (Dräger)		74021039
Connection tube for CO ₂ 5.0 m NF for centralized CO ₂ gas supply (Liquid Air)		74021040
Software modules (optional)		
Software module CAN bus CAN bus interface for integration in CORE		2235101
Software module BABY MODE BABY MODE for special use in pediatrics		2235102
Software module VIDEO DISPLAY: video display using DIALOG via CAN bus		2235103

TECHNICAL DATA

INSUFFLATOR HIGHFLOW 45 BASIC

Insufflator 45 BASIC		2235001
Device properties		
Operating mode	Continuous operation	
Operating conditions	+10°C to +40°C, 30% to 75% rel. humidity, atmospheric pressure 700 hPa to 1,060 hPa	
Storage and transport conditions	-20°C to +60°C, 10% to 90% rel. humidity, atmospheric pressure 700 hPa to 1,060 hPa	
Power supply		
Mains + frequency	100–240 V~, 50/60 Hz	
Power consumption	60 VA	
Current rating	0.6–0.2 A	
Fuse	T 3.15 AH 250 V	
Regulatory standards		
Protection class to IEC/EN 60601-1 (UL 60601-1/CSA C222 No6011 – for USA)	I	
Electromagnetic compatibility (EMC)	IEC/EN 60601-1-2	
Medical Devices Directive 93/42/EEC	Class IIb	
Protection against electric shock	Type CF applied part	
Degree of protection against the ingress of liquids	IP 20 (not protected)	
Degree of protection in the presence of flammable mixtures	Device is not protected against explosions (do not operate this device in explosive atmospheres)	
Dimensions and weights		
Weight	8.9 kg (19.5 lbs)	
Dimensions (W x H x D)	300 mm x 160 mm x 455 mm	

Relevant application parameters	
Insufflation medium	Medical-grade CO ₂ (degree of purity > 99.5%)
Intraabdominal pressure	3 mmHg to 25 mmHg (± 2 mmHg) selectable in increments of 1 mmHg
Gas flow rate primary filling	1 l/min (± 50%)
Gas flow rate, High Flow	2 l/min to 45 l/min (± 20%) selectable in increments of 1 l/min
Consumption indicator	0 l to 9,999 l (± 20%)

INSUFFLATOR HIGHFLOW 45 EVAC WITH SMOKE GAS EVACUATION



		Product no.
Insufflator 45 EVAC bndl consisting of: Insufflator 45 EVAC FR 45 l/min (2235011), Insufflation tube set L 2.5 m (8170.101), Hygiene filter, sterile, disposable (PACK= 10 PCS) (4171.111), Insufflation tube set L 2.7 m with integrated hygiene filter, sterile, disposable (PACK= 10 PCS) (4170.501) Smoke gas evacuation tube set L 2.7 m, sterile, disposable (PACK= 10 PCS) (4170503) Footswitch with 1 pedal (20301031) and power cable, 3 m long (2440.03)		22350111
Accessories: Tube sets for insufflation		
Smoke gas evacuation tube set L 2.7 m, sterile, disposable (PACK= 10 PCS)		4170503
Accessories for gas supply		
CO ₂ connection tube 1.5 m NIST-NIST		74021038
with		
Pressure reducer for CO ₂ connector DIN 477-1	DIN 477-1	74007054
Pressure reducer for CO ₂ connector DIN EN ISO 407	DIN EN ISO 407	74007055
Pressure reducer for CO ₂ connector ISO 5145	ISO 5145	74007056
or		
Connection tube for CO ₂ 5.0 m DIN for centralized CO ₂ gas supply (Dräger)		74021039
Connection tube for CO ₂ 5.0 m NF for centralized CO ₂ gas supply (Liquid Air)		74021040
Software modules (optional)		
Software module CAN bus CAN bus interface for integration in CORE		2235101
Software module BABY MODE BABY MODE for special use in pediatrics		2235102
Software module VIDEO DISPLAY: video display using DIALOG via CAN bus		2235103

TECHNICAL DATA

INSUFFLATOR HIGHFLOW 45 EVAC

Insufflator 45 EVAC		2235011
Device properties		
Operating mode	Continuous operation	
Operating conditions	+10°C to +40°C, 30% to 75% rel. humidity, atmospheric pressure 700 hPa to 1,060 hPa	
Storage and transport conditions	-20°C to +60°C, 10% to 90% rel. humidity, atmospheric pressure 700 hPa to 1,060 hPa	
Power supply		
Mains + frequency	100–240 V~, 50/60 Hz	
Power consumption	60 VA	
Current rating	0.6–0.2 A	
Fuse	T 3.15 AH 250 V	
Regulatory standards		
Protection class to IEC/EN 60601-1 (UL 60601-1/CSA C222 No6011 – for USA)	I	
Electromagnetic compatibility (EMC)	IEC/EN 60601-1-2	
Medical Devices Directive 93/42/EEC	Class IIb	
Protection against electric shock	Type CF applied part	
Degree of protection against the ingress of liquids	IP 20 (not protected)	
Degree of protection in the presence of flammable mixtures	Device is not protected against explosions (do not operate this device in explosive atmospheres)	
Dimensions and weights		
Weight	8.9 kg (19.5 lbs)	
Dimensions (W x H x D)	300 mm x 160 mm x 455 mm	

Relevant application parameters	
Insufflation medium	Medical-grade CO ₂ (degree of purity > 99.5%)
Intraabdominal pressure	3 mmHg to 25 mmHg (± 2 mmHg) selectable in increments of 1 mmHg
Gas flow rate primary filling	1 l/min (± 50%)
Gas flow rate, High Flow	2 l/min to 45 l/min (± 20%) selectable in increments of 1 l/min
Consumption indicator	0 l to 9,999 l (± 20%)

INSUFFLATOR HIGHFLOW 45 HEAT WITH GAS HEATING



		Product no.
Insufflator 45 HEAT bndI consisting of: Insufflator 45 HEAT FR 45 L/min(2235021), Insufflation tube for 2235021/031 L 3 m (8170202) Hygiene filter, sterile, disposable (PACK= 10 PCS) (4171.111) and power cable 3 m long (2440.03)		22350211
Accessories: Tube sets for insufflation		
Insufflation tube set L 3 m Highflow, with heating wire and integrated hygiene filter, sterile, disposable, (PACK= 10 PCS) in individual sterile packaging		4170502
Insufflation tube for 2235021/031 L 3 m Highflow, with heating wire, autoclavable, 3.0 m The reusable tube can be used up to 100 times		8170202
Hygiene filter , sterile, disposable (PACK= 10 PCS) in individual sterile packaging		4171.111
Accessories for gas supply		
CO₂ connection tube 1.5 m NIST-NIST		74021038
with		
Pressure reducer for CO₂ connector DIN 477-1	DIN 477-1	74007054
Pressure reducer for CO₂ connector DIN EN ISO 407	DIN EN ISO 407	74007055
Pressure reducer for CO₂ connector ISO 5145	ISO 5145	74007056
or		
Connection tube for CO₂ 5.0 m DIN for centralized CO ₂ gas supply (Dräger)		74021039
Connection tube for CO₂ 5.0 m NF for centralized CO ₂ gas supply (Liquid Air)		74021040
Software modules (optional)		
Software module CAN bus CAN bus interface for integration in CORE		2235101
Software module BABY MODE BABY MODE for special use in pediatrics		2235102
Software module VIDEO DISPLAY: video display using DIALOG via CAN bus		2235103

TECHNICAL DATA

INSUFFLATOR HIGHFLOW 45 HEAT

Insufflator 45 HEAT		2235021
Device properties		
Operating mode	Continuous operation	
Operating conditions	+10°C to +40°C, 30% to 75% rel. humidity, atmospheric pressure 700 hPa to 1,060 hPa	
Storage and transport conditions	-20°C to +60°C, 10% to 90% rel. humidity, atmospheric pressure 700 hPa to 1,060 hPa	
Power supply		
Mains + frequency	100–127/220–240 V~, 50/60 Hz	
Power consumption	80 VA	
Current rating	0.8–0.3 A	
Fuse	T 3.15 AH 250 V	
Regulatory standards		
Protection class to IEC/EN 60601-1 (UL 60601-1/CSA C222 No6011 – for USA)	I	
Electromagnetic compatibility (EMC)	IEC/EN 60601-1-2	
Medical Devices Directive 93/42/EEC	Class IIb	
Protection against electric shock	Type CF applied part	
Degree of protection against the ingress of liquids	IP 20 (not protected)	
Degree of protection in the presence of flammable mixtures	Device is not protected against explosions (do not operate this device in explosive atmospheres)	
Dimensions and weights		
Weight	11.0 kg (23.3 lbs)	
Dimensions (W x H x D)	300 mm x 160 mm x 455 mm	
Relevant application parameters		
Insufflation medium	Medical-grade CO ₂ (degree of purity > 99.5%)	
Intraabdominal pressure	3 mmHg to 25 mmHg (± 2 mmHg) selectable in increments of 1 mmHg	
Gas flow rate primary filling	1 l/min (± 50%)	
Gas flow rate, High Flow	2 l/min to 45 l/min (± 20%) selectable in increments of 1 l/min	
Consumption indicator	0 l to 9,999 l (± 20%)	

INSUFFLATOR HIGHFLOW 45 EVAC + HEAT

WITH SMOKE GAS EVACUATION AND GAS HEATING



		Product no.
Insufflator 45 EVAC + HEAT bndl		
consisting of: Insufflator 45 EVAC + HEAT FR 45 l/min(2235031), Insufflation tube for 2235021/031 L 3 m (8170202), Insufflation tube set L 3 m, sterile, disposable, (PACK= 10 PCS) (4170502), Hygiene filter, sterile, disposable (PACK= 10 PCS) (4171.111), Smoke gas evacuation tube set L 2.7 m, sterile, disposable (PACK= 10 PCS) (4170503) Footswitch 1 pedal (20301031) and power cable 3 m long (2440.03)		22350311
Accessories: Tube sets for insufflation		
Insufflation tube set L 3 m Highflow, with heating wire and integrated hygiene filter, sterile, disposable, (PACK= 10 PCS) in individual sterile packaging		4170502
Insufflation tube for 2235021/031 L 3 m Highflow, with heating wire, autoclavable, 3.0 m <small>The reusable tube can be used up to 100 times</small>		8170202
Hygiene filter , sterile, disposable (PACK= 10 PCS) in individual sterile packaging		4171.111
Smoke gas evacuation tube set L 2.7 m , sterile, disposable (PACK= 10 PCS)		4170503
Accessories for gas supply		
CO₂ connection tube 1.5 m NIST-NIST		74021038
with		
Pressure reducer for CO₂ connector DIN 477-1	DIN 477-1	74007054
Pressure reducer for CO₂ connector DIN EN ISO 407	DIN EN ISO 407	74007055
Pressure reducer for CO₂ connector ISO 5145	ISO 5145	74007056
or		
Connection tube for CO₂ 5.0 m DIN for centralized CO ₂ gas supply (Dräger)		74021039
Connection tube for CO₂ 5.0 m NF for centralized CO ₂ gas supply (Liquid Air)		74021040
Software modules (optional)		
Software module CAN bus CAN bus interface for integration in CORE		2235101
Software module BABY MODE BABY MODE for special use in pediatrics		2235102
Software module VIDEO DISPLAY: video display using DIALOG via CAN bus		2235103

TECHNICAL DATA

INSUFFLATOR HIGHFLOW 45 EVAC + HEAT

Insufflator 45 EVAC + HEAT		2235031
Device properties		
Operating mode	Continuous operation	
Operating conditions	+10°C to +40°C, 30% to 75% rel. humidity, atmospheric pressure 700 hPa to 1,060 hPa	
Storage and transport conditions	-20°C to +60°C, 10% to 90% rel. humidity, atmospheric pressure 700 hPa to 1,060 hPa	
Power supply		
Mains + frequency	100–127/220–240 V~, 50/60 Hz	
Power consumption	80 VA	
Current rating	0.8–0.3 A	
Fuse	T 3.15 AH 250 V	
Regulatory standards		
Protection class to IEC/EN 60601-1 (UL 60601-1/CSA C222 No6011 – for USA)	I	
Electromagnetic compatibility (EMC)	IEC/EN 60601-1-2	
Medical Devices Directive 93/42/EEC	Class IIb	
Protection against electric shock	Type CF applied part	
Degree of protection against the ingress of liquids	IP 20 (not protected)	
Degree of protection in the presence of flammable mixtures	Device is not protected against explosions (do not operate this device in explosive atmospheres)	
Dimensions and weights		
Weight	11.0 kg (23.3 lbs)	
Dimensions (W x H x D)	300 x 160 x 455 mm	

Relevant application parameters	
Insufflation medium	Medical-grade CO ₂ (degree of purity > 99.5%)
Intraabdominal pressure	3 mmHg to 25 mmHg (± 2 mmHg) selectable in increments of 1 mmHg
Gas flow rate primary filling	1 l/min (± 50%)
Gas flow rate, High Flow	2 l/min to 45 l/min (± 20%) selectable in increments of 1 l/min
Consumption indicator	0 l to 9,999 l (± 20%)

LAPARO-CO₂-PNEU 2233



		Product no.
LAPARO-CO₂-PNEU bndl consisting of: LAPARO-CO2-PNEU 2233 FR 20 L/MIN (2233.001) Insufflation tube set L 2.5 m (8170.101), Hygiene filter, sterile, disposable (PACK= 10 PCS) (4171.111), and power cable 3 m long (2440.03)		22330011
Accessories: Tube sets for insufflation		
Insufflation tube set, L 2.7 m with integrated hygiene filter, sterile, disposable, (PACK= 10 PCS) in individual sterile packaging		4170.501
Accessories for gas supply		
CO₂ connection tube 1.5 m NIST-NIST		74021038
with		
Pressure reducer for CO₂ connector DIN 477-1	DIN 477-1	74007054
Pressure reducer for CO₂ connector DIN EN ISO 407	DIN EN ISO 407	74007055
Pressure reducer for CO₂ connector ISO 5145	ISO 5145	74007056
or		
Connection tube for CO₂ 5.0 m DIN for centralized CO₂ gas supply (Dräger)		74021039
Connection tube for CO₂ 5.0 m NF for centralized CO₂ gas supply (Liquid Air)		74021040

TECHNICAL DATA



LAPARO-CO₂-PNEU 2233

LAPARO-CO ₂ -PNEU 2233		2233.001
Device properties		
Operating mode	Continuous operation	
Operating conditions	+10°C to +40°C, 30% to 75% rel. humidity, atmospheric pressure 700 hPa to 1,060 hPa	
Storage and transport conditions	-20°C to +60°C, 10% to 90% rel. humidity, atmospheric pressure 700 hPa to 1,060 hPa	
Power supply		
Mains + frequency	100–230 V~, 50/60 Hz	
Power consumption	80 VA	
Current rating	0.8 A	
Fuse	T 2 AL 250 V	
Regulatory standards		
Protection class to IEC/EN 60601-1 (UL 60601-1/CSA C222 No6011 – for USA)	I	
Electromagnetic compatibility (EMC)	EN/IEC 60601--1--2	
Medical Devices Directive 93/42/EEC	Class IIb	
Protection against electric shock	Type CF applied part	
Degree of protection against the ingress of liquids	IP 20 (not protected)	
Degree of protection in the presence of flammable mixtures	Device is not protected against explosions (do not operate this device in explosive atmospheres)	
Maximum suction vacuum	-60 kPa	
Dimensions and weights		
Weight	9.5 kg	
Dimensions (W x H x D)	330 mm x 155 mm x 390 mm	

Relevant application parameters	
Insufflation medium	Medical-grade CO ₂ (degree of purity > 99.5%)
Intraabdominal pressure	3 mmHg to 25 mmHg (± 2 mmHg) selectable in increments of 1 mmHg
Gas flow rate primary filling	1 l/min (± 50%)
Gas flow rate, High Flow	2 l/min to 20 l/min (± 20%) selectable in increments of 1 l/min
Consumption indicator	0 l to 9,999 l (± 20%)

STERILE SMOKE

FOR SMOKE GAS DISCHARGE

 	
Product no.	
<p>Smoke set smoke filter with tube (PACK= 10 PCS) in individual sterile packaging</p>	<p>2200/47BDKBTUA123</p>

FLUID CONTROL 2225

SUCTION IRRIGATION PUMP



core

		Product no.
FLUID CONTROL 2225 Irrigation pump for Hys/Uro/Lap bndl consisting of: Irrigation pump for Hys/Uro/Lap (2225001) and power cable 3 m long (2440.03)		22250011
for this:		
Balancing module for hysteroscopy and endourology, fluid management for fluid balancing in combination with FLUID CONTROL 2225, mobile stand with integrated weighing cells and space for up to 4 irrigation fluid bags		2225023

Accessories		Product no.
Footswitch	only for use in urology and within the indication TUR/enucleation, possibility of short-term increase in pressure if visibility is poor (Flush function)	2204901

|||23 || Subject to modifications. Please note that some products may not be available in all countries. Please always take note of the information that is provided with the product. For more detailed information, please consult with your contact partner or directly with Richard Wolf GmbH.

FLUID CONTROL 2225

SUCTION IRRIGATION TUBE SETS

Irrigation			Product no.
Accessories – reusable	Tube set with piercing spike	with Luer-Lock connection, autoclavable, incl. 10 spare membranes, reusable for 20 reprocessing cycles	8171223
Accessories – disposable	Irrigation tube set with piercing spike, L 3 m	(PACK= 10 PCS), with Luer-Lock connection, sterile, disposable product	4171223
	Tube set with CARE-LOCK, L 3 m	(PACK= 10 PCS), sterile, disposable product	4171224
	Suction irrigation tube set	(PACK= 10 PCS), with piercing spike, sterile disposable product, PVC	4171225
	Day irrigation tube set	(PACK= 10 PCS), sterile, disposable product, PVC	4171226
	Patient irrigation tube set, sterile	(PACK= 10 PCS), with Luer-Lock connection, sterile, disposable product, PVC	4171227
<i>Note: Day tube and patient tube can only be used together. A new patient tube is required for each patient; the day tube can be used for up to 20 patients</i>			

Suction			Product no.
Accessories – reusable	Tube set for vacuum, incl. filter	with integrated hygiene filter, PACK= 10 PCS, service life: 30 days (connected to irrigation pump)	2206207
	Irrigation tube	L 1.2 m, with Luer-Lock, for suction irrigation handle 8385.901 and tube set 8171223 or 8170.223	817123
	Suction tube L 3 m	for suction irrigation handle 8385.901	8171402
	Secretion container, 2 l	2 liters, with lid	8170.655
	Secretion container, 2 l	2 liters, no lid	8170.6551
Accessories – disposable	Secretion container, 2.5 l	2.5 liters	41706566
	Secretion container bndl consisting of:	Secretion container 2.5 l (41706566) and secretion bag (PACK= 90 PCS) (41706564)	4170657
	Tube set for suction (2 connections)	sterile, disposable product, (PACK= 10 PCS) for connecting instruments to collecting container	T0503-01
	Angled 90° plug-in coupling	(PACK= 10 PCS) For connecting vacuum tube 2206207 to disposable container systems	0771019

FLUID CONTROL 2225

CABLE ACCESSORIES

		Product no.
Patch cable, RJ45 SFTP, 0.5 m	Cable length 0.5 m	72325378
Patch cable, RJ45 HRS TM11, 1.0 m	Cable length 1.0 m	72325429
Patch cable, RJ45 S/FTP CAT6 10 m	Cable length 10 m	72325434
Plastic caps for network socket	(PACK= 8 PCS)	5592105
Power cable	Cable length 3 m	2440.03

III23 || Subject to modifications. Please note that some products may not be available in all countries. Please always take note of the information that is provided with the product. For more detailed information, please consult with your contact partner or directly with Richard Wolf GmbH.

TECHNICAL DATA

FLUID CONTROL 2225

FLUID CONTROL 2225		2225001
Device properties		
Operating conditions		+10°C to +40°C, 30% to 75% rel. humidity, 70 to 106 kPa atmospheric pressure 3,000 m max. altitude above sea level
Storage and transport conditions		-20°C to +60°C, 10% to 90% rel. humidity 70 to 106 kPa atmospheric pressure
Power supply		
Mains + frequency		100–240 V~, 50/60 Hz
Power consumption	100 V/60 Hz	110 VA
	240 V/50 Hz	120 VA
Current rating	100 V/60 Hz	1.10 A
	240 V/50 Hz	0.50 A
Fuse		T 3.15 AH, 250 V
Regulatory standards		
Protection class (I, II)		I
Electromagnetic compatibility (EMC)		EN 60601-1/IEC 60601-1 EN 60601-1-2/IEC 60601-1-2
Medical Devices Directive 93/42/EEC		Class IIb
Housing protection rating (IP code)		IP21
Protection against electric shock		Type BF applied part
Degree of protection in the presence of flammable mixtures		Device is not protected against explosions (do not operate this device in explosive atmospheres)
Maximum suction vacuum		-60 kPa
Dimensions and weights		
Weight		8.8 kg
Dimensions (W x H x D)		300 mm x 157 mm x 436 mm
Relevant application parameters		
Nominal flow range		Hysteroscopy: 800 ml/min (max. flow, not adjustable) Endourology: 10–800 ml/min (max. flow) Laparoscopy: 0.1–1.8 l/min (max. flow)
Suction power		max. 2 l/min
Starting nominal pressure range		Hysteroscopy: 15–200 mmHg Endourology: 15–90 mmHg/20–120 cmH2O Laparoscopy: 300 mmHg (not adjustable)
Pressure		0–300 mmHg
Deficit		-9,990 to +9,990 ml/0 to 99.9 l

TECHNICAL DATA

FLUID CONTROL 2225

Balancing module		2225023
Device properties		
Operating conditions	+10°C to +40°C, 30% to 75% rel. humidity, 70 to 106 kPa atmospheric pressure 3,000 m max. altitude above sea level	
Storage and transport conditions	-20°C to +60°C , 10% to 90% rel. humidity 70 to 106 kPa atmospheric pressure	
Regulatory standards		
Electromagnetic compatibility (EMC)	EN 60601-1/IEC 60601-1 EN 60601-1-2/IEC 60601-1-2	
Housing protection rating (IP code)	IP21	
Maximum load of container scale	16 kg/4 containers of 3 l each	
Maximum load of bag scale	23 kg/4 bags of 5 l each	
Dimensions and weights		
Weight	15.4 kg	
Dimensions (W x H x D)	618 mm x 1,064 mm x 618 mm	

Footswitch		2204901
Power supply		
Power supply connection	max. 24 V	
Power consumption	max. 0.1 A	
Regulatory standards		
Electromagnetic compatibility (EMC)	EN 60601-1/IEC 60601-1	
Housing protection rating (IP code)	IPX8	
Plug	7-pin circular connector	
Cable length	4.5 m	
Dimensions and weights		
Weight	300 g	
Dimensions (W x H x D)	66 mm x 27 mm x 91 mm	

FLUID CONTROL LAP 2216

	
Product no.	
<p>FLUID CONTROL LAP suction irrigation pump bndl consisting of: LAP suction irrigation pump (2216001) and power cable 3 m long (2440.03)</p>	22160011

Accessories		Product no.
Bracket	for fixing the suction container on the irrigator stand or MUT cart	2215.992
Universal holder	for FLUID CONTROL LAP on RIWomobil	32114605

1123 || Subject to modifications. Please note that some products may not be available in all countries. Please always take note of the information that is provided with the product. For more detailed information, please consult with your contact partner or directly with Richard Wolf GmbH.

LAP SUCTION IRRIGATION PUMP 2216

SUCTION IRRIGATION TUBE SETS

Irrigation			Product no.
Accessories – reusable	Tube set with piercing spike	with Luer-Lock connection, autoclavable, incl. 10 spare membranes, reusable for 20 reprocessing cycles	8171223
	Irrigation tube set with piercing spike, L 3 m	(PACK= 10 PCS), with Luer-Lock connection, sterile, disposable product	4171223
Accessories – disposable	Tube set with CARE-LOCK, L 3 m	(PACK= 10 PCS), sterile, disposable product	4171224
	Suction irrigation tube set	(PACK= 10 PCS), with piercing spike, sterile disposable product, PVC	4171225
	Day irrigation tube set	(PACK= 10 PCS), sterile, disposable product, PVC	4171226
	Patient irrigation tube set, sterile	(PACK= 10 PCS), with Luer-Lock connection, sterile, disposable product, PVC	4171227
<i>Note: Day tube and patient tube can only be used together. A new patient tube is required for each patient; the day tube can be used for up to 20 patients</i>			

Suction			Product no.
Accessories – reusable	Tube set for vacuum, incl. filter	with integrated hygiene filter, PACK= 10 PCS, service life: 30 days (connected to irrigation pump)	2206207
	Irrigation tube	L 1.2 m, with Luer-Lock, for suction irrigation handle 8385.901 and tube set 8171223 or 8170.223	817123
	Suction tube L 3 m	for suction irrigation handle 8385.901	8171402
	Secretion container, 2 l	2 liters, with lid	8170.655
	Secretion container, 2 l	2 liters, no lid	8170.6551
Accessories – disposable	Secretion container, 2.5 l	2.5 liters	41706566
	Secretion container bndl consisting of:	Secretion container 2.5 l (41706566) and secretion bag (PACK= 90 PCS) (41706564)	4170657
	Tube set for suction (2 connections)	sterile, disposable product, (PACK= 10 PCS) for connecting instruments to collecting container	T0503-01
	Angled 90° plug-in coupling	(PACK= 10 PCS) For connecting vacuum tube 2206207 to disposable container systems	0771019

TECHNICAL DATA

FLUID CONTROL LAP 2216

LAP suction irrigation pump		2216001
Device properties		
Operating conditions	+10°C to +40°C, 30% to 75% rel. humidity, atmospheric pressure 700 hPa to 1,060 hPa 3,000 m max. altitude above sea level	
Storage conditions	+5°C to +40°C, 5% to 90% rel. humidity, atmospheric pressure 700 hPa to 1,060 hPa	
Transport and shipping conditions	-20°C to +60°C, 5% to 90% rel. humidity, atmospheric pressure 700 hPa to 1,060 hPa	
Power supply		
Mains + frequency	100–240 V~, 50/60 Hz	
Power consumption	100 V/60 Hz	65 VA
	240 V/50 Hz	96 VA
Current rating	100 V/60 Hz	0.65 A
	240 V/50 Hz	0.42 A
Protection class	I	
Electromagnetic compatibility (EMC)	IEC 60601-1/EN 60601-1 IEC 60601-1-2/EN 60601-1-2	
Medical Devices Directive 93/42/EEC	Class IIa	
Protection against electric shock	Type BF applied part	
Degree of protection against the ingress of liquids	IP 41	
Degree of protection in the presence of flammable mixtures	Device is not protected against explosions (do not operate this device in explosive atmospheres)	
Dimensions and weights		
Weight	4 kg	
Dimensions (W x H x D) with toggle screw	140 mm x 210 mm x 295 mm	

Relevant application parameters	
Maximum delivery rate	Rinsing: 2.0 l/min (± 10%), suction: 2.0 l/min (+0.4/-0.1 l/min)
Maximum pump pressure	400 mmHg (± 50 mmHg)
Motor cut-out	500 mmHg after 5 s (± 25 mmHg)
Suction pressure	between -50 kPa and -60 kPa
Connections	Equipotential bonding, vacuum connection

HF GENERATOR 2260

core

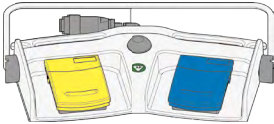

		Product no.
HF surgical generator 400 kHz	for the connection of monopolar and bipolar accessories, international version (BOWA, KLS Martin, Olympus, Karl Storz, Valleylab)	2260001
HF surgical generator 400 kHz	for the connection of monopolar and bipolar accessories, E version (Erbe)	2260002

Accessories required	Cable length	Product no.
Footswitch, 2 pedals L 5 m with fixed connection cable, reusable 		2260021
Neutral electrode for use with high-frequency surgical device, Foil bag with 5 neutral electrodes, (PACK= 50 PCS)		1280H
Mono HF neutral electrode cable, L 4.5 m	4.5 m	2260031
Power cable	3.0 m	2440.03
Bipo HF connection cable L 3 m	3.0 m	8108233
Bipo HF connection cable L 5 m	5.0 m	8108253







11123 || Subject to modifications. Please note that some products may not be available in all countries. Please always take note of the information that is provided with the product. For more detailed information, please consult with your contact partner or directly with Richard Wolf GmbH.

HF GENERATOR 2260

TECHNICAL DATA

HF surgical generator 400kHz		2260001/2260002
Device properties		
Type of controls on housing front		Touch panel
Output power	max.cutting power	400 W
	max.coagulation power	350 W
LF and HF leakage currents		acc. to DIN EN 60601 1 and DIN EN 60601 2 2
Signal level		HF indicator 55 dB(A); adjustable 45–60 dB(A) Alarm 65 dB(A)
Operating conditions		+10°C to +40°C, 30% to 75% rel humidity, 700 hPa to 1,060 hPa atmospheric pressure
Storage and transport conditions		- 20°C to + 60°C, 10% to 90% rel humidity, 700 hPa to 1,060 hPa atmospheric pressure
Power supply		
Mains + frequency		100–240 V~, 50/60 Hz
Power consumption	without HF output	45 VA
	at max. output power	650 VA
Current rating		max. 6.3 A
Fuse		T 6.3 AH 250 V
Regulatory standards		
Protection class to EN/IEC 60601-1 (UL 2601-1/CSA C222 No6011 – for USA)		I
Electromagnetic compatibility (EMC)		EN/IEC 60601-1-2
Medical Devices Directive 93/42/EEC		Class IIb
Degree of protection against the ingress of liquids (DIN EN/IEC 60529)		IPX0
Degree of protection against the ingress of solids		IP2X
Duty factor (duty cycle DC)		Intermittent INT 10 s/30 s corresponding to 25% DC
Protection against electric shock		Model CF applied part, defibrillator-proof
Degree of protection in the presence of flammable mixtures		Device is not protected against explosions (do not operate this device in explosive atmospheres)
Dimensions and weights		
Weight		10.2 kg (22.4 lbs)
Dimensions (W x H x D)		300 x 159 x 419 mm

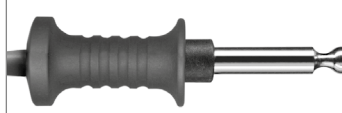
HF CONNECTION CABLE MONO 815xxx

Instrument connector	Device connector		Product no.
WOLF Resectoscopes 	 ERBE (ACC/ICC/IO)/BOWA (EU) R. Wolf HF surgical generator 400 kHz 2260002	HF connection cable mono L 3 m	815.032
		HF connection cable mono L 5 m	815.052
	 ERBE (T series)	HF connection cable mono L 3 m	815.132
		HF connection cable mono L 5 m	815.152
HF electrodes, monopolar 	 Martin (M-version)/Berchtold/ Aesculap	HF connection cable mono L 3 m	815.031
		HF connection cable mono L 5 m	815.051
	 Bovie/Valleylab/Erbe (Int.)/ BOWA (Int.) R. Wolf HF surgical generator 400 kHz 2260001	HF connection cable mono L 3 m	815.033
		HF connection cable mono L 5 m	815.053
	 BOWA (Int./EU) Eschmann and other devices with 4 mm plugs R. Wolf HF surgical generator 400 kHz 2260001	HF connection cable mono L 3 m	815.034
		HF connection cable mono L 5 m	815.054









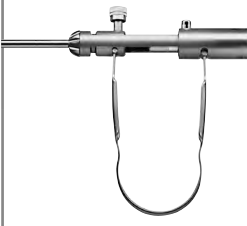

III23 || Subject to modifications. Please note that some products may not be available in all countries. Please always take note of the information that is provided with the product. For more detailed information, please consult with your contact partner or directly with Richard Wolf GmbH.

HF CONNECTION CABLE MONO 8106xxx

Instrument connector	Device connector		Product no.
<p>WOLF Instruments/surgical generator</p> 		<p>HF connection cable mono L 3 m</p>	<p>8106.032</p>
	<p>Erbe (ACC/ICC/VIO)/BOWA (EU) R. Wolf HF surgical generator 400 kHz 2260002</p>	<p>HF connection cable mono L 5 m</p>	<p>8106.052</p>
		<p>HF connection cable mono L 3 m</p>	<p>8106.132</p>
	<p>Erbe (T series)</p>	<p>HF connection cable mono L 5 m</p>	<p>8106.152</p>
<p>HF electrodes, monopolar</p> 		<p>HF connection cable mono L 3 m</p>	<p>8106.031</p>
	<p>Martin (M-version)/Berchold/ Aesculap</p>	<p>HF connection cable mono L 5 m</p>	<p>8106.051</p>
		<p>HF connection cable mono L 3 m</p>	<p>8106.033</p>
	<p>Bovie/Valleylab/Erbe (Int.)/ BOWA (Int.) R. Wolf HF surgical generator 400 kHz 2260001</p>	<p>HF connection cable mono L 5 m</p>	<p>8106.053</p>
		<p>HF connection cable mono L 3 m</p>	<p>8106.034</p>
	<p>BOWA (Int./EU) Eschmann and other devices with 4 mm plugs R. Wolf HF surgical generator 400 kHz 2260001/2260002</p>	<p>HF connection cable mono L 5 m</p>	<p>8106.054</p>





BIPO HF CONNECTION CABLE

8108xxx

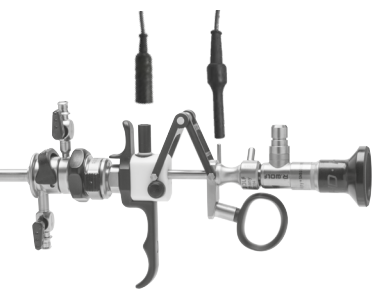

Instrument connector	Device connector		Product no.	
WOLF Bipolar forceps 	 ERBE (ACC/ICC/T)/BOWA (EU) R. Wolf HF surgical generator 400 kHz 2260001/2260002	HF connection cable bipo; L 3 m	8108.032	
		HF connection cable bipo; L 5 m	8108.052	
	 International / 2-pin Valleylab R. Wolf HF surgical generator 400 kHz 2260001/2260002	HF connection cable bipo; L 3 m	8108.033	
		HF connection cable bipo; L 5 m	8108.053	
	 WOLF/Martin (M-version)/ Berchtold/Aesculap	HF connection cable bipo; L 3 m	8108.031	
		HF connection cable bipo; L 5 m	8108.051	
	 EMC Dolley	HF connection cable bipo; L 3 m	8108035	
	Bipolar tweezers connection 	 ERBE (ACC/ICC/T)/BOWA (EU) R. Wolf HF surgical generator 400 kHz 2260001/2260002	HF connection cable bipo; L 3 m	8108.132
			HF connection cable bipo; L 5 m	8108.152
		 International / 2-pin Valleylab R. Wolf HF surgical generator 400 kHz 2260001/2260002	HF connection cable bipo; L 3 m	8108.133
HF connection cable bipo; L 5 m			8108.153	
 Martin (M-version)/Berchtold/ Aesculap		HF connection cable bipo; L 3 m	8108.131	
		HF connection cable bipo; L 5 m	8108.151	
 EMC Dolley		HF connection cable bipo; L 3 m	8108135	

III23 || Subject to modifications. Please note that some products may not be available in all countries. Please always take note of the information that is provided with the product. For more detailed information, please consult with your contact partner or directly with Richard Wolf GmbH.

HF CONNECTION CABLE BIPO FOR RESECTION IN SALINE SOLUTION

Instrument connector	Device connector		Product no.
<p>WOLF S(a)line resectoscopes</p> 	 Erbe VIO 300D	<p>Bipolar cable; TUR/TCR; WOLF</p> <p>MF plug; L 4 m</p>	<p>20196-119</p>
	 Erbe VIO 3	<p>BIPOLAR CABLE; MF-U</p> <p>MF plug; L 4.5 m</p>	<p>21196-119</p>
	 KLS Martin	<p>HF connection cable bipo; L 3 m</p>	<p>8108.231</p>
		<p>HF connection cable bipo; L 5 m</p>	<p>8108.251</p>
	 R. Wolf HF surgical generator 400 kHz 2260001/2260002		<p>8108233</p>
		<p>HF connection cable bipo; L 5 m</p>	<p>8108253</p>

MONO HF NEUTRAL ELECTRODE CABLE

Instrument connector	Device connector		Product no.
<p>2-pole neutral electrode</p> 	 <p>R. Wolf HF surgical generator 400 kHz 2260001/2260002</p>	<p>Mono HF neutral electrode cable, L 4.5 m</p>	<p>2260031</p>

III23 || Subject to modifications. Please note that some products may not be available in all countries. Please always take note of the information that is provided with the product. For more detailed information, please consult with your contact partner or directly with Richard Wolf GmbH.

FLEXIBLE FIBER CHOLEDOCHOSCOPE 5 MM CHANNEL 2.5 MM

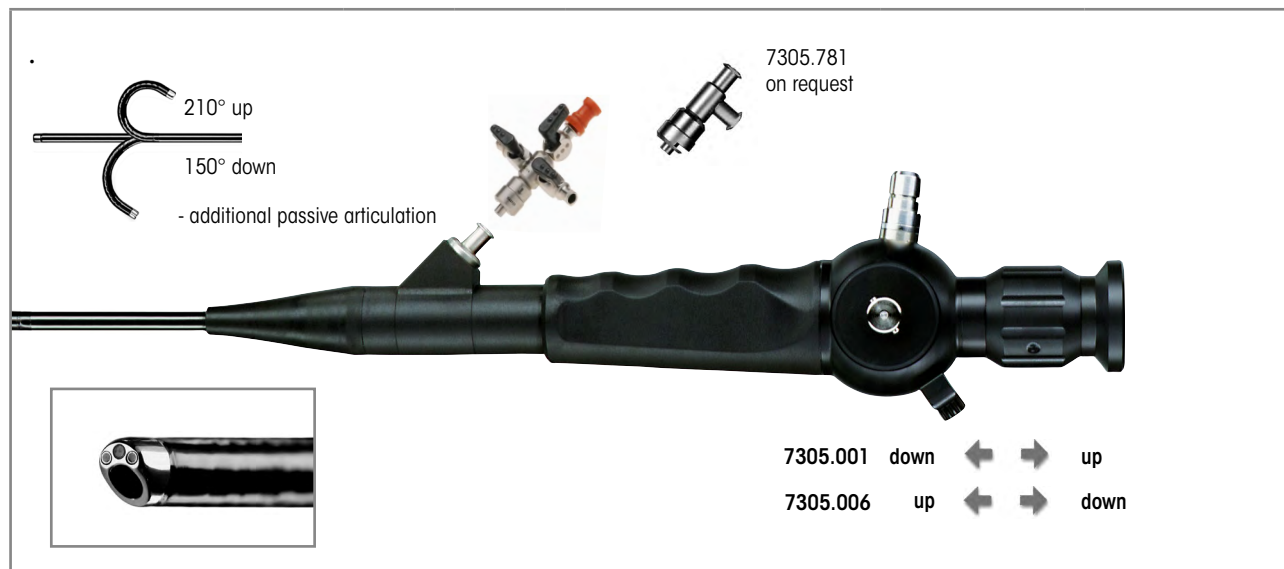

	Outer Ø	Working channel	WL	Control lever in distal direction – articulation downward	Control lever in distal direction – articulation upward	Product no.
Fiber cystoscope 15 FR WL 400 mm Slanted distal tip Articulation +210°/-150° Direction of view 0°, viewing angle 110°	5 mm 15 Fr	25 mm 75 Fr	400 mm	•		7305.001
					•	7305.006
Fiber cystoscope bndl consisting of: Fiber cystoscope 15 FR WL 400 mm (7305.001) Adapter with 2 irrigation valves and 1 instrument port (7305.782) Leakage tester for flex. endoscopes (163.903) Pressure equalization valve (163.904) Cleaning brush Ø 3 mm, TL 1,200 mm (PACK= 10 PCS) (7990002)				•		730500111
Fiber cystoscope bndl consisting of: Fiber cystoscope 15 FR WL 400 mm (7305.006) Adapter with 2 irrigation valves and 1 instrument port (7305.782) Leakage tester for flex. endoscopes (163.903) Pressure equalization valve (163.904) Cleaning brush Ø 3 mm, TL 1,200 mm (PACK= 10 PCS) (7990002)					•	730500611

Recommended accessories	Product no.
Fiber light cable bndl consisting of: Fiber light cable Ø 2.5 mm TL 2.3 m (80662523), projector-side adapter (8095.07), and endoscope-side adapter (809509)	Ø 2.5 mm, 2.3 m long 806625231

1123 | Subject to modifications. Please note that some products may not be available in all countries. Please always take note of the information that is provided with the product. For more detailed information, please consult with your contact partner or directly with Richard Wolf GmbH.

mamba
VISION

FLEXIBLE SENSOR ENDOSCOPE FOR USE IN CHOLEDOCHOSCOPY

FOR ENDOCAM **Logic 4K** CONTROLLER



	Outer Ø	Working channel	WL	Control lever in distal direction – articulation downward	Control lever in distal direction – articulation upward	Product no.
Sensor cystoscope 16.2 Fr WL 400 mm Slanted distal tip Articulation +210°/-210° Direction of view 0°, viewing angle 120°	16.2 Fr	2.5 mm 7.5 Fr	400 mm	•		7315001
				•	7315006	
Sensor cystoscope bndl consisting of: Sensor cystoscope 16.2 FR, WL 400 mm (7315001) Leakage tester for flex. endoscopes (163.903), pressure equalization valve (163.904), Luer sealing cap (15023205), and cleaning brush Ø 5 mm, TL 1,200 mm (PACK= 10 PCS) (7990005)				•		73150012
Sensor cystoscope bndl consisting of: Sensor cystoscope 16.2 FR, WL 400 mm (7315006) Leakage tester for flex. endoscopes (163.903), pressure equalization valve (163.904), Luer sealing cap (15023205), and cleaning brush Ø 5 mm, TL 1200 mm (PACK= 10 PCS) (7990005)					•	73150062
Recommended accessories						Product no.
Fiber light cable bndl consisting of: Fiber light cable Ø 2.5 mm TL 2.3 m (80662523), projector-side adapter (8095.07), and endoscope-side adapter (809509)				Ø 2.5 mm, 2.3 m long		806625231

III23 || Subject to modifications. Please note that some products may not be available in all countries. Please always take note of the information that is provided with the product. For more detailed information, please consult with your contact partner or directly with Richard Wolf GmbH.

TÜBINGER MIC TRAINING DEVICE

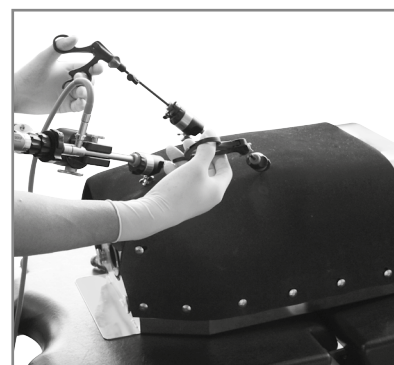
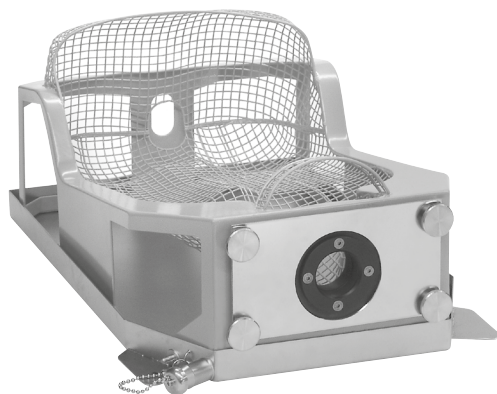

		Product no.
Tübinger MIC trainer with 3 abdominal walls (foam rubber)	(W x H x D) 560 x 350 x 230 mm	9500.056

Recommended accessories		Product no.
Abdominal wall, foam rubber, PACK= 5 PCS		9500.0561
Available on request with transportation case		

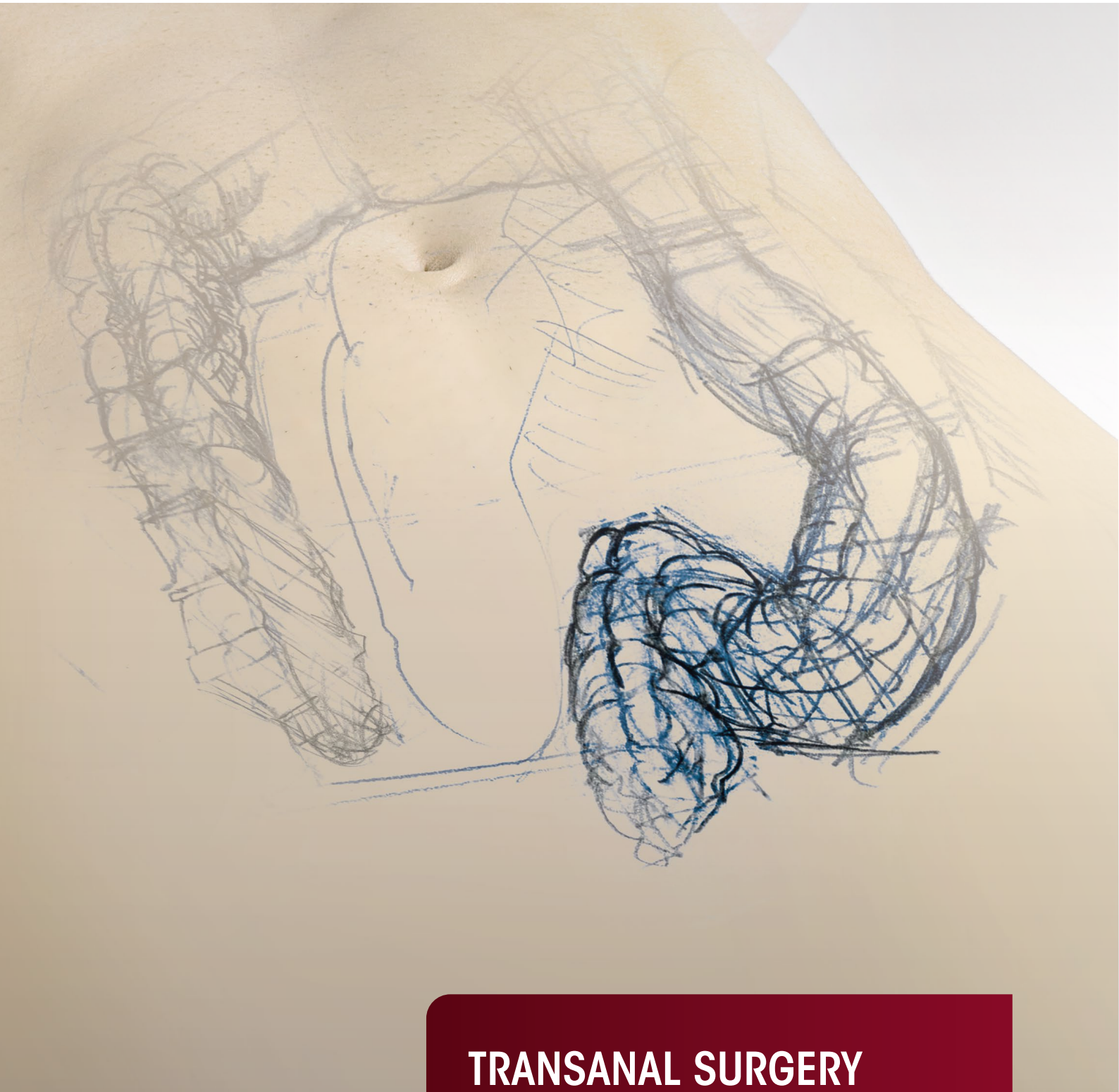

TRANSANAL SURGERY

TRANSANAL SURGERY

1

BASIC SET

2

TEM SYSTEM/STEREO AND DOCUMENTATION TELESCOPE

3

SUPPORT ARM SYSTEM

4

TEM INSTRUMENT SET

5

ACCESSORIES FOR TEM COMBINATION SYSTEM 2232

6

HF CONNECTION CABLE

Note:

The TEM pumps/devices combination system is no longer available as of May 2021.
The following related instruments are still available to existing customers.

BASIC TEM SET

TRANSANAL ENDOSCOPIC SURGERY

Product	Product no	Quantity	Catalog/Section
PANOVIEW stereo endoscope 50° Ø 13.8 mm SL 259 mm	884080	1	TEM/system
TEM basic part	8840.20	1	TEM/system
TEM tube bndl	8840.021	1	TEM/system
TEM tube bndl	8840.041	1	TEM/system
Adapter with observation window	8840.25	1	TEM/system
Working insert for TEM	8840.241	1	TEM/system
Silicone sealing insert	8840.242	1	TEM/system
Sealing caps			
Sealing cap capacity 2.4–3.4 mm, red-orange (PACK= 10 PCS)	89.01	1	TEM/system
Sealing cap capacity 3.4–5.1 mm, sky-blue (PACK= 10 PCS)	89.02	1	TEM/system
Sealing cap capacity 5.1–6.0 mm, light gray (PACK= 10 PCS)	89.03	1	TEM/system
Sealing cap capacity 4–6 mm, red (PACK= 10 PCS)	89.141	1	TEM/system
Sealing cap capacity 7.5–8.5 mm, blue (PACK= 10 PCS)	89.161	1	TEM/system
Sealing cap capacity 13.0–13.8 mm, gray (PACK= 10 PCS)	89.10	1	TEM/system
HF suction tube TEM Ø 5.6 mm WL 305 mm	8840.731	1	TEM/instrument set
HF knife Ø 4.5 mm WL 433 mm, right	8840.711	1	TEM/instrument set
HF knife Ø 4.5 mm WL 433 mm, left	8840.712	1	TEM/instrument set
ERAGONmodular TEM grasping forceps mono Ø 5 mm bndl			
angled downward and curved to the right	83946217	1	TEM/instrument set
angled downward and curved to the left	83946227	1	TEM/instrument set
curved to the right	83946237	1	TEM/instrument set
curved to the left	83946247	1	TEM/instrument set
Metzenbaum scissors mono Ø 5 mm bndl	83940417	1	TEM/instrument set
Needle holder Ø 5 mm, angled downward	8840.605	1	TEM/instrument set
Titanium clip for TEM, PACK= 10 units (6 PCS)	4840764	1	TEM/instrument set

STEREO AND DOCUMENTATION TELESCOPE

TEM SYSTEM

2



	Direction of view	SL	TL	Ø	Product no.
<p>PANOVIEW Stereo endoscope 50° Ø 13.8 mm SL 259 mm</p> <p>with direct stereo and lateral documentation eyepiece, with irrigation channel</p>	50°	259 mm	410 mm	13.8 mm	884080

Recommended accessories		Product no.
<p>Perforated basket for stereo telescope inner dimensions (W x H x D): 451 x 130 x 189 mm, outer dimensions (W x H x D): 477 x 139 x 196 mm</p>		38010
<p>Fiber light cable bndl consisting of: Fiber light cable Ø 5 mm TL 2.3 m (80655023), projector-side adapter (8095.07), and endoscope-side adapter (809509)</p>	Ø 5.0 mm, 2.3 m long	806650231
<p>Fusion Fiber light cable bndl consisting of: Fiber light cable Ø 5 mm TL 2.3 m (80655023), projector-side adapter (8095.07), and endoscope-side adapter (809509)</p>	Ø 5.0 mm, 2.3 m long	806550231

1123 | Subject to modifications. Please note that some products may not be available in all countries. Please always take note of the information that is provided with the product. For more detailed information, please consult with your contact partner or directly with Richard Wolf GmbH.

ALTERNATIVES

TO STEREO AND DOCUMENTATION TELESCOPE 884080

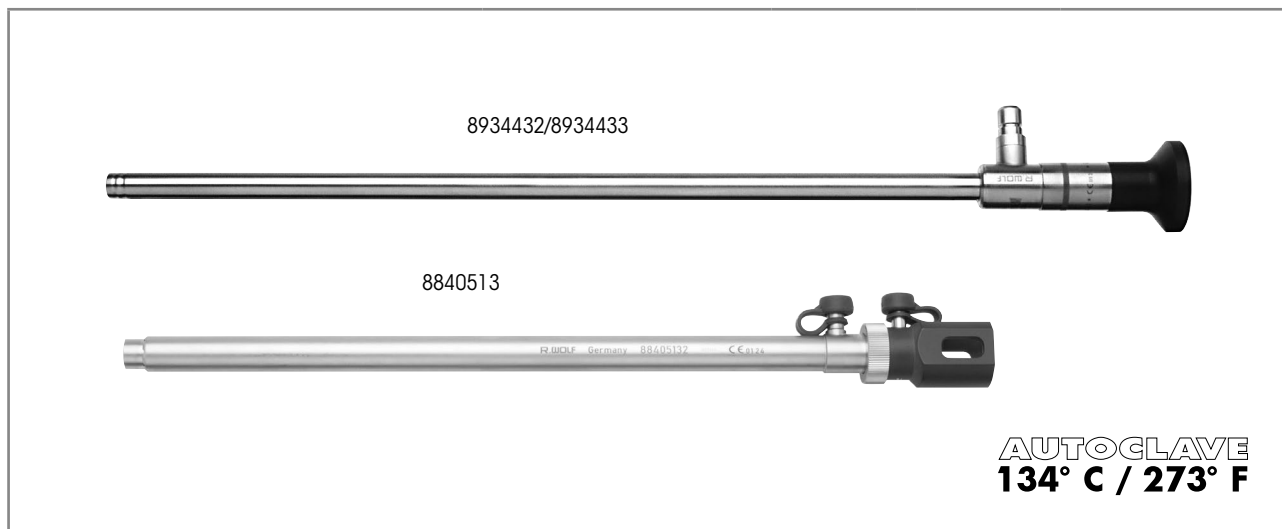

	Direction of view	WL	TL	Ø	Product no.
PANOVIEW Telescope 30° Ø 10 mm WL 307 mm	30°	307 mm	375 mm	10 mm	8934.432
PANOVIEW Telescope 50° Ø 10 mm WL 310 mm	50°	310 mm	375 mm	10 mm	8934.433
also:					
Telescope cover tube bndl	consisting of: TEM inner tube Ø 11.5 mm WL 282 mm (88405131) TEM outer tube Ø 14 mm WL 272 mm (88405132) Tube with Luer-Lock connector Ø 4 mm (886.01) Tube with Luer-Lock connector (886.00)				8840513

Recommended accessories		Product no.
Perf. basket for standard telescope 2	inner dimensions (W x H x D): 454 x 52 x 40 mm, outer dimensions (W x H x D): 481 x 54 x 59 mm	38016
Fiber lightcable bndl consisting of: Fiber light cable Ø 5 mm TL 2.3 m (80665023), projector-side adapter (8095.07), and endoscope-side adapter (809509)	Ø 5.0 mm, 2.3 m long	806650231
Fusion Fiber light cable bndl consisting of: Fiber light cable Ø 5 mm TL 2.3 m (80655023), projector-side adapter (8095.07), and endoscope-side adapter (809509)	Ø 5.0 mm, 2.3 m long	806550231

TEM INSTRUMENT SET

PROCTOSCOPE TUBES

TEM SYSTEM

2

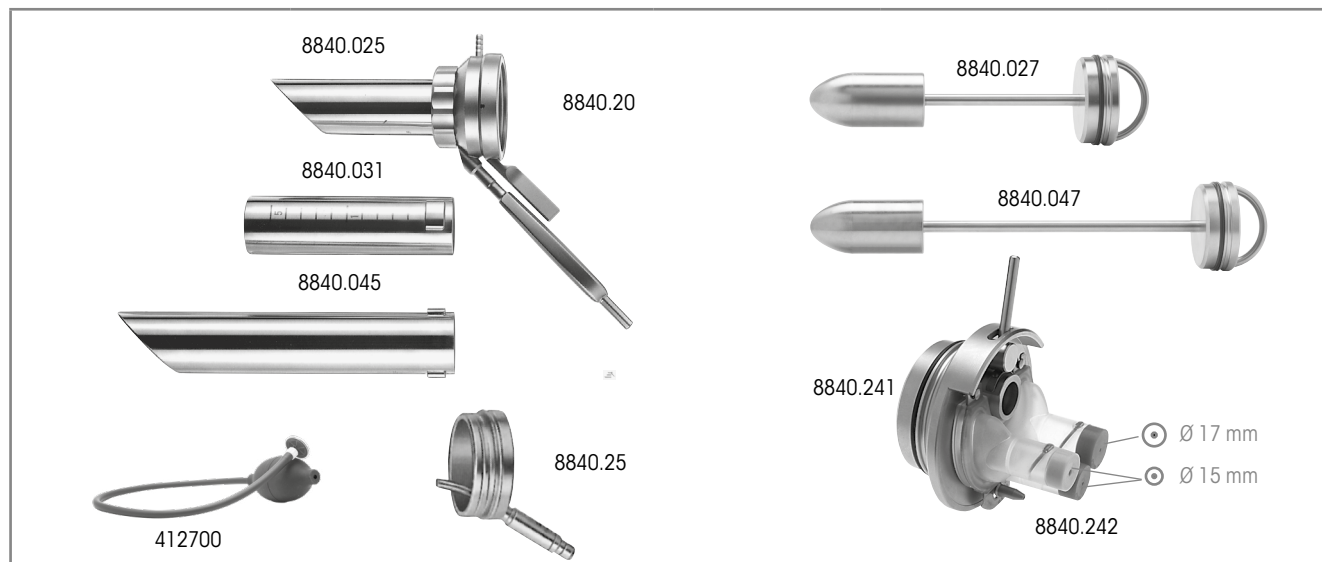

	TEM obturator Ø 36 mm WL 175 mm 8840.027	TEM obturator Ø 36 mm WL 255 mm 8840.047	Product no.
TEM tube bndl consisting of: TEM tube Ø 40 mm WL 137 mm (8840.025), TEM obturator Ø 36 mm WL 175 mm (8840.027)	•		8840.021
TEM tube bndl consisting of: TEM tube Ø 40 mm WL 137 mm (8840.031), TEM obturator Ø 36 mm WL 175 mm (8840.027)	•		8840.0311
TEM tube bndl consisting of: TEM tube Ø 40 mm WL 217 mm (8840.045), TEM obturator Ø 36 mm WL 255 mm (8840.047)		•	8840.041
TEM basic part			8840.20
Adapter with observation window and illumination insert for basic part 8840.20			8840.25
Working insert for TEM bndl consisting of:	Working insert for TEM (8840.241) Silicone sealing insert (8840.242) Sealing cap capacity 2.4–3.4 mm, red-orange (89.01) Sealing cap capacity 3.4–5.1 mm, sky-blue (89.02) Sealing cap capacity 5.1–6.0 mm, light gray (89.03) Sealing cap capacity 4–6 mm, red (89.141) Sealing cap capacity 7.5–8.5 mm, blue (89.161) Sealing cap capacity 13.0–13.8 mm, gray (89.10)		8840.2411
Hand blower sterile (PACK= 5 PCS) Hand blower with disposable filter Ø 49 mm, TL 567 mm			412700

1123 | Subject to modifications. Please note that some products may not be available in all countries. Please always take note of the information that is provided with the product. For more detailed information, please consult with your contact partner or directly with Richard Wolf GmbH.

TEM INSTRUMENT SET

PROCTOSCOPE TUBES

Spare parts	Product no.
Silicone sealing insert (PACK= 3 PCS) with 3 valve ports, (2 valve ports for auxiliary instruments up to 6 mm), (1 valve port for auxiliary instruments from 6 to 11 mm)	8840.242
Sealing cap capacity 2.4–3.4 mm , red-orange (PACK= 10 PCS)	89.01
Sealing cap capacity 3.4–5.1 mm , sky-blue (PACK= 10 PCS)	89.02
Sealing cap capacity 5.1–6.0 mm , light gray (PACK= 10 PCS)	89.03
Sealing cap capacity 4–6 mm , red (PACK= 10 PCS)	89.141
Sealing cap capacity 7.5–8.5 mm , blue (PACK= 10 PCS)	89.161
Sealing cap capacity 13.0–13.8 mm , gray (PACK= 10 PCS)	89.10

U-SHAPED SUPPORT ARM



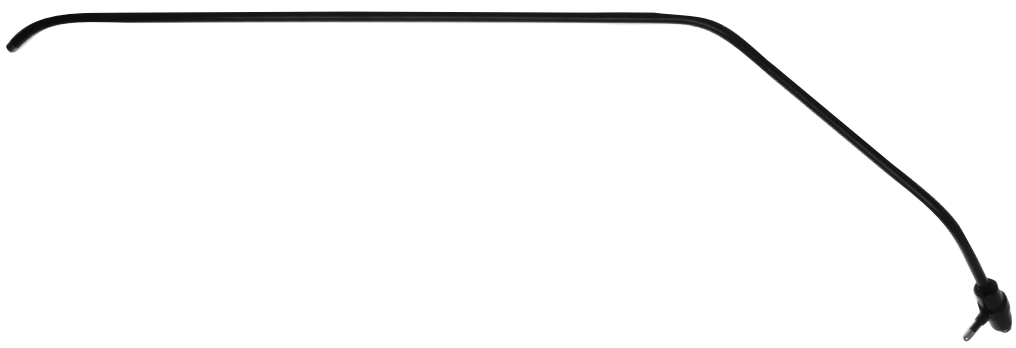

		Product no.
U-shaped support arm for TEM with clamping prism	reusable	8840.9721
Also required:		
Clamp socket insulated	for attachment to the operating table (standard rail), reusable	88409722

HF SUCTION TUBE / HF KNIFE



		Ø	WL	Product no.
 curved	HF suction tube TEM Ø 5.6 mm WL 305 mm integrated HF electrode, capacity 3 mm	6 mm	305 mm	8840.731



with ceramic insulation		Ø	WL	Product no.
 curved	HF knife Ø 4.5 mm WL 433 mm for right-handed users	4.5 mm	433 mm	8840.711
 curved	HF knife Ø 4.5 mm WL 433 mm for left-handed users	4.5 mm	433 mm	8840.712







HF connection cable: see page TEM16







ERAGON modular

TEM GRASPING FORCEPS Ø 5.0 MM INSULATED

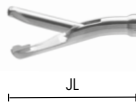
INSTRUMENT SET

4







		Handle, axial			
 All jaw inserts and sheath tubes can also be combined with ERAGONaxial.					
		with lock	without lock, with HF connector	without lock, with HF connector	with lock, not rotatable
Rotatable knob	Product no.	83930082	83930083	83930084	83930085
	8988	•	•	•	•

Jaw insert		Sheath tube, Ø 5.0 mm, insulated		Handle, pistol-shaped	Complete instrument
 					• Jaw insert with sheath tube • Handle
	JL*	Product no.	8394933	83930074	Product no.
 angled downward and curved to the right single-action	28 mm	8394621	•	•	83946217
 angled downward and curved to the left single-action	28 mm	8394622	•	•	83946227
 curved to the right single-action	25mm	8394623	•	•	83946237

* JL = jaw length when jaw section closed (approximate measurements)
 HF connection cable: see page TEM16

ERAGON modular

TEM GRASPING FORCEPS / SCISSORS Ø 5.0 MM INSULATED







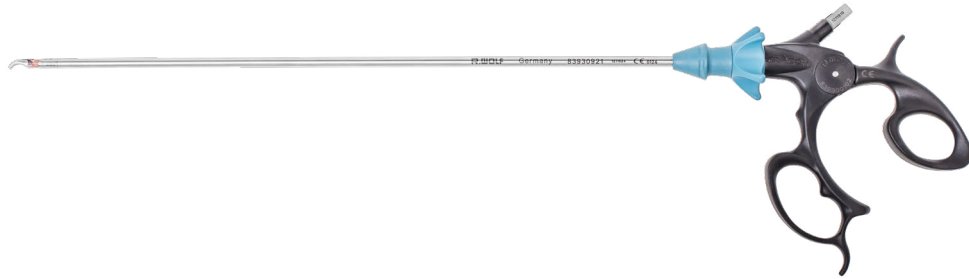

Jaw insert			Sheath tube, Ø 5.0 mm, insulated	Handle, pistol-shaped		Complete instrument • Jaw insert with sheath tube • Handle
			 WL 450 mm	 without lock, with HF, mono	 with lock, with HF, mono	
	JL*	Product no.	8394933	83930073	83930074	Product no.
TEM grasping forceps mono Ø 5 mm bndl  curved to the left single-action	25 mm	8394624	•		•	83946247
Metzenbaum scissors mono Ø 5 mm bndl  double-action	23 mm	8394.041	•	•		83940417

* JL = jaw length when jaw section closed (approximate measurements)
 HF connection cable: see page TEM16

1123 || Subject to modifications. Please note that some products may not be available in all countries. Please always take note of the information that is provided with the product. For more detailed information, please consult with your contact partner or directly with Richard Wolf GmbH.

ERAGON bipolar
MODULAR BIPOLAR INSTRUMENTS, 5.5 MM
ROTATABLE







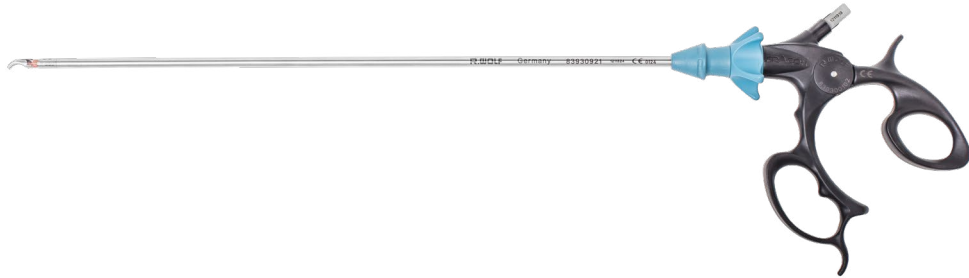

Jaw insert		Sheath tube Ø 5.5 mm		Handle, pistol-shaped, bipo	Complete instrument • Jaw insert • Sheath tube • Handle	
						
		SL 320 mm	SL 435 mm	rotatable		
	JL*	Product no.	83930921	82340024	839300102	Product no.
 Grasping forceps bipo Ø 5.5 mm bndl	21 mm	83930031	•		•	839300312
		839400310			•	
 Maryland dissector bipo Ø 5.5 mm bndl	23 mm	83930032	•		•	839300322
		839400320			•	
 Dolphin dissector bipo Ø 5.5 mm bndl	21 mm	83930033	•		•	839300332
		839400330			•	
 Grasping forceps bipo Ø 5.5 mm bndl	23 mm	83930034	•		•	839300342
		839400340			•	
 Preparation forceps bipo Ø 5.5 mm bndl	19 mm	83930035	•		•	839300352
		839400350			•	

* JL = jaw length when jaw section closed (approximate measurements)
Bipolar connection cable: see page TEM17







ERAGON bipolar
MODULAR BIPOLAR INSTRUMENTS, 5.5 MM
ROTATABLE

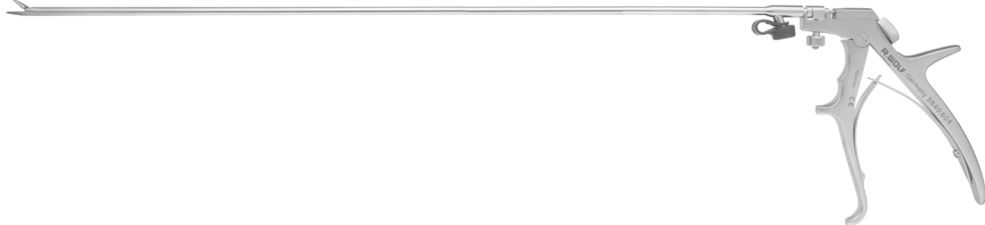

Jaw insert			Sheath tube Ø 5.5 mm		Handle, pistol-shaped, bipo	Complete instrument • Jaw insert • Sheath tube • Handle
						
			SL 320 mm	SL 435 mm	rotatable	
	JL*	Product no.	83930921	82340024	839300102	Product no.
 Sterilization forceps bipo Ø 5.5 mm bndl by Hasskamp	19 mm	83930036	•		•	839300362
 Münster grasping forceps bipo Ø 5.5 mm bndl	22 mm	83930037	•		•	839300372
		83930038	•		•	839300382
 Maryland dissector bipo Ø 5.5 mm bndl	15 mm	839400380		•	•	839400382
 Metzenbaum scissors bipo Ø 5.5 mm bndl	22 mm	83930041	•		•	839300412
		839400410		•	•	839400412

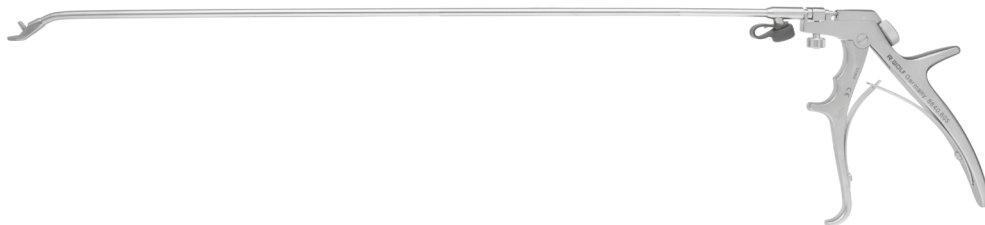
* JL = jaw length when jaw section closed (approximate measurements)
Bipolar connection cable: see page TEM17

NEEDLE HOLDER / TEM CLIP APPLICATOR / TITANIUM CLIP

				
with ceramic insulation		Ø	WL	Product no.
 straight	Needle holder Ø 5 mm	5 mm	400 mm	8840.604
				
with irrigation connector		Ø	WL	Product no.
 angled downward	Needle holder Ø 5 mm	5 mm	400 mm	8840.605
				
with irrigation tap		Ø	WL	Product no.
	TEM Clip applicator Ø 6 mm WL 435 mm	6 mm	435 mm	8840.762
Titanium clip		Ø	WL	Product no.
	Titanium clip for TEM sterile, PACK= 10 units of 6 pieces, incl. connecting part for clip	5 mm	405 mm	4840764

TEM COMBINATION SYSTEM 2232

ACCESSORIES

Spare parts	Product no.
High-pressure connection tube bndl consisting of: High-pressure connection tube L 1 m (8170.801) Open end wrench WS 30 (9500.016) with DIN connector	8170.8011
High-pressure connection tube L 1 m with PIN Index connector	8170.802
High-pressure connection tube L 1 m with ISO Index connector	8107.803
CO₂ connection tube L 5 m for centralized CO ₂ gas supply in accordance with DIN EN 13260-2/2004	8170.3111
TEM tube set sterile, disposable	4170.801
TEM tube set for Erbe instrument sterile, disposable	4170.804
Open end wrench WS 30	9500.016
Bottle holder for gas bottle Ø 80–90 mm for holding CO ₂ bottles	2221.951

HF CONNECTION CABLE MONO 8106xxx







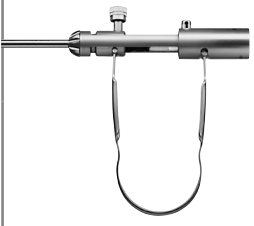

CONNECTION CABLE

6

Instrument connector	Device connector		Product no.
WOLF Instruments/surgical generator 		HF connection cable mono L 3 m	8106.032
	Erbe (ACC/ICC/VIO)/BOWA (EU) R. Wolf HF surgical generator 400 kHz 2260002	HF connection cable mono L 5 m	8106.052
		HF connection cable mono L 3 m	8106.132
	Erbe (T series)	HF connection cable mono L 5 m	8106.152
		HF connection cable mono L 3 m	8106.031
	Martin (M-version)/Berchold/ Aesculap	HF connection cable mono L 5 m	8106.051
HF electrodes, monopolar 		HF connection cable mono L 3 m	8106.033
	Bovie/Valleylab/Erbe (Int.)/ BOWA (Int.) R. Wolf HF surgical generator 400 kHz 2260001	HF connection cable mono L 5 m	8106.053
		HF connection cable mono L 3 m	8106.034
	BOWA (Int./EU) Eschmann and other devices with 4 mm plugs R. Wolf HF surgical generator 400 kHz 2260001/2260002	HF connection cable mono L 5 m	8106.054

1123 | Subject to modifications. Please note that some products may not be available in all countries. Please always take note of the information that is provided with the product. For more detailed information, please consult with your contact partner or directly with Richard Wolf GmbH.

HF BIPOLAR CONNECTION CABLE 8108XXX

Instrument connector	Device connector		Product no.
WOLF Bipolar forceps 	 Erbe (ACC/ICC/T)/BOWA (EU) R. Wolf HF surgical generator 400 kHz 2260001/2260002	HF connection cable bipo, L 3 m	8108.032
		HF connection cable bipo, L 5 m	8108.052
	 Martin (Int.)/ 2 pin Valleylab/BOWA (Int.) R. Wolf HF surgical generator 400 kHz 2260001/2260002	HF connection cable bipo, L 3 m	8108.033
		HF connection cable bipo, L 5 m	8108.053
	 WOLF/Martin (M-version)/Berchtold/ Aesculap	HF connection cable bipo, L 3 m	8108.031
		HF connection cable bipo, L 5 m	8108.051
Bipolar tweezers connection 	 Erbe (ACC/ICC/T)/BOWA (EU) R. Wolf HF surgical generator 400 kHz 2260001/2260002	HF connection cable bipo, L 3 m	8108.132
		HF connection cable bipo, L 5 m	8108.152
	 Martin (Int.)/ 2 pin Valleylab/BOWA (Int.) R. Wolf HF surgical generator 400 kHz 2260001/2260002	HF connection cable bipo, L 3 m	8108.133
		HF connection cable bipo, L 5 m	8108.153
	 Martin (m version)/Berchtold/ Aesculap	HF connection cable bipo, L 3 m	8108.131
		HF connection cable bipo, L 5 m	8108.151
 EMC Dolley	HF connection cable bipo, L 3 m	8108135	

1123 || Subject to modifications. Please note that some products may not be available in all countries. Please always take note of the information that is provided with the product. For more detailed information, please consult with your contact partner or directly with Richard Wolf GmbH.

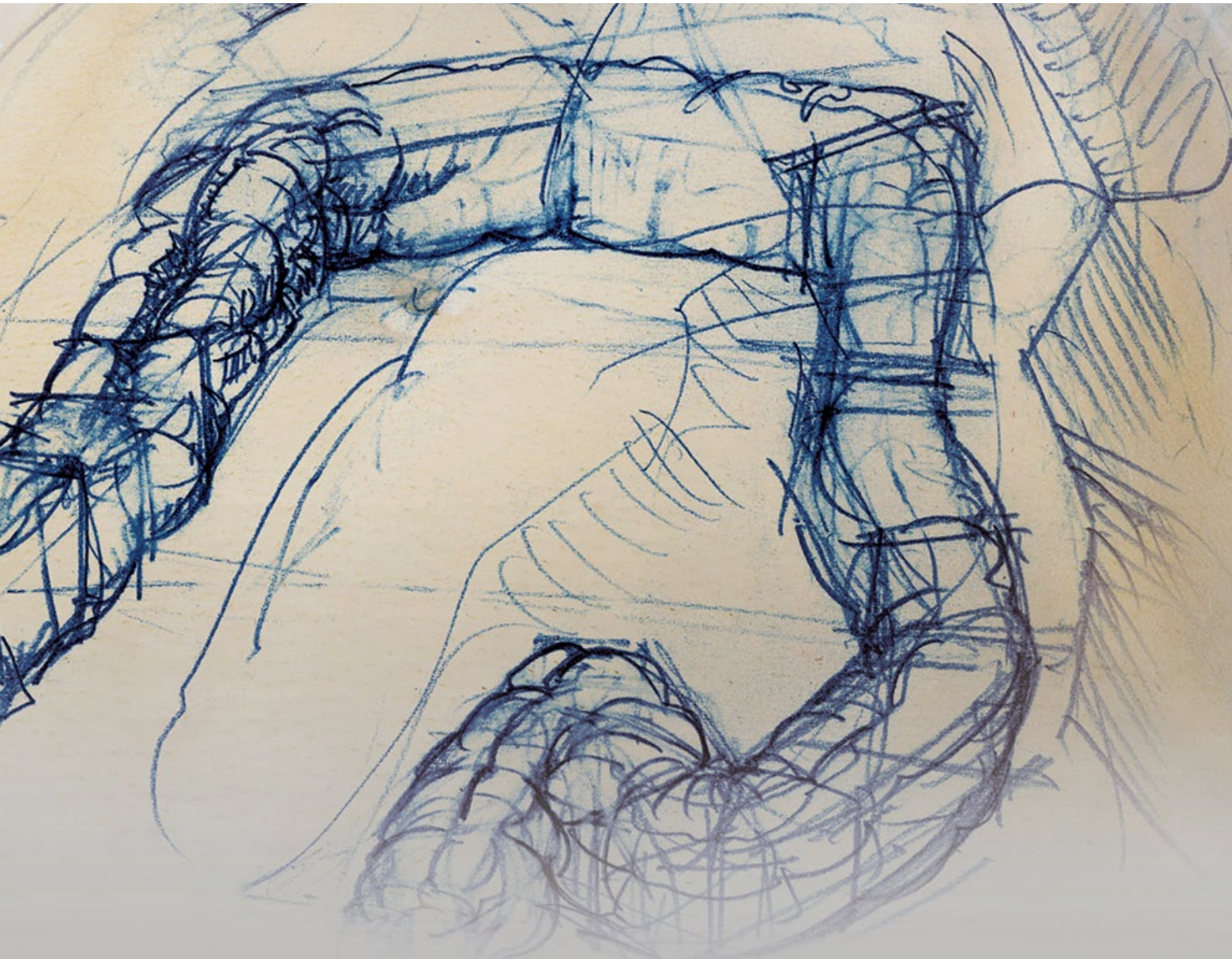

PROCTO-RECTOSCOPY

PROCTO-RECTOSCOPY

1

DISPOSABLE PROCTO-RECTOSCOPE TUBES 4844

2

PROCTOSCOPE TUBES 8836 / AUXILIARY INSTRUMENTS

3

ASPIRATION-LIGATURE INSTRUMENT FOR HAEMORRHOIDS

4

RECTOSCOPE TUBES 8834

5

OPERATING RECTOSCOPE 8834

6

AUXILIARY INSTRUMENTS FOR RECTOSCOPY

7

ADDITIONS FOR RECTOSCOPY

DISPOSABLE PROCTO-RECTOSCOPE TUBES 4844 WITH COLD-LIGHT ILLUMINATION

DISPOSABLE PROCTO/
RECTOSCOPE TUBES



	Ø	WL	Product no.
Rectoscopy tube Ø 21 mm WL 250 mm with obturator, graduated, sterile, disposable (PACK= 10 PCS)	21 mm	250 mm	4844255
Proctoscopy tube Ø 21 mm WL 117 mm with obturator, graduated, sterile, disposable (PACK= 10 PCS)	21 mm	117 mm	4844120
Procto-rectoscopy handle with cold-light illumination, reusable			8838.90
Sealing cap with observation window for handle 883890			8838.60
Hand blower with disposable filter, (sterile, PACK= 5 PCS)			412700

PROCTOSCOPE TUBES 8836

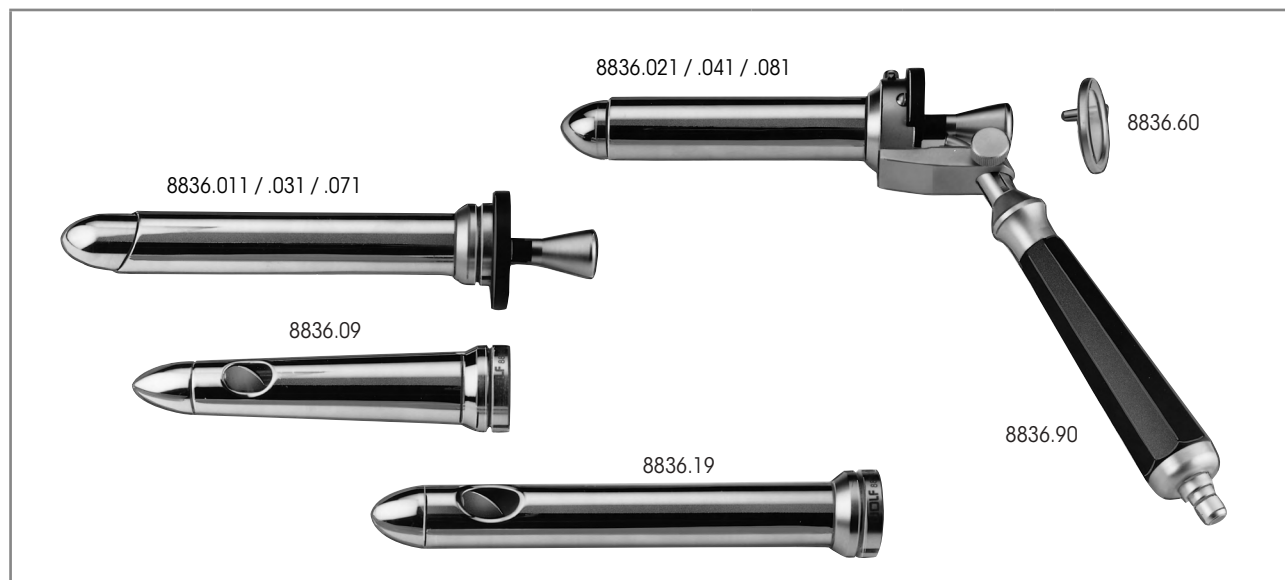

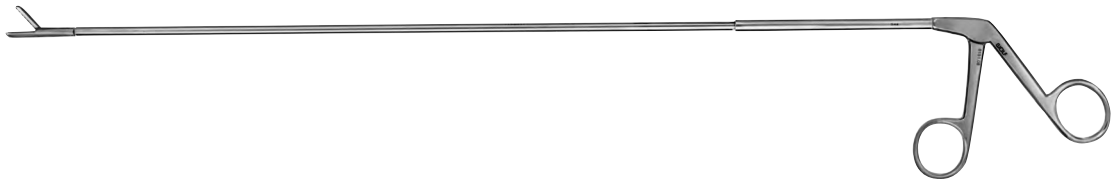

	Ø	WL	Product no.
Proctoscope handle with cold-light illumination and removable connection part			8836.90
Proctoscope tube bndl, straight, consisting of: Proctoscope tube Ø 21.5 mm WL 90 mm (8836.025), proctoscope obturator Ø 19 mm TL 156 mm (8836.027)	21 mm	90 mm	8836.021
Proctoscope tube bndl, oblique, consisting of: Proctoscope tube Ø 21.5 mm WL 120 mm (8836.015), proctoscope obturator Ø 19 mm TL 185 mm (8836.017)		120 mm	8836.011
Proctoscope tube bndl, straight, consisting of: Proctoscope tube bndl Ø 24 mm WL 60 mm (8836.085), proctoscope obturator Ø 22 mm TL 140 mm (8836.087)	24 mm	60 mm	8836.081
Proctoscope tube bndl, oblique, consisting of: Proctoscope tube Ø 24 mm WL 60 mm (8836.075), proctoscope obturator Ø 22 mm TL 140 mm (8836.077)			8836.071
Proctoscope tube bndl, straight, consisting of: Proctoscope tube Ø 18.5 mm WL 90 mm (8836.045), proctoscope obturator Ø 16 mm TL 154 mm (8836.047)	18 mm	90 mm	8836.041
Proctoscope tube bndl, oblique, consisting of: Proctoscope tube Ø 18.5 mm WL 120 mm (8836.035), proctoscope obturator Ø 16 mm TL 185 mm (8836.037)		120 mm	8836.031
Proctoscope tube Ø 18–24 mm WL 113 mm, TL 127 mm, conical with lateral window	Conical 18–24 mm	113 mm	8836.09
Proctoscope tube Ø 20 mm WL 148 mm TL 163 mm, cylindrical with lateral window	cylindrical 20 mm	148 mm	8836.19
Cover plate with observation window for handle 8836.90			8836.60

AUXILIARY INSTRUMENTS FOR PROCTOSCOPY

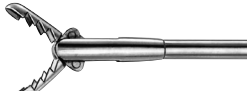
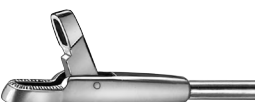

		Sheath Ø	Jaw section Ø	WL	Product no.
	Biopsy forceps WL 270 mm, smooth, jaw section straight, sheath straight	3 mm	4 mm	270 mm	8280.23
	Biopsy forceps WL 270 mm, serrated, jaw section straight, sheath straight	3 mm	4 mm	270 mm	8280.22
	Tumor forceps WL 270 mm, through-cutting, jaw section straight, sheath straight	3 mm	6 mm	270 mm	8280.26



		Sheath Ø	WL	Product no.
	Sponge forceps Ø 3.0 mm WL 300 mm	3 mm	300 mm	8148.02

ASPIRATION-LIGATURE INSTRUMENT FOR HAEMORRHOIDS

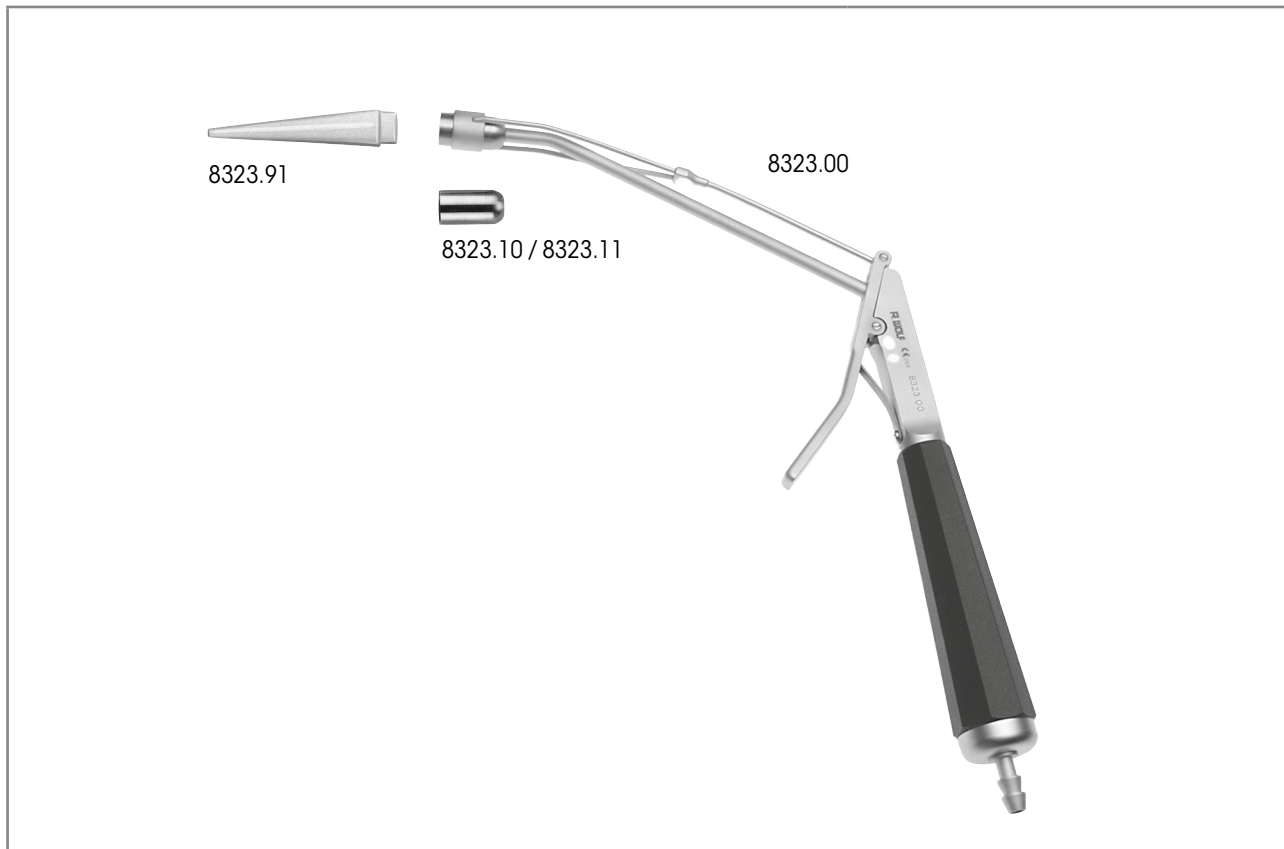

	WL	Product no.
Suction ligature instrument WL 145 mm	145 mm	8323.00
Suction head large		8323.10
Suction head small		8323.11
Loading cone WL 53 mm	53 mm	8323.91
For use through:		
Proctoscope handle with cold light illumination and removable connector		8836.90
Proctoscope tube bndl, oblique consisting of: Proctoscope tube Ø 24 mm WL 60 mm (8836.075), Proctoscope obturator Ø 22 mm TL 140 mm (8836.077)		8836.071

1123 || Subject to modifications. Please note that some products may not be available in all countries. Please always take note of the information that is provided with the product. For more detailed information, please consult with your contact partner or directly with Richard Wolf GmbH.

RECTOSCOPE TUBES 8834

WITH COLD-LIGHT ILLUMINATION

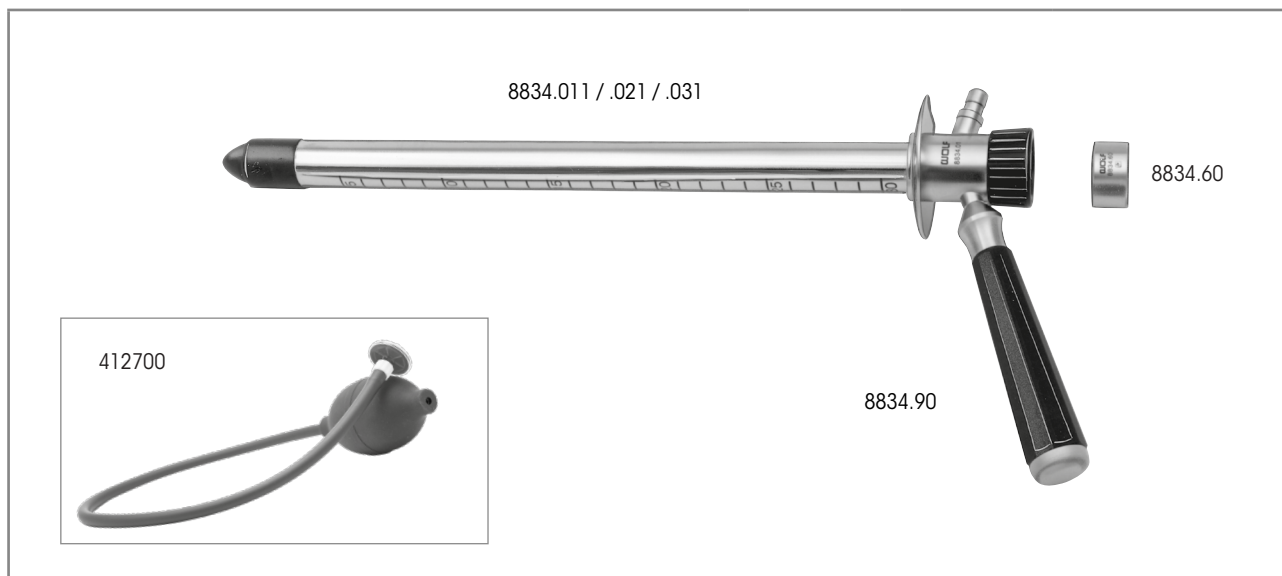

	Ø	WL	Product no.
Rectoscope handle with cold-light illumination, reusable			8834.90
Rectoscope tube bndl, consisting of: Rectoscope tube Ø 22 mm WL 310 mm (8834.015), rectoscope obturator Ø 18 mm TL 378 mm (8834.017)	22 mm	310 mm	8834.011
Rectoscope tube bndl, consisting of: Rectoscope tube Ø 22 mm WL 260 mm (8834.025), rectoscope obturator Ø 18 mm TL 328 mm (8834.027)	22 mm	260 mm	8834.021
Rectoscope tube bndl, consisting of: Rectoscope tube Ø 22 mm WL 210 mm (8834.035), rectoscope obturator Ø 18 mm TL 278 mm (8834.037)	22 mm	210 mm	8834.031
Sealing cap with observation window for handle 8834.90			8834.60
Hand blower with disposable filter, (sterile, PACK= 5 PCS)			412700

OPERATING RECTOSCOPE 8834

WITH COLD-LIGHT ILLUMINATION

OPERATING RECTOSCOPE

5

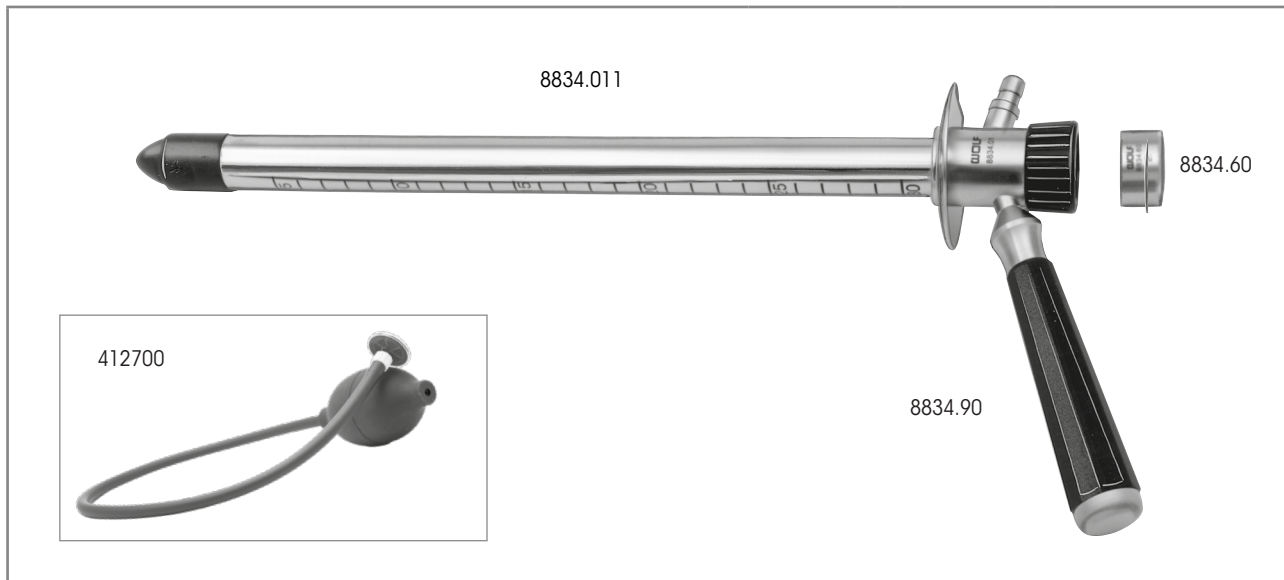

	Ø	WL	Product no.
Rectoscope handle with cold-light illumination, reusable			8834.90
Rectoscope tube bndl, consisting of: Rectoscope tube Ø 22 mm WL 310 mm (8834.015), rectoscope obturator Ø 18 mm TL 378 mm (8834.017)	22 mm	310 mm	8834.011
Sealing cap with observation window for handle 8834.90			8834.60
Hand blower with disposable filter, (sterile, PACK= 5 PCS)			412700

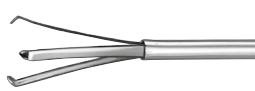

	Sheath Ø	WL	Product no.
 Sponge forceps Ø 3.0 mm WL 300 mm	3 mm	300 mm	8148.02

1123 || Subject to modifications. Please note that some products may not be available in all countries. Please always take note of the information that is provided with the product. For more detailed information, please consult with your contact partner or directly with Richard Wolf GmbH.

AUXILIARY INSTRUMENTS FOR RECTOSCOPY

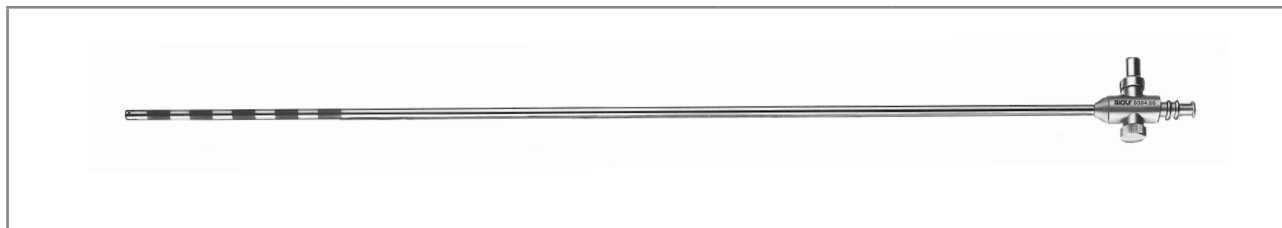

		Ø	WL	Product no.
	Suction tube OD 4.7 mm WL 450 mm, graduated with 3 mm Luer connector	4.7 mm	450 mm	8384.68



		Ø	WL	Product no.
	Sponge forceps Ø 5.0 mm WL 400 mm	5 mm	400 mm	8148.01

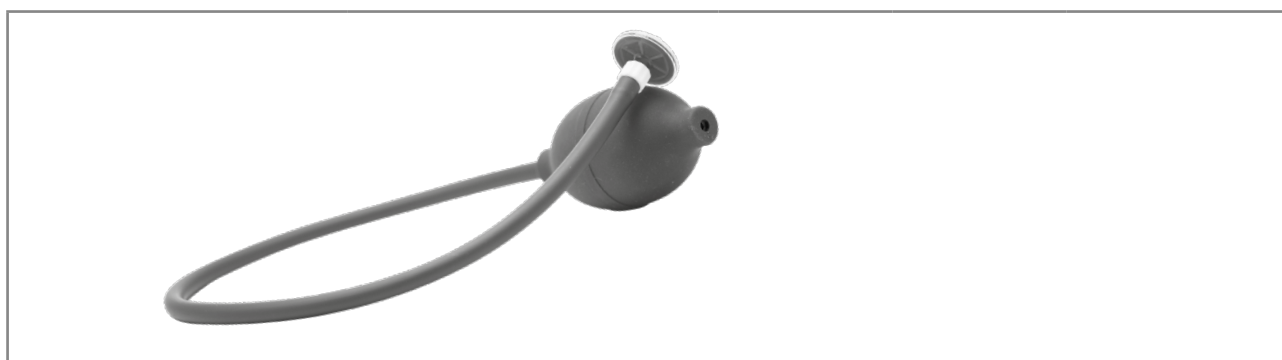

		Ø	TL	Product no.
	Hand blower with disposable filter, sterile (PACK= 5 PCS)	49 mm	567 mm	412700

1123 || Subject to modifications. Please note that some products may not be available in all countries. Please always take note of the information that is provided with the product. For more detailed information, please consult with your contact partner or directly with Richard Wolf GmbH.

ADDITIONS
FOR RECTOSCOPY

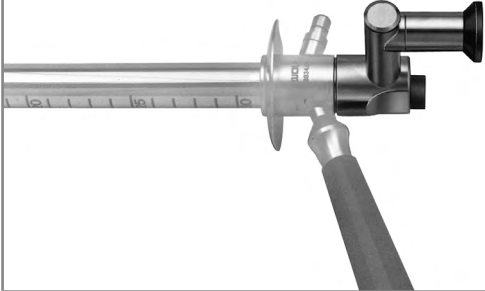
		Product no.
	<p>Operation connection capacity 6 mm with angled viewing, reusable</p>	<p>8834.25</p>

||23 || Subject to modifications. Please note that some products may not be available in all countries. Please always take note of the information that is provided with the product. For more detailed information, please consult with your contact partner or directly with Richard Wolf GmbH.

