



## Orthopedics

## Orthopedics

1

**Knee**

2

**Shoulder**

3

**Hip**

4

**Elbow / Foot**

5

**Hand / Fingers / Toes**

6

**FLUID MANAGEMENT Suction and Irrigation Pumps**

7

**Universal Motor Systems**

8

**Battery-powered tools bee-system II**

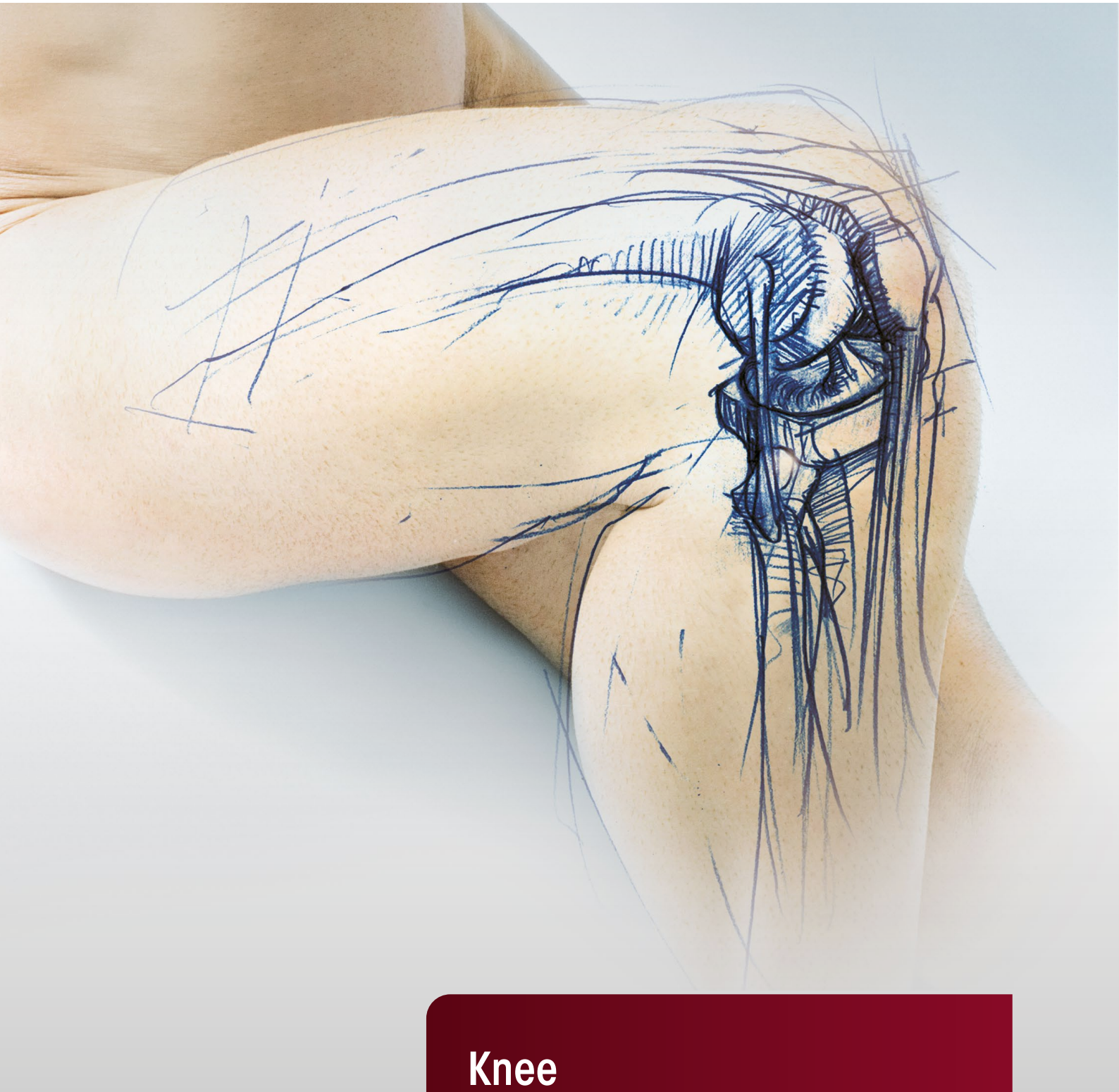

# Knee

## Knee

1.1

---

Standard Equipment

---

1.2

Meniscal and Soft Tissue Resection / Extraction

---

1.3

Meniscus Refixation

---

1.4

Treatment of Cartilage Defects

---

1.5

Cruciate Ligament Reconstruction

---

1.6

Leg Holders

---

## Basic Equipment

for diagnostic and operative arthroscopy

Product	Product no.	Quantity	Catalog / Section
<b>Endoscopes and Instruments</b>			
PANOVIEW telescope 30° Ø 4mm SL 170mm	8880.543	1	Orthopedics / Knee
Sheath for arthroscope OD 6mm	89121.1260	1	
Obturator for arthroscope OD 5.5/6/6.3mm	89121.0542	1	
Fiber light cable bndl, Ø 3.5 mm, 2.3 m long	806635231	1	
Hook probe WL 115mm H 4.5mm	8399.95	1	
ARTHROline punch W 4.6mm H 1.6mm, straight sheath	89140.0102	1	
ARTHROline punch W 5.5mm H 1.6mm, sheath curved to the left	89140.0101	1	
ARTHROline punch W 5.5mm H 1.6mm, sheath curved to the right	89140.0103	1	
ARTHROline hook punch W 3mm H 1.6mm, straight sheath	89140.0202	1	
Grasping forceps Ø 3.4mm	8488.096	1	
Meniscus grasping forceps Ø 4/7mm	8403.001	1	
<b>Treatment of Cartilage Defects – Microfracture</b>			
Curette, round, Ø 4.5mm WL 95mm	8435.902	1	Orthopedics / Knee
Curette, round, Ø 6mm WL 95mm	8435.903	1	
Microfractor WL 110mm 15°, curved	8435.951	1	
Microfractor WL 110mm 30°, curved	8435.963	1	
Microfractor WL 110mm 45°, curved	8435.952	1	
Microfractor WL 110mm 35°, curved	8435.953	1	
Microfractor WL 110mm 60°, curved	8435.956	1	
Microfractor WL 110mm 60°, curved	8435.966	1	
Microfractor WL 110mm 80°, curved	8435.968	1	
<b>Shaver Set</b>			
PowerSpeed AS1 MOTOR CONTROL UNIT 2305	2305001	1	Orthopedics / Motor System
Remote footswitch 2 pedals+2 buttons	2305100	1	
Motor handpiece max. 1.6000rpm	8995500031	1	
Resector toothed Ø 4.5mm	89975.0034	1	
Resector oval, Ø 4.5mm	89975.0114	1	
Resector aggress Ø 4.7mm	89975.0334	1	
Acromionizer Ø 5.5mm	89975.0555	1	
<b>Fluid Management</b>			
FLUID CONTROL arthro/spine suc./irrig.pump bndl	22040011	1	Orthopedics / FLUID CONTROL Suction irrigation pump
Irrigation tube set spike L 3m	4171223	1	
<b>Imaging</b>			
ENDOCAM Logic HD Camera Controller bndl	55251051	1	Imaging / ENDOCAM
ENDOCAM Logic HD camera head cable 3 m	85525922	1	
RIWO zoom lens F 13–29mm	85261504	1	
Light source LED 2.2 bndl	51640011	1	Imaging / Light Sources
Light source LED 1.1 bndl	51600011	1	
LCD monitor 27" 4K	LMD-X2705N	1	Imaging / Monitors
Monitor mount VESA 75/100	321165001	1	Imaging / Device Carts

Overview

arthro <sup>lution</sup>		Fingers, toes	Hand	Foot, elbow		Knee, shoulder, hip	
Telescope Ø		1.9 mm	2.4 mm	2.7 mm		4.0 mm	
Telescopes	30°	PANOVIEW telescope	<b>8860453</b>	<b>8871413</b>	<b>8476.433</b>	<b>8672.422</b>	<b>8880.543</b>
		PANOVIEW wide angle telescope					<b>8885.443</b>
	70°	PANOVIEW telescope					<b>8880.545</b>
		PANOVIEW wide angle telescope					<b>8885.445</b>
Sheath WL		40 mm	60 mm	77.5 mm	145 mm	130 mm	
Sheaths	with 1 irrigation stopcock, fixed		<b>891220124</b>	<b>891220132</b>			
	with 2 irrigation stopcocks, fixed						<b>89121.0260</b>
	with 1 irrigation stopcock, rotatable					<b>891241141</b>	
	with 2 irrigation stopcocks, rotatable			<b>891221232</b>	<b>891221241</b>	<b>891241241</b>	<b>89121.1260</b>
	High-Flow with 1 irrigation stopcock, fixed		<b>891220128</b>				
	High-Flow with 2 irrigation stopcocks, rotatable			<b>891221235</b>			<b>89121.1263</b>
	Small-caliber with 2 irrigation stopcocks, rotatable						<b>891221255</b>
Obturator	blunt				<b>891222754</b>		<b>89121.0544</b>
	semi-blunt		<b>891221952</b>	<b>891222452</b>			<b>89121.0542</b>
	conical blunt				<b>891222750</b>	<b>891242750</b>	<b>89121.0540</b>
	sharp					<b>891242761</b>	<b>89121.0640</b>
	conical pointed		<b>891221962</b>	<b>891222462</b>	<b>891222762</b>		
Sealing part for sheath					<b>891040000</b>		

|| Subject to modifications. Please note that some products may not be available in all countries. For more detailed information, please consult with your contact partner or directly with Richard Wolf GmbH.

|| Subject to modifications. Please note that some products may not be available in all countries. For more detailed information, please consult with your contact partner or directly with Richard Wolf GmbH.

Arthroscope  
with PANOVIEW Telescope Ø 4 mm

Direction of view	PANOVIEW telescope	SL	Ø	Product no.
0°	PANOVIEW telescope 0° Ø 4mm SL 170mm	170 mm	4.0 mm	<b>8880.541</b>
30°	PANOVIEW telescope 30° Ø 4mm SL 170mm			<b>8880.543</b>
45°	PANOVIEW telescope 45° Ø 4mm SL 170mm			<b>8880.544</b>
70°	PANOVIEW telescope 70° Ø 4mm SL 176mm			176 mm

**AUTOCLAVE**  
**134° C / 273° F**

Recommended accessories		Product no.
Perf. basket for standard telescope 1	(L x B x H) 297 x 59 x 54 mm	<b>38015</b>
Fiber light cable bndl Comprising: Fiber light cable (80663523), adapter projector side (8095.07) and adapter endoscope side (809509)	Ø 3.5 mm, 2.3 m long	<b>806635231</b>

## Arthroscope with PANOVIEW Wide Angle Telescope

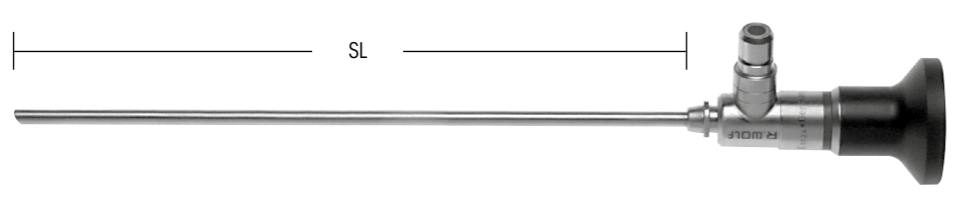

**AUTOCLAVE**  
**134° C / 273° F**

Direction of view		SL	Ø	Product no.
0°	PANOVIEW Wide angle telescope 0° Ø 4mm SL 171mm	171 mm	4.0 mm	<b>8885.441</b>
30°	PANOVIEW Wide angle telescope 30° Ø 4mm SL 170mm	170 mm		<b>8885.443</b>
70°	PANOVIEW Wide angle telescope 70° Ø 4mm SL 176mm	176 mm		<b>8885.445</b>

Recommended accessories		Product no.
Perf. basket for standard telescope 1	(L x B x H) 297 x 59 x 54 mm	<b>38015</b>
Fiber light cable bndl Comprising: Fiber light cable (80663523), adapter projector side (8095.07) and adapter endoscope side (809509)	Ø 3.5 mm, 2.3 m long	<b>806635231</b>

|| Subject to modifications. Please note that some products may not be available in all countries. For more detailed information, please consult with your contact partner or directly with Richard Wolf GmbH.

|| Subject to modifications. Please note that some products may not be available in all countries. For more detailed information, please consult with your contact partner or directly with Richard Wolf GmbH.

## arthro<sup>lution</sup> Sheath for Arthroscope

with automatic click-lock mechanism

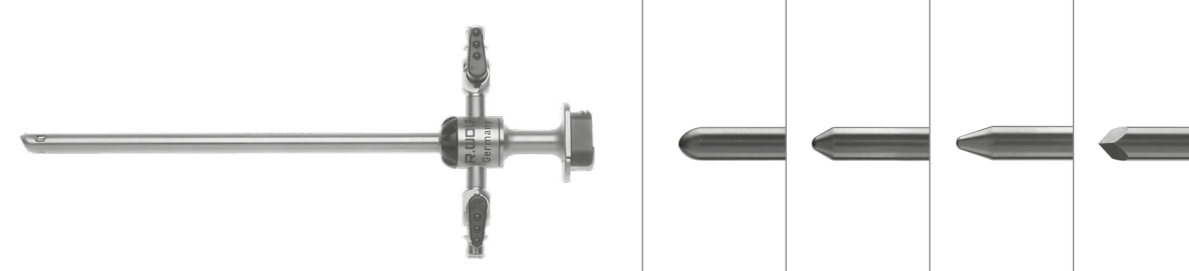

Sheath for arthroscope OD 6mm							Obturator for arthroscope 5.5/6/6.3mm blunt	Obturator for arthroscope 5.5/6/6.3mm semi-blunt	Obturator for arthroscope 5.5/6/6.3mm conical blunt	Trocar tip, triangular SZ 4mm WL 176mm
High-Flow	Small-caliber	2 fixed stopcocks	2 rotatable stopcocks	Outer Ø	WL	Product no.				
		•		6.0 mm	132 mm	<b>89121.0260</b>	89121.0544	89121.0542	89121.0540	89121.0640
			•	6.0 mm	130 mm	<b>89121.1260</b>				
•			•	6.3 mm	130 mm	<b>89121.1263</b>				
	•		•	5.5 mm	130 mm	<b>891221255</b>				

Spare parts	Product no.
Irrigation ring with 1 stopcock	<b>150081761</b>
Irrigation ring with 2 stopcocks	<b>150081762</b>
Stopcock insert, bundle, cap 3.0mm (PACK= 5 PCS) Also: Disassembly tool	<b>896.0002</b> <b>38310.0001</b>
Mounting ring	<b>15008.1704</b>
Spare sealing comprising: O-rings, small / large, 5 of each Also: O-ring tool (disassembly tool)	<b>15176.142</b> <b>15106.230</b>

Recommended accessories	Product no.
Sealing part for sheath	<b>89101.0000</b>
Marking rod Ø 4.0mm conical blunt TL 325 mm	<b>8863.75</b>

## Drainage Cannula Ø 2.3 mm / 3.7 mm

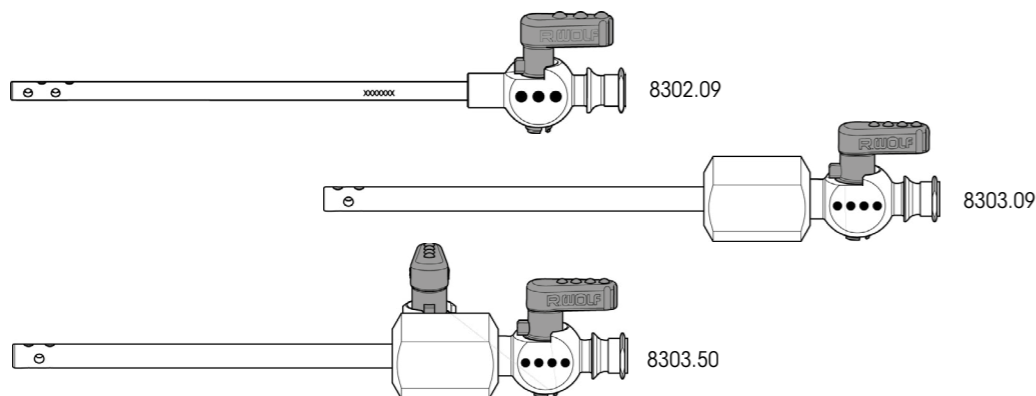

Drainage for cannula and obturator	Capacity	Ø	WL	Product no.
<b>Drainage for cannula Ø 3.2 mm WL 80 mm</b> with 1 insufflation stopcock	2.3 mm	3.2 mm	80 mm	<b>8302.09</b>
<b>Drainage for cannula Ø 4.5 mm WL 71.5 mm</b> with 1 insufflation stopcock	3.7 mm	4.5 mm	71.5 mm	<b>8303.09</b>
<b>Drainage for cannula Ø 4.5 mm WL 71.5 mm</b> with 2 insufflation stopcocks	3.7 mm	4.5 mm	71.5 mm	<b>8303.50</b>
<b>Obturator for cannula OD 3.2 mm</b> sharp, with slanted tip		2.3 mm	103 mm	<b>8302.101</b>
<b>Obturator for cannula OD 3.2 mm</b> conical blunt tip		2.3 mm	103 mm	<b>8302.11</b>
<b>Obturator for cannula OD 4.5 mm</b> sharp, with pyramid-shaped tip		4.5 mm	115 mm	<b>8303.10</b>
<b>Obturator for cannula OD 4.4 mm</b> conical blunt tip		4.4 mm	115 mm	<b>8303.11</b>
Also:				
<b>Silicone tube</b> with Luer fitting 886.00	for Drainage for cannula 8302.09	Length 2.0 m		<b>8302.90</b>
<b>Silicone tube</b> with Luer fitting 886.01	for Drainage for cannula 8303.09 / .50			<b>8303.90</b>

|| Subject to modifications. Please note that some products may not be available in all countries. For more detailed information, please consult with your contact partner or directly with Richard Wolf GmbH.

|| Subject to modifications. Please note that some products may not be available in all countries. For more detailed information, please consult with your contact partner or directly with Richard Wolf GmbH.

## Hook Probe / Marking Rod



	H	WL	Product no.
<b>Hook probe WL 115mm H 7mm,</b> graduated	7.0 mm	115 mm	<b>8399.901</b>
<b>Hook probe WL 115mm H 4.5mm,</b> graduated	4.5 mm		<b>8399.95</b>



	Ø	TL	Product no.
<b>Hook probe TL 228 mm SZ 4.4mm</b>	4.4 mm	228 mm	<b>8863.80</b>







	Ø	TL	Product no.
<b>Marking rod Ø 4.0mm</b> conical blunt	4.0 mm	325 mm	<b>8863.75</b>



Versions







Version		Use
	<b>Straight</b>	For direct access
	<b>Jaws curved 15° upward</b>	Facilitates use, e.g., around the posterior horn
	<b>Sheath curved 15° upward</b>	Tailored to the anatomy of the condyles
	<b>Curved to the left</b>	Better access to the anterior and posterior meniscus
	<b>Curved to the right</b>	

VI121 || Subject to modifications. Please note that some products may not be available in all countries. For more detailed information, please consult with your contact partner or directly with Richard Wolf GmbH.

VI121 || Subject to modifications. Please note that some products may not be available in all countries. For more detailed information, please consult with your contact partner or directly with Richard Wolf GmbH.

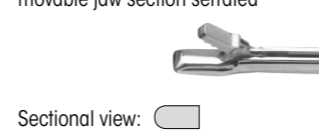

Push control rod can be opened up for cleaning, disinfection, and sterilization

ARTHROline	Jaw section (Height x width)	Cut width	WL	Straight	Curved to the right	Curved to the left	Sheath curved upward	Jaw section curved upward	Product no.		
<b>Punch W 4.6mm H 1.6mm</b> movable jaw section serrated 	1.6 x 4.6 mm	3.3 mm	120 mm	•					<b>89140.0105</b>		
<b>Punch W 4.6mm H 1.6mm</b> movable jaw section serrated 										•	<b>89140.0102</b>
<b>Punch W 4. mm H 1.6mm</b> movable jaw section serrated 	1.6 x 5.5 mm	3.3 mm	120 mm				•		<b>89140.0122</b>		
<b>Punch W 5.5mm H 1.6mm</b> movable jaw section serrated 								•		•	<b>89140.0101</b>
<b>Punch W 5.5mm H 1.6mm</b> movable jaw section serrated 								•		•	<b>89140.0103</b>

VI121 || Subject to modifications. Please note that some products may not be available in all countries. For more detailed information, please consult with your contact partner or directly with Richard Wolf GmbH.

VI121 || Subject to modifications. Please note that some products may not be available in all countries. For more detailed information, please consult with your contact partner or directly with Richard Wolf GmbH.

arthroline Hook Punch / Basket Punch



ARTHROline	Jaw section (Height x width)	Cut width	WL	Straight	Jaw section curved upward	Product no.
Hook punch W 3mm H 1.6mm Sectional view:	1.6 x 3.0 mm	1.8 mm	120 mm	•		89140.0205
Hook punch W 3mm H 1.6mm Sectional view:					•	89140.0202
Basket punch W 6.5mm H 2.1mm oval Sectional view:	2.1 x 6.5 mm	4.5 mm		•		89140.0305
Basket punch W 6.5mm H 2.1mm oval Sectional view:					•	89140.0302
Hook punch W 4mm H 2.1mm Sectional view:	2.1 x 4.0 mm	2.1 mm		•		89140.0405
Hook punch W 4 mm H 2.1mm Sectional view:					•	89140.0402

VI121 || Subject to modifications. Please note that some products may not be available in all countries. For more detailed information, please consult with your contact partner or directly with Richard Wolf GmbH.

VI121 || Subject to modifications. Please note that some products may not be available in all countries. For more detailed information, please consult with your contact partner or directly with Richard Wolf GmbH.

arthroline Punch / Scissors Punch



ARTHROline	Jaw section (Height x width)	Cut width	WL	Straight	Retrograde cutting	Jaw section curved upward	Product no.
Scissors punch W 2.4mm H 2.1mm Sectional view:	2.1 x 2.4 mm	0.9 mm	120 mm	•			89140.0505
Scissors punch W 2.4mm H 2.1mm Sectional view:						•	
Punch W 5.7mm H 4mm retrograde left-cutting Sectional view:	4.0 x 5.7 mm	2.3 mm		•	left		89140.0605
Punch W 5.7mm H 4mm retrograde right-cutting Sectional view:						•	right

VI121 || Subject to modifications. Please note that some products may not be available in all countries. For more detailed information, please consult with your contact partner or directly with Richard Wolf GmbH.

VI121 || Subject to modifications. Please note that some products may not be available in all countries. For more detailed information, please consult with your contact partner or directly with Richard Wolf GmbH.

## Suction Punch / Suction Grasping Forceps with Integrated Suction Channel



With integrated suction channel	Ø	WL	Product no.
Suction punch Ø 2.7mm can be dismantled	2.7 mm	110 mm	89140.0027
Suction punch Ø 4.5mm can be dismantled	4.5 mm		89140.0045

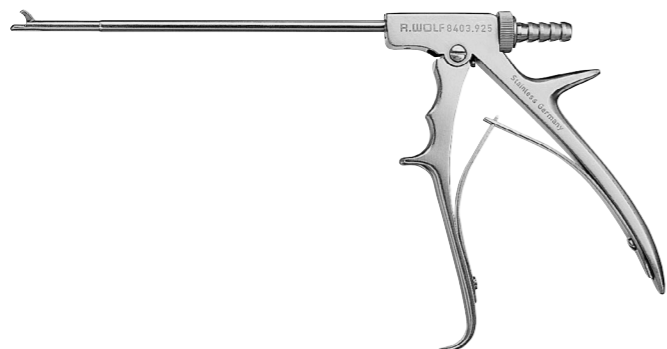









With integrated suction channel	Sheath Ø	WL	Product no.
Suction punch Ø 4.5mm straight	4.5 mm	130 mm	8403.925
Suction grasping forceps straight			8403.851

|| Subject to modifications. Please note that some products may not be available in all countries. For more detailed information, please consult with your contact partner or directly with Richard Wolf GmbH.

|| Subject to modifications. Please note that some products may not be available in all countries. For more detailed information, please consult with your contact partner or directly with Richard Wolf GmbH.



## Hook Punch / Punch

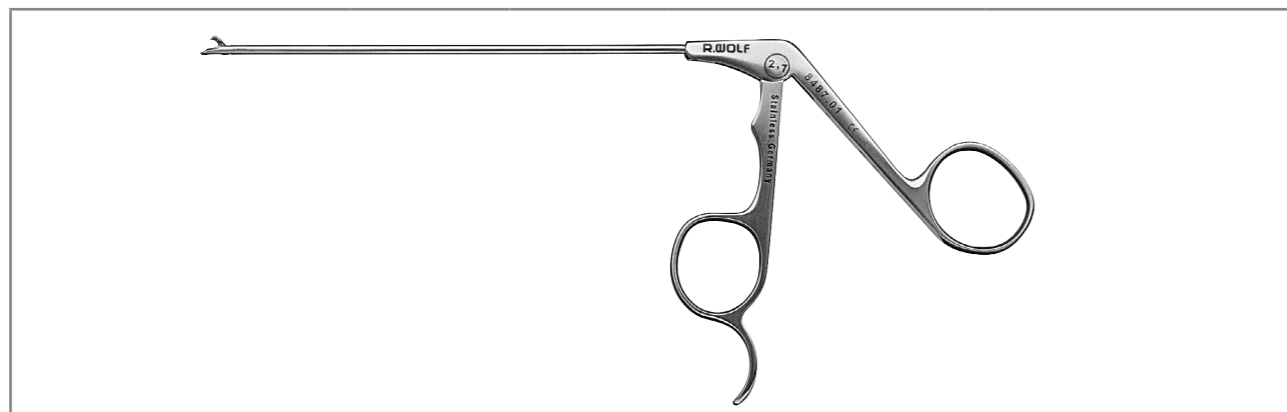

	Jaw section (Height x width)	Cut width	WL	Straight	Curved to the left	Curved to the right	Sheath curved 15° upward	Jaw section curved upward	Product no.		
Hook punch Ø 3.4mm with shovel	3.4 x 3.4 mm	1.6 mm	130 mm	•					8488.951		
					•					8488.952	
Sectional view: 								•			8488.953
									•	•	8488.954
Hook punch Ø 3.4mm					•				8488.02		
								•	8488.025		
Sectional view: 											
Hook punch Ø 3.4mm serrated		2.7 mm			•				8488.121		
	1.93 x 3.9 mm						•	8488.063			
Sectional view: 											
Hook punch Ø 4.5mm with shovel, serrated		3.4 mm						•	8489.063		
	1.73 x 5.4 mm										
Sectional view: 											

Punch



	Jaw section (Height x width)	Jaw section deflection	Cut width	WL	Product no.
<b>Punch Ø 3.4mm</b> front- and side-cutting   Sectional view: <input type="checkbox"/>	2.2 x 5.3 mm	90° left	3.4 mm	130 mm	<b>8404.017</b>
		90° right			<b>8404.018</b>
<b>Hook punch with shovel Ø 3.4mm</b>   Sectional view: <input type="checkbox"/>	2.1 x 2.0 mm	45° left	1.7 mm		<b>8404.71*</b>
		45° right			<b>8404.81*</b>



\* particularly suitable for lateral cutting and smoothing

VI121 || Subject to modifications. Please note that some products may not be available in all countries. For more detailed information, please consult with your contact partner or directly with Richard Wolf GmbH.

VI121 || Subject to modifications. Please note that some products may not be available in all countries. For more detailed information, please consult with your contact partner or directly with Richard Wolf GmbH.

Scissors



	WL	Straight jaw section	Straight sheath	Sheath curved to the left	Sheath curved to the right	Product no.
<b>Hook scissors Ø 3.4mm</b>   Sectional view: <input type="checkbox"/>	130 mm	<input type="checkbox"/>	<input type="checkbox"/>	<input type="checkbox"/>	<input type="checkbox"/>	<b>8488.04</b>
		<input type="checkbox"/>	<input type="checkbox"/>	<input checked="" type="checkbox"/>	<input type="checkbox"/>	<b>8488.041</b>
		<input type="checkbox"/>	<input type="checkbox"/>	<input type="checkbox"/>	<input checked="" type="checkbox"/>	<b>8488.042</b>
 Sectional view: <input type="checkbox"/>	130 mm	<input type="checkbox"/>	<input type="checkbox"/>	<input checked="" type="checkbox"/>	<input type="checkbox"/>	<b>8488.052</b>
		<input type="checkbox"/>	<input type="checkbox"/>	<input type="checkbox"/>	<input checked="" type="checkbox"/>	<b>8488.053</b>
		<input type="checkbox"/>	<input type="checkbox"/>	<input type="checkbox"/>	<input type="checkbox"/>	<input checked="" type="checkbox"/>
	WL	Jaw section deflection	Straight sheath		Product no.	
	130 mm	45° right	<input checked="" type="checkbox"/>		<b>8404.62</b>	

Forceps

Suture Grasping Forceps / Meniscus Grasping Forceps

Knee  
1.2

Knee  
1.2

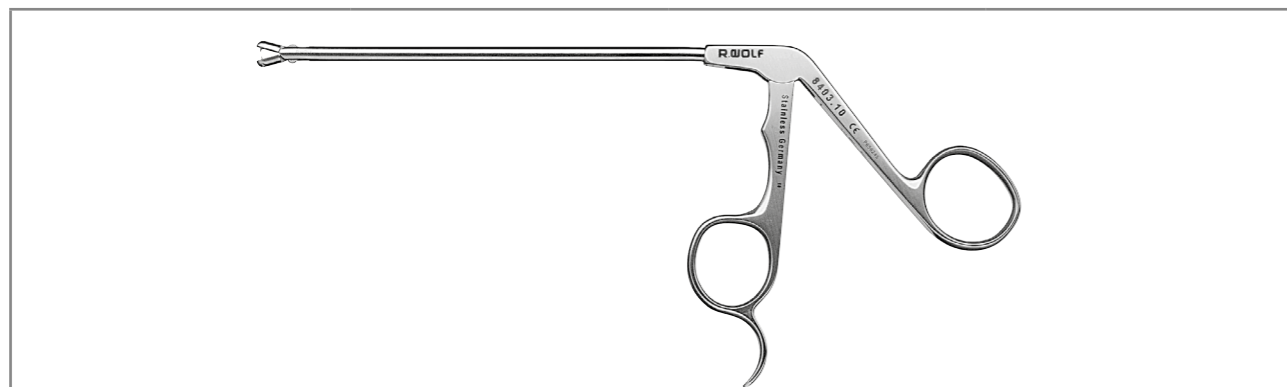

For retraction	Ø	WL	Product no.
<b>Biopsy forceps with spike</b> Ø 4.5mm smooth, double-action	4.5 mm	130 mm	<b>8403.10</b>

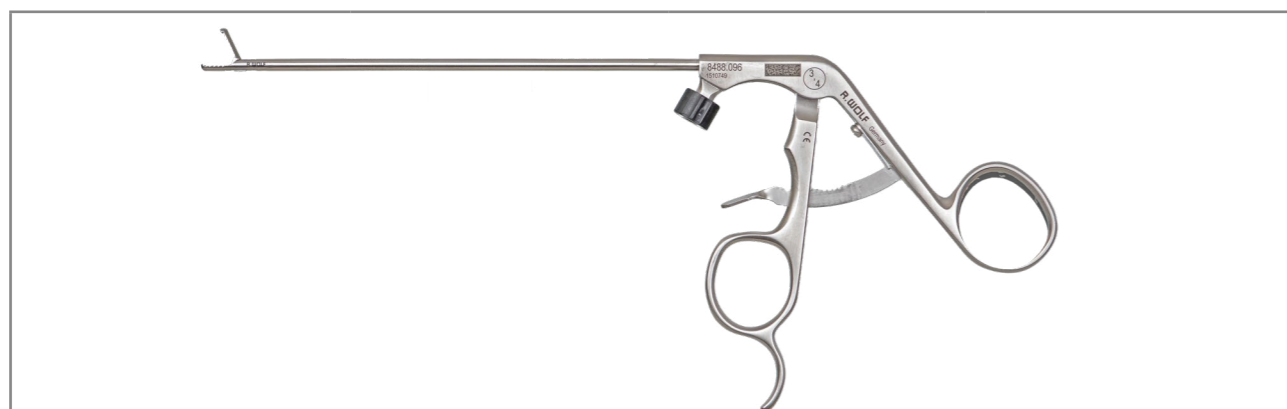

Handle with lock	Ø	WL	Product no.
<b>Grasping forceps Ø 3.4mm</b> straight jaw section, serrated	3.4 mm	130 mm	<b>8488.096</b>
<b>Grasping forceps Ø 4.5mm</b> straight jaw section, serrated	4.5 mm	134 mm	<b>8489.096</b>

VI121 || Subject to modifications. Please note that some products may not be available in all countries. For more detailed information, please consult with your contact partner or directly with Richard Wolf GmbH.

VI121 || Subject to modifications. Please note that some products may not be available in all countries. For more detailed information, please consult with your contact partner or directly with Richard Wolf GmbH.

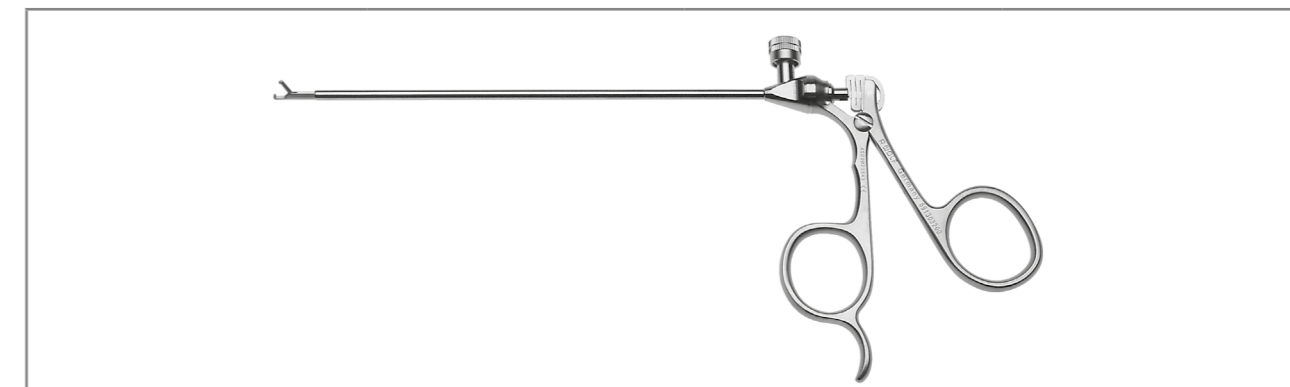



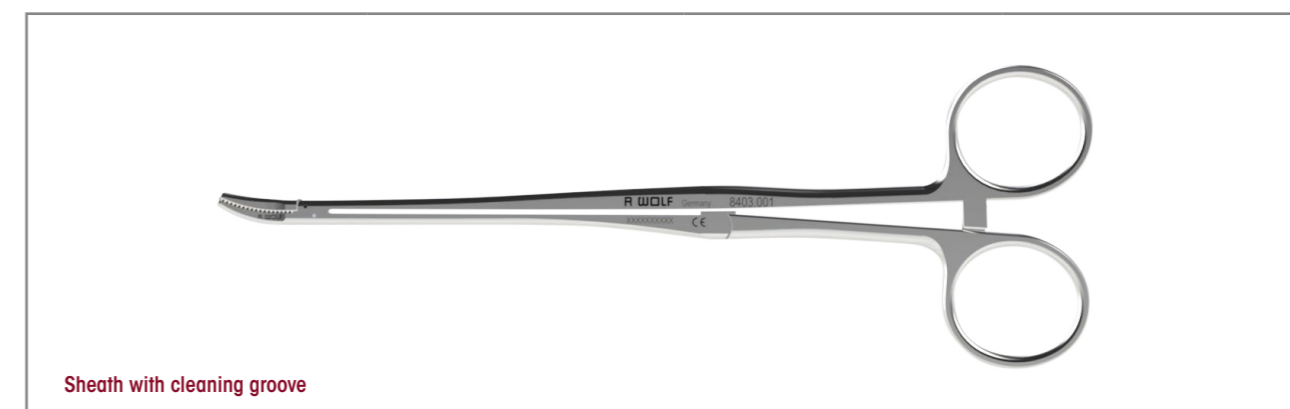

	Ø	WL	Product no.
<b>Suture grasping forceps Ø 3.3mm</b> Straight	3.3 mm	160 mm	<b>891303300</b>



Sheath with cleaning groove	Ø	WL	Product no.
<b>Meniscus grasping forceps</b> Ø 4/7mm with gripping tooth	4 / 7 mm	105 mm	<b>8403.00</b>
<b>Meniscus grasping forceps</b> Ø 4/7 mm			<b>8403.001</b>





Scalpel / Knife

	WL	Product no.
		
<b>Straight scalpel WL 125mm</b>		<b>8436.101</b>
		
<b>Rosette knife WL 125mm</b>		<b>8436.151</b>
		
<b>Hook knife WL 125mm</b>	125 mm	<b>8436.201</b>
		
<b>Banana knife WL 125mm</b>		<b>8436.251</b>
		
<b>Straight arthro knife WL 125mm</b>		<b>8436.301</b>

|| Subject to modifications. Please note that some products may not be available in all countries. For more detailed information, please consult with your contact partner or directly with Richard Wolf GmbH.

|| Subject to modifications. Please note that some products may not be available in all countries. For more detailed information, please consult with your contact partner or directly with Richard Wolf GmbH.

Hand Instruments  
Curette

	Ø	WL	Product no.
			
<b>Curette square Ø 4.5mm WL 170mm</b>	4.5 mm		<b>891632245</b>
double-blade and curved upward			
			
<b>Curette square Ø 5mm WL 170mm</b>	5.0 mm		<b>891632260</b>
double-blade and curved upward			
			
<b>Curette round Ø 4.8mm WL 170mm</b>	4.8 mm	170 mm	<b>891631255</b>
double-blade and curved upward			
			
<b>Curette round Ø 6.3mm WL 170mm</b>	6.3 mm		<b>891631270</b>
double-blade and curved upward			

Hand Instruments  
Curette



	Inner Ø	WL	Product no.
<b>Curette, round Ø 3mm WL 95mm</b> sharp at one end, curved upward, forward cutting	3.0 mm	95 mm	<b>8435.901</b>
<b>Curette, round Ø 4.5mm WL 95mm</b> sharp at one end, curved upward, forward cutting	4.5 mm		<b>8435.902</b>
<b>Curette, round Ø 6mm WL 95mm</b> sharp at one end, and curved upward, forward cutting	6.0 mm		<b>8435.903</b>
<b>Curette, round Ø 9mm WL 95mm</b> sharp at one end, and curved upward, forward cutting	9.0 mm		<b>89160.1009</b>

|| Subject to modifications. Please note that some products may not be available in all countries. For more detailed information, please consult with your contact partner or directly with Richard Wolf GmbH.

|| Subject to modifications. Please note that some products may not be available in all countries. For more detailed information, please consult with your contact partner or directly with Richard Wolf GmbH.

Hand Instruments  
Microfractor



	Deflection	WL	Product no.
<b>Microfractor WL 65mm 30°</b>	Curved 30°	65 mm	<b>891643011</b>
<b>Microfractor WL 65mm 45°</b>	Curved 45°		<b>891644511</b>
<b>Microfractor WL 65mm 60°</b>	Curved 60°		<b>891646011</b>

|| Subject to modifications. Please note that some products may not be available in all countries. For more detailed information, please consult with your contact partner or directly with Richard Wolf GmbH.

|| Subject to modifications. Please note that some products may not be available in all countries. For more detailed information, please consult with your contact partner or directly with Richard Wolf GmbH.

Hand Instruments  
Microfractor



	Deflection	WL	Product no.
Mikrofractor WL 110mm 15°	15° curved	110 mm	<b>8435.951</b>
Mikrofractor WL 10mm 30°	30° curved		<b>8435.963</b>
Mikrofractor WL 110mm 35°	35° curved		<b>8435.953</b>
Mikrofractor WL 110mm 60°	60° curved		<b>8435.956</b>
Mikrofractor WL 110mm 60°	60° curved		<b>8435.966</b>
Mikrofractor WL 110mm 80°	80° curved		<b>8435.968</b>



	Deflection	WL	Product no.
Mikrofractor WL 110mm 45°	45° curved	110 mm	<b>8435.952</b>

|| Subject to modifications. Please note that some products may not be available in all countries. For more detailed information, please consult with your contact partner or directly with Richard Wolf GmbH.

|| Subject to modifications. Please note that some products may not be available in all countries. For more detailed information, please consult with your contact partner or directly with Richard Wolf GmbH.

Hand Instruments  
Cartilage File, Spoon, Curette  
ACL Hammer



	Version	WL	Product no.
Cartilage file straight WL 125mm W 6.25mm rough	Straight	125 mm	<b>8436.501</b>
Cartilage file convex WL 125mm W 6.25mm rough	Convex		<b>8436.511</b>
Cartilage file concave WL 125mm W 6.25mm W 6.25 mm, rough	Concave		<b>8436.521</b>
Spoon Ø 6.5 x 10mm WL 125mm rough	Curved		<b>8436.601</b>
Curette round Ø 5mm WL 125mm double-blade	Angled		<b>8436.701</b>



	TL	Product no.
ACL hammer TL 248mm	248 mm	<b>8866.956</b>





**Modular concept**

The system's outstanding performance is provided by its unparalleled diversity and universality. **Graftline** offers highly specialized – and in some cases patented – technology for a huge range of surgical options.

- **Efficiency goes hand in hand.** Minimal handles and intuitive connection options for all instruments save on space and weight.
- **ACL and PCL in one instrument.** **Graftline** provides the instruments for anterior and posterior cruciate ligament plastic surgery in intelligent combinations.
- **Well prepared for optimum grip.** With the Graftline instruments and implants, the surgeon is perfectly prepared for all eventualities, for example, if reruptures occur.

**A choice of fixing options**

**Graftline** allows the ideal fixation method to be selected for the cruciate ligament graft, without the need for major adjustments. We offer a tried-and-tested range of fixing implants.

**Unique perspectives**

**Graftline** gives surgeons access to all methodological channels – from standard techniques to innovative specific solutions. BTB, BT grafts, hamstrings, allografts, oval tunnel technique, and hollow-burr technique: one system – a wealth of possibilities.

V1121 || Subject to modifications. Please note that some products may not be available in all countries. For more detailed information, please consult with your contact partner or directly with Richard Wolf GmbH.

V1121 || Subject to modifications. Please note that some products may not be available in all countries. For more detailed information, please consult with your contact partner or directly with Richard Wolf GmbH.

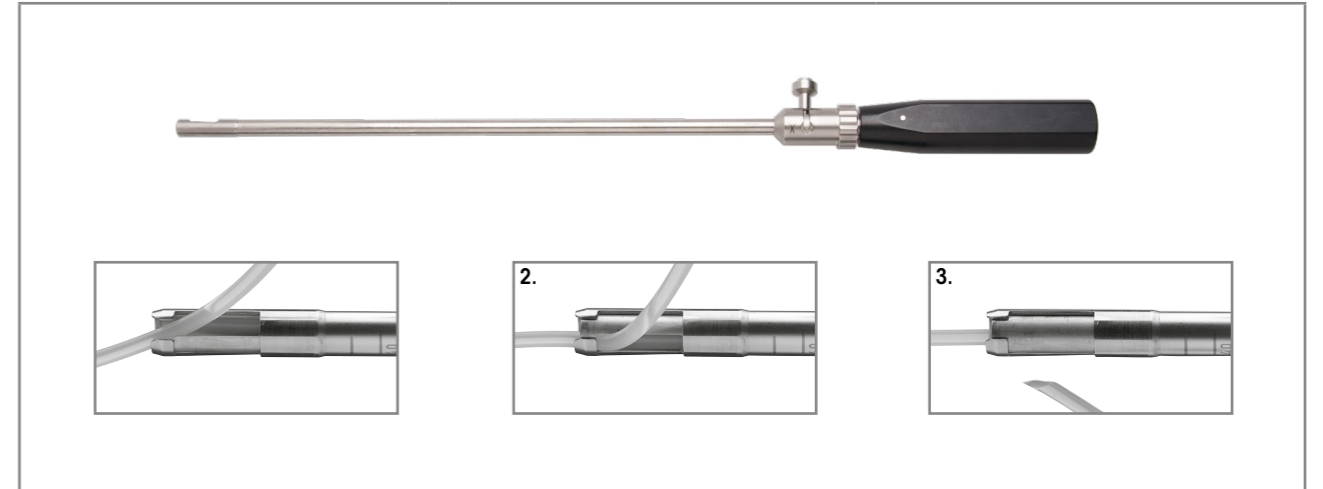

		1. Retract	2. Secure	3. Sever		
				Ring Ø	WL	Product no.
 <b>Tendon stripper, universal</b> 300mm, SZ8 mm  by Pässler	<ul style="list-style-type: none"> <li>● Universal use: open / closable / cutting function</li> <li>● Blunt distal end</li> <li>● Can be disassembled</li> </ul>			8.0 mm	300 mm	<b>8866.951</b>

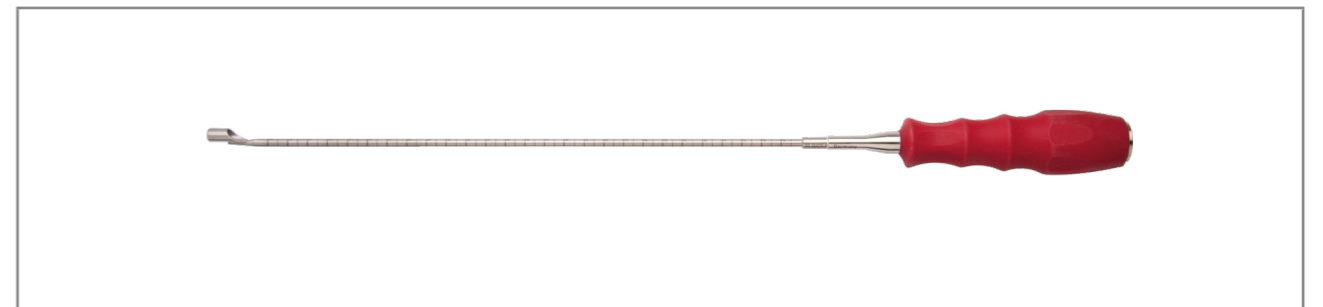

		Ring Ø	WL	Product no.
 <b>Tendon stripper, standard</b> 300 mm, size 7 mm	<ul style="list-style-type: none"> <li>● Closed</li> <li>● Sharp distal end</li> </ul>	8.0 mm	300 mm	<b>891610070</b>



		Inner Ø	Outer Ø	WL	Product no.
Hollow burr SZ 8	<ul style="list-style-type: none"> <li>For efficient removal of the bone blocks for BT or BTB transplants when using the quadriceps or patellar tendon</li> <li>For application with the bee-system II oscillating ream machine F-31-700-00</li> </ul>	8,4 mm	9,4 mm	90 mm	<b>8869.841</b>
Hollow burr SZ 9		9,4 mm	10,4 mm		<b>8869.843</b>
Hollow burr SZ 10		10,4 mm	11,4 mm		<b>8869.844</b>



		Inner Ø	Outer Ø	WL	Product no.
Hollow drill bit SZ 8	<ul style="list-style-type: none"> <li>For application with the bee-system II oscillating ream machine F-31-700-00</li> </ul>	7,4 mm	8,5 mm	185 mm	<b>8869849</b>
Hollow drill bit SZ 9		8,4 mm	9,5 mm		<b>8869.851</b>
Hollow drill bit SZ10		9,4 mm	10,5 mm		<b>8869.852</b>



		Inner Ø	Outer Ø	WL	Product no.
Bone elevator SZ 8	<ul style="list-style-type: none"> <li>Harvesting the bone blocks from the patella after using hollow burrs</li> <li>Different diameters to remove the bones blocks</li> </ul>	8,4 mm	11,1 mm	130 mm	<b>8868.921</b>
Bone elevator SZ 9		9,4 mm	11,2 mm		<b>8868.922</b>
Bone elevator SZ 10		10,5 mm	12,5 mm		<b>8868.923</b>





		Outer Ø	WL	Product no.
Suture puller WL 350mm	<ul style="list-style-type: none"> <li>Passing the threads to pull in the transplant into the hollow burrs</li> </ul>	4 mm	350 mm	<b>8869.921</b>



|| Subject to modifications. Please note that some products may not be available in all countries. For more detailed information, please consult with your contact partner or directly with Richard Wolf GmbH.

|| Subject to modifications. Please note that some products may not be available in all countries. For more detailed information, please consult with your contact partner or directly with Richard Wolf GmbH.

Knee  
1.5

Knee  
1.5

		WL	Product no.
	<ul style="list-style-type: none"> <li>For introducing the cylindrical bone plug into the femoral tunnel</li> <li>For use via the <b>transibiale</b> portal</li> </ul>	110 mm	<b>8869.991</b>
<b>Curved plunger WL 110mm</b>			

		WL	Product no.
	<ul style="list-style-type: none"> <li>For introducing the cylindrical bone plug into the femoral tunnel</li> <li>For use via the <b>anteromedial</b> portal</li> </ul>	110 mm	<b>8869.993</b>
<b>Pusher straight WL 110mm</b>			

VI121 || Subject to modifications. Please note that some products may not be available in all countries. For more detailed information, please consult with your contact partner or directly with Richard Wolf GmbH.





VI121 || Subject to modifications. Please note that some products may not be available in all countries. For more detailed information, please consult with your contact partner or directly with Richard Wolf GmbH.

		Product no.
	<b>Preparation table, tendon prep. bndl</b> consisting of: Preparation table (88669023) Preparation plate (8866905) Transplant template SZ 5-13mm (8866953) Clamp insert (8866962) Hook clamp (8866935) Parallel screw clamp (8866961) RIWObutton interface (8866969) Tendon transplantat BT / BTB 6mm (8866966) don transplantat BT / BTB 8mm (8866968) Leading hook (8866936)	<b>88669700</b>
	<b>Preparation table</b> (LxWxH) 390 mm x 190 mm x 6 mm	<b>88669023</b>
	<b>Preparation plate</b> (LxB) 380 mm x 60 mm	<b>8866905</b>
	<b>Transplant template SZ 5-13mm</b> oval-shaped tunnels D 5 x 10, D 6 x 12, D 7 x 14	<b>8866953</b>
	<b>Clamp insert</b>	<b>8866962</b>
	<b>Hook clamp</b>	<b>8866935</b>
	<b>Parallel screw clamp</b>	<b>8866961</b>
	<b>RIWObutton interface</b>	<b>8866969</b>
	<b>Tendon transplantat BT / BTB 6mm</b>	<b>8866966</b>
	<b>Tendon transplantat BT / BTB 8mm</b>	<b>8866968</b>
	<b>Leading hook</b>	<b>8866936</b>

	With coupling	Inner Ø	Product no.
 Modular handle I-shaped cannulated	●	3.5 mm	<b>893011135</b>
 Modular handle impact / deflection plate cannulated		3.5 mm	<b>893011136</b>
 Handle I-shaped ID 3.2mm cannulated		3.2 mm	<b>893011132</b>
 Modular handle, t-shaped cannulated		4.0 mm	<b>893011137</b>

VI121 || Subject to modifications. Please note that some products may not be available in all countries. For more detailed information, please consult with your contact partner or directly with Richard Wolf GmbH.

VI121 || Subject to modifications. Please note that some products may not be available in all countries. For more detailed information, please consult with your contact partner or directly with Richard Wolf GmbH.



 891013 050/060/070/080/510/612/714						
 891014070/080/090/100						
ACL		Size	Color coding	Ø	WL	Product no.
	ACL aiming device SZ 5mm	5 mm	blue	2.5 mm	120 mm	<b>891013050</b>
	ACL aiming device SZ 6mm	6 mm	green			<b>891013060</b>
	ACL aiming device SZ 7mm	7 mm	red			<b>891013070</b>
	ACL aiming device SZ 8mm	8 mm	none			<b>891013080</b>
cannulated, for the anteromedial portal	ACL aiming device SZ 5x10mm	oval 5 x 10 mm	blue	2.5 mm	120 mm	<b>891013510</b>
	ACL aiming device SZ 6x12mm	oval 6 x 12 mm	green			<b>891013612</b>
	ACL aiming device SZ 7x14mm	oval 7 x 14 mm	red			<b>891013714</b>
cannulated, for the anteromedial portal	ACL aiming device AT SZ 5mm	5 mm	blue	2.5 mm	120 mm	<b>891015050</b>
	ACL aiming device AT SZ 6mm	6 mm	green			<b>891015060</b>
	ACL aiming device AT SZ 7mm	7 mm	red			<b>891015070</b>
cannulated, for the transfibial portal	ACL aiming device AT SZ 5mm	5 mm	blue	2.5 mm	120 mm	<b>891015050</b>
	ACL aiming device AT SZ 6mm	6 mm	green			<b>891015060</b>
	ACL aiming device AT SZ 7mm	7 mm	red			<b>891015070</b>
PCL						
	PCL aiming device AL SZ 7mm	7 mm	red	2.5 mm	120 mm	<b>891014070</b>
	PCL aiming device AL SZ 8mm	8 mm	none			<b>891014080</b>
	PCL aiming device AL SZ 9mm	9 mm	yellow			<b>891014090</b>
	PCL aiming device AL SZ 10mm	10 mm	white			<b>891014100</b>
cannulated, for the anteromedial portal						

● For use with the modular handles

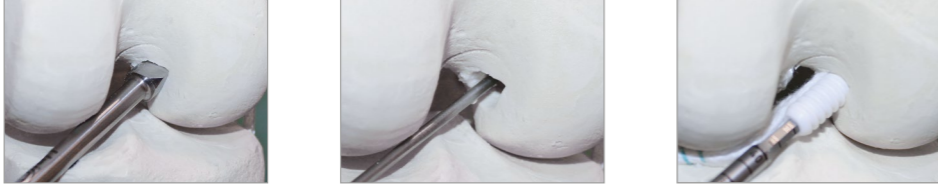
**UniCracker**





For use with the modular handles		WL	Product no.
 <p><b>Univ. tunnel notcher</b> Ø 4–9 mm WL 130mm</p>	Impacting chisel for indentation of the tunnel from Ø 4 to 9 mm, cannulated 2.5 mm	130 mm	<b>891611110</b>



For use with the modular handles		WL	Product no.
 <p><b>Notch chisel WL 130mm</b> one-sided grinding cannulated, Ø 2.5 mm</p>	Gentle graft fixation when using interference screws	130 mm	<b>891511000</b>



		WL	Product no.
 <p><b>Tunnel probe WL 140 mm</b> graduated</p>	For determining the length of the femoral tunnel – particularly when using the RIWObutton to determine the loop length	140 mm	<b>891510012</b>

|| Subject to modifications. Please note that some products may not be available in all countries. For more detailed information, please consult with your contact partner or directly with Richard Wolf GmbH.



|| Subject to modifications. Please note that some products may not be available in all countries. For more detailed information, please consult with your contact partner or directly with Richard Wolf GmbH.

For use with the modular handles		Size	Color coding	WL	Product no.
 <p><b>Tunnel rasp</b> oval, cannulated Ø 2.5 mm</p>	<b>Tunnel rasp</b> Ø 5 x 10mm WL 130mm	5 x 10 mm	blue	130 mm	<b>891611101</b>
	<b>Tunnel rasp</b> Ø 6 x 12mm WL 130mm	6 x 12 mm	green		<b>891611102</b>
	<b>Tunnel rasp</b> Ø 7 x 14mm WL 130mm	7 x 14 mm	red		<b>891611103</b>









For preparing the oval-shaped femoral tunnel on the joint side



For use with the modular handles		Ø	WL	Product no.
 <p>Compactor cannulated Ø 2.5 mm graduated</p>	Compactor SZ 8	8.0	290 mm	891511708
	Compactor SZ 9	9.0		891511709
	Compactor SZ 10	10.0		891511710
<p>Compacting the spongiosa during simultaneous, asymmetric formation of the femoral tunnel using a compactor head flattened at the side. For the positioning and press-fit anchorage of bone plugs for BT and BTB grafts.</p> <p>■ For use with the modular handles</p>				
Also:				
	Deflection sleeve	For removal of compactors		8868.992
	Tunnel stopper	For the direct closure of tibial drill holes		8868.941



VI121 || Subject to modifications. Please note that some products may not be available in all countries. For more detailed information, please consult with your contact partner or directly with Richard Wolf GmbH.



VI121 || Subject to modifications. Please note that some products may not be available in all countries. For more detailed information, please consult with your contact partner or directly with Richard Wolf GmbH.

Single bundle ACL reconstruction				
		Adjustable alignment device bndl consisting of:	Product no.bndl	
		Product no.	8874.013	8874.014
				
	Base section for standard tibial, graduated for alignment hook and spoon and for drill guide	8874.113	•	•
	Aiming spoon tibial ACL	8874.123		•
	Aiming hook tibial ACL	8874.121	•	
		8874.131	•	•
		Alignment wire guide standard SZ 2.5		
Double-bundle ACL reconstruction				Product no.
	Alignment ARC ZG tibial ACL right	For the double-bundle technique on the right knee		8874130
	Zielbügel ZG Tibial ACL links DB	For the double-bundle technique on the left knee		88741301
PCL reconstruction				Product no.
	Aiming spoon ZG tibial			8874129



Hollow drill bit and Ejector	Inner Ø	Outer Ø	WL	Product no.
Hollow drill bit SZ 8	8,5 mm	7,4 mm	185	<b>8869849</b>
also: Ejector SZ 8				<b>8869850</b>
Hollow drill bit 9	9,5 mm	8,4 mm	185 mm	<b>8869.851</b>
also: Ejector SZ 9				<b>8869.852</b>
Hollow drill bit 10	10,5 mm	9,4 mm	185 mm	<b>8869.853</b>
also: Ejector SZ 10				<b>8869.854</b>



Base section, aiming spoon and aiming hook		Product no.
	Base section for tibial drill graduated	<b>8874.111</b>
	Aiming hook tibial ACL	<b>8874.121</b>
	Aiming spoon tibial ACL	<b>8874.123</b>

Alignment wire guide hollow drill SZ 2.5		Product no.
	Alignment wire guide hollow drill SZ 2.5 for use with base section 8874.111	<b>8874.151</b>
	Drill guide for hollow drill bit SZ 8 for use with base section 8874.111 and hollow drill bit 8869849 SZ 8	<b>8874150</b>
	Drill guide for hollow drill bit SZ 9 for use with base section 8874.111 and hollow drill bit 8869.851 SZ 9	<b>8874.152</b>
	Drill guide for hollow drill bit SZ 10 for use with base section 8874.111 and hollow drill bit 8869.853 SZ 10	<b>8874.153</b>

|| Subject to modifications. Please note that some products may not be available in all countries. For more detailed information, please consult with your contact partner or directly with Richard Wolf GmbH.

|| Subject to modifications. Please note that some products may not be available in all countries. For more detailed information, please consult with your contact partner or directly with Richard Wolf GmbH.





	WL	Ø	Product no.
	150 mm	5,0 mm	<b>891511005</b>
		5,5 mm	<b>891511055</b>
		6,0 mm	<b>891511006</b>
		6,5 mm	<b>891511065</b>
		7,0 mm	<b>891511007</b>
		7,5 mm	<b>891511075</b>
		8,0 mm	<b>891511008</b>
		8,5 mm	<b>891511085</b>
		9,0 mm	<b>891511009</b>
		9,5 mm	<b>891511095</b>
		10,0 mm	<b>891511010</b>
		10,5 mm	<b>891511105</b>
		11,0 mm	<b>891511011</b>
		<b>also:</b>	
	Modular handle, t-shaped with coupling, cannulated		<b>893011137</b>

|| Subject to modifications. Please note that some products may not be available in all countries. For more detailed information, please consult with your contact partner or directly with Richard Wolf GmbH.

|| Subject to modifications. Please note that some products may not be available in all countries. For more detailed information, please consult with your contact partner or directly with Richard Wolf GmbH.



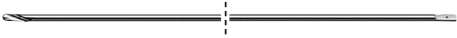
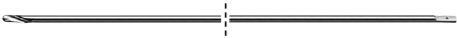
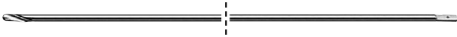

graft<sup>line</sup>  
Preparing the Tibial Tunnel  
Cannulated head drill

	WL	Ø	Product no.
    <p><b>Head drill</b> cannulated, Ø 2.65 mm TiN coating</p> <p>For alignment wire / Kirschner wire Ø 2.5 mm</p>	145 mm	4.5 mm	<b>89960.1045</b>
		5.0 mm	<b>89960.1050</b>
		5.5 mm	<b>89960.1055</b>
		6.0 mm	<b>89960.1060</b>
		6.5 mm	<b>89960.1065</b>
		7.0 mm	<b>89960.1070</b>
		7.5 mm	<b>89960.1075</b>
		8.0 mm	<b>89960.1080</b>
		8.5 mm	<b>89960.1085</b>
		9.0 mm	<b>89960.1090</b>
		9.5 mm	<b>89960.1095</b>
		10.0 mm	<b>89960.1010</b>
		10.5 mm	<b>89960.1910</b>
		11.0 mm	<b>89960.1011</b>
11.5 mm	<b>89960.1911</b>		
12.5 mm	<b>89960.1012</b>		
12.5 mm	<b>89960.1912</b>		
13.0 mm	<b>89960.1013</b>		
 <p><b>Kirschner alignment wire Ø 2.5mm</b> triangular grinding</p>	TL 300 mm without suture eyelet	2.5 mm	<b>89120.3025</b>
 <p><b>Kirschner alignment wire Ø 2.5mm</b> spiral grinding</p>	TL 310 mm without suture eyelet	2.5 mm	<b>89960.1025</b>
 <p><b>Kirschner alignment wire Ø 2.5mm</b> spiral grinding</p>	TL 430 mm with suture eyelet	2.5 mm	<b>89960.1125</b>

|| Subject to modifications. Please note that some products may not be available in all countries. For more detailed information, please consult with your contact partner or directly with Richard Wolf GmbH.

|| Subject to modifications. Please note that some products may not be available in all countries. For more detailed information, please consult with your contact partner or directly with Richard Wolf GmbH.

graft<sup>line</sup>  
Perforated Baskets for Instruments  
Knee Arthroscopy  
Sterilization – storage – transport

Illustration	Description	Product no.
 <p><b>Perf. basket – knee arthrosc. Basic set</b></p>	<p>Holds: knee arthroscopy basic set, for sterilization (steam and low-temperature), storage and transport, with instrument holders, inner dimensions (wxhxd): 513x134x233mm, outer dimensions (wxhxd): 549x150x250mm</p>	<b>33007</b>
 <p><b>Perf. basket – knee arthrosc. ACL/PCL 1</b></p>	<p>Holds: instrument set for knee arthroscopy ACL/PCL 1, for sterilization (steam and low-temperature), storage and transport, with instrument holders, inner dimensions (wxhxd): 513x134x233mm, outer dimensions (wxhxd): 549x150x250mm</p>	<b>33008</b>
 <p><b>Perf. basket – knee arthrosc. ACL/PCL 2</b></p>	<p>Holds: instrument set for knee arthroscopy ACL/PCL 2, for sterilization (steam and low-temperature), storage and transport, with instrument holders, inner dimensions (wxhxd): 513x134x233mm, outer dimensions (wxhxd): 549x150x250mm</p>	<b>33009</b>
 <p><b>Perf. basket For knee arthrosc. prep tab</b></p>	<p>Holds: knee arthroscopy preparation table, for sterilization (steam and low-temperature), storage and transport, with instrument holders, inner dimensions (wxhxd): 513x134x233mm, outer dimensions (wxhxd): 549x150x250mm</p>	<b>33010</b>

passend für Standard Container (1 STE = 1 Sterilguteinheit)



Tendon anchor		Size	Product no.
 <p><b>T-Lock OSTEOTRANS</b></p> <p>T-Lock OSTEOTRANS tendon anchor, sterile</p>		6	OLRA-6
		7	OLRA-7
		8	OLRA-8
		9	OLRA-9

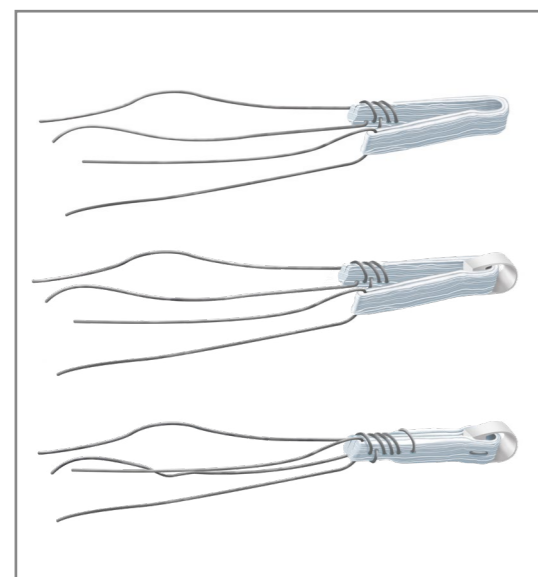



**BioactIF OSTEOTRANS**

"OK" interference screws



	Thread Ø	Length	Hole	Product no.
BioactIF OSTEOTRANS 7 X 25, sterile	/ mm	25 mm	2.2 mm	OK0725A
BioactIF OSTEOTRANS 7 X 30, sterile		30 mm		OK0730A
BioactIF OSTEOTRANS 8 X 25, sterile	8 mm	25 mm		OK0825
BioactIF OSTEOTRANS 8 X 30, sterile		30 mm		OK0830
BioactIF OSTEOTRANS 9 X 25, sterile	9 mm	25 mm		OK0925
BioactIF OSTEOTRANS 9 X 30, sterile		30 mm		OK0930



Screwdriver	For interference screws with thread size	Product no.
 <p>Screwdriver OK/BK SZ 7 -11 mm cannulated, color code red, graduated</p>	7-11 mm	891800030



Thread cutter	For OK screws	Product no.
 <p>Thread cutter for OK screws SZ 7 mm</p>	Size 7 mm	891800700
Thread cutter for OK screws SZ 8 mm	Size 8 mm	891800800
Thread cutter for OK screws SZ 9 mm	Size 9 mm	891800900



Guide wire	Ø	TL	Product no.
 <p>Nitinol guide wire Ø 1.2mm</p>	1.2 mm	350 mm	89120.2012

VI121 || Subject to modifications. Please note that some products may not be available in all countries. For more detailed information, please consult with your contact partner or directly with Richard Wolf GmbH.

VI121 || Subject to modifications. Please note that some products may not be available in all countries. For more detailed information, please consult with your contact partner or directly with Richard Wolf GmbH.

**Bioact<sup>IF</sup> OSTEOTRANS**

"BK" interference screws

	Thread Ø	Length	Hole	Product no.
BioactIF OSTEOTRANS 6 X 20, sterile	6 mm	20 mm	1.7 mm	<b>BK0620</b>
BioactIF OSTEOTRANS 7 X 20, sterile	7 mm	20 mm		<b>BK0720</b>
BioactIF OSTEOTRANS 7 X 25, sterile		25 mm		<b>BK0725</b>
BioactIF OSTEOTRANS 7 X 30, sterile		30 mm		<b>BK0730</b>
BioactIF OSTEOTRANS 8 X 20, sterile		20 mm		<b>BK0820</b>
BioactIF OSTEOTRANS 8 X 25, sterile	8 mm	25 mm		<b>BK0825</b>
BioactIF OSTEOTRANS 8 X 30, sterile		30 mm		<b>BK0830</b>
BioactIF OSTEOTRANS 9 X 20, sterile	9 mm	20 mm		<b>BK0920</b>
BioactIF OSTEOTRANS 9 X 25, sterile		25 mm		<b>BK0925</b>
BioactIF OSTEOTRANS 9 X 30, sterile		30 mm		<b>BK0930</b>
BioactIF OSTEOTRANS 10 X 25, sterile	10 mm	25 mm	<b>BK1025</b>	
BioactIF OSTEOTRANS 10 X 30, sterile		30 mm	<b>BK1030</b>	





891800020



891800030

Screwdriver		for interference screws with thread size	Product no.
	<b>Screwdriver BK SZ 6MM</b> cannulated, color code black, graduated	6 mm	<b>891800020</b>
	<b>Screwdriver OK/BK SZ 7 -11mm</b> cannulated, color code red, graduated	7-11 mm	<b>891800030</b>





Guide wire	Ø	TL	Product no.	
	Nitinol guide wire Ø 1.2mm	1.2 mm	350 mm	<b>89120.2012</b>

|| Subject to modifications. Please note that some products may not be available in all countries. For more detailed information, please consult with your contact partner or directly with Richard Wolf GmbH.

|| Subject to modifications. Please note that some products may not be available in all countries. For more detailed information, please consult with your contact partner or directly with Richard Wolf GmbH.

**Bioact<sup>IF</sup> OSTEOTRANS**

"RK" interference screws

conical, absorbable, sterile	Thread Ø	Length	Hole	Product no.
Bioactif OSTEOTRANS OD 6mm L 20mm	6 mm	20 mm	1,5 mm	<b>RK0620</b>
Bioactif OSTEOTRANS OD 7mm L 20mm	7 mm	20 mm		<b>RK0720</b>
Bioactif OSTEOTRANS OD 7mm L 25mm		25 mm		<b>RK0725</b>
Bioactif OSTEOTRANS OD 7mm L 30mm		30 mm		<b>RK0730</b>
Bioactif OSTEOTRANS OD 8mm L 20mm		8 mm		20 mm
Bioactif OSTEOTRANS OD 8mm L 25mm	25 mm			<b>RK0825</b>
Bioactif OSTEOTRANS OD 8mm L 30mm	30 mm			<b>RK0830</b>
Bioactif OSTEOTRANS OD 9mm L 20mm	9 mm	20 mm		<b>RK0920</b>
Bioactif OSTEOTRANS OD 9mm L 25mm		25 mm		<b>RK0925</b>
Bioactif OSTEOTRANS OD 9mm L 30mm		30 mm		<b>RK0930</b>
Bioactif OSTEOTRANS OD 10mm L 25mm	10 mm	25 mm		<b>RK1025</b>



891800021



891800031

		for interference screws with thread size	Product no.
	<b>Screwdriver RK SZ 5 -6mm</b> cannulated, color code red, graduated	6 mm	<b>891800021</b>
	<b>Screwdriver RK GR 7 -11mm</b> cannulated, color code yellow, graduated	7 - 11 mm	<b>891800031</b>

graft<sup>line</sup>

Graft Fixation

Guide Wire



Guide wire	Ø	TL	Product no.
	Nitinol guide wire Ø 1.2mm	1.2 mm	89120.2012

Knee

1.5



## Shoulder

## Shoulder

---

**1** Standard Equipment / Arthroscopes

---

**2** ARTHROline Punches

---

**3** Hook Probe / Marking Rod

---

**4** Reconstructive Shoulder Arthroscopy

---

## Basic Equipment

### for shoulder arthroscopy

Product	Product no.	Quantity	Catalog / Section
<b>Endoscopes and Instruments</b>			
PANOVIEW telescope 30° Ø 4mm SL 170mm	<b>8880.543</b>	1	Orthopedics / Shoulder
Fiber light cable bndl, Ø 3.5mm, 2.3m long	<b>806635231</b>	1	
Sheath for arthroscope OD 6mm	<b>89121.1260</b>	1	
Obturator for arthroscope OD 5.5/6/6.3mm tip, semi-blunt	<b>89121.0542</b>	1	
Hook probe WL 115mm H 4.5mm graduated	<b>8399.95</b>	1	
ARTHROline punch W 4.6mm H 1.6mm jaws curved upward	<b>89140.0102</b>	1	
ARTHROline punch W 5.5mm H 1.6mm jaws curved upward, sheath curved to the left	<b>89140.0103</b>	1	
ARTHROline punch W 4.6mm H 1.6mm jaw section serrated, sheath curved upward	<b>89140.0122</b>	1	
ARTHROline hook punch W 4mm H 21.1mm straight jaw section	<b>89140.0405</b>	1	

Overview

arthro <sup>lution</sup>		Fingers, toes	Hand	Foot, elbow		Knee, shoulder, hip	
Telescope Ø		1.9 mm	2.4 mm	2.7 mm		4.0 mm	
Telescopes	30°	PANOVIEW telescope	<b>8860453</b>	<b>8871413</b>	<b>8476.433</b>	<b>8672.422</b>	<b>8880.543</b>
		PANOVIEW wide angle telescope					<b>8885.443</b>
	70°	PANOVIEW telescope					<b>8880.545</b>
		PANOVIEW wide angle telescope					<b>8885.445</b>
Sheath WL		40 mm	60 mm	77.5 mm	145 mm	130 mm	
Sheaths	with 1 irrigation stopcock, fixed		<b>891220124</b>	<b>891220132</b>			
	with 2 irrigation stopcocks, fixed						<b>89121.0260</b>
	with 1 irrigation stopcock, rotatable					<b>891241141</b>	
	with 2 irrigation stopcocks, rotatable			<b>891221232</b>	<b>891221241</b>	<b>891241241</b>	<b>89121.1260</b>
	High-Flow with 1 irrigation stopcock, fixed		<b>891220128</b>				
	High-Flow with 2 irrigation stopcocks, rotatable			<b>891221235</b>			<b>89121.1263</b>
	Small-caliber with 2 irrigation stopcocks, rotatable						<b>891221255</b>
Obturator	blunt				<b>891222754</b>		<b>89121.0544</b>
	semi-blunt		<b>891221952</b>	<b>891222452</b>			<b>89121.0542</b>
	conical blunt				<b>891222750</b>	<b>891242750</b>	<b>89121.0540</b>
	sharp					<b>891242761</b>	<b>89121.0640</b>
	conical pointed		<b>891221962</b>	<b>891222462</b>	<b>891222762</b>		
Sealing part for sheath						<b>891040000</b>	

|| Subject to modifications. Please note that some products may not be available in all countries. For more detailed information, please consult with your contact partner or directly with Richard Wolf GmbH.

|| Subject to modifications. Please note that some products may not be available in all countries. For more detailed information, please consult with your contact partner or directly with Richard Wolf GmbH.

Arthroscope  
with PANOVIEW Telescope Ø 4 mm

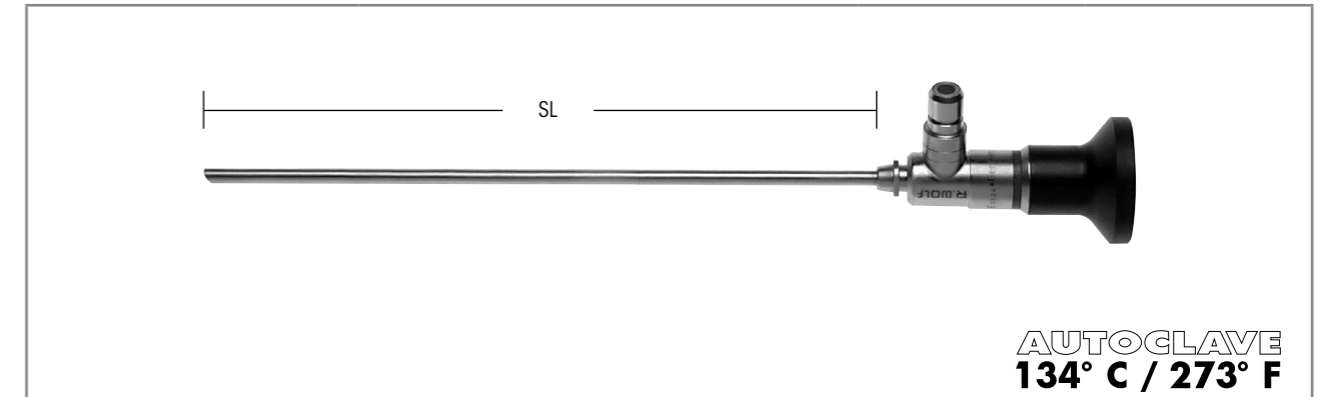

**AUTOCLAVE**  
**134° C / 273° F**

Direction of view		SL	Ø	Product no.
0°	PANOVIEW telescope 0° Ø 4mm SL 170mm	170 mm	4.0 mm	<b>8880.541</b>
30°	PANOVIEW telescope 30° Ø 4mm SL 170mm			<b>8880.543</b>
45°	PANOVIEW telescope 45° Ø 4mm SL 170mm			<b>8880.544</b>
70°	PANOVIEW telescope 70° Ø 4mm SL 176mm	176 mm		<b>8880.545</b>

Recommended accessories		Product no.
Perf. basket for standard telescope 1	(L x B x H) 297 x 59 x 54 mm	<b>38015</b>
Fiber light cable bndl Comprising: Fiber light cable (80663523), adapter projector side (8095.07) and adapter endoscope side (809509)	Ø 3.5 mm, 2.3 m long	<b>806635231</b>

**arthro** Sheath for Arthroscope  
*lution*

with automatic click-lock mechanism

<b>Sheath for arthroscope OD 6mm</b>							<b>Obturator for arthroscope 5.5/6/6.3mm blunt</b>	<b>Obturator for arthroscope 5.5/6/6.3mm semi-blunt</b>	<b>Obturator for arthroscope 5.5/6/6.3mm conical blunt</b>	<b>Trocar tip, triangular SZ 4mm WL 176mm</b>
High-Flow	Small-caliber	2 fixed stopcocks	2 rotatable stopcocks	Outer Ø	WL	Product no.				
		•		6.0 mm	132 mm	<b>89121.0260</b>	<b>89121.0544</b>	<b>89121.0542</b>	<b>89121.0540</b>	
			•	6.0 mm	130 mm	<b>89121.1260</b>				
•			•	6.3 mm	130 mm	<b>89121.1263</b>				
	•		•	5.5 mm	130 mm	<b>891221255</b>				

Spare parts	Product no.
Irrigation ring with 1 stopcock	<b>150081761</b>
Irrigation ring with 2 stopcocks	<b>150081762</b>
Stopcock insert, bundle, cap 3.0mm (PACK= 5 PCS) Also: Disassembly tool	<b>896.0002</b> <b>38310.0001</b>
Mounting ring	<b>15008.1704</b>
Spare sealing comprising: O-rings, small / large, 5 of each Also: O-ring tool (disassembly tool)	<b>15176.142</b> <b>15106.230</b>

Recommended accessories	Product no.
Sealing part for sheath	<b>89101.0000</b>
Marking rod Ø 4.0mm conical blunt TL 325 mm	<b>8863.75</b>

VI121 || Subject to modifications. Please note that some products may not be available in all countries. For more detailed information, please consult with your contact partner or directly with Richard Wolf GmbH.

VI121 || Subject to modifications. Please note that some products may not be available in all countries. For more detailed information, please consult with your contact partner or directly with Richard Wolf GmbH.



**arthro** Punch  
*line*

ARTHROline	Jaw section (Height x width)	Cut width	WL	Straight	Curved to the right	Curved to the left	Sheath curved upward	Jaw section curved upward	Product no.	
<b>Punch W 4.6mm H 1.6mm</b> movable jaw section serrated	1.6 x 4.6 mm	3.3 mm	120 mm	•					<b>89140.0105</b>	
<b>Punch W 4.6mm H 1.6mm</b> movable jaw section serrated							•		<b>89140.0102</b>	
<b>Punch W 4. mm H 1.6mm</b> movable jaw section serrated									•	<b>89140.0122</b>
<b>Punch W 5.5mm H 1.6mm</b> movable jaw section serrated				1.6 x 5.5 mm				•		•
<b>Punch W 5.5mm H 1.6mm</b> movable jaw section serrated			•				•	<b>89140.0103</b>		



## Hook Probe / Marking Rod



	H	WL	Product no.
<b>Hook probe WL 115mm H 7mm, graduated</b> 	7.0 mm	115 mm	<b>8399.901</b>
<b>Hook probe WL 115mm H 4.5mm, graduated</b> 	4.5 mm		

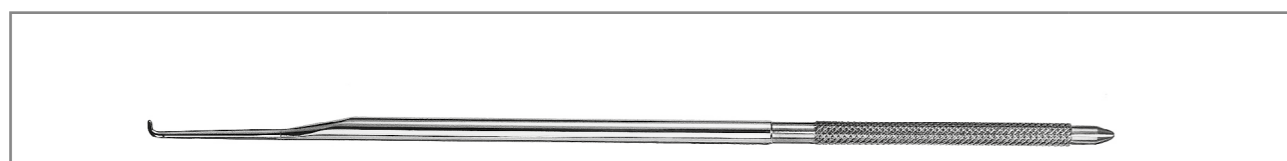

	Ø	TL	Product no.
<b>Hook probe TL 228 mm SZ 4.4mm</b> 	4.4 mm	228 mm	<b>8863.80</b>

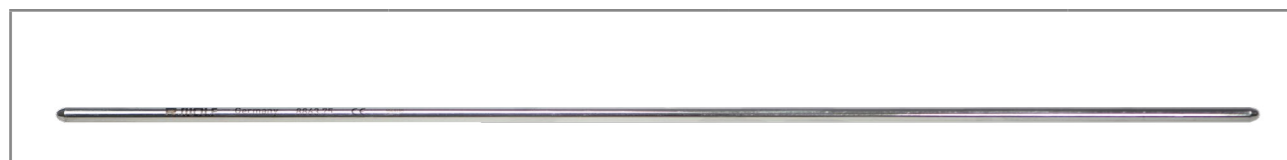

	Ø	TL	Product no.
<b>Marking rod Ø 4.0mm conical blunt</b> 	4.0 mm	325 mm	<b>8863.75</b>

|| Subject to modifications. Please note that some products may not be available in all countries. For more detailed information, please consult with your contact partner or directly with Richard Wolf GmbH.

|| Subject to modifications. Please note that some products may not be available in all countries. For more detailed information, please consult with your contact partner or directly with Richard Wolf GmbH.

## Basic Instrument Set

for reconstructive shoulder arthroscopy

Product	Product no.	Quantity	Catalog / Section
<b>Endoscopes and Instruments</b>			
Knot pusher WL 170mm	<b>89150.3000</b>	1	Orthopedics / Shoulder
Suture catcher WL 160mm	<b>89150.3003</b>	1	
Concave rasp WL 175mm W 4.75mm	<b>89160.3003</b>	1	
Convex rasp WL 175 mm W 4.75mm	<b>89160.3002</b>	1	
Straight rasp WL 175mm W 4.75mm	<b>89160.3005</b>	1	
Knife angled 15° WL 160mm W 4.5mm	<b>89160.3015</b>	1	
Distally cutting knife WL 160mm W 4.5mm	<b>89160.3001</b>	1	
Suture cutter Ø 5mm WL 200mm	<b>891603000</b>	1	
Suture grasping forceps Ø 3.3mm	<b>891303300</b>	1	
Grasping forceps Ø 3.4mm	<b>8488.096</b>	1	
Marking rod Ø 4.0mm, conical blunt	<b>8863.75</b>	1	
ENDOSPIKE shoulder suture instrument Ø 5.3mm	<b>891403000</b>	1	
Also: Needles for suture forceps, sterile	<b>491403000</b>	1	
Perf. basket for shoulder arthroscopy	<b>33012</b>	1	

**Endospike**

Shoulder Suture Instrument



	Ø	WL	Product no.
<b>ENDOSPIKE</b> shoulder suture instrument Ø 5.3mm	5.3 mm	169 mm	<b>891403000</b>
with irrigation connector, can be dismantled			
Also:			
<b>Needles for stitching forceps,</b> sterile, disposable (PACK= 5 PCS)			<b>491403000</b>

VI121 || Subject to modifications. Please note that some products may not be available in all countries. For more detailed information, please consult with your contact partner or directly with Richard Wolf GmbH.

VI121 || Subject to modifications. Please note that some products may not be available in all countries. For more detailed information, please consult with your contact partner or directly with Richard Wolf GmbH.

Suture Cutter / Suture Grasping Forceps

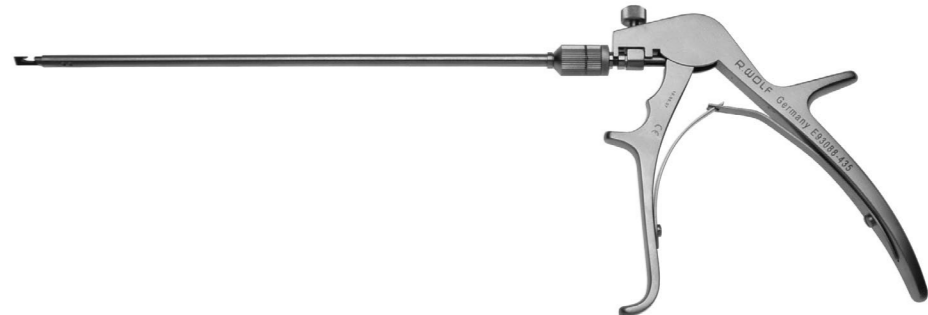

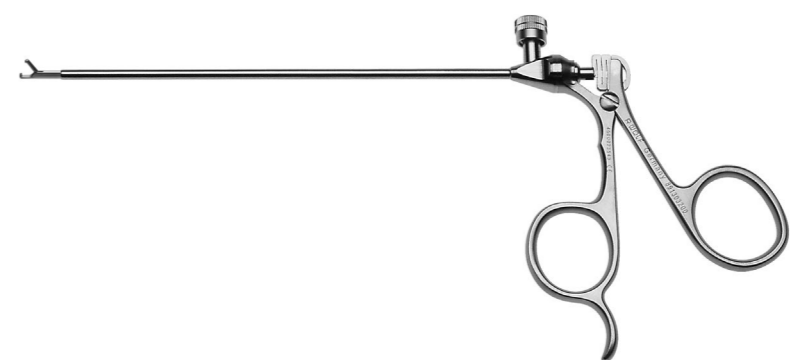

	Ø	WL	Product no.
<b>Suture cutter Ø 5mm WL 200mm</b>	5.0 mm	200 mm	<b>891603000</b>
can be dismantled			

	Ø	WL	Product no.
<b>Suture grasping forceps Ø 3.3mm</b>	3.3 mm	160 mm	<b>891303300</b>
jaw section straight, sheath straight			
<b>Suture grasping forceps Ø 3.3mm</b>			<b>891303200</b>
straight jaw section, pointed			
<b>Suture grasping forceps Ø 3.3mm</b>			<b>891303230</b>
jaw section curved 45° upward, pointed			

## Grasping Forceps

			
	Ø	WL	Product no.
<b>Grasping forceps Ø 3.4mm</b>  straight jaw section, serrated, handle with lock	3.4 mm	130 mm	<b>8488.096</b>

Grasping forceps for holding and repositioning the rotator cuff.

## Hand Instruments

		WL	Product no.
<b>Knot pusher WL 170 mm</b> 	For applying and tightening slip knots in arthroscopically applied sutures	170 mm	<b>89150.3000</b>
<b>Suture catcher WL 160mm</b> 	Hook eye for suture management	160 mm	<b>89150.3003</b>
<b>Distally cutting knife WL 160mm W 4.5mm</b> 	For loosening soft tissue from the glenoid edge	160 mm	<b>89160.3001</b>
<b>Knife angled 15° WL 160mm W 4.5mm</b> 			<b>89160.3015</b>
<b>Convex rasp WL 175mm W 4.75mm</b> rough 	For arthroscopic "freshening" of the bone at the glenoid in Bankart and SLAP lesions and of the greater tubercle in reconstruction of the rotator cuff	175 mm	<b>89160.3002</b>
<b>Concave rasp WL 175mm W 4.75mm</b> rough 			<b>89160.3003</b>
<b>Straight rasp WL 175mm W 4.75mm</b> rough 			<b>89160.3005</b>

VI121 || Subject to modifications. Please note that some products may not be available in all countries. For more detailed information, please consult with your contact partner or directly with Richard Wolf GmbH.

VI121 || Subject to modifications. Please note that some products may not be available in all countries. For more detailed information, please consult with your contact partner or directly with Richard Wolf GmbH.

# Sterilization Basket

## for Instruments Used in Shoulder Arthroscopy

Sterilization – storage – transport

Illustration	Description	Product no.
 <p><b>Perf. Basket for shoulder arthroscopy</b></p> <p>also:</p> <p><b>Fixing ring Ø 50.39mm</b></p>	<p>Holds: instrument set for shoulder arthroscopy, for sterilization (steam and low-temperature), storage and transport, with instrument holders, inner dimensions (wxhxd): 513x95x233mm, outer dimensions (wxhxd): 538x117x250mm</p> <p>for perforated basket for flexible endoscopes, for fixing instruments during machine reprocessing, sterilization (steam and low-temperature), storage and transport, Ø 50,39x3,53mm, PACK=10 PCS</p>	<p><b>33012</b></p> <p><b>643301261</b></p>

Suitable for standard container

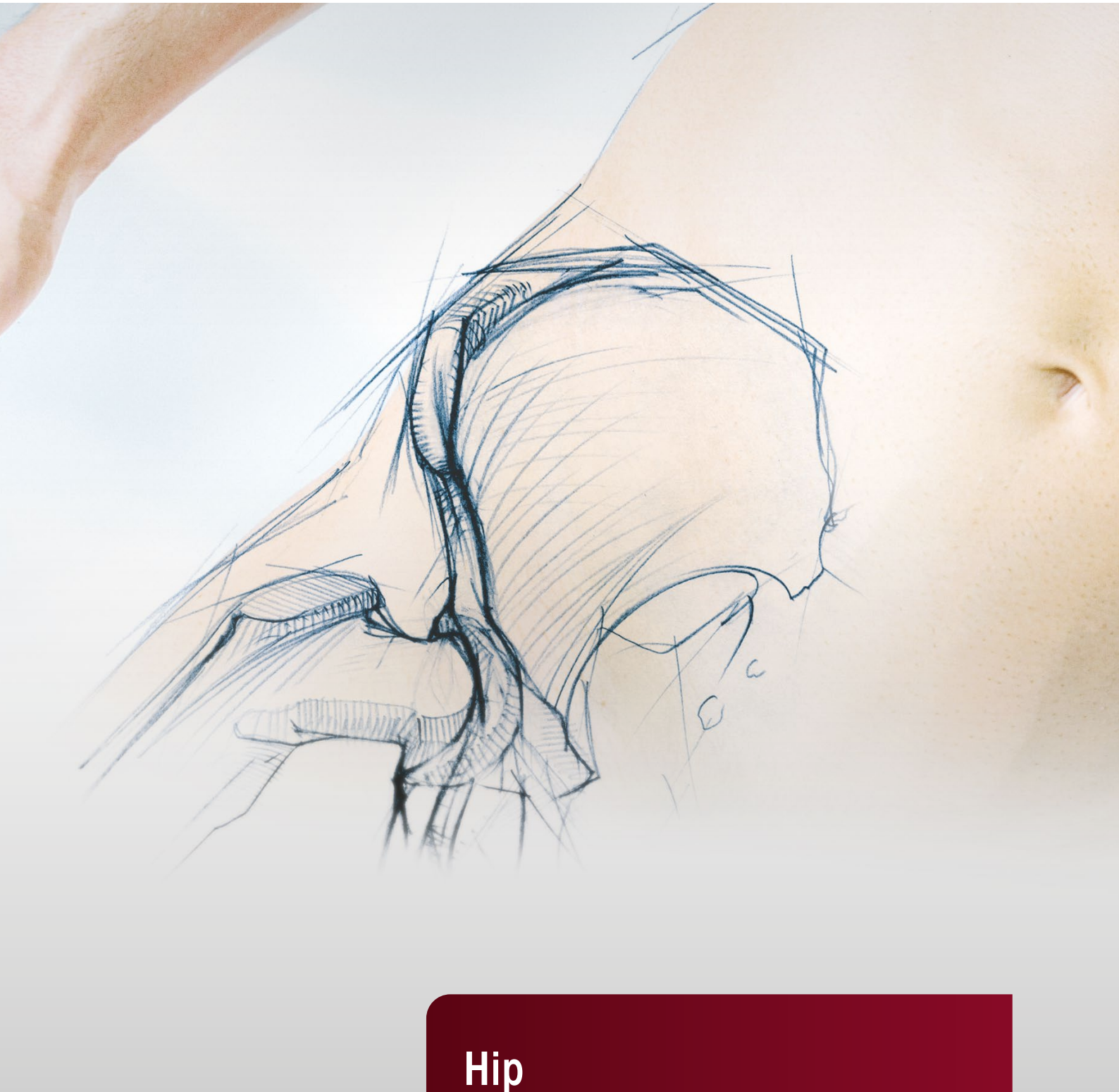

# Hip

# Hip

3.1

**Arthrolution Arthroscopes Overview**

3.2

**Telescopes and Sheaths**

3.3

**Access Instruments**

3.4

**Dilation Systems**

3.5

**Irrigation Cannula**

3.6

**Aiming Device**

3.7

**Instruments**

## Overview

arthro <i>lution</i>			Fingers, toes	Hand	Foot, elbow		Knee, shoulder, hip
Telescope Ø			1.9 mm	2.4 mm	2.7 mm		4.0 mm
Telescopes	30°	PANOVIEW telescope	<b>8860453</b>	<b>8871413</b>	<b>8476.433</b>	<b>8672.422</b>	<b>8880.543</b>
		PANOVIEW wide angle telescope					<b>8885.443</b>
	70°	PANOVIEW telescope					<b>8880.545</b>
		PANOVIEW wide angle telescope					<b>8885.445</b>
Sheath WL			40 mm	60 mm	77.5 mm	145 mm	130 mm
Sheaths	with 1 irrigation stopcock, fixed		<b>891220124</b>	<b>891220132</b>			
	with 2 irrigation stopcocks, fixed						<b>89121.0260</b>
	with 1 irrigation stopcock, rotatable					<b>891241141</b>	
	with 2 irrigation stopcocks, rotatable			<b>891221232</b>	<b>891221241</b>	<b>891241241</b>	<b>89121.1260</b>
	High-Flow with 1 irrigation stopcock, fixed		<b>891220128</b>				
	High-Flow with 2 irrigation stopcocks, rotatable			<b>891221235</b>			<b>89121.1263</b>
	Small-caliber with 2 irrigation stopcocks, rotatable						<b>891221255</b>
Obturator	blunt				<b>891222754</b>		<b>89121.0544</b>
	semi-blunt		<b>891221952</b>	<b>891222452</b>			<b>89121.0542</b>
	conical blunt				<b>891222750</b>	<b>891242750</b>	<b>89121.0540</b>
	sharp					<b>891242761</b>	<b>89121.0640</b>
	conical pointed		<b>891221962</b>	<b>891222462</b>	<b>891222762</b>		
Sealing part for sheath						<b>891040000</b>	

# COXARTIS

Telescope Ø 4 mm  
for 4 mm arthroscopes

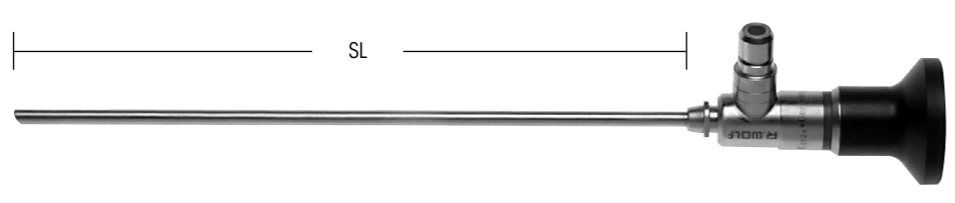

Direction of view		SL	Ø	Product no.
0°	PANOVIEW telescope 0° Ø 4mm SL 170mm	170 mm	4.0 mm	<b>8880.541</b>
30°	PANOVIEW telescope 30° Ø 4mm SL 170mm			<b>8880.543</b>
45°	PANOVIEW telescope 45° Ø 4mm SL 170mm			<b>8880.544</b>
70°	PANOVIEW telescope 70° Ø 4mm SL 171mm	176 mm		<b>8880.547</b>

Recommended accessories		Product no.
Perf. basket for standard telescope 1	(L x B x H) 297 x 59 x 54 mm	<b>38015</b>
Fiber light cable bndl Comprising: Fiber light cable (80663523), adapter projector side (8095.07) and adapter endoscope side (809509)	Ø 3.5 mm, 2.3 m long	<b>806635231</b>

|| Subject to modifications. Please note that some products may not be available in all countries. For more detailed information, please consult with your contact partner or directly with Richard Wolf GmbH.

|| Subject to modifications. Please note that some products may not be available in all countries. For more detailed information, please consult with your contact partner or directly with Richard Wolf GmbH.

# COXARTIS

Sheath Ø 4 mm  
for 4 mm arthroscopes

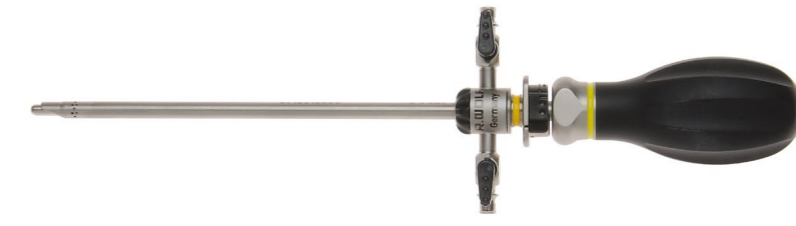

	2 rotatable stopcocks	Outer Ø	WL	Product no.	Obturator for arthroscope OD 6/6.3mm cannulated, capacity 2mm
ArthroLution sheath for arthroscope OD 6mm with automatic click-lock mechanism	●	6.0 mm	145 mm	<b>8912312603</b>	<b>891234073</b>
Also: Sealing part for sheath					<b>89101.0000</b>



For continuous irrigation Comprising:		2 rotatable stopcocks	Outer Ø	WL	Product no.	Obturator for arthroscope OD 5.3/6 mm, semi-blunt, capacity 2mm
ArthroLution sheath and outer sheath	ArthroLution sheath for arthroscope OD 5.3mm, with automatic click-lock mechanism		5.3 mm		<b>8912312533</b>	<b>891234052</b>
	Outer sheath for arthroscope OD 6.3mm	●	6.3 mm	130 mm	<b>8912300633</b>	
Also: Sealing part for sheath						<b>89101.0000</b>



# COXARTIS

Telescope and Sheath Systems  
for 4 mm arthroscopes, extra long

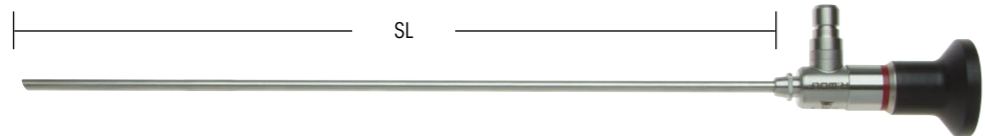

**AUTOCLAVE**  
**134° C / 273° F**

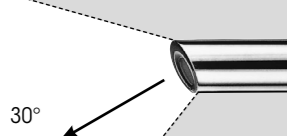
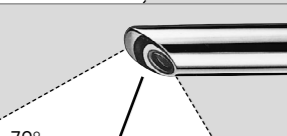
Direction of view		SL	Ø	Product no.
	PANOVIEW telescope 30° Ø 4 mm SL 248 mm	248 mm	4.0 mm	<b>891134030</b>
	PANOVIEW telescope 70° Ø 4 mm SL 251 mm	251 mm		<b>891134070</b>

Recommended accessories		Product no.
Perf. basket for standard telescope 1	(L x B x H) 297 x 59 x 54 mm	<b>38015</b>
Fiber light cable bndl Comprising: Fiber light cable (80663523), adapter projector side (8095.07) and adapter endoscope side (809509)	Ø 3.5 mm, 2.3 m long	<b>806635231</b>



	2 rotatable stopcocks	Outer Ø	WL	Product no.	Obturator for arthroscope OD 6 mm, cannulated, capacity 2 mm
ArthroLution sheath for arthroscope OD 6mm, with automatic click-lock mechanism	●	6.0 mm	145 mm	<b>8912312607</b>	<b>891234077</b>
Also: Sealing part for sheath					<b>89101.0000</b>

|| Subject to modifications. Please note that some products may not be available in all countries. For more detailed information, please consult with your contact partner or directly with Richard Wolf GmbH.

|| Subject to modifications. Please note that some products may not be available in all countries. For more detailed information, please consult with your contact partner or directly with Richard Wolf GmbH.

# COXARTIS

Access Instruments  
Cannula for punction, guide wire, marking rod



	Ø	Capacity	WL	Product no.
<b>Cannula for punction Ø 2.6/2mm WL 200mm</b> with internal needle, (PACK= 2 PCS)	2.6 mm	2.0 mm	200 mm	<b>891732018</b>



	Ø	TL	Product no.
<b>Nitinol guide wire Ø 2mm</b> (PACK= 2 PCS)	2.0 mm	450 mm	<b>891534020</b>



	Ø	Capacity	TL	Product no.
<b>Marking rod Ø 4.0mm</b> cannulated	4.0 mm	2.25 mm	325 mm	<b>891532040</b>
<b>Marking rod Ø 4.0mm</b> conical blunt	4.0 mm	-	325 mm	<b>8863.75</b>

**COXARTIS**  
Access Instruments  
Guide tube



	Ø	Capacity	WL	Product no.
Guide sheath slitted WL 120 mm SZ 7 mm slotted	2.6 mm	2 mm	200 mm	<b>891237012</b>
Obturator for guide tube cannulated			142 mm	<b>891232070</b>

|| Subject to modifications. Please note that some products may not be available in all countries. For more detailed information, please consult with your contact partner or directly with Richard Wolf GmbH.

|| Subject to modifications. Please note that some products may not be available in all countries. For more detailed information, please consult with your contact partner or directly with Richard Wolf GmbH.

**COXARTIS**  
Access Instruments  
Dilation system



	Color coding	Ø	Capacity	WL	Product no.
Dilatator Ø 5mm WL 200mm cannulated	green	5.0 mm	2.0 mm	200 mm	<b>891532050</b>
Dilatator Ø 7mm WL 200mm cannulated	blue	7.0 mm			<b>891532070</b>
Dilatator Ø 9mm WL 200mm cannulated	red	9.0 mm			<b>891532090</b>
Handle attachment for dilators					<b>891530000</b>

# COXARTIS

## Irrigation Cannula



	Ø	Capacity	WL	Product no.
Cannula for irrigation Ø 8mm WL 168mm	8 mm	7 mm	168 mm	<b>891737080</b>

VI121 || Subject to modifications. Please note that some products may not be available in all countries. For more detailed information, please consult with your contact partner or directly with Richard Wolf GmbH.

VI121 || Subject to modifications. Please note that some products may not be available in all countries. For more detailed information, please consult with your contact partner or directly with Richard Wolf GmbH.

Hip  
3.5

# COXARTIS

## Aiming Device



		Product no.
<b>Aiming device bndl</b> Comprising:	Hip alignment ARC (891240100), Hip guide sleeve (891240200), Guide attachment AD hip (891240300), Rotatable irrigation ring hip (891240400)	<b>891240000</b>
<b>Hip alignment ARC</b> with adapter for rotatable irrigation ring		891240100
<b>Hip guide sleeve</b> for connection to puncture cannula 891732018		891240200
<b>Guide attachment AD hip</b> for connection to guide sleeve		891240300
<b>Rotatable irrigation ring hip</b> rotatable with 2 stopcocks and adapter for alignment bracket		891240400

Hip  
3.6

# COXARTIS

## Hook Probe / Banana Knife



spirit of excellence

			
	Height	WL	Product no.
Hook probe WL 150mm H 4.5mm	4.5 mm	150 mm	<b>891534515</b>
			

		
	WL	Product no.
Banana knife WL 125mm	125 mm	<b>8436.251</b>
		

			
	Width	WL	Product no.
Convex rasp WL 175mm W 4.75mm	4.75 mm	175 mm	<b>89160.3002</b>
			

|| Subject to modifications. Please note that some products may not be available in all countries. For more detailed information, please consult with your contact partner or directly with Richard Wolf GmbH.

|| Subject to modifications. Please note that some products may not be available in all countries. For more detailed information, please consult with your contact partner or directly with Richard Wolf GmbH.







# COXARTIS

## Curette and Microfractor



spirit of excellence

				
		Ø	WL	Product no.
Curette, square, Ø 4.5mm WL 170mm	double-blade and curved upward	4.5 mm	170 mm	<b>891632245</b>
Curette, square, Ø 5mm WL 170mm		5.0 mm		<b>891632260</b>
Curette, round, Ø 4.8mm WL 170mm		4.8 mm		<b>891631255</b>
Curette, round, Ø 6.3mm WL 170mm		6.3 mm		<b>891631270</b>
				
				
				
				

			
	Deflection	WL	Product no.
Microfractor WL 170mm 15°	Curved 15°	170 mm	<b>891631521</b>
Microfractor WL 170mm 30°	Curved 30°		<b>891633021</b>
Microfractor WL 170mm 45°	Curved 45°		<b>891634521</b>
Microfractor WL 170 mm 35°	35° S-shaped		<b>891633522</b>
Microfractor WL 170mm 60°	Curved 60°		<b>891636021</b>
Microfractor WL 170mm 60°	60° S-shaped		<b>891636022</b>
Microfractor WL 170mm 80°	Curved 80°		<b>891638021</b>
			
			
			
			
			
			

# COXARTIS

PULSEShifter Microfractor /  
Grasping Forceps



spirit of excellence

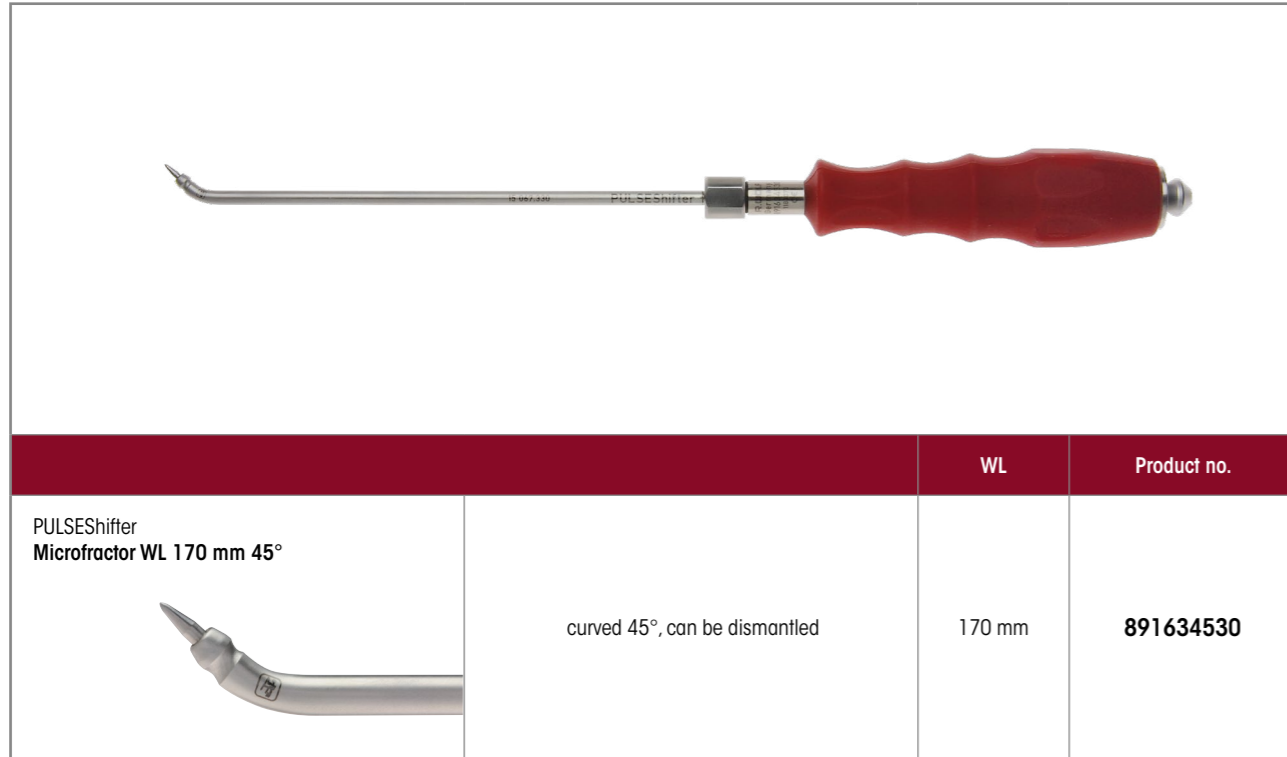

	WL	Product no.
 PULSEShifter Microfractor WL 170 mm 45° curved 45°, can be dismantled	170 mm	<b>891634530</b>

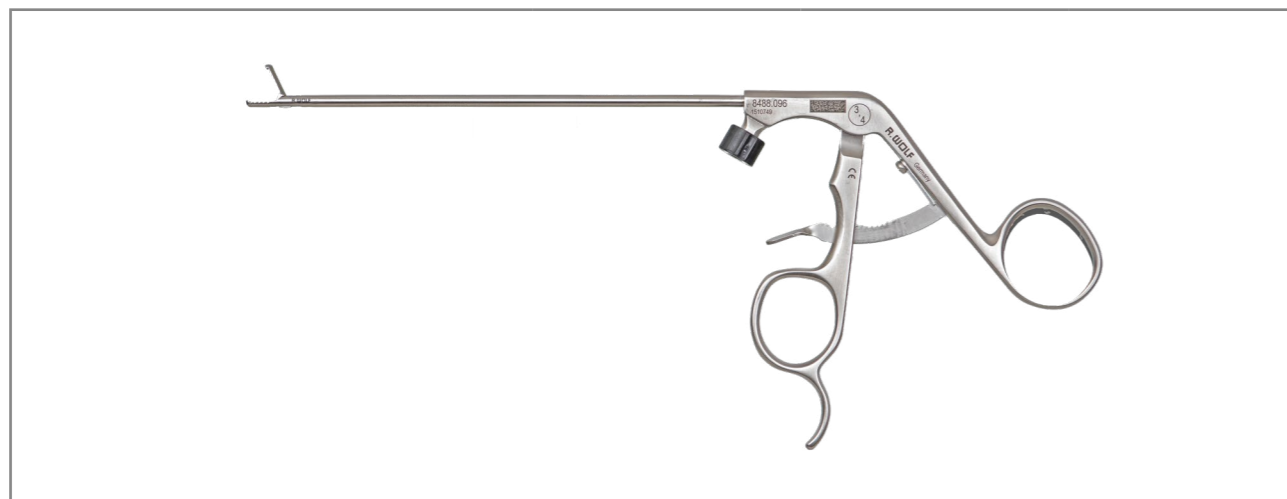

	Ø	WL	Product no.
 Grasping forceps Ø 3.4mm straight jaw section, serrated, handle with lock	3.4 mm	130 mm	<b>8488.096</b>

VI121 || Subject to modifications. Please note that some products may not be available in all countries. For more detailed information, please consult with your contact partner or directly with Richard Wolf GmbH.

VI121 || Subject to modifications. Please note that some products may not be available in all countries. For more detailed information, please consult with your contact partner or directly with Richard Wolf GmbH.









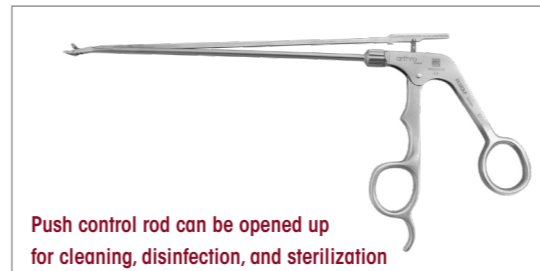
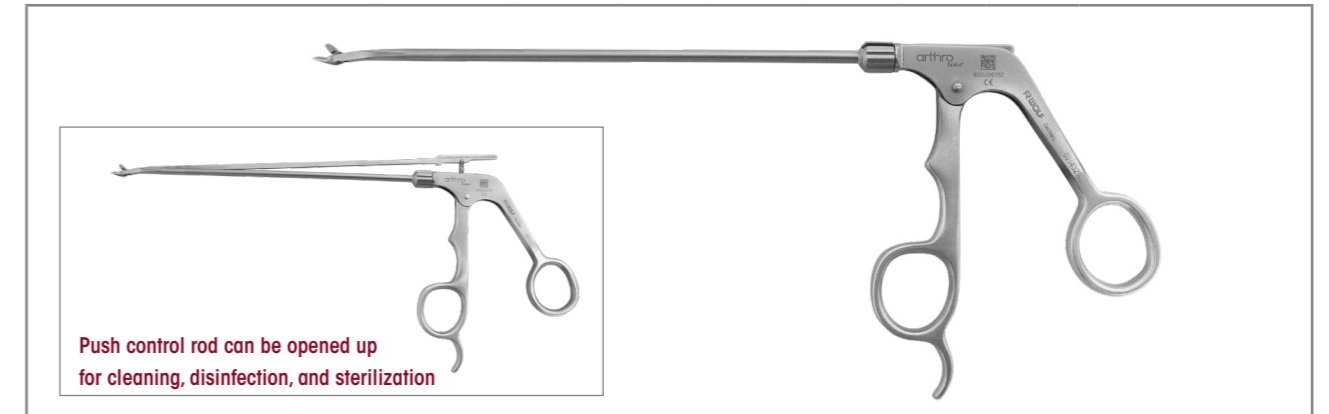

spirit of excellence

# COXARTIS

arthro  
*line* Punch





Push control rod can be opened up  
for cleaning, disinfection, and sterilization

ARTHROline	Jaw section (Height)	WL	Straight	Curved to the left	Curved to the right	Sheath curved upward	Jaws curved upward	Product no.	
 Punch WL 180mm H 1.6mm Sectional view: 	1.6 mm	180 mm	•				•	<b>891432102</b>	
 Punch WL 180mm H 1.6mm Sectional view: 				•			•	<b>891432101</b>	
 Punch WL 180mm H 1.6mm Sectional view: 						•		•	<b>891432103</b>
 Punch WL 180mm H 1.6mm Sectional view: 							•	•	<b>891432122</b>

Hip  
3.7

Hip  
3.7

Spare part and accessory		Product no.
<p><b>Sterile adapter</b> eyecup for replacing the endoscope under sterile conditions, locking mechanism</p>		<p><b>8580.91</b></p>
<p><b>Sealing part for sheath</b></p>		<p><b>89101.0000</b></p>
<p><b>Irrigation ring with 1 stopcock</b></p>		<p><b>150081761</b></p>
<p><b>Irrigation ring with 2 stopcocks</b></p>		<p><b>150081762</b></p>
<p><b>Stopcock bndl cap 3.0mm</b> (PACK= 5 PCS)</p>		<p><b>896.0002</b></p>
<p><b>Mounting ring</b></p>		<p><b>15008.1704</b></p>
<p><b>Spare seal set</b> Comprising: O-ring 9.25X 1.78 VMQ-70 coated (15364396) O-ring 7.65X 1.78 VMQ-70 coated (15364395) (PACK= 5 PCS)</p>		<p><b>15176.142</b></p>
<p><b>Also:</b> <b>O-ring tool</b></p>		<p><b>15106.230</b></p>



**Elbow / Foot**

## Elbow / Foot

4.1

---

**Arthrolution Arthroscopes Overview**

---

4.2

**Telescopes and Sheaths**

---

4.3

**Instruments – Drainage Cannulas / Hook Probes / Guide and Marking Rods /  
ARTHROline Punches / Scissors / Forceps**

---

4.4

**Instruments for Endoscopically Assisted Decompression of the Ulnar Nerve**

---



## Overview

arthro <i>lution</i>			Fingers, toes	Hand	Foot, elbow		Knee, shoulder, hip
Telescope Ø			1.9 mm	2.4 mm	2.7 mm		4.0 mm
Telescopes	30°	PANOVIEW telescope	<b>8860453</b>	<b>8871413</b>	<b>8476.433</b>	<b>8672.422</b>	<b>8880.543</b>
		PANOVIEW wide angle telescope					<b>8885.443</b>
	70°	PANOVIEW telescope					<b>8880.545</b>
		PANOVIEW wide angle telescope					<b>8885.445</b>
Sheath WL			40 mm	60 mm	77.5 mm	145 mm	130 mm
Sheaths	with 1 irrigation stopcock, fixed		<b>891220124</b>	<b>891220132</b>			
	with 2 irrigation stopcocks, fixed						<b>89121.0260</b>
	with 1 irrigation stopcock, rotatable					<b>891241141</b>	
	with 2 irrigation stopcocks, rotatable			<b>891221232</b>	<b>891221241</b>	<b>891241241</b>	<b>89121.1260</b>
	High-Flow with 1 irrigation stopcock, fixed		<b>891220128</b>				
	High-Flow with 2 irrigation stopcocks, rotatable			<b>891221235</b>			<b>89121.1263</b>
	Small-caliber with 2 irrigation stopcocks, rotatable						<b>891221255</b>
Obturator	blunt				<b>891222754</b>		<b>89121.0544</b>
	semi-blunt		<b>891221952</b>	<b>891222452</b>			<b>89121.0542</b>
	conical blunt				<b>891222750</b>	<b>891242750</b>	<b>89121.0540</b>
	sharp					<b>891242761</b>	<b>89121.0640</b>
	conical pointed		<b>891221962</b>	<b>891222462</b>	<b>891222762</b>		
Sealing part for sheath						<b>891040000</b>	

Telescope 2.7 mm  
for Standard Arthroscope

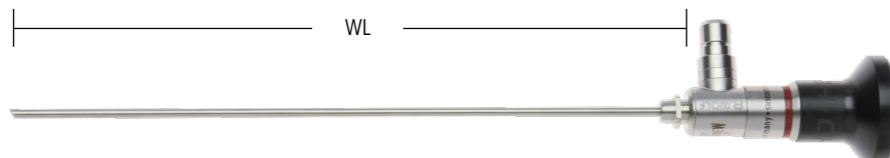

WL

**AUTOCLAVE**  
**134° C / 273° F**

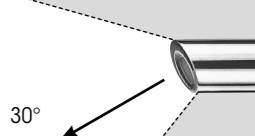
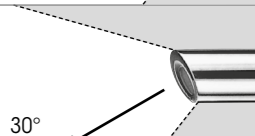
Direction of view		WL	Ø	Product no.
	PANOVIEW PLUS HD telescope 30° Ø 2.7mm WL 103mm	103 mm	2.7 mm	<b>8476.433</b>
	PANOVIEW TELESCOPE 30° Ø 2.7mm WL 182mm	182 mm		<b>8672.422</b>

V1121 || Subject to modifications. Please note that some products may not be available in all countries. For more detailed information, please consult with your contact partner or directly with Richard Wolf GmbH.

Recommended accessories		Product no.
<b>Perf. basket for standard telescope 1</b>	(L x B x H) 297 x 59 x 54 mm	<b>38015</b>
<b>Fiber light cable bndl</b> Comprising: Fiber light cable (80663523), adapter projector side (8095.07) and adapter endoscope side (809509)	Ø 3.5 mm, 2.3 m long	<b>806635231</b>

Telescope 4.0 mm  
for Standard Arthroscope

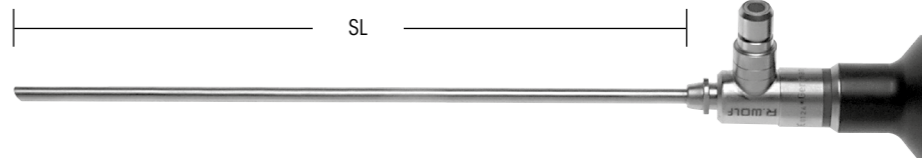

SL

**AUTOCLAVE**  
**134° C / 273° F**

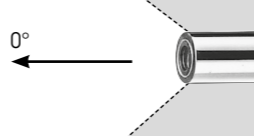
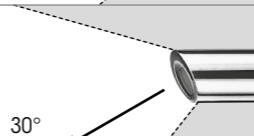
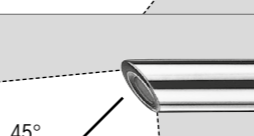
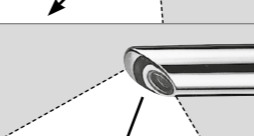
Direction of view		SL	Ø	Product no.
	PANOVIEW telescope 0° Ø 4mm SL 170mm	170 mm	4.0 mm	<b>8880.541</b>
	PANOVIEW telescope 30° Ø 4mm SL 170mm			<b>8880.543</b>
	PANOVIEW telescope 45° Ø 4mm SL 170mm			<b>8880.544</b>
	PANOVIEW telescope 70° Ø 4mm SL 176mm	176 mm		<b>8880.545</b>

V1121 || Subject to modifications. Please note that some products may not be available in all countries. For more detailed information, please consult with your contact partner or directly with Richard Wolf GmbH.

Recommended accessories		Product no.
<b>Perf. basket for standard telescope 1</b>	(L x B x H) 297 x 59 x 54 mm	<b>38015</b>
<b>Fiber light cable bndl</b> Comprising: Fiber light cable (80663523), adapter projector side (8095.07) and adapter endoscope side (809509)	Ø 3.5 mm, 2.3 m long	<b>806635231</b>

**arthro** Sheath for Arthroscope  
*lution*

with automatic click-lock mechanism

						
Sheath for arthroscope OD 4.1 mm				Obturator for arthroscope OD 4.1 mm blunt	Obturator for arthroscope OD 4.1 mm conical blunt	Obturator for arthroscope OD 4.1 mm conical pointed
2 rotatable stopcocks	Outer Ø	WL	Product no.			
•	4.1 mm	77.5 mm	<b>891221241</b>	<b>891222754</b>	<b>891222750</b>	<b>891222762</b>

|| Subject to modifications. Please note that some products may not be available in all countries. For more detailed information, please consult with your contact partner or directly with Richard Wolf GmbH.

|| Subject to modifications. Please note that some products may not be available in all countries. For more detailed information, please consult with your contact partner or directly with Richard Wolf GmbH.

Recommended accessories		Product no.
Sealing part for sheath		<b>89101.0000</b>
Marking rod Ø 4.0 mm, TL 325 mm	conical blunt	<b>8863.75</b>
<b>Spare parts</b>		
Irrigation ring with 1 stopcock		<b>150081761</b>
Irrigation ring with 2 stopcocks		<b>150081762</b>
Stopcock bndl cap 3.0mm (PACK= 5 PCS)		<b>896.0002</b>
Also: Disassembly tool		<b>38310.0001</b>
Mounting ring		<b>15008.1704</b>
Spare seal set (O-rings)	Comprising: O-ring, small (PACK= 5 PCS) O-ring, large (PACK= 5 PCS)	<b>15176.142</b>
Also: O-ring tool (disassembly tool)		<b>15106.230</b>

**arthro** Sheath for Arthroscope  
*lution*

with automatic click-lock mechanism

						
Sheath for arthroscope OD 4.1 mm					Obturator for arthroscope OD 4.1 mm sharp, with slanted tip	Obturator for arthroscope OD 4.1 mm conical blunt
1 rotatable stopcock	2 rotatable stopcocks	Outer Ø	WL	Product no.		
•		4.1 mm	145 mm	<b>891241141</b>	<b>891242761</b>	<b>891242750</b>
	•			<b>891241241</b>		

Recommended accessories		Product no.
Sealing part for sheath		<b>891040000</b>
Marking rod Ø 2.7 mm, TL 250 mm	conical pointed	<b>891242725</b>
<b>Spare parts</b>		
Irrigation ring with 1 stopcock		<b>150081761</b>
Irrigation ring with 2 stopcocks		<b>150081762</b>
Stopcock bndl cap 3.0mm (PACK= 5 PCS)		<b>896.0002</b>
Also: Disassembly tool		<b>38310.0001</b>
Mounting ring		<b>15008.1704</b>
Spare seal set (O-rings)	Comprising: O-ring, small (PACK= 5 PCS) O-ring, large (PACK= 5 PCS)	<b>15176.142</b>
Also: O-ring tool (disassembly tool)		<b>15106.230</b>

## Drainage Cannula Ø 2.3 mm / 3.7 mm

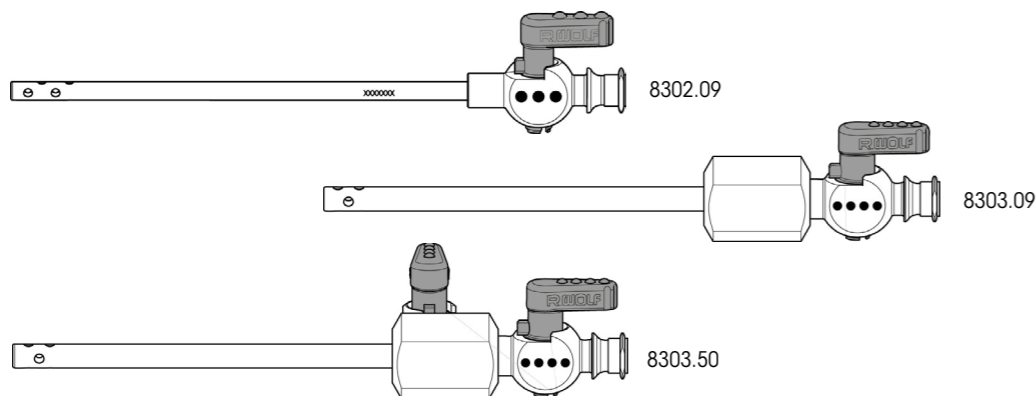

Drainage for cannula and obturator	Capacity	Ø	WL	Product no.
Drainage for cannula Ø 3.2mm WL 80mm with 1 insufflation stopcock	2.3 mm	3.2 mm	80 mm	<b>8302.09</b>
Drainage for cannula Ø 4.5mm WL 71.5mm with 1 insufflation stopcock	3.7 mm	4.5 mm	71.5 mm	<b>8303.09</b>
Drainage for cannula Ø 4.5mm WL 71.5mm with 2 insufflation stopcocks	3.7 mm	4.5 mm	71.5 mm	<b>8303.50</b>
Obturator for cannula OD 3.2mm sharp, with slanted tip		2.3 mm	103 mm	<b>8302.101</b>
Obturator for cannula OD 3.2mm conical blunt tip		2.3 mm	103 mm	<b>8302.11</b>
Obturator for cannula OD 4.5mm sharp, with pyramid-shaped tip		4.5 mm	115 mm	<b>8303.10</b>
Obturator for cannula OD 4.4mm conical blunt tip		4.4 mm	115 mm	<b>8303.11</b>
Also:				
Silicone tube with Luer fitting 886.00	for Drainage for cannula 8302.09		Length 2.0 m	<b>8302.90</b>
Silicone tube with Luer fitting 886.01	for Drainage for cannula 8303.09 / .50			<b>8303.90</b>

|| Subject to modifications. Please note that some products may not be available in all countries. For more detailed information, please consult with your contact partner or directly with Richard Wolf GmbH.

|| Subject to modifications. Please note that some products may not be available in all countries. For more detailed information, please consult with your contact partner or directly with Richard Wolf GmbH.

## Hook Probe / Marking Rod

	H	WL	Product no.
Hook probe WL 115mm H 7mm, graduated	7.0 mm	115 mm	<b>8399.901</b>
Hook probe WL 115mm H 4.5mm, graduated	4.5 mm		<b>8399.95</b>

	Ø	TL	Product no.
Hook probe TL 228 mm SZ 4.4mm	4.4 mm	228 mm	<b>8863.80</b>

	8863.75		
	891242725		

	Ø	TL	Product no.
Marking rod Ø 4.0mm conical blunt	4.0 mm	325 mm	<b>8863.75</b>
Marking rod Ø 2.7mm conical pointed	2.7 mm	250 mm	<b>891242725</b>

arthroline Punch

arthroline Hook Punch / Basket Punch

Elbow / Foot

Elbow / Foot

4.3

4.3



ARTHROline	Jaw section (Height x width)	Cut width	WL	Straight	Curved to the right	Curved to the left	Sheath curved upward	Jaw section curved upward	Product no.		
Punch W 4.6mm H 1.6mm movable jaw section serrated Sectional view:	1.6 x 4.6 mm	3.3 mm	120 mm	•					89140.0105		
Punch W 4.6mm H 1.6mm movable jaw section serrated Sectional view:				•					89140.0102		
Punch W 4. mm H 1.6mm movable jaw section serrated Sectional view:									•	89140.0122	
Punch W 5.5mm H 1.6mm movable jaw section serrated Sectional view:								•		•	89140.0101
Punch W 5.5mm H 1.6mm movable jaw section serrated Sectional view:								•		•	89140.0103

ARTHROline	Jaw section (Height x width)	Cut width	WL	Straight	Jaw section curved upward	Product no.
Hook punch W 3mm H 1.6mm Sectional view:	1.6 x 3.0 mm	1.8 mm	120 mm	•		89140.0205
Hook punch W 3mm H 1.6mm Sectional view:					•	89140.0202
Basket punch W 6.5mm H 2.1mm oval Sectional view:	2.1 x 6.5 mm	4.5 mm		•		89140.0305
Basket punch W 6.5mm H 2.1mm oval Sectional view:					•	89140.0302
Hook punch W 4mm H 2.1mm Sectional view:	2.1 x 4.0 mm	2.1 mm		•		89140.0405
Hook punch W 4 m H 2.1mm Sectional view:					•	89140.0402

V1121 || Subject to modifications. Please note that some products may not be available in all countries. For more detailed information, please consult with your contact partner or directly with Richard Wolf GmbH.

V1121 || Subject to modifications. Please note that some products may not be available in all countries. For more detailed information, please consult with your contact partner or directly with Richard Wolf GmbH.

arthroline Punch / Scissors Punch

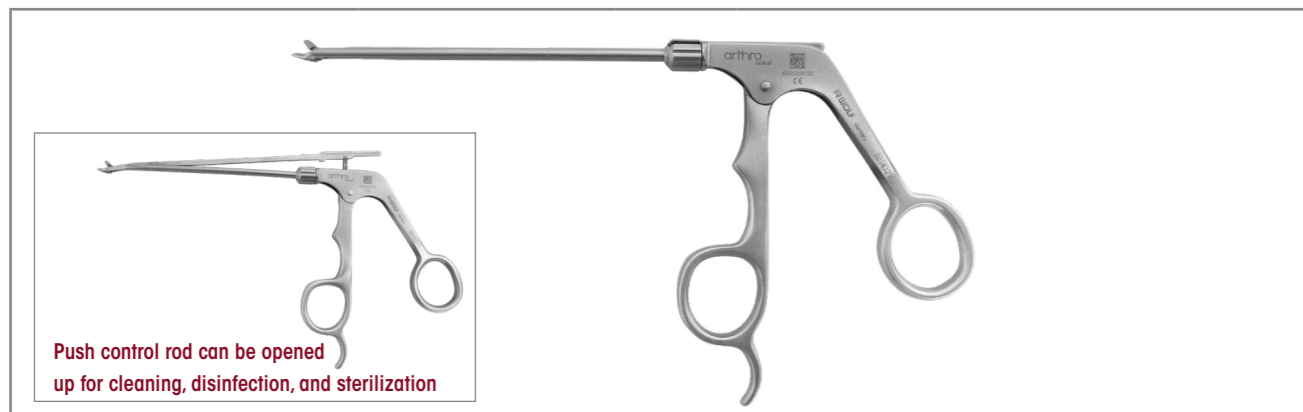

ARTHROline	Jaw section (Height x width)	Cut width	WL	Straight	Retrograde cutting	Jaw section curved upward	Product no.
Scissors punch W 2.4mm H 2.1mm	2.1 x 2.4 mm	0.9 mm	120 mm	•			89140.0505
Sectional view:							
Scissors punch W 2.4mm H 2.1mm						•	89140.0502
Sectional view:							
Punch W 5.7mm H 4mm retrograde left-cutting	4.0 x 5.7 mm	2.3 mm		•	left		89140.0605
Sectional view:							
Punch W 5.7mm H 4mm retrograde right-cutting				•	right		89140.0602
Sectional view:							

VI121 || Subject to modifications. Please note that some products may not be available in all countries. For more detailed information, please consult with your contact partner or directly with Richard Wolf GmbH.

VI121 || Subject to modifications. Please note that some products may not be available in all countries. For more detailed information, please consult with your contact partner or directly with Richard Wolf GmbH.

Suction Punch with Integrated Suction Channel

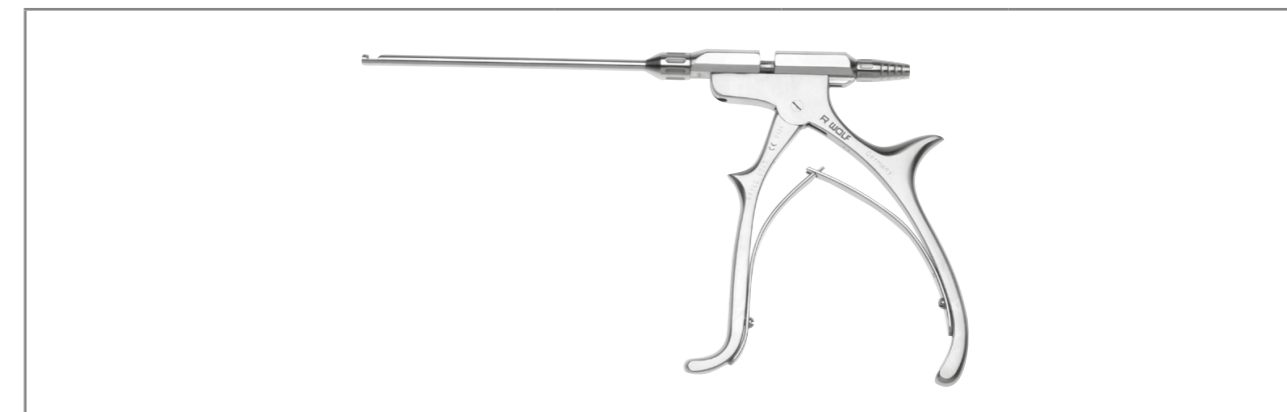

	Ø	WL	Product no.
Suction punch Ø 2.7 mm with integrated suction channel	2.7 mm	110 mm	89140.0027

## Grasping Forceps / Miniature Forceps











	Ø	WL	Product no.
<b>Grasping forceps Ø 3.4mm</b> straight jaw section, serrated, handle with lock	3.4 mm	130 mm	<b>8488.096</b>

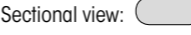

With overload protection and irrigation connector	Sheath Ø	WL	Product no.
<b>Miniature forceps Ø 2.7mm</b> with double spoon jaw	2.7 mm	110 mm	<b>8486.614</b>
<b>Miniature grasping forceps Ø 2.7mm</b>			<b>8486.624</b>
<b>Hook punch Ø 2.7mm</b>			<b>8486.604</b>

## Hook Punch / Punch

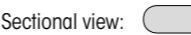

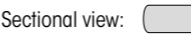

	Sheath Ø	WL	Jaw section (Height x width)	Cut width	Straight	Curved to the left	Curved to the right	Sheath curved 15° upward	Jaw section curved 15° upward	Product no.
<b>Hook punch Ø 3.4mm with shovel</b>  Sectional view: 	3.4 mm	130 mm	3,4 x 3,4 mm	1,6 mm	•					<b>8488.951</b>
						•				<b>8488.952</b>
							•			<b>8488.953</b>
								•		<b>8488.954</b>
<b>Hook punch Ø 3.4mm movable jaw section serrated</b>  Sectional view: 	3.4 mm	130 mm	3,4 x 3,4 mm	1,6 mm	•					<b>8488.02</b>
									•	<b>8488.025</b>
<b>Hook punch Ø 3.4mm serrated</b>  Sectional view: 	3.4 mm	130 mm	1,93 x 3,9 mm	2,7 mm	•					<b>8488.121</b>
									•	<b>8488.063</b>
<b>Hook punch Ø 4.5mm with shovel, serrated</b>  Sectional view: 	4.5 mm	130 mm	1,73 x 5,4 mm	3,4 mm					•	<b>8489.063</b>

VI121 || Subject to modifications. Please note that some products may not be available in all countries. For more detailed information, please consult with your contact partner or directly with Richard Wolf GmbH.

VI121 || Subject to modifications. Please note that some products may not be available in all countries. For more detailed information, please consult with your contact partner or directly with Richard Wolf GmbH.

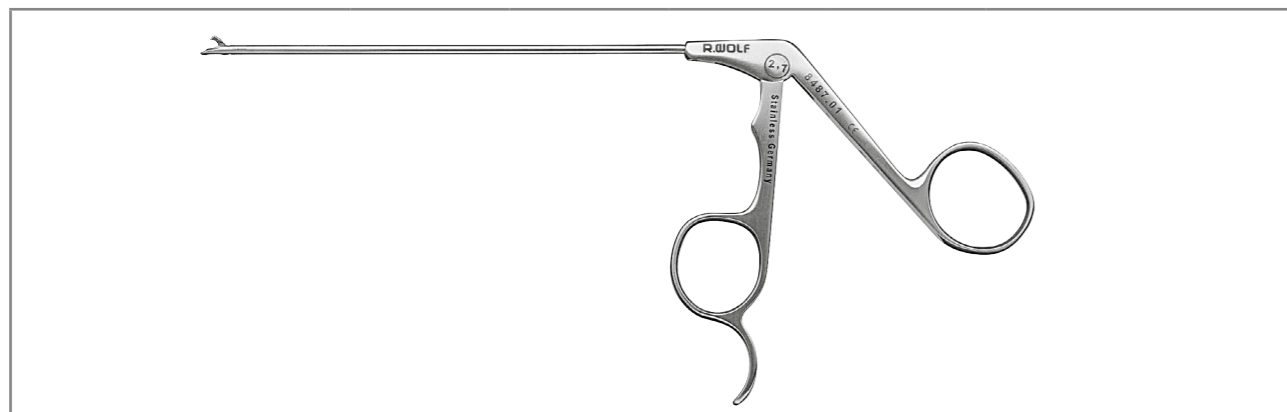
## Punch / Double Spoon Forceps



	Jaw section (Height x width)	Deflection	Cut width	WL	Product no.
<b>Punch Ø 3.4mm</b> front- and side-cutting  Sectional view: <input type="checkbox"/>	2.2 x 5.3 mm	90° left	3.4 mm	130 mm	<b>8404.017</b>
		90° right			<b>8404.018</b>
<b>Hook punch with shovel Ø 3.4mm</b>  Sectional view: <input type="checkbox"/>	2.1 x 2.0 mm	45° left	1.7 mm		<b>8404.71*</b>
		45° right			<b>8404.81*</b>

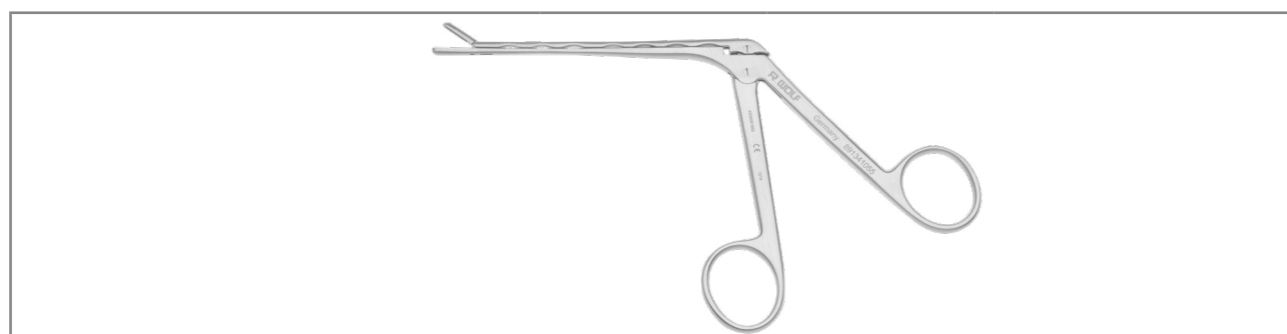

\* particularly suitable for lateral cutting and smoothing

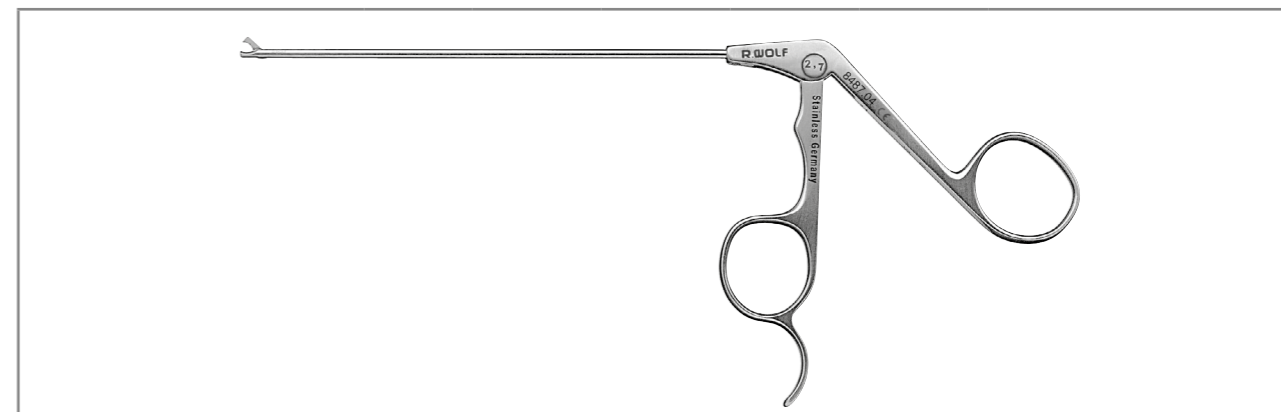

	Jaw section (Height x width)	WL	Product no.
<b>Double spoon forceps W 3.1mm H 4.6mm</b> wave-shaped sheath 	4.6 x 3.1 mm	105 mm	<b>891341055</b>

## Hook Scissors



	WL	Straight jaw section	Straight sheath	Sheath curved to the left	Sheath curved to the right	Product no.
<b>Hook scissors Ø 3.4mm</b>  Sectional view: <input type="checkbox"/>	130 mm	<input type="checkbox"/>	<input type="checkbox"/>	<input type="checkbox"/>	<input type="checkbox"/>	<b>8488.04</b>
		<input type="checkbox"/>	<input type="checkbox"/>	<input checked="" type="checkbox"/>	<input type="checkbox"/>	<b>8488.041</b>
<input type="checkbox"/>		<input type="checkbox"/>	<input type="checkbox"/>	<input checked="" type="checkbox"/>	<input type="checkbox"/>	<b>8488.042</b>
<input type="checkbox"/>		<input type="checkbox"/>	<input type="checkbox"/>	<input type="checkbox"/>	<input checked="" type="checkbox"/>	<b>8488.053</b>
	WL	Jaw section deflection	Straight sheath		Product no.	
	130 mm	45° right	<input checked="" type="checkbox"/>		<b>8404.62</b>	

VI121 || Subject to modifications. Please note that some products may not be available in all countries. For more detailed information, please consult with your contact partner or directly with Richard Wolf GmbH.

VI121 || Subject to modifications. Please note that some products may not be available in all countries. For more detailed information, please consult with your contact partner or directly with Richard Wolf GmbH.



Hand Instruments  
Curette / Microfractor

Elbow / Foot

4.3

			
	Inner-Ø	WL	Product no.
<b>Curette round</b> Ø 3mm WL 65mm one side sharp, curved upward, cutting on traction	3,0 mm	65 mm	<b>891641140</b>
<b>Curette round</b> Ø 4,5mm WL 65mm both sides sharp, angled and curved upwards	4,5 mm		<b>891641155</b>

			
	Deflection	WL	Product no.
<b>Microfractor</b> WL 65mm 30°	Curved 30°	65 mm	<b>891643011</b>
<b>Microfractor</b> WL 65mm 45°	Curved 45°		<b>891644511</b>
<b>Microfractor</b> WL 65mm 60°	Curved 60°		<b>891646011</b>

|| Subject to modifications. Please note that some products may not be available in all countries. For more detailed information, please consult with your contact partner or directly with Richard Wolf GmbH.

|| Subject to modifications. Please note that some products may not be available in all countries. For more detailed information, please consult with your contact partner or directly with Richard Wolf GmbH.

Instruments for  
Endoscopically Assisted Decompression of the Ulnar Nerve  
Optical dissector / telescope

Elbow / Foot

4.4

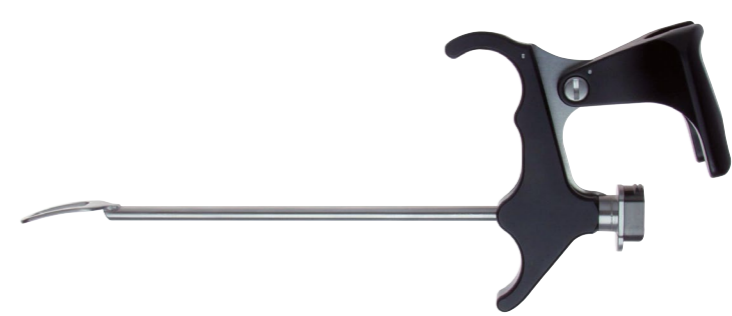
		
	WL	Product no.
<b>Opt. dissector WL 158mm</b> graduated	158 mm	<b>891607001</b>

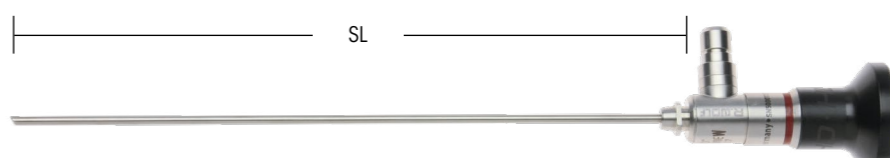
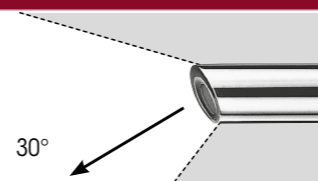
				
<b>AUTOCLAVE</b> <b>134° C / 273° F</b>				
Direction of view		SL	Ø	Product no.
	PANOVIEW telescope 30° Ø 4mm SL 170mm	170 mm	4,0 mm	<b>8880.543</b>

<b>Recommended accessories</b>		Product no.
<b>Perf. basket for standard telescope 1</b>	(L x B x H) 297 x 59 x 54 mm	<b>38015</b>
<b>Fiber light cable bndl</b> Comprising: Fiber light cable (80663523), adapter projector side (8095.07) and adapter endoscope side (809509)	Ø 3,5 mm, 2,3 m long	<b>806635231</b>

# Instruments for Endoscopically Assisted Decompression of the Ulnar Nerve

## Speculum



	WL	Product no.
<b>Speculum w. Removable light rod WL 55 mm</b> comprising: Speculum WL 55mm (8916070021) and light rod (8916070022)	55 mm	<b>891607002</b>



**Hand / Fingers / Toes**

## Hand / Fingers / Toes

5.1

---

**Arthrolution Arthroscopes Overview**

---

5.2

**Telescopes and Sheaths**

---

5.3

**Punches / Forceps / Instruments for Small Joints**

---

5.4

**ENDO-CARTRIS – Instruments for Carpal Tunnel Release**

---

## Overview

arthro <i>lution</i>			Fingers, toes	Hand	Foot, elbow		Knee, shoulder, hip
Telescope Ø			1.9 mm	2.4 mm	2.7 mm		4.0 mm
Telescopes	30°	PANOVIEW telescope	<b>8860453</b>	<b>8871413</b>	<b>8476.433</b>	<b>8672.422</b>	<b>8880.543</b>
		PANOVIEW wide angle telescope					<b>8885.443</b>
	70°	PANOVIEW telescope					<b>8880.545</b>
		PANOVIEW wide angle telescope					<b>8885.445</b>
Sheath WL			40 mm	60 mm	77.5 mm	145 mm	130 mm
Sheaths	with 1 irrigation stopcock, fixed		<b>891220124</b>	<b>891220132</b>			
	with 2 irrigation stopcocks, fixed						<b>89121.0260</b>
	with 1 irrigation stopcock, rotatable					<b>891241141</b>	
	with 2 irrigation stopcocks, rotatable			<b>891221232</b>	<b>891221241</b>	<b>891241241</b>	<b>89121.1260</b>
	High-Flow with 1 irrigation stopcock, fixed		<b>891220128</b>				
	High-Flow with 2 irrigation stopcocks, rotatable			<b>891221235</b>			<b>89121.1263</b>
	Small-caliber with 2 irrigation stopcocks, rotatable						<b>891221255</b>
Obturator	blunt				<b>891222754</b>		<b>89121.0544</b>
	semi-blunt		<b>891221952</b>	<b>891222452</b>			<b>89121.0542</b>
	conical blunt				<b>891222750</b>	<b>891242750</b>	<b>89121.0540</b>
	sharp					<b>891242761</b>	<b>89121.0640</b>
	conical pointed		<b>891221962</b>	<b>891222462</b>	<b>891222762</b>		
Sealing part for sheath						<b>891040000</b>	

Telescope 1.9 mm / 2.4 mm  
for Standard Arthroscope



**AUTOCLAVE**  
**134° C / 273° F**

Direction of view		SL	Ø	Product no.
	PANOVIEW telescope 30° Ø 1.9mm SL 61mm	61 mm	1.9 mm	<b>8860453</b>
	PANOVIEW telescope Ø 2.4mm SL 98mm	98 mm	2.4 mm	<b>8871413</b>

Recommended accessories		Product no.
Perf. basket for standard telescope 1	(L x B x H) 297 x 59 x 54 mm	<b>38015</b>
Fiber light cable bndl Comprising: Fiber light cable (80663523), adapter projector side (8095.07) and adapter endoscope side (809509)	Ø 3.5 mm, 2.3 m long	<b>806635231</b>

|| Subject to modifications. Please note that some products may not be available in all countries. For more detailed information, please consult with your contact partner or directly with Richard Wolf GmbH.

|| Subject to modifications. Please note that some products may not be available in all countries. For more detailed information, please consult with your contact partner or directly with Richard Wolf GmbH.

*arthro* **lution** heath for Arthroscope

with automatic click-lock mechanism



Sheath for arthroscope OD 2.4 mm (telescope Ø 8860453)					Obturator for arthroscope OD 2.4/2.8 mm semi-blunt	Obturator for arthroscope OD 2.4/2.8 mm conical pointed
High-Flow	1 fixed stopcock	Outer Ø	WL	Product no.		
	•	2.4 mm	40 mm	<b>891220124</b>	<b>891221952</b>	<b>891221962</b>
•	•	2.8 mm		<b>891220128</b>		

Spare parts	Product no.
Irrigation ring with 1 stopcock	<b>150081761</b>
Stopcock bndl cap 3.0mm (PACK= 5 PCS)	<b>896.0002</b>
Also: Disassembly tool	<b>38310.0001</b>
Mounting ring	<b>15008.1704</b>
Spare seal set (O-rings)	Comprising: O-ring, small (PACK= 5 PCS) O-ring, large (PACK= 5 PCS) <b>15176.142</b>
Also: Disassembly tool	<b>15106.230</b>

# arthro<sub>lution</sub> Sheath for Arthroscope

with automatic click-lock mechanism

Sheath for arthroscope OD 3.2 / 3.5 mm (telescope Ø 8871413)						Obturator for arthroscope OD 3.2/3.5 mm semi-blunt	Obturator for arthroscope OD 3.2/3.5 mm conical pointed		
High-Flow	1 fixed stopcock	2 rotatable stopcocks	Outer Ø	WL	Product no.				
	•		3.2 mm	60 mm	891220132				
		•			891221232	891222452	891222462		
•		•	3.5 mm		891221235				

Spare parts	Product no.
Irrigation ring with 1 stopcock	150081761
Irrigation ring with 2 stopcocks	150081762
Stopcock bndl cap 3.0mm (PACK= 5 PCS)	896.0002
Also: Disassembly tool	38310.0001
Mounting ring	15008.1704
Spare seal set (O-rings)	Comprising: O-ring, small (PACK= 5 PCS) O-ring, large (PACK= 5 PCS) 15176.142
Also: Disassembly tool	15106.230

|| Subject to modifications. Please note that some products may not be available in all countries. For more detailed information, please consult with your contact partner or directly with Richard Wolf GmbH.

|| Subject to modifications. Please note that some products may not be available in all countries. For more detailed information, please consult with your contact partner or directly with Richard Wolf GmbH.





# Miniature Punch / Forceps

	Ø	WL	Product no.
Hook punch Ø 2 mm	 2.0 mm	65 mm	8486.601
Miniature punch Ø 2.2 mm	 2.2 mm	75 mm	8486.602
Miniature forceps Ø 2 mm with double spoon jaw	 2.0 mm	60 mm	8486.611
Miniature grasping forceps Ø 2 mm	 2.0 mm	60 mm	8486.621
With overload protection and irrigation connector	Sheath Ø	WL	Product no.
Miniature forceps Ø 2.7mm with double spoon jaw	2.7 mm	110 mm	8486.614
Miniature grasping forceps Ø 2.7mm			8486.624
Hook punch Ø 2.7mm			8486.604

Hand  
5.2

Hand  
5.3

## Instruments for Small Joints

			
	Ø	WL	Product no.
<b>Spoon Ø 2.4x1 mm WL 100mm</b> 	2.4 x 1 mm	100 mm	<b>8871.562</b>
<b>Curette round Ø 1.45mm WL 100mm</b> 	1.45 mm		<b>8871.571</b>
<b>Knife with handle WL 100mm</b> 	--		<b>8871.586</b>
<b>Hook probe WL 100mm H2mm</b> H = 2.0 mm 	--		<b>8871.721</b>





**FLUID CONTROL**  
**Irrigation and Suction Pumps**

## FLUID CONTROL Irrigation and Suction Pump

6.1

---

### FLUID CONTROL Arthro 2204

---

## FLUID CONTROL Arthro 2204

Suction and irrigation pump for arthroscopy with automatic tube recognition



### FLUID CONTROL Arthro

is a new pump system for arthroscopy and fully endoscopic spinal surgery. The particular strength of this system lies in a practical combination of high performance and a cost-effective overall concept. The new software and technical enhancements make the **FLUID CONTROL Arthro** ideal for diagnostic and therapeutic arthroscopies.

**FLUID CONTROL Arthro** has already been prepared for integration in core, the digital OR from Richard Wolf.

## FLUID CONTROL Arthro 2204

Suction and irrigation pump for arthroscopy with automatic tube recognition

**Arthro/spine suc./irrig.pump bndl**

for arthroscopy ..... **22040011**

Comprising:

1 x arthro/spine suc./irrig.pump 200mmHG.....	2204001
1 x irrigation tube set spike .....	8171223
1 x tube set for vacuum, incl. filter .....	2206207
1 x protection filter for gas filtration .....	4171.121
1 x power cable .....	2440.03

**Arthro/spine suc./irrig.pump bndl**

with Spine Mode software module for arthroscopy and fully endoscopic spinal surgery ..... **22040012**

Comprising:

1 x arthro/spine suc./irrig.pump 200mmHG .....	2204001
1 x Spine mode software module .....	2204101
1 x irrigation tube set spike .....	8171223
1 x tube set for vacuum, incl. filter .....	2206207
1 x protection filter for gas filtration .....	4171.121
1 x power cable .....	2440.03

Recommended accessories		Product no.
Footswitch		2204901

V1121 || Subject to modifications. Please note that some products may not be available in all countries. For more detailed information, please consult with your contact partner or directly with Richard Wolf GmbH.

V1121 || Subject to modifications. Please note that some products may not be available in all countries. For more detailed information, please consult with your contact partner or directly with Richard Wolf GmbH.

## FLUID CONTROL Arthro 2204

Irrigation and suction pump for arthroscopy with automatic tube recognition

**Day-patient tube set**

**From two interventions/patients per day:**

Use the **day-patient tube set**, which comprises a day tube and a connected patient tube. The day tube remains in the pump throughout the day, while the patient tube has to be changed for each operation. The irrigation fluid bag can remain on the pump until it has been completely

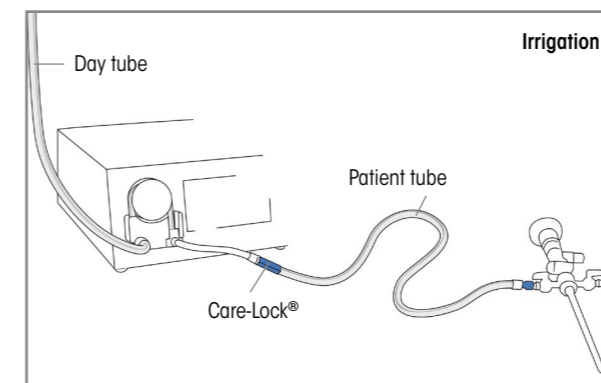

used up. **This significantly reduces the amount of waste and cuts costs.**

**Further tube versions are available to complement the system.**

**Note:** The use of the day-patient tube set has not been approved for the Spine Mode application.

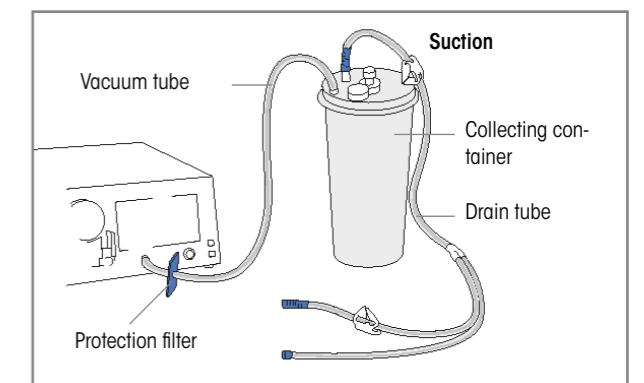

Irrigation			Product no.
<b>Accessories – reusable</b>	<b>Irrigation tube set spike</b>	With Luer-Lock connection, autoclavable, incl. 10 spare membranes, reusable for 20 reprocessing cycles	<b>8171223</b>
<b>Accessories – disposable</b>	<b>Irrigation tube set with spike L 3 m</b>	(PACK= 10 PCS), with Luer-Lock connection, sterile, disposable product	<b>4171223</b>
	<b>Irrigation tube set CARE-LOCK, L 3 m</b>	(PACK= 10 PCS), sterile, disposable product	<b>4171224</b>
	<b>Day irrigation tube set</b>	(PACK= 10 PCS), with piercing spike, sterile disposable product, PVC	<b>4171226</b>
	<b>Patient irrigation tube set L 3m</b>	(PACK= 10 PCS), with Luer-Lock connection, sterile, disposable product, PVC	<b>4171227</b>
<i>Note: Day tube and patient tube can only be used together. A new patient tube is required for each patient – the day tube can be used for up to 20 patients.</i>			

Suction			Product no.
<b>Accessories – reusable</b>	<b>Tube set for vacuum, incl. filter</b>	with integrated hygiene filter, PACK= 10 PCS, service life of 30 days (connected to irrigation pump)	<b>2206207</b>
<b>Accessories – disposable</b>	<b>Secretion container, 2 L</b>	2 liters, no lid	<b>8170.6551</b>
	<b>Secretion container, 2.5 L</b>	2.5 liters	<b>41706566</b>
	<b>Tube set for suction (with 2 ports)</b>	sterile, disposable, (PACK= 10 PCS) for connecting instruments to collecting container	<b>T0503-01</b>

## Technical Data

### FLUID CONTROL Arthro 2204

<b>Arthro/spine suc./irrig.pump 200mmHG</b>	<b>2204001</b>
Power supply connection	100–240 VAC, 50/60 Hz
Power consumption	118 VA
Protection class to VDE 0750 / IEC 601	1
Classification	CF
Pressure range (infinite preselection)	15–200 mmHg
Delivery rate (can be preselected in 50 ml increments)	0–2 l/min
Dimensions (W x H x D)	300 x 157 x 436 mm
Weight	8.3 kg
Interfaces	USB / CAN bus (core) service interface



## Universal Motor Systems

## Universal Motor Systems

7.1 **PowerSpeed AS1** Universal Motor System

7.2 **Power Stick M5/3 and M5/0** Motor Handpieces for PowerSpeed AS1

7.3 **Reusable Shaver Blades and Burrs**  
for Power Stick M5/3, Power Stick M5/0, and Micro Stick S1

7.4 **Disposable Shaver Blades and Burrs**  
for Power Stick M5/3, Power Stick M5/0, and Micro Stick S1

# PowerSpeed AS1

## Universal motor system



The PowerSpeed AS1 motor system has been developed for universal use and provides extremely comfortable and ergonomic handling.

Quick and powerful resecting, drilling, burring, or sawing – anything is possible.

- Wide range of disposable and reusable shaver blades and burrs
- Intelligent tool detection via RFID chip
- Touchscreen makes user interface easy to operate
- Communication interface with FLUID CONTROL ArthroPump 2204 and **core nova**
- Universal use of all current Richard Wolf motor handpieces
- Wireless footswitch
- Universal use in spinal surgery, bronchoscopy, and arthroscopy



## PowerSpeed AS1

Universal motor system



### MOTOR CONTROL UNIT 2305

Power supply connection 50/60 Hz, 100–240 V includes power supply cable,

CAN bus connection cable, and packaging ..... **2305001**

Universal motor system for orthopedics and spinal surgery, for connecting motor handpieces when working with shaver and high-speed applications, and for connecting the Power Drill M1.

Recommended accessories	Product no.
Remote footswitch 2 pedals+2 buttons	 <b>2305100</b>
Also:	
Power supply unit 6600403	<b>FW8002M/08</b>
Backup cable, WL 3m	<b>2305300</b>

MOTOR CONTROL UNIT 2305	2305001
Power supply connection	100–240 VAC, 50/60 Hz
Power consumption	250 VA
Electromagnetic compatibility EMC to	IEC / EN 60601-1-2
Medical Devices Directive 93/42/EEC	Class IIa
Protection class to IEC / EN 60601-1 (ANSI / AAMI ES60601-1 / CAN CSA-C22.2 No. 60601-1)	I
Protection against electric shock	Type BF applied part
Degree of protection against the ingress of liquids	IP 20 (not protected)
Operating mode	Continuous operation
Degree of protection in the presence of flammable mixtures	Device is not protected against explosions (do not operate device in areas where there is a danger of explosion)
Weight	9.2 kg
Dimensions (W x H x D)	300 x 159.5 x 404 mm

## Power Stick M5/3

## Power Stick M5/0

Motor Handpieces for PowerSpeed AS1

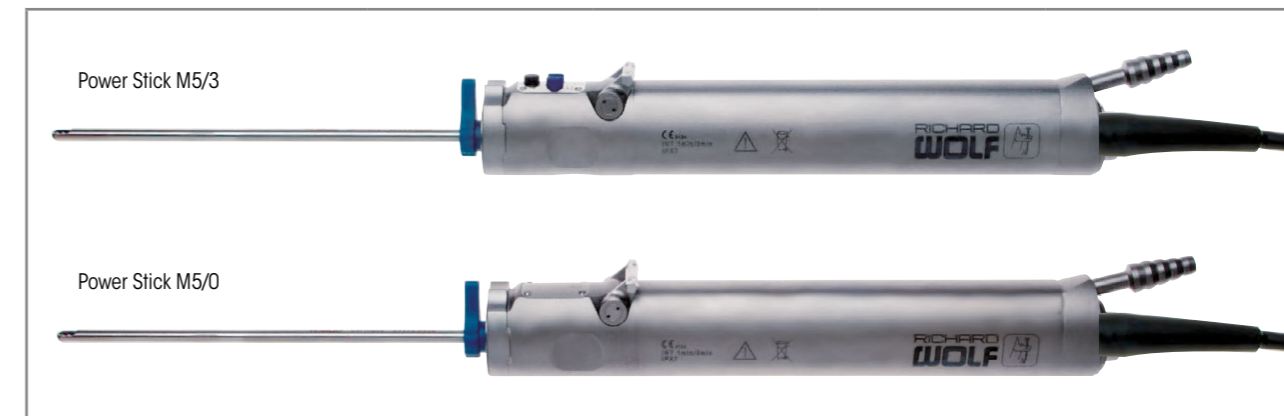

For driving rotation tools with three function buttons			Ø for shaver tools	Product no.
Power Stick M5/3 Motor handpiece max. 16000 rpm	with fixed connection cable, 3.0 m	Operated via button cluster and footswitch	2–6.5 mm	<b>8995500031</b>
	with removable connection cable, 3.0 m			<b>89955.0003</b>
For driving rotation tools			Ø for shaver tools	Product no.
Power Stick M5/0 Motor handpiece max. 16000 rpm	with fixed connection cable, 3.0 m	Operated via footswitch	2–6.5 mm	<b>8995500001</b>
	with removable connection cable, 3.0 m			<b>89955.0000</b>

- Handpieces with/without control panel
- Up to 16,000 rpm
- For tools with a diameter of 2.5–6.5 mm
- Oscillation frequency of up to 4 Hz

Recommended accessories	Product no.
Connection cable, WL 3m	3.0 m long <b>8564.851</b>
Container (wxhxd) 400x60x200mm	Holds: Instruments, for sterilization (steam and low-temperature), storage and transport, with instrument mat, inner dimensions (wxhxd): 400x57x200mm, outer dimensions (BxHxT): 466x77x266mm <b>33022</b>

V1121 || Subject to modifications. Please note that some products may not be available in all countries. For more detailed information, please consult with your contact partner or directly with Richard Wolf GmbH.

V1121 || Subject to modifications. Please note that some products may not be available in all countries. For more detailed information, please consult with your contact partner or directly with Richard Wolf GmbH.

## Micro Stick S1

Motor handpiece for PowerSpeed AS1

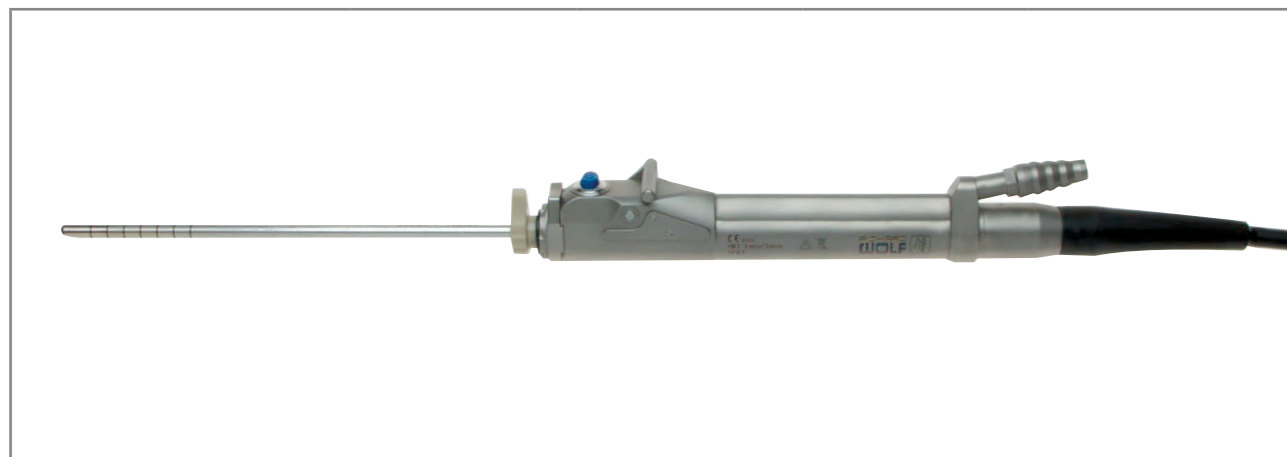

For driving rotation tools with one function button			Ø for shaver tools	Product no.
Motor handpiece max. 3000 rpm	with fixed connection cable, 3.0 m	Operated via the ON/OFF button	2–3.5 mm	<b>899510001</b>

- Mini motor handpiece for exceptional precision in small joints
- Up to 3,000 rpm
- Practical range of accessories
- For shaver tools with a diameter of 2–3.5 mm

Recommended accessories		Product no.
Container (wxhxd) 400x60x200mm	Holds: Instruments, for sterilization (steam and low-temperature), storage and transport, with instrument mat, inner dimensions (wxhxd): 400x57x200mm, outer dimensions (BxHxT): 466x77x266mm	<b>33022</b>

|| Subject to modifications. Please note that some products may not be available in all countries. For more detailed information, please consult with your contact partner or directly with Richard Wolf GmbH.

|| Subject to modifications. Please note that some products may not be available in all countries. For more detailed information, please consult with your contact partner or directly with Richard Wolf GmbH.

## Reusable Shaver Blades and Burrs

for Power Stick M5/3 and M5/0 motor handpiece, large interface

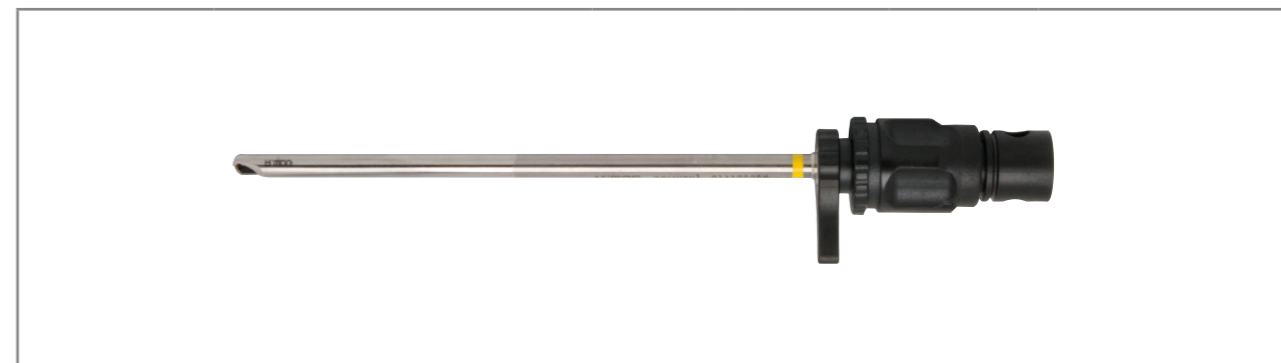

	Reusable (1 PC)	Color coding	WL	Ø	Product no.
	Resector smooth Ø 3.5mm	canary yellow	130 mm	3.5 mm	<b>899750003</b>
	Resector smooth Ø 4.5mm			4.5 mm	<b>899750004</b>
	Resector smooth Ø 5.5mm			5.5 mm	<b>899750005</b>
	Resector toothed Ø 2mm	ocher	45 mm	2.0 mm	<b>89975.0032</b>
	Resector toothed Ø 2.7mm		80 mm	2.7 mm	<b>899750132</b>
	Resector toothed Ø 3.5mm		130 mm	3.5 mm	<b>89975.0033</b>
	Resector toothed Ø 4.5mm			4.5 mm	<b>89975.0034</b>
	Resector toothed Ø 5.5mm			5.5 mm	<b>89975.0035</b>
	Resector aggress Ø 2.7mm	red	80 mm	2.7 mm	<b>899750332</b>
	Resector aggress Ø 3.7mm		130 mm	3.7 mm	<b>89975.0333</b>
	Resector aggress Ø 4.7mm			4.7 mm	<b>89975.0334</b>
	Resector aggress Ø 5.85mm			5.85 mm	<b>899750335</b>
	Resector oval Ø 3.5mm	white	130 mm	3.5 mm	<b>89975.0113</b>
	Resector oval Ø 4.5mm			4.5 mm	<b>89975.0114</b>
	Resector oval Ø 5.5mm			5.5 mm	<b>89975.0115</b>

|| Subject to modifications. Please note that some products may not be available in all countries. For more detailed information, please consult with your contact partner or directly with Richard Wolf GmbH.

|| Subject to modifications. Please note that some products may not be available in all countries. For more detailed information, please consult with your contact partner or directly with Richard Wolf GmbH.

### Reusable Shaver Blades and Burrs

for Power Stick M5/3 and M5/0 motor handpiece, large interface



	Reusable (1 PC)	Color coding	WL	Ø	Product no.
	Resector convex curved smooth Ø 3.5mm	canary yellow	130 mm	3.5 mm	<b>89975.0253</b>
	Resector convex curved smooth Ø 4.5mm			4.5 mm	<b>89975.0254</b>
	Resector concave curved smooth Ø 3.5mm	canary yellow	130 mm	3.5 mm	<b>89975.0263</b>
	Resector concave curved smooth Ø 4.5mm			4.5 mm	<b>89975.0264</b>
	End cutter Ø 3.5mm	black	130 mm	3.5 mm	<b>89975.0493</b>
	End cutter Ø 4.5mm			4.5 mm	<b>89975.0494</b>
	Burr round Ø 3mm	gulf blue	80 mm	3.0 mm	<b>89975.0503</b>
	Burr round Ø 4.5mm		130 mm	4.5 mm	<b>89975.0504</b>
	Burr round Ø 5.5mm		5.5 mm	<b>89975.0505</b>	
with lateral protection					
	Burr round Ø 6mm	royal blue	130 mm	6.0 mm	<b>89975.0516</b>
	Acromionizer Ø 3.5mm	purple	130 mm	3.5 mm	<b>89975.0553</b>
	Acromionizer Ø 4.5mm			4.5 mm	<b>89975.0554</b>
	Acromionizer Ø 5.5mm			5.5 mm	<b>89975.0555</b>
	Acromionizer Ø 6.5mm			6.5 mm	<b>89975.0556</b>
with lateral protection					

VI121 || Subject to modifications. Please note that some products may not be available in all countries. For more detailed information, please consult with your contact partner or directly with Richard Wolf GmbH.

VI121 || Subject to modifications. Please note that some products may not be available in all countries. For more detailed information, please consult with your contact partner or directly with Richard Wolf GmbH.

### Reusable Shaver Blades and Burrs

for Power Stick M5/3 and M5/0 motor handpiece for hip arthroscopy



	Reusable (1 PC)	Color coding	WL	Ø	Product no.
	Resector toothed Ø 4.7mm	ocher	200 mm	4.7 mm	<b>899732004*</b>
	Resector aggress Ø 4.7mm	red	200 mm	4.7 mm	<b>899732334*</b>
	Resector convex curved aggress Ø 4.7mm	red	200 mm	4.7 mm	<b>899732254</b>
	Resector convex curved aggress Ø 4.7mm	red	200 mm	4.7 mm	<b>899732264</b>
	Burr round Ø 5.5mm	gulf blue	200 mm	5.5 mm	<b>899732504</b>
with 2 mm retracted lateral protection					
	Acromionizer Ø 5.5mm	purple	200 mm	5.5 mm	<b>899732555</b>
with 2 mm retracted lateral protection					

\* Shaver blade with distal guide hole for guide wire Ø 2.0 mm

## Reusable Shaver Blades and Burrs

for Micro Stick S1,  
small interface



	Reusable (1 pc)	Color coding	WL	Ø	Product no.
	Resector toothed Ø 2mm	ocher	45 mm	2.0 mm	<b>89971.0032</b>
	Resector toothed Ø 3.5mm		130 mm	3.5 mm	<b>89971.0033</b>
	Resector toothed Ø 4.5mm			4.5 mm	<b>89971.0034</b>
	Resector toothed Ø 2.5mm		80 mm	2.5 mm	<b>899710132</b>
	Resector aggress Ø 2.7mm	red	80 mm	2.7 mm	<b>899710332</b>
	Resector oval Ø 3.5mm	white	130 mm	3.5 mm	<b>89971.0113</b>
	Resector oval Ø 4.5mm			4.5 mm	<b>89971.0114</b>
	Resector convex curved smooth Ø 4.5mm	canary yellow	130 mm	4.5 mm	<b>89971.0254</b>
	Resector concave curved smooth Ø 4.5mm	canary yellow	130 mm	4.5 mm	<b>89971.0264</b>
	Burr round Ø 3mm	gulf blue	80	3.0 mm	<b>89971.0503</b>

|| Subject to modifications. Please note that some products may not be available in all countries. For more detailed information, please consult with your contact partner or directly with Richard Wolf GmbH.

|| Subject to modifications. Please note that some products may not be available in all countries. For more detailed information, please consult with your contact partner or directly with Richard Wolf GmbH.

## Disposable Shaver Blades and Burrs

for Power Stick M5/3 and M5/0 motor handpiece



	Disposable (5 PCS, in individual sterile packaging)	Color coding	WL	Ø	Product no.
	Resector smooth Ø 3.5mm	canary yellow	130 mm	3.5 mm	<b>49975.0003</b>
	Resector smooth Ø 4.5mm			4.5 mm	<b>49975.0004</b>
	Resector smooth Ø 5.5mm			5.5 mm	<b>49975.0005</b>
	Resector toothed Ø 3.5mm	ocher	130 mm	3.5 mm	<b>49975.0033</b>
	Resector toothed Ø 4.5mm			4.5 mm	<b>49975.0034</b>
	Resector toothed Ø 5.5mm			5.5 mm	<b>49975.0035</b>
	Resector aggress Ø 2.5mm	red	80 mm	2.5 mm	<b>499750332</b>
	Resector aggress Ø 3.5mm		130 mm	3.5 mm	<b>49975.0333</b>
	Resector aggress Ø 4.5mm			4.5 mm	<b>49975.0334</b>
	Resector aggress Ø 5.5mm			5.5 mm	<b>49975.0335</b>
	Resector oval Ø 3.5mm	white	130 mm	3.5 mm	<b>49975.0113</b>
	Resector oval Ø 4.5mm			4.5 mm	<b>49975.0114</b>
	Resector oval Ø 5.5mm			5.5 mm	<b>49975.0115</b>

## Disposable Shaver Blades and Burrs

for Power Stick M5/3 and M5/0 shaver handle



	Disposable (5 PCS, in individual sterile packaging)	Color coding	WL	Ø	Product no.
	Resector convex curved smooth Ø 3.5mm	canary yellow	130 mm	3.5 mm	<b>49975.0253</b>
	Resector convex curved smooth Ø 4.5mm			4.5 mm	<b>49975.0254</b>
	Resector convex curved smooth Ø 5.5mm			5.5 mm	<b>49975.0255</b>
	Resector concave curved smooth Ø 3.5mm	canary yellow	130 mm	3.5 mm	<b>49975.0263</b>
	Resector concave curved smooth Ø 4.5mm			4.5 mm	<b>49975.0264</b>
	Resector concave curved smooth Ø 5.5mm			5.5 mm	<b>49975.0265</b>
	End cutter Ø4.5 mm	black	130 mm	4.5 mm	<b>49975.0494</b>
	Burr round Ø 4.5mm	gulf blue	130 mm	4.5 mm	<b>49975.0504</b>
	Burr round Ø 6mm	gulf blue	130 mm	6.0 mm	<b>49975.0516</b>
	Acromionizer Ø 3.5mm	purple	130 mm	3.5 mm	<b>49975.0553</b>
	Acromionizer Ø 4.5mm			4.5 mm	<b>49975.0554</b>
	Acromionizer Ø 5.5mm			5.5 mm	<b>49975.0555</b>
	Acromionizer Ø 6.5mm			6.5 mm	<b>49975.0556</b>

|| Subject to modifications. Please note that some products may not be available in all countries. For more detailed information, please consult with your contact partner or directly with Richard Wolf GmbH.

|| Subject to modifications. Please note that some products may not be available in all countries. For more detailed information, please consult with your contact partner or directly with Richard Wolf GmbH.

## Disposable Shaver Blades and Burrs

for Power Stick M5/3 and M5/0 shaver handle

for hip arthroscopy



	Disposable (5 PCS, in individual sterile packaging)	Color coding	WL	Ø	Product no.
	Resector curved universal Ø 4.5mm	gray	160 mm	4.5 mm	<b>499732274</b>
	Resector universal Ø 4.5mm	gray	160 mm	4.5 mm	<b>499732344</b>
	Burr oval Ø 5.5mm	purple	160 mm	5.5 mm	<b>499732565</b>





|| Subject to modifications. Please note that some products may not be available in all countries. For more detailed information, please consult with your contact partner or directly with Richard Wolf GmbH.

|| Subject to modifications. Please note that some products may not be available in all countries. For more detailed information, please consult with your contact partner or directly with Richard Wolf GmbH.

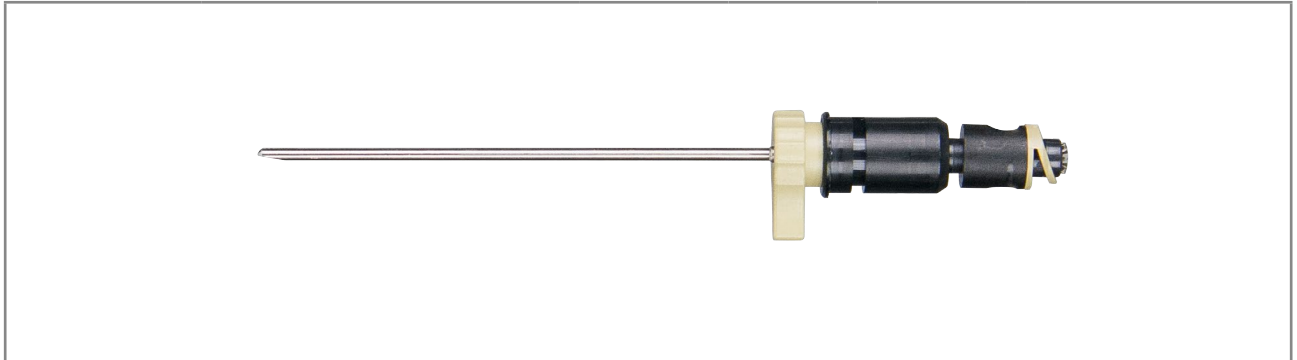
## Disposable Shaver Blades and Burrs

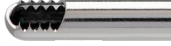
for Micro Stick S1



	Disposable (5 PCS, in individual sterile packaging)	Color coding	WL	Ø	Product no.
	<b>Resector toothed Ø 2mm</b>	ocher	45 mm	2.0 mm	<b>49971.0032</b>
	<b>Resector toothed Ø 3.5mm</b>		130 mm	3.5 mm	<b>49971.0033</b>
	<b>Resector aggress Ø 2.5mm</b>	red	80 mm	2.5 mm	<b>499710332</b>
	<b>Resector oval Ø 3.5mm</b>	white	130 mm	3.5 mm	<b>49971.0113</b>
 with lateral protection	<b>Burr round Ø 3mm</b>	gulf blue	130 mm	3.0 mm	<b>49971.0503</b>
 with lateral protection	<b>Burr oval Ø 3.5mm</b>	canary yellow	130 mm	3.5 mm	<b>49971.0553</b>



## Battery-powered tools bee-system II

for all orthopaedic indications  
and large bone surgery

## Battery-powered tools bee-system II

---

8.1 **bee-system II** Drill & Ream machine / Drill machine standard

---

8.2 **bee-system II** Oscillating Reaming machine / saws

---

8.3 **Powerpack / Battery charger / Accessories**

---



# bee-system II

## Battery-powered tools

for all orthopaedic indications and large bone surgery

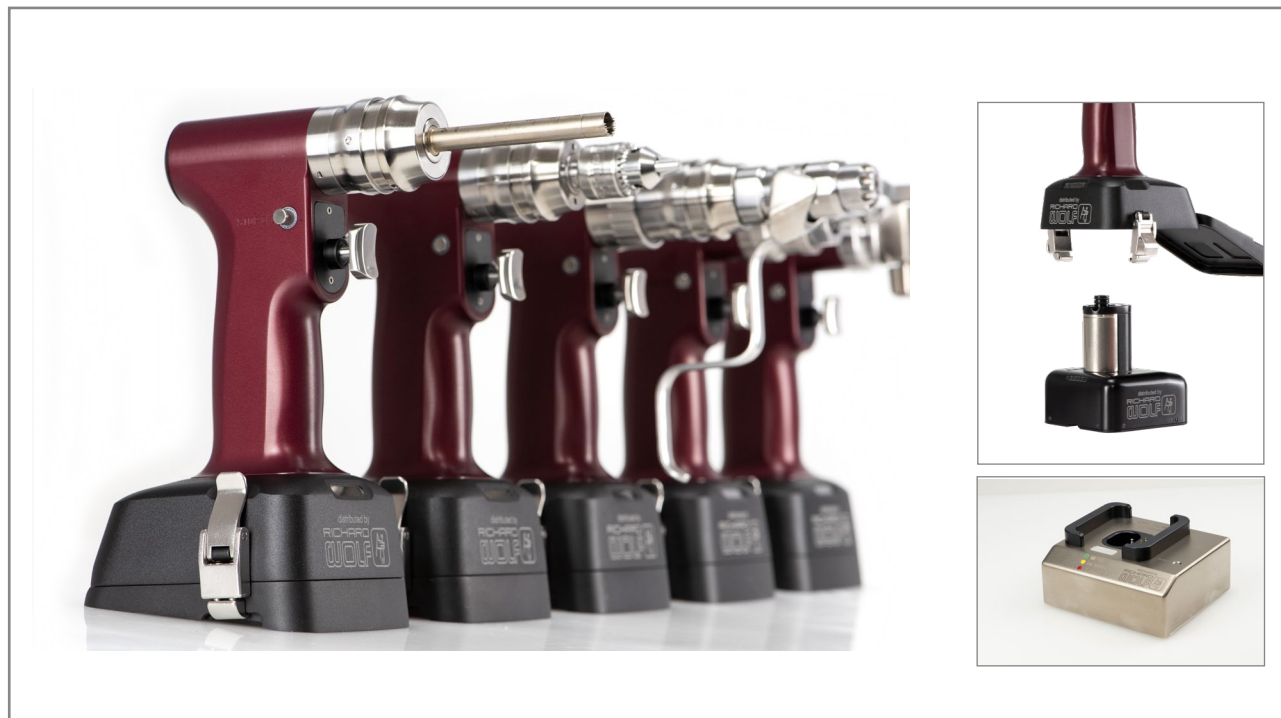

### Drill & Ream machine

The new bee-system II universal Drill and Ream handpiece for all orthopaedic indications and large bone surgery. Drill & Ream machine with Right / Left (CW and CCW) rotation lever for oscillating mode on / off and trigger for manual speed regulation with ring for switch Drill and Ream mode.

- With Right / Left (forward / backward rotation)
- Lock position
- Oscillating mode on / off
- Continuously adjustable rotation speed
- Drill with 2 speed ranges, switch to change from Drill to Ream mode

### Drill machine standard

The new bee-system II small handpiece for all drill attachments incl. Kirschner pin driver with continuously adjustable rotation speed.

- With Right / Left (CW / CCW) rotation
- Lock position
- Continuously adjustable rotation speed

### Oscillating reaming machine

The new Oscillating Reaming machine for use in anterior cruciate ligament reconstruction.

- Lock position
- Continuously adjustable oscillation speed

### Oscillating saws

Oscillating saws are available in two versions:

Oscillating saw, 4° (lateral movement) for Synthes / AO saw blades and oscillating saw for Stryker sawblades.

Sagittal oscillating saw in bone surgery:

- With rotatable saw blade clamp in 45° steps (8 positions)
- Manual speed adjustment and oscillating mode
- Shift lever for operating in two different speeds
- With AO-Synthes and Stryker connection of the saw blade

### Sternum saw

Sternum saw with protection sleeve and keyless chuck with continuously adjustable rotation speed and switch lever from Step I to II. Basic model can be used as reciprocating saw.

Rotate the attachment / chuck to the desired position. Locking always at 90°.

- Precise cutting guide with good visibility conditions
- Easy clamping of sawblade (no tools required)
- Use of saw blades with Stryker adaption
- Attachment of protection sleeve in 4 different positions possible (locking at 90°)
- Basic model to be used as reciprocating

### Powerpack and battery charger

- 1 powerpack for all machines
- 3 chargers with charge status display

## bee-system II

### Drill and ream machine

for all orthopaedic indications and large bone surgery



		Product no.
<b>beesystemII drill &amp; ream machine</b>	with Right / Left (CW and CCW) rotation lever for oscillating mode on / off and trigger for manual speed regulation with ring for switch Drill and Ream mode	<b>F-31-100-00</b>
Accessories see page Ortho132-Ortho133 / Ortho142		

- With Right / Left (forward / backward rotation)
- Lock position
- Oscillating mode on / off
- Continuously adjustable rotation speed
- Drill with 2 speed ranges, switch to change from Drill to Ream mode

Technical data F-31-100-00	
Handpiece dimensions (without attachment)	162 x 93 x 198 mm
Weight of handpiece with powerpack	1850 g
Continuously adjustable rotation speed	0 - 1000 rpm (drill mode) / 0 - 250 rpm (ream mode)
Cannulation	Ø 4.3 mm
Protection class	B, EN 60601-1
Power supply	Internal battery

## bee-system II

### Drill machine standard

for all drill attachments incl. Kirschner pin driver with continuously adjustable rotation speed



		Product no.
<b>beesystemII drill machine standard</b>		<b>F-31-150-00</b>
Accessories see page Ortho132-Ortho133 / Ortho142		

- With Right / Left (CW / CCW) rotation
- Lock position
- Continuously adjustable rotation speed









Technical data F-31-150-00	
Handpiece dimensions (without attachment)	137 x 93 x 197 mm
Weight of handpiece with powerpack	1660 g
Continuously adjustable rotation speed	0 - 1000 rpm
Cannulation	Ø 4.3 mm
Protection class	B, EN 60601-1
Power supply	Internal battery

VI121 || Subject to modifications. Please note that some products may not be available in all countries. For more detailed information, please consult with your contact partner or directly with Richard Wolf GmbH.

VI121 || Subject to modifications. Please note that some products may not be available in all countries. For more detailed information, please consult with your contact partner or directly with Richard Wolf GmbH.

# bee-system II

Drill & ream and drill machines standard  
Accessories

Accessories		for Drill & Ream F-31-100-00	for Drill standard F-31-150-00	Product no.
 Wire/pin driver (for drill/ream)(Ø1-4mm)	for use with K-wires with: Ø 1.0 mm (Drill mode) to Ø 4.0 mm (Ream mode)	•		F-30-100-10
 Wire/pin driver (for standard)(Ø 1-4mm)	for use with K-wires with: Ø 1.0 mm (Drill mode) to Ø 4.0 mm (Ream mode)		•	F-30-100-15
 Extension guide for wire/pin driver		•	•	F-30-100-19
 Adapter for drill guide, radiolucent		•	•	F-30-100-25
 AO-connector small	for drilling and milling, cannulated, Ø 2,5mm	•	•	F-30-100-50
 AO-connector large	for drilling and milling, cannulated, Ø 4,3mm	•	•	F-30-100-51
 1/4" connector	cannulated, Ø 4,3 mm	•	•	F-30-100-52
 Hudson connector	cannulated, Ø 4,3 mm	•	•	F-30-100-53

|| Subject to modifications. Please note that some products may not be available in all countries. For more detailed information, please consult with your contact partner or directly with Richard Wolf GmbH.

|| Subject to modifications. Please note that some products may not be available in all countries. For more detailed information, please consult with your contact partner or directly with Richard Wolf GmbH.

# bee-system II

Drill & ream and Drill machines standard  
Accessories

Accessories		for Drill & Ream F-31-100-00	for Drill standard F-31-150-00	Product no.
 Harris connector	cannulated, Ø 4,3 mm	•	•	F-30-100-54
 Hexagonal connector SW6	cannulated, Ø 4,3 mm	•	•	F-30-100-55
 DIN coupling for tools		•	•	F-30-100-56
 Drill attachment Jackobs chuck small	with drill chuck key, for drills with sheath diameter 0-4.0mm	•	•	F-30-100-60
 Drill attachment Jackobs chuck large	with drill chuck key, for drills with sheath diameter 0-6.5 mm	•	•	F-30-100-61
 Röhms three jaw chuck	with drill chuck key, for drills with sheath diameter 0-7.0 mm	•	•	F-30-100-62
 Quick action chuck with ratchet	cannulated, Ø 6,0 mm	•	•	F-30-100-63
 Quick action chuck without ratchet	cannulated, max. Ø 6,0 mm	•	•	F-30-100-64
 Albrecht quick action chuck	cannulated, max. Ø 3,5 mm			F-30-100-65

|| Subject to modifications. Please note that some products may not be available in all countries. For more detailed information, please consult with your contact partner or directly with Richard Wolf GmbH.

|| Subject to modifications. Please note that some products may not be available in all countries. For more detailed information, please consult with your contact partner or directly with Richard Wolf GmbH.

## bee-system II

### Oscillating reaming machine

for use in anterior cruciate ligament reconstruction

		Product no.
beesystemII oscillating ream machine		F-31-700-00
Accessories see page 135-Ortho137 / Ortho142		

- Lock position
- Continuously adjustable oscillation speed

Technical data F-31-700-00	
Handpiece dimensions (without attachment)	140 x 111 x 206 mm
Weight of handpiece with powerpack	1550 g
Continuously adjustable rotation speed	0 - 9000 rpm (Step 1)/0 - 11000 rpm (Step 11)
Protection class	B, EN 60601-1
Power supply	Internal battery

VI121 || Subject to modifications. Please note that some products may not be available in all countries. For more detailed information, please consult with your contact partner or directly with Richard Wolf GmbH.

VI121 || Subject to modifications. Please note that some products may not be available in all countries. For more detailed information, please consult with your contact partner or directly with Richard Wolf GmbH.

## bee-system II

### Oscillating reaming machine

Tools for harvesting quadriceps tendon or patellar tendon graft  
with bone block for ACL reconstruction

		Product no.
Hollow burr SZ 8	<ul style="list-style-type: none"> <li>■ Cutting teeth only on 2/3 of the distal burr avoids a too big defect on the patella when harvesting the bone block</li> <li>■ Hollow burs of different diameters allow to harvest anatomically suitable graft diameters for each patient</li> </ul>	8869.841
Hollow burr SZ 9		8869.843
Hollow burr SZ 10		8869.844
		Inner Ø    Outer Ø    WL
		8,4 mm    9,4 mm    90 mm
		9,4 mm    10,4 mm
		10,4 mm    11,4 mm



		Product no.
Suture puller WL 350mm	<ul style="list-style-type: none"> <li>■ Passing the sutures through and pulling the graft into the hollow burr</li> </ul>	8869.921
		Outer Ø    WL
		4 mm    350 mm



		Product no.
Bone elevator SZ 8	<ul style="list-style-type: none"> <li>■ Loosen the bone block from the patella after using a hollow burr</li> </ul>	8868.921
Bone elevator SZ 9		8868.922
Bone elevator SZ 10		8868.923
		Inner Ø    Outer Ø    WL
		8,4 mm    11,1 mm    130 mm
		9,4 mm    11,2 mm
		10,5 mm    12,5 mm

## bee-system II

### Oscillating reaming machine

Tools for reimplanting and press-fit fixation of BT or BTB grafts

		WL	Product no.
	<ul style="list-style-type: none"> <li>● Straight version for use via anteromedial portal</li> <li>● For use via transtibial portal</li> </ul>	110 mm	<b>8869.991</b>
<b>Curved plunger WL 110mm</b>			

		WL	Product no.
	<ul style="list-style-type: none"> <li>● Straight version for use via anteromedial portal</li> <li>● For use via anteromedial portal</li> </ul>	110 mm	<b>8869.993</b>
<b>Pusher straight WL 110mm</b>			

V121 || Subject to modifications. Please note that some products may not be available in all countries. For more detailed information, please consult with your contact partner or directly with Richard Wolf GmbH.



V121 || Subject to modifications. Please note that some products may not be available in all countries. For more detailed information, please consult with your contact partner or directly with Richard Wolf GmbH.



## bee-system II

### Oscillating reaming machine

Tools for hollow drills sets for harvesting cylindrical bone blocks when creating the tibial drill channel

				
		<b>Hollow drill bit</b>		
		<b>Ejector</b>		
Hollow drill bit and ejector	Außen-Ø	Innen-Ø	NL	Product no.
<b>Hollow drill bit SZ 8</b>	8,5 mm	7,4 mm	185	<b>8869849</b>
<b>also: Ejector SZ 8</b>				<b>8869850</b>
<b>Hollow drill bit SZ 9</b>	9,5 mm	8,4 mm	185 mm	<b>8869.851</b>
<b>also: Ejector SZ 9</b>				<b>8869.852</b>
<b>Hollow drill bit SZ 10</b>	10,5 mm	9,4 mm	185 mm	<b>8869.853</b>
<b>also: Ejector SZ 10</b>				<b>8869.854</b>

Base section , aiming spoon and aiming hook		Product no.
	<b>Base section for tibial drill graduated</b>	<b>8874.111</b>
	<b>Aiming hook tibial ACL</b>	<b>8874.121</b>
	<b>Aiming spoon tibial ACL</b>	<b>8874.123</b>

Bohrdrahtführung Hohlbohrer, Bohrerführung Hohlbohrer		Product no.
	<b>Alignment wire guide hollow drill SZ 2.5</b> for use with base section 8874.111	<b>8874.151</b>
	<b>Drill guide for hollow drill bit SZ 8</b> for use with base section 8874.111 and hollow drill bit 8869849 SZ 8	<b>8874150</b>
	<b>Drill guide for hollow drill bit SZ 9</b> for use with base section 8874.111 and hollow drill bit 8869.851 SZ 9	<b>8874.152</b>
	<b>Drill guide for hollow drill bit SZ 10</b> for use with base section 8874.111 and hollow drill bit 8869.853 SZ 10	<b>8874.153</b>

## bee-system II

### Oscillating saws



		Product no.
<b>beesystemII</b> <b>sagital oscillating saw, 4°</b>	(lateral movement) with connection for AO-Synthes saw blades	<b>F-31-300-00</b>
<b>beesystemII</b> <b>sagital oscillating saw</b>	with connection for Stryker sawblades	<b>F-31-310-00</b>
Accessories see page Ortho142		

- With rotatable saw blade clamping in 45° steps (8 positions)
- Manual speed adjustment and oscillating mode
- Shift lever for operating in two different speeds
- With AO-Synthes and Stryker connection of the saw blade

Technical data F-31-300-00 / F-31-310-00	
Handpiece dimensions (without attachment) 166 x 111 x 211 mm	166 x 111 x 211 mm
Weight of handpiece with powerpack 1760 g	1760 g
Continuously adjustable rotation speed 0 - 9000 cpm (Step 1) / 0 - 11000 cpm (Step II)	0-9.000 Zy./min (Stufe I) / 0-11.000 Zy./min (Stufe II)
Protection class B, EN 60601-1	B, EN 60601-1
Power supply Internal battery	Interner Akku

V121 || Subject to modifications. Please note that some products may not be available in all countries. For more detailed information, please consult with your contact partner or directly with Richard Wolf GmbH.

V121 || Subject to modifications. Please note that some products may not be available in all countries. For more detailed information, please consult with your contact partner or directly with Richard Wolf GmbH.

## bee-system II

### Sternum saw



		Product no.
<b>beesystemII</b> <b>sternum saw</b>	with keyless sternum attachment (F-30-400-05)	<b>F-31-601-00</b>
Accessories see page Ortho142		

- Precise cutting guide with good visibility conditions
- Easy clamping of sawblade (no tools required)
- Use of saw blade with Stryker adaption
- Attachment of protection sleeve in 4 different positions possible (locking at 90°)
- Basic model to be used as reprocating

Technical data F-31-601-00	
Handpiece dimensions (without attachment)	185 x 111 x 206 mm
Weight of handpiece with powerpack	1750 g
Continuously adjustable rotation speed	0 - 7500 cpm (Step 1)/0 - 10000 cpm (Step 11)
Protection class	B, EN 60601-1
Power supply	Internal battery

## bee-system II

One powerpack for all machines



		Product no.
<b>Power Pack</b>	Powerpack, universal drive unit for use with all bee-system handpieces, newest Li-Ion technology	<b>F-30-900-00</b>

also: Battery charger see page Ortho141

- 1 powerpack for all handpieces
- Includes control unit, battery, electronics, and motor – united in one powerpack
- Automatic recognition of the performance parameters according to the used handpiece
- Unique durability, no need to sterilize delicate components
- Latest battery technology – long lifetime, no memory effect
- Display for battery charging status: green, orange, red (discharged)
- White LEDs for additional illumination of the OR field

Technical data F-30-900-00	
Dimensions	89 x 87 x 102 mm
Weight	760 g
Type	Li-ion
Max. voltage	16.8 V
Operating voltage (rated voltage)	14.4V
Capacity	2.1 Ah
Typical charging time period	< 90 min

## bee-system II

Battery charger



		Product no.
Battery charger (1 charging slot)		<b>F-30-900-50</b>
Battery charger (2 charging slots)		<b>F-30-900-51</b>
Battery charger (4 charging slots)		<b>F-30-900-52</b>

- All charging units indicate the charging status of the powerpacks.
- In addition to the charging status at the powerpack, the charger displays the charging capacity per powerpack slot.

Technical data F-30-900-50/51/52	
Dimensions	1 charging slot: 157 x 140 x 79 mm 2 charging slots: 240 x 190 x 130 mm 4 charging slots: 520 x 190 x 130 mm
Weight	1 charging slot: 1740 g 2 charging slots: 4939 g 4 charging slots: 8700 g
Type	Li-ion battery charger
Input	100 - 240 V AC 50 - 60 Hz 0,9 A
Output	16,8 V DC 2,0 A







|| Subject to modifications. Please note that some products may not be available in all countries. For more detailed information, please consult with your contact partner or directly with Richard Wolf GmbH.

|| Subject to modifications. Please note that some products may not be available in all countries. For more detailed information, please consult with your contact partner or directly with Richard Wolf GmbH.

# bee-system II

## Accessories



Accessories for bee-system II		Product no.
	<b>Tray with lid, for 1 machine</b> without rinsing set, reusable	<b>F-31-910-13</b>
	<b>Tray with lid, for 2 machines</b> without rinsing set, reusable	<b>F-31-910-18</b>
	<b>Rinsing set</b> reusable	<b>F-30-910-40</b>
	<b>Cleaning brush set</b> reusable	<b>F-30-910-50</b>
	<b>Hi-tech oil pen</b>	<b>F-30-900-61</b>
	<b>Sterile funnel</b> for insertion of powerpack F-30-900-00 under sterile conditions, reusable	<b>F-30-900-20</b>
	<b>Lubrication service frame</b> reusable	<b>F-30-900-10</b>
	<b>Poag cable for charging units</b> for connecting F-30-900-50 or F-30-900-51 or F-30-900-52 to potential equalization	<b>F-30-900-57</b>

|| Subject to modifications. Please note that some products may not be available in all countries. For more detailed information, please consult with your contact partner or directly with Richard Wolf GmbH.



