

Keep the
balance in sight

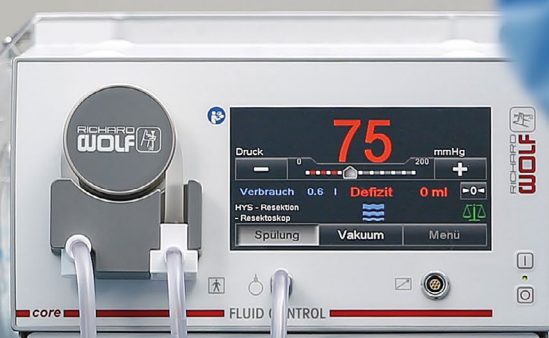

FLUID CONTROL 2225

Suction and irrigation pump
for gynecology, urology and general surgery

FLUID CONTROL 2225

One pump. Three disciplines. No license fee.

The new **FLUID CONTROL 2225** suction and irrigation pump from Richard Wolf always offers you excellent sight and monitoring.

Independently of the area of application, whether in gynecology, urology or general surgery, you have a license for flexibility. One click guides you to the relevant intervention – without any expensive fees.

Flexibility

- **One pump. Three disciplines.**
Interdisciplinary application in gynecology, urology and general surgery
- **No license fee**
Interdisciplinary application without any additional costs
- **Individual instrument presets**
for maximum irrigation performance
- **Mobile balancing module**
Easy switching between operating theaters
- **Compatible with endoscopes from other manufacturers**
when standard mode is selected
- **One tube set for all applications**
as a disposable or reusable solution
- **Integrated core nova interface**
Control via core nova operating integration system possible



Performance

- 1800 ml/min irrigation performance*
- 2000 ml/min suction performance*
- Continuous irrigation flow
Even in small sized instruments
- **NEW: Integrated vacuum function**
Fast exchange of fluid for optimum visualization conditions
- **60% higher irrigation performance**
compared to previous models

Safety

- Outstanding visualization in any surgical circumstances
as a result of permanent irrigation flow and vacuum function
- Large, clear touchscreen color display
- Continuous monitoring and display of fluid deficit
throughout the entire intervention
- Two integrated weighing cells
for precise balancing
- System monitoring
Warning messages and signals if there are any deviations



@Gynecology

page 4

@Urology

page 6

@General Surgery

page 9

FLUID CONTROL 2225 and Accessories

page 10

* depending on the specialism and intervention

FLUID CONTROL 2225

The suction and irrigation pump.
@Gynecology

GYNECOLOGY

Diagnosis



- **Simple instrument selection**
using touch display
- **"Plug-and-Play"**
by using instrument presets

- **Pressure-controlled indication**
Optimally adjusted pressure value
- **Optimum irrigation performance**
also with small sized instruments
- **Endoscopes from other manufacturers**
can be used with standard adjustment
- **Perioperative permanent maximum power**



Insight through efficiency

Presets specially tailored to the Richard Wolf Instrument Set ensure highly efficient and continuous irrigation performance, even with small sized instruments.

When using endoscopes from other manufacturers, the standard setting should be used.

Resection

GYNECOLOGY

- **Control and safety**
to avoid a TUR Syndrome
during resection

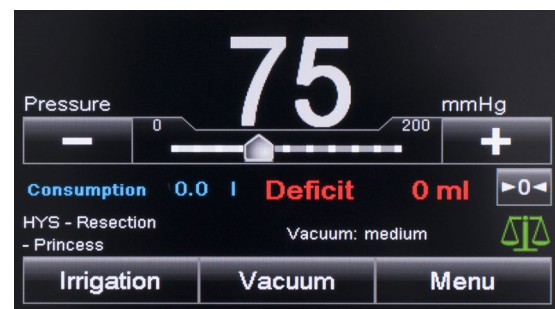

- **Pressure-controlled indication**
Optimally adjusted pressure setting
- **Permanent display and monitoring**
of the fluid deficit
- **Acoustic warning signal**
if the permitted quantity is exceeded

Balancing made easy

Two integrated weighing cells are located in the balancing module. They enable the fluid deficit to be determined conveniently and precisely.



FLUID CONTROL 2225

The suction and irrigation pump.
@Urology

UROLOGY

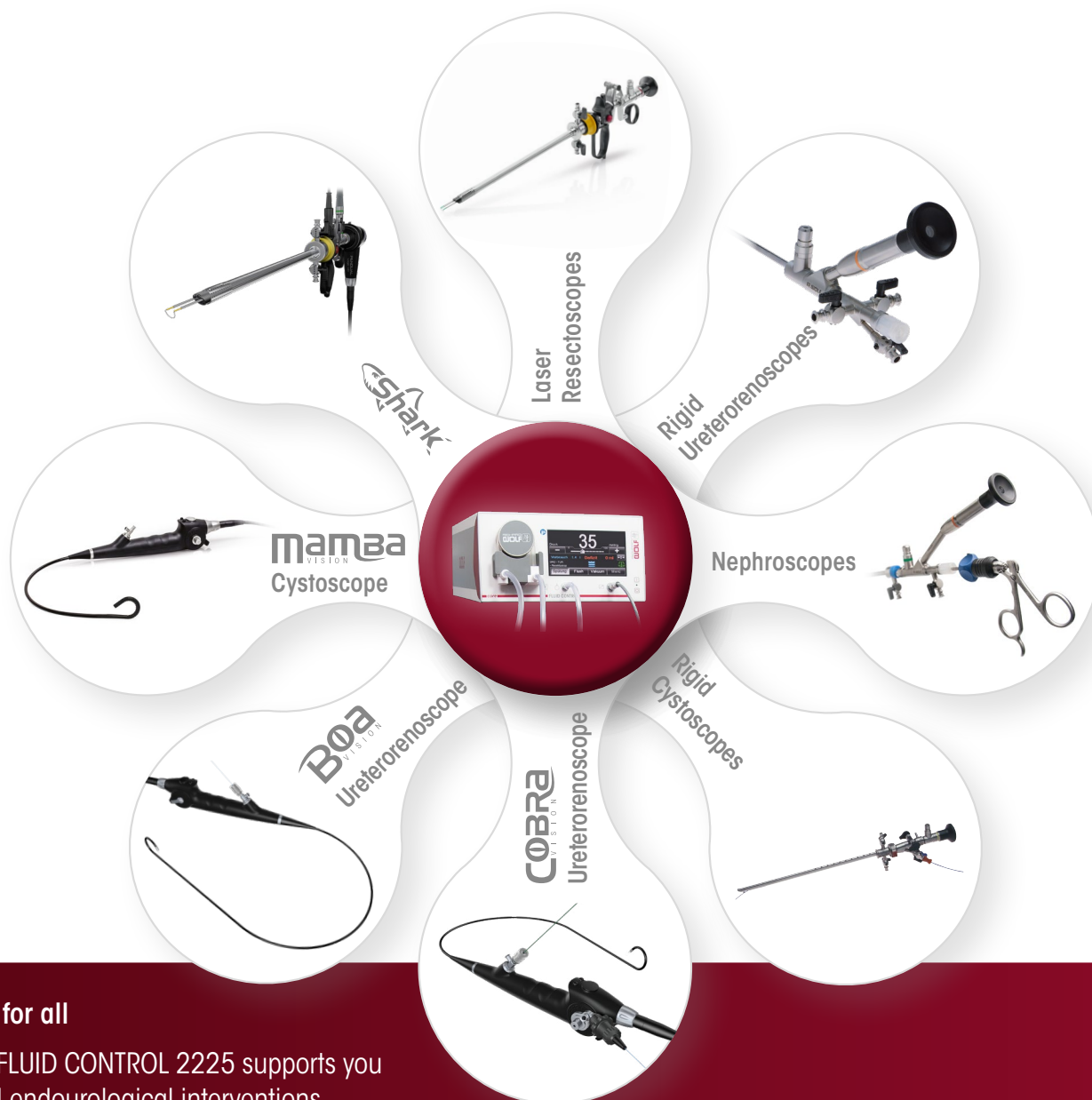

One for all

The FLUID CONTROL 2225 supports you
in all endourological interventions.

Cystoscopy & Resection

- **Rigid and flexible cystoscopy**
- **Pressure-controlled indication**
Optimized to the bladder by adjusting the pressure setting

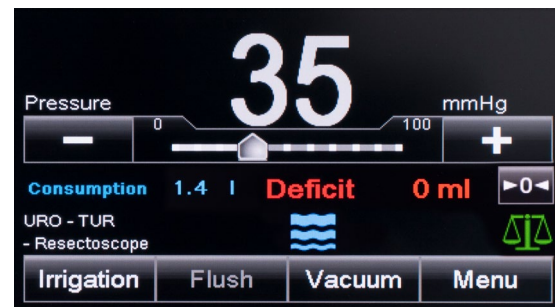

- **Pressure-controlled indication**
Optimized for use in TUR
- **Best visibility**
as a result of "Flush" function
- **Precise display of the deficit**
Control of the volume of irrigation fluid in patients
- **Avoidance of TUR syndrome**
Constant monitoring of the fluid deficit

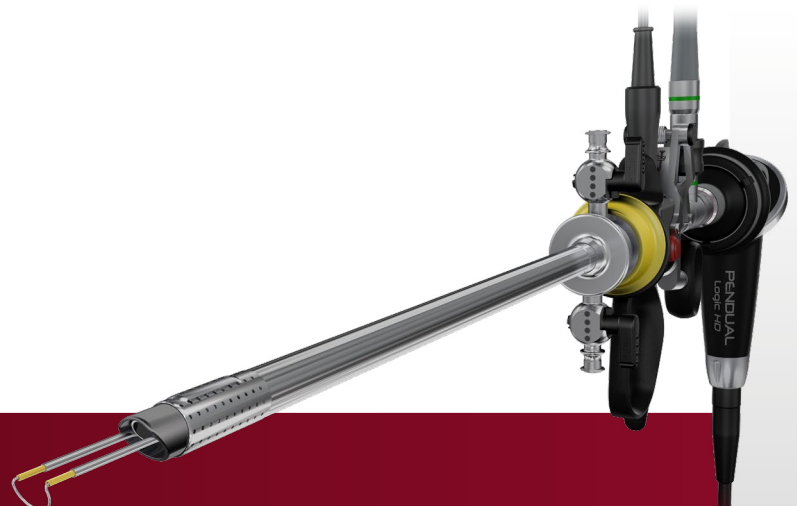

Pressure-controlled indications

The FLUID CONTROL 2225 works with pressure settings optimally adjusted to the individual organs. The balancing module permits precise monitoring of the fluid deficit.

FLUID CONTROL 2225

The suction and irrigation pump.
@Urology

PCNL & URS

UROLOGY

Mini PCNL or standard PCNL

- **Pressure and flow-controlled indication**
Simultaneous control of nominal pressure and nominal flow
- **NEW: Integrated vacuum function**
Fast fluid exchange for optimum visibility

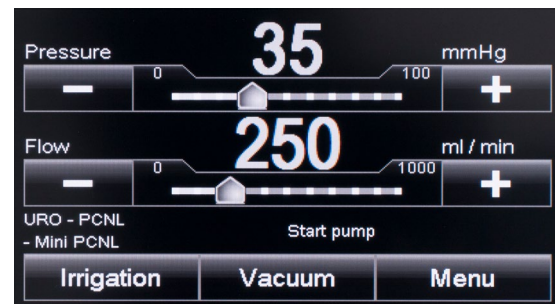

Semirigid or flexible URS

- **Flow-controlled indication**
For a consistently strong irrigation flow
- **Fast exchange to cystoscopy is possible during URS by "Cysto" function**
No menu selection necessary

Flexible URS without pulsation

- **Consistently strong irrigation flow**
for maximum irrigation performance
- **Specially for small sized flexible instruments**

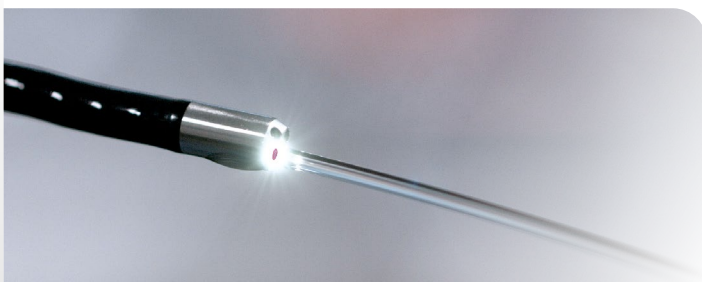

Ureterorenoscopy (URS) – flow-controlled indication

The optimized pump wheel permits continuous, uniform irrigation flow – specially in the case of small sized instruments.



FLUID CONTROL 2225

The suction and irrigation pump.
@General Surgery

GENERAL SURGERY

Laparoscopy

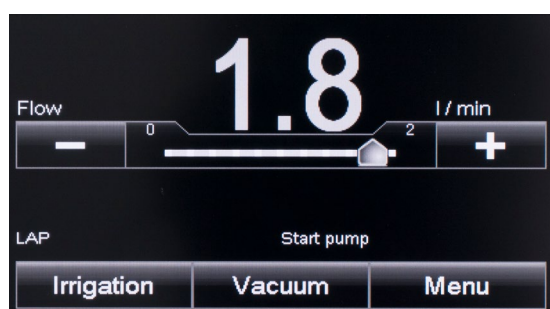

- Factory fixed preset pressure
- Flexibly selectable nominal flow
- 1800 ml/min irrigation performance for outstanding visualization conditions in any surgical situation
- 2000 ml/min suction performance



Cleverly combined

An ideal combination: the FLUID CONTROL 2225 together with our proven suction-irrigation instrument system.

Irrigation and suction are carried out easily and conveniently by touching a button that ensures an excellent overview of the surgical field.

FLUID CONTROL 2225

Ordering Information

FLUID CONTROL 2225

Irrigation pump for HYS / URO / LAP

Fluid management for irrigation of irrigation fluids into the uterus and the upper and lower urinary tract and for the suction-irrigation function in the abdomen

FLUID CONTROL 2225 **2225001**

FLUID CONTROL 2225, incl. power cable **22250011**

Technical data

Voltage range (V)	100 - 240 V~	
Supply frequency (Hz)	50/60 Hz	
Power consumption	Current (A)	Power consumption (VA)
100 V / 60 Hz	1.10 A	110 VA
240 V / 50 Hz	0.50 A	118 VA
Protection class (I, II)	I	
Operating conditions	+10 to +40 °C 30 to 75 % rel. atmospheric humidity 70 to 106 kPa air pressure 3000 m max. operating altitude above sea level	
Storage, transport and shipping conditions	-20 to +60 °C 10 to 90 % rel. atmospheric humidity 70 to 106 kPa air pressure	
Maximum suction negative pressure	-60 kPa	
Adjustable values / ranges		
Nominal flow range	Hysteroscopy: 800 ml/min (max. flow, not adjustable)	
	Endourology: 10 - 800 ml/min (max. flow)	
	Laparoscopy: 0.1- 1.8 l/ min (max. flow)	
Suction power	max. 2 l/min	
Output nominal pressure range	Hysteroscopy: 15 - 200 mmHg	
	Endourology: 15 - 90 mmHg / 20 - 125 cmH2O	
	Laparoscopy: 370 mmHg (fixed setting)	
Pressure	0 - 300 mmHg	
Deficit / Consumption	-9990 to +9990 ml / 0 to 99.9 l	
Dimensions (W x H x D)	300 mm x 157 mm x 436 mm	
Weight	8.8 kg	

Balancing module

for hysteroscopy and endourology, fluid management for fluid balancing in combination with FLUID CONTROL 2225, mobile stands with integrated load cells and accommodation

for up to 4 irrigation fluid bags **2225023**

Technical data

Operating conditions	+10 to +40 °C 30 to 75 % rel. atmospheric humidity 70 to 106 kPa air pressure 3000 m max. operating altitude above sea level
Storage, transport and shipping conditions	-20 to +60 °C 10 to 90 % rel. atmospheric humidity 70 to 106 kPa air pressure
Maximum load for the vessel scales	16 kg / 4 containers with 3 l each
Maximum load for bag scales	23 kg / 4 bags with 5 l each
Dimensions (W x H x D)	618 mm x 1064 mm x 618 mm

Footswitch

only usable in urology and within the indication TUR / enucleation, possibility of short-term increase of pressure if visualization conditions are poor

("Flush" function) **2204901**

Technical data

Voltage range	max. 24 V
Power consumption	Electricity (A): max. 0.1 A
Plug	7-pole circular connector
Cable length	4.5 m
Dimensions (W x H x D)	66 mm x 27 mm x 91 mm
Weight	300 g

Irrigation tubes

Irrigation tube Set

with piercing connector, 3 m,
with Y-piece, with luer-lock connector, pack of 10,
sterile, for single use **4171223**

Irrigation tube set

with care-lock, 3 m, pack of 10,
sterile, for single use **4171224**

Suction-irrigation tube set

3 m, pack of 10,
sterile, for single use **4171225***

Irrigation tube set

with piercing connector, with luer-lock connector,
incl. 10 replacement membranes, reusable
20x autoclavable **8171223***

Tube set for suction

with 2 ports, 5 m, pack of 10,
sterile, for single use **T0503-01**

Vacuum tube with filter

1.7 m, pack of 10,
usable for 30 days **2206207**

Cabling accessories

Patch cable

Cable length: 0.5 m **72325378**
Cable length: 1.0 m **72325429**
Cable length: 10 m **72325434**

Tube attachment

with luer-lock connector,
for suction-irrigation handle 8385.901
and tube set 8171223 or 8170.223,
reusable **817123***

Suction tube

3 m, for suction-irrigation handle 8385.901,
reusable **8171402***

Secretion container

Secretion container 2,5 l complete, for single use

Comprising:
Secretion container 2,5 l (4170.6566) and Secretion bag,
pack of 90 (4170.6564) **4170.657**

Angular plug-in coupling 90°,

pack of 10 **077.1019**

Secretion container 2 Liter,

reusable..... **8170.6551**
lid **8170.6552**

Plastic cap for network socket

Pack of 8 **5592105**

Power cable

Cable length: 2.0 m **2440.03**

* not for U.S. device

