

**UROLOGY**

## UROLOGY

1

LOWER URINARY TRACT

2

UPPER URINARY TRACT

3

PEDIATRIC UROLOGY

4

AUXILIARY INSTRUMENTS

5

LAPAROSCOPY



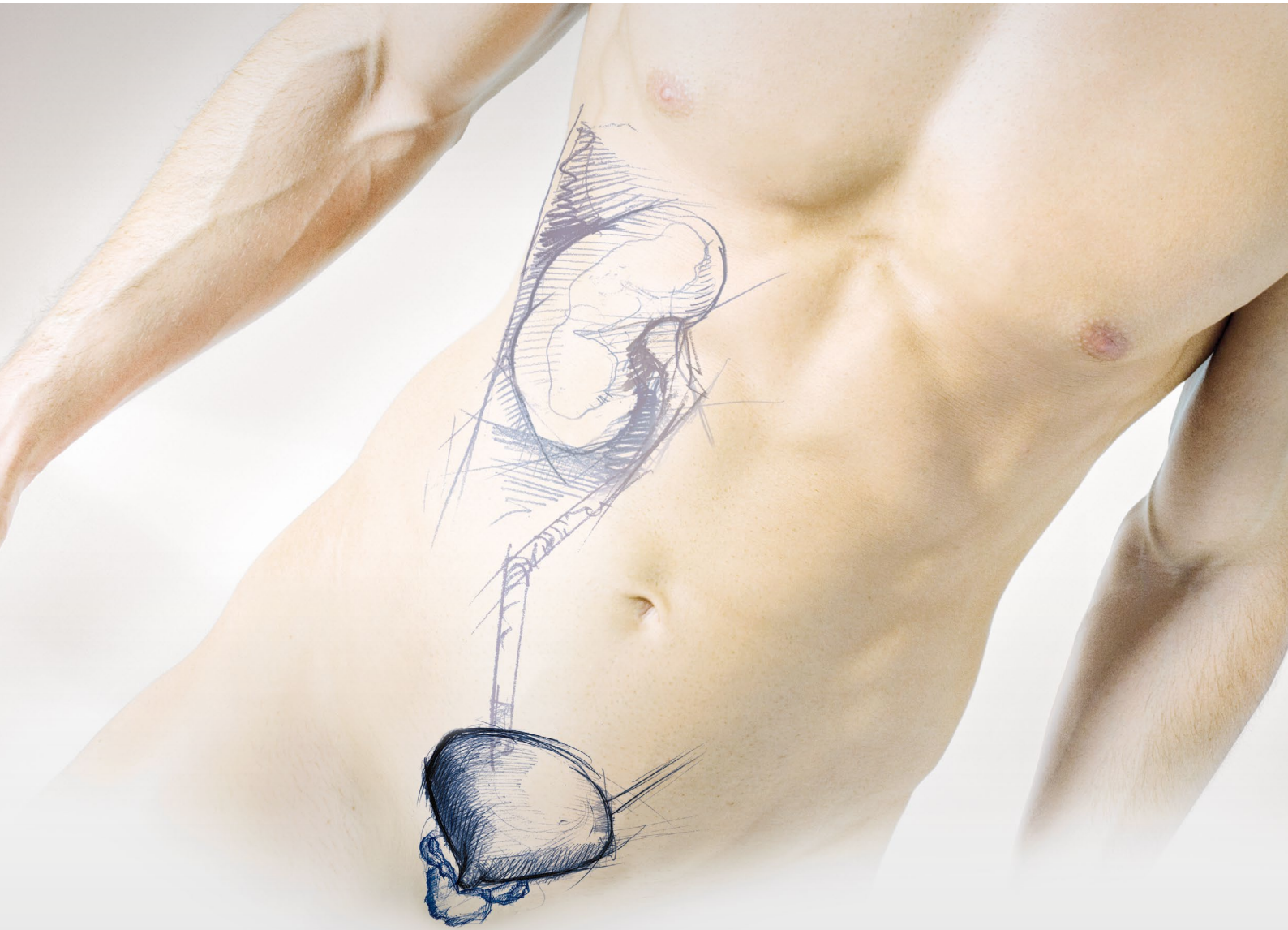

## LOWER URINARY TRACT

## LOWER URINARY TRACT

1.1

### BASIC SETS/OVERVIEW OF PANOVVIEW TELESCOPES

#### URETHROTOMY

1.2

### OPTICAL URETHROTOMES

1.3

### URETHROTOME FOR BLIND SLITTING

#### CYSTOSCOPY

1.4

### CYSTO-URETHROSCOPE 8650

1.5

### "MIDI-SIZE" CYSTO-URETHROSCOPE

1.6

### ATRAUMATIC COMPACT CYSTO-URETHROSCOPE

1.7

### FLEXIBLE FIBER CYSTOSCOPE

1.8

### "VISION EF" FLEXIBLE SENSOR CYSTOSCOPES

1.9

### "MAMBA" FLEXIBLE SENSOR CYSTOSCOPES

1.10

### "SYSTEM BLUE" FOR PHOTODYNAMIC DIAGNOSTICS (PDD)

#### TRANSURETHRAL RESECTION (TUR)

1.11

### "SHARK" RESECTOSCOPES (MONOPOLAR/BIPOLAR)

1.12

### "E-LINE" RESECTOSCOPE, LONG SHEATH

1.13

### "MIDI-SIZE" RESECTOSCOPE

1.14

### "SYSTEM BLUE" FOR PHOTODYNAMIC DIAGNOSTICS (PDD)

1.15

### "SHARK" ELECTRODES (MONOPOLAR/BIPOLAR) – "E-LINE" ELECTRODES

1.16

### ACCESSORIES FOR RESECTOSCOPE SHEATHS



## LOWER URINARY TRACT

<b>ANATOMIC ENDOSCOPIC ENUCLEATION OF THE PROSTATE (AEEP)</b>	
<b>LASER ENUCLEATION (HoLEP/ThuLEP/GreenLEP)</b>	<b>1.17</b>
<b>BIPOLAR ENUCLEATION (BipoLEP)</b>	<b>1.18</b>
<b>MORCELLATION</b>	
<b>"SHARK" MORCESCOPE</b>	<b>1.19</b>
<b>"PIRANHA" MORCELLATION SYSTEM</b>	<b>1.20</b>
<b>LASER ENERGY SOURCES</b>	
<b>"MEGA PULSE 70+" HOLMIUM:YAG LASER (Ho:YAG)</b>	<b>1.21</b>
<b>"PULVIS 60+" THULIUM FIBER LASER (TFL)</b>	<b>1.22</b>
<b>HF ENERGY SOURCES</b>	
<b>HF GENERATOR 2260</b>	<b>1.23</b>
<b>HF CONNECTION CABLE</b>	<b>1.24</b>
<b>SUCTION IRRIGATION PUMP</b>	
<b>FLUID CONTROL 2225</b>	<b>1.25</b>

# BASIC EQUIPMENT FOR CYSTOSCOPY

## *E-line* CYSTO-URETHROSCOPES 8650

Product	Product no.	Quantity	Catalog/Section
<b>Endoscopes and instruments</b>			
Sheath for cystoscope 19.5 FR	8650.0341	1	Urology/Cystoscopes
Adapter for cystoscope	8650.264	1	
Working insert for cystoscope 0/30/70	8650.204	1	
Universal sealing valve 1–6 FR	4712348	1	
Viewing obturator for cystoscope 19.5 FR	8650.724	1	
Opt. biopsy forceps, "Marburg" model	8650.614	1	
Opt. grasping forceps, straight	8650.684	1	
Telescope 0° Ø 4 mm WL 298 mm	8650.414	1	
Telescope 70° Ø 4 mm WL 302 mm	8650.415	1	
Urethrotome 15–45 FR WL 236 mm	8517.00	1	
Bladder syringe 150 ml Ø 54 mm	822.31	1	
Flexible adapter for bladder syringe	822.13	1	
Perforated basket for standard telescope 2	38016	1	Hygiene
Container (W x H x D) 400 x 60 x 200 mm	33022	1	



## BASIC EQUIPMENT FOR TUR

**Shark** RESECTOSCOPE, MONOPOLAR  
 TELESCOPE 4 MM, 12°/30°  
 24/26 FR, ACTIVE, CONTINUOUS IRRIGATION

Product	Product no.	Quantity	Catalog/Section
<b>Endoscopes and instruments</b>			
Outer sheath for resectoscope 26 FR	8675426	1	Urology/Resectoscopes
Inner sheath for resectoscope 24 FR	8675324	1	
Dilations obturator f. resectoscope 24 FR	8673224	1	
Obturator for resectoscope 24 FR	8673024	1	
Viewing obturator for resectoscope 24 FR	8673124	1	
Working element, active, bipo 0/12/30°	8680.205	1	
Telescope 12° Ø 4 mm WL 297 mm	8654.431	1	
Telescope blue 12° Ø 4 mm WL 298 mm	8654.531	1	
Telescope 30° Ø 4 mm WL 300 mm	8654.422	1	
Telescope blue 30° Ø 4 mm WL 299 mm	8654.522	1	
Cutting electrode mono 24 FR 12/30°	46782435	1	
Coag. electrode mono 22–24 FR 12/30°	46782201	1	
Protective sterilization sleeve	33030	1	
HF monopolar connection cable	see URO103/104	1	
Urethrotome 15–45 FR WL 236 mm	8517.00	1	Urology/Urethrotomes
Knife for urethrotome	8517.90	1	
Irrigation pump for HYS/URO/LAP bndI	22250011	1	Urology/Resectoscopes
Bladder syringe 150 ml Ø 54 mm	822.31	1	Urology/Auxiliary instruments
Flexible adapter for bladder syringe	822.13	1	

## BASIC EQUIPMENT FOR TUR

**Shark** RESECTOSCOPE, MONOPOLAR  
TELESCOPE 4 MM, 0°  
24 FR, PASSIVE, INTERMITTENT IRRIGATION WITH CENTRAL STOPCOCK

Product	Product no.	Quantity	Catalog/Section
<b>Endoscopes and instruments</b>			
Sheath for resectoscope 24 FR	8676424	1	Urology/Resectoscopes
Connection part for resectoscope 24 FR	8676342	1	
Dilatations obturator f. resectoscope 24 FR	8673224	1	
Viewing obturator for resectoscope 24 FR	8673124	1	
Obturator for resectoscope 24 FR	8673024	1	
Working element, passive, mono 0°	8681224	1	
Telescope 0° Ø 4 mm WL 298 mm	8650.414	1	
Telescope blue 0° Ø 4 mm WL 298 mm	8650.514	1	
Cutting electrode mono 24 FR 0°	46792435	1	
Protective sterilization sleeve	33030	1	
HF monopolar connection cable	see UR0103/104	1	
Urethrotome 15–45 FR WL 236 mm	8517.00	1	Urology/Urethrotomes
Knife for urethrotome	8517.90	1	
Bladder syringe 150 ml Ø 54 mm	822.31	1	Urology/Auxiliary instruments
Flexible adapter for bladder syringe	822.13	1	



## BASIC EQUIPMENT FOR TUR

 RESECTOSCOPE, MONOPOLAR

TELESCOPE 4 MM, 0°

24 FR, PASSIVE, INTERMITTENT IRRIGATION WITH ROTATABLE IRRIGATION ADAPTER

Product	Product no.	Quantity	Catalog/Section
<b>Endoscopes and instruments</b>			
Sheath for resectoscope 24 FR	8676324	1	Urology/Resectoscopes
Irrigation adapter for resectoscope 24/26 FR with 4 mm Luer connection	8676354	1	
Irrigation adapter for resectoscope 24/26 FR with 3 mm Luer connection with stopcock	8676361	1	
Two-way stopcock, maintenance-free	88351	1	
Dilatations obturator f. resectoscope 24 FR	8673224	1	
Viewing obturator for resectoscope 24 FR	8673124	1	
Obturator for resectoscope 24 FR	8673024	1	
Working element, passive, mono 0°	8681224	1	
Telescope 0° Ø 4 mm WL 298 mm	8650.414	1	
Telescope blue 0° Ø 4 mm WL 298 mm	8650.514	1	
Cutting electrode mono 24 FR 0°	46792435	1	
Protective sterilization sleeve	33030	1	
HF monopolar connection cable	see URO103/104	1	
Urethrotome 15–45 FR WL 236 mm	8517.00	1	Urology/Urethrotomes
Knife for urethrotome	8517.90	1	
Bladder syringe 150 ml Ø 54 mm	822.31	1	Urology/Auxiliary instruments
Flexible adapter for bladder syringe	822.13	1	

## BASIC EQUIPMENT FOR TUR

**Shark** RESECTOSCOPE, BIPOLAR  
TELESCOPE 4 MM, 12°/30°  
22/24 FR, ACTIVE, CONTINUOUS IRRIGATION

Product	Product no.	Quantity	Catalog/Section
<b>Endoscopes and instruments</b>			
Outer sheath for resectoscope 24 FR	8675424	1	Urology/Resectoscopes
Inner sheath for resectoscope 22 FR	8675322	1	
Viewing obturator for resectoscope 22 FR	8673122	1	
Obturator for resectoscope 22 FR	8673022	1	
Working element, active, bipo 0/12/30°	8680.205	1	
Telescope 12° Ø 4 mm WL 297 mm	8654.431	1	
Telescope blue 12° Ø 4 mm WL 298 mm	8654.531	1	
Telescope 30° Ø 4 mm WL 300 mm	8654.422	1	
Telescope blue 30° Ø 4 mm WL 299 mm	8654.522	1	
Cutting electrode bipo 22 FR 12/30°	4622.1333	1	
Coag. electrode bipo 22 FR 12/30°	4623.0243	1	
BiVAP-Elektrode bipo 22 FR 12/30°	46300223	1	
HF bipolar connection cable	see URO105	1	
Urethrotome 15–45 FR WL 236 mm	8517.00	1	Urology/Urethrotomes
Knife for urethrotome	8517.90	1	
Irrigation pump for HYS/URO/LAP bndI	22250011	1	Urology/Resectoscopes
Bladder syringe 150 ml Ø 54 mm	822.31	1	Urology/Auxiliary instruments
Flexible adapter for bladder syringe	822.13	1	



## BASIC EQUIPMENT FOR TUR

**Shark** RESECTOSCOPE, BIPOLAR  
 TELESCOPE 4 MM, 12°/30°  
 24/26 FR, ACTIVE, CONTINUOUS IRRIGATION

Product	Product no.	Quantity	Catalog/Section
<b>Endoscopes and instruments</b>			
Outer sheath for resectoscope 26 FR	8675426	1	Urology/Resectoscopes
Inner sheath for resectoscope 24 FR	8675324	1	
Dilatations obturator f. resectoscope 24 FR	8673224	1	
Obturator for resectoscope 24 FR	8673024	1	
Viewing obturator for resectoscope 24 FR	8673124	1	
Working element, active, bipo 0/12/30°	8680.205	1	
Telescope 12° Ø 4 mm WL 297 mm	8654.431	1	
Telescope blue 12° Ø 4 mm WL 298 mm	8654.531	1	
Telescope 30° Ø 4 mm WL 300 mm	8654.422	1	
Telescope blue 30° Ø 4 mm WL 299 mm	8654.522	1	
Coag. electrode bipo 22 FR 12/30°	4623.0243	1	
BiVAP-Elektrode bipo 22 FR 12/30°	46300223	1	
BiVAP-Elektrode bipo 24–26 FR 12/30°	46300243	1	
HF bipolar connection cable	see URO105	1	
Urethrotome 15–45 FR WL 236 mm	8517.00	1	Urology/Urethrotomes
Knife for urethrotome	8517.90	1	
Irrigation pump for HYS/URO/LAP bndl	22250011	1	Urology/Resectoscopes
Bladder syringe 150 ml Ø 54 mm	822.31	1	Urology/Auxiliary instruments
Flexible adapter for bladder syringe	822.13	1	

## BASIC EQUIPMENT FOR TUR

**Shark** RESECTOSCOPE, BIPOLAR

TELESCOPE 4 MM, 12°

24 FR, ACTIVE, INTERMITTENT IRRIGATION WITH CENTRAL STOPCOCK

Product	Product no.	Quantity	Catalog/Section
<b>Endoscopes and instruments</b>			
Outer sheath for resectoscope 26 FR	8675426	1	Urology/Resectoscopes
Inner sheath for resectoscope 24 FR	8675324	1	
Dilatations obturator f. resectoscope 24 FR	8673224	1	
Obturator for resectoscope 24 FR	8673024	1	
Viewing obturator for resectoscope 24 FR	8673124	1	
Working element, active, bipo 0/12/30°	8680.205	1	
Telescope 12° Ø 4 mm WL 297 mm	8654.431	1	
Telescope blue 12° Ø 4 mm WL 298 mm	8654.531	1	
Coag. electrode bipo 22 FR 12/30°	4623.0243	1	
BiVAP-Elektrode bipo 22 FR 12/30°	46300223	1	
BiVAP-Elektrode bipo 24–26 FR 12/30°	46300243	1	
HF bipolar connection cable	see URO105	1	
Urethrotome 15–45 FR WL 236 mm	8517.00	1	Urology/Urethrotomes
Knife for urethrotome	8517.90	1	
Irrigation pump for HYS/URO/LAP bndI	22250011	1	Urology/Resectoscopes
Bladder syringe 150 ml Ø 54 mm	822.31	1	Urology/Auxiliary instruments
Flexible adapter for bladder syringe	822.13	1	



HoLEP, ThuLEP  
**BASIC LASER ENUCLEATION SET I**  
 STANDARD LASER RESECTOSCOPE 24/26 FR

Product	Product no.	Quantity	Catalog/Section
<b>"PIRANHA" morcellator</b>			
Suction pump bndl	22080019	1	Urology/Laser enucleation
Tube for suction	41702208	1	
Collecting container	2208120	1	
Motor Control Unit 2303	2303.001	1	
Also: Power cable	2440.03	1	
Motor handpiece max. 6,000 rpm	8564122	1	
Rotary morcellator Ø 4.8 mm WL 335 mm	49700113	1	
Rotary morcellator Ø 4.8 mm WL 385 mm for morcellator telescopes <i>from other manufacturers</i>	49700103	1	
<b>Laser resectoscope 24/26 Fr</b>			
Telescope 30° Ø 4 mm WL 300 mm	8654.422	1	Urology/Laser enucleation
Telescope 12° Ø 4 mm WL 297 mm	8654.431	1	
Also: Fiber light cable bndl, Ø 2.5 mm, 2.3 m long	806625231	1	
for reprocessing: Perforated basket for standard telescope 2	38016	1	
Laser working element, passive 12/30°	8654382	1	
Alternative: Laser working insert 12/30°	8654383	1	
Guide tube laser therapy 1,000 µm 24 FR	8654991	1	
Guide tube laser therapy 600 µm 24 FR	8654993	1	
Guide tube laser therapy 600 µm 24 FR	8654995	1	
Guide tube laser therapy 600 µm 24 FR	8654997	1	
Curette 22–24 FR for prostate chips	8654998	1	

IX23|| Subject to modifications. Please note that some products may not be available in all countries. Please always take note of the information that is provided with the product. For more detailed information, please consult with your contact partner or directly with Richard Wolf GmbH.



HoLEP, ThuLEP

## BASIC LASER ENUCLEATION SET I

STANDARD LASER RESECTOSCOPE 24/26 FR

Product	Product no.	Quantity	Catalog/Section
<b>Laser resectoscope 24/26 Fr</b>			
Outer sheath for resectoscope 26 FR	8675426	1	Urology/Laser enucleation
Inner sheath for resectoscope 24 FR	8675324	1	
Obturator for resectoscope 24 FR	8673024	1	
Viewing obturator for resectoscope 24 FR	8673124	1	
Dilatations obturator f. resectoscope 24 FR	8673224	1	
<b>MORCESCOPE</b>			
Morcescope 0° 24 FR WL 199 mm	8970407	1	Urology/Laser enucleation
Autom. sealing element ID 5.7 mm	8920.311	1	
Pressure ball	103.00	1	
Tube with LUER-LOCK connector	886.00	1	
Cleaning brush Ø 11 mm TL 360 mm	6.01	1	
Also:			
Fiber light cable bndl Ø 3.5 mm, 2.3 m long	806635231	1	
Perforated basket for Morcescope with small part basket	38012	1	

IX23 || Subject to modifications. Please note that some products may not be available in all countries. Please always take note of the information that is provided with the product. For more detailed information, please consult with your contact partner or directly with Richard Wolf GmbH.





HOLEP, THULEP

## BASIC LASER ENUCLEATION SET II

LASER ENUCLEATION SHEATH FOR **BLUNT** ENUCLEATION 24/26 FR

Product	Product no.	Quantity	Catalog/Section
<b>"PIRANHA" morcellator</b>			
Suction pump bndl	22080019	1	Urology/Laser enucleation
Tube for suction	41702208	1	
Collecting container	2208120	1	
Motor Control Unit 2303	2303.001	1	
Also: Power cable	2440.03	1	
Motor handpiece max. 6,000 rpm	8564122	1	
Rotary morcellator Ø 4.8 mm WL 335 mm	49700113	1	
Rotary morcellator Ø 4.8 mm WL 385 mm for morcellator telescopes <i>from other manufacturers</i>	49700103	1	
<b>Laser resectoscope 24/26 Fr</b>			
Telescope 30° Ø 4 mm WL 300 mm	8654.422	1	Urology/Laser enucleation
Telescope 12° Ø 4 mm WL 297 mm	8654.431	1	
Also: Fiber light cable bndl, Ø 2.5 mm, 2.3 m long	806625231	1	
for reprocessing: Perforated basket for standard telescope 2	38016	1	
Laser working element, passive 12/30°	8654382	1	
Alternative: Laser working insert 12/30°	8654383	1	
Guide tube laser therapy 1,000 µm 24 FR	8654991	1	
Guide tube laser therapy 600 µm 24 FR	8654993	1	
Guide tube laser therapy 600 µm 24 FR	8654995	1	
Guide tube laser therapy 600 µm 24 FR	8654997	1	
Curette 22–24 FR for prostate chips	8654998	1	

IX23|| Subject to modifications. Please note that some products may not be available in all countries. Please always take note of the information that is provided with the product. For more detailed information, please consult with your contact partner or directly with Richard Wolf GmbH.



HOLEP, THULEP  
**BASIC LASER ENUCLEATION SET II**  
 LASER ENUCLEATION SHEATH FOR **BLUNT** ENUCLEATION

Product	Product no.	Quantity	Catalog/Section
<b>Laser enucleation sheath for blunt enucleation 24/26 Fr</b>			
Outer sheath for resectoscope 26 FR	8675426	1	Urology/Laser enucleation
Inner sheath for laser therapy 24 FR	8675524	1	
Obturator for resectoscope 24 FR	8673324	1	
Alternative:			
Outer sheath for resectoscope 26 FR	8675426	1	
Inner sheath for resectoscope 24 FR	8675324	1	
Obturator for resectoscope 24 FR	8673024	1	
Dilatations obturator f. resectoscope 24 FR	8673224	1	
<b>MORCESCOPE</b>			
Morcescope 0° 24 FR WL 199 mm	8970407	1	Urology/Laser enucleation
Autom. sealing element ID 5.7 mm	8920.311	1	
Pressure ball	103.00	1	
Tube with LUER-LOCK connector	886.00	1	
Cleaning brush Ø 11 mm TL 360 mm	6.01	1	
Also:			
Fiber light cable bndl Ø 3.5 mm, 2.3 m long	806635231	1	
Perforated basket for Morcescope with small part basket	38012	1	

IX23 || Subject to modifications. Please note that some products may not be available in all countries. Please always take note of the information that is provided with the product. For more detailed information, please consult with your contact partner or directly with Richard Wolf GmbH.



HOLEP, THULEP

BASIC LASER ENUCLEATION SET III

STANDARD LASER RESECTOSCOPE 24/26 FR AND BIPOLAR RESECTION

Product	Product no.	Quantity	Catalog/Section
<b>"PIRANHA" morcellator</b>			
Suction pump bndl	22080019	1	Urology/Laser enucleation
Tube for suction	41702208	1	
Collecting container	2208120	1	
Motor Control Unit 2303	2303.001	1	
Also: Power cable	2440.03	1	
Motor handpiece max. 6,000 rpm	8564122	1	
Rotary morcellator Ø 4.8 mm WL 335 mm	49700113	1	
Rotary morcellator Ø 4.8 mm WL 385 mm for morcellator telescopes <i>from other manufacturers</i>	49700103	1	
<b>Laser resectoscope 24/26 Fr</b>			
Telescope 30° Ø 4 mm WL 300 mm	8654.422	1	Urology/Laser enucleation
Telescope 12° Ø 4 mm WL 297 mm	8654.431	1	
Also: Fiber light cable bndl, Ø 2.5 mm, 2.3 m long	806625231	1	
for reprocessing: Perforated basket for standard telescope 2	38016	1	
Laser working element, passive 12/30°	8654382	1	
Alternative: Laser working insert 12/30°	8654383	1	
Guide tube laser therapy 1,000 µm 24 FR	8654991	1	
Guide tube laser therapy 600 µm 24 FR	8654993	1	
Guide tube laser therapy 600 µm 24 FR	8654995	1	
Guide tube laser therapy 600 µm 24 FR	8654997	1	
Curette 22–24 FR for prostate chips	8654998	1	

IX23|| Subject to modifications. Please note that some products may not be available in all countries. Please always take note of the information that is provided with the product. For more detailed information, please consult with your contact partner or directly with Richard Wolf GmbH.



HOLEP, THULEP

**BASIC LASER ENUCLEATION SET III**

STANDARD LASER RESECTOSCOPE 24/26 FR AND BIPOLAR RESECTION



spirit of excellence

BASIC SETS

1.1

Product	Product no.	Quantity	Catalog/Section
<b>Laser resectoscope 24/26 Fr</b>			
Outer sheath for resectoscope 26 FR	8675426	1	Urology/Laser enucleation
Inner sheath for resectoscope 24 FR	8675324	1	
Obturator for resectoscope 24 FR	8673024	1	
Viewing obturator for resectoscope 24 FR	8673124	1	
Dilatations obturator f. resectoscope 24 FR	8673224	1	
<b>Bipolar resectoscope 24/26 Fr</b>			
Working element, active, bipo 0/12/30	8680.205	1	Urology/Laser enucleation
Optional: working element, passive, bipo 0/12/30°	8680.225	1	
Cutting electrode bipo 24 FR 12/30°	4622.1313	1	
Coag. electrode bipo 24–26 FR 12/30°	4623.0223	1	
HF bipolar connection cable L 3 m	8108.232	1	
HF bipolar connection cable L 5 m	8108.252	1	
HF bipolar connection cable L 3 m	8108.231	1	
HF bipolar connection cable L 3 m	8108.251	1	
<b>Morcescope</b>			
Morcescope 0° 24 FR WL 199 mm	8970407	1	Urology/Laser enucleation
Autom. sealing element ID 5.7 mm	8920.311	1	
Pressure ball	103.00	1	
Tube with LUER-LOCK connector	886.00	1	
Cleaning brush Ø 11 mm TL 360 mm	6.01	1	
Also:			
Fiber light cable bndl Ø 3.5 mm, 2.3 m long	806635231	1	
Perforated basket for Morcescope with small part basket	38012	1	
<b>Note:</b> Can also be combined with monopolar working elements, electrodes, and HF cables, of course.			

IX23 | Subject to modifications. Please note that some products may not be available in all countries. Please always take note of the information that is provided with the product. For more detailed information, please consult with your contact partner or directly with Richard Wolf GmbH.

# TELESCOPES

## OVERVIEW

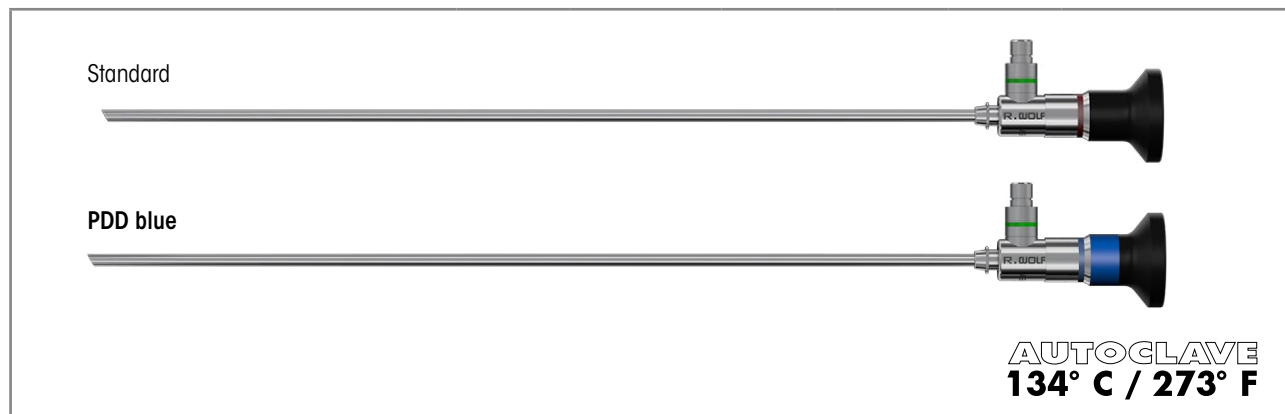

	Direction of view	Color coding	Ø	WL	TL	Product no.
Telescope 0° Ø 4 mm WL 298 mm	0°	Blue	4.0 mm	298 mm	365 mm	<b>8650.414</b>
Telescope blue 0° Ø 4 mm WL 298 mm				298 mm		<b>8650.514**</b>
Telescope 12° Ø 4 mm WL 297 mm	12°	Orange	4.0 mm	297 mm	363 mm	<b>8654.431</b>
Telescope blue 12° Ø 4 mm WL 298 mm				298 mm		<b>8654.531**</b>
Telescope 30° Ø 4 mm WL 300 mm	30°	Red	4.0 mm	300 mm	364 mm	<b>8654.422</b>
Telescope blue 30° Ø 4 mm WL 299 mm				299 mm		<b>8654.522**</b>
Telescope 30° Ø 3.3 mm WL 299 mm				299 mm		<b>8656.422</b>
Telescope 25° Ø 4 mm WL 342 mm	25°		4.0 mm	342 mm	404 mm	<b>8668.433*</b>
Telescope 70° Ø 4 mm WL 302 mm	70°	Yellow	4.0 mm	302 mm	364 mm	<b>8650.415</b>
Telescope blue 70° Ø 4 mm WL 303 mm				303 mm		<b>8650.515**</b>

\* Only available in 25°.

\*\* We have adapted our PANOVIEW telescopes to our new, high-performance blue PDD system.

The PANOVIEW telescopes are marked "blue" to distinguish them and they can also be used with your existing PDD system, of course.

Recommended accessories		Product no.
<b>Perforated basket for standard telescope 2</b>	Internal dimensions (W x H x D): 454 x 52 x 40 mm External dimensions (W x H x D): 481 x 54 x 59 mm	<b>38016</b>
<b>Fiber light cable bndl</b> consisting of: Fiber light cable (80662523), projector-side adapter (8095.07), and endoscope-side adapter (809509)	Ø 2.5 mm, 2.3 m long	<b>806625231</b>

# OPTICAL URETHROTOME 8667





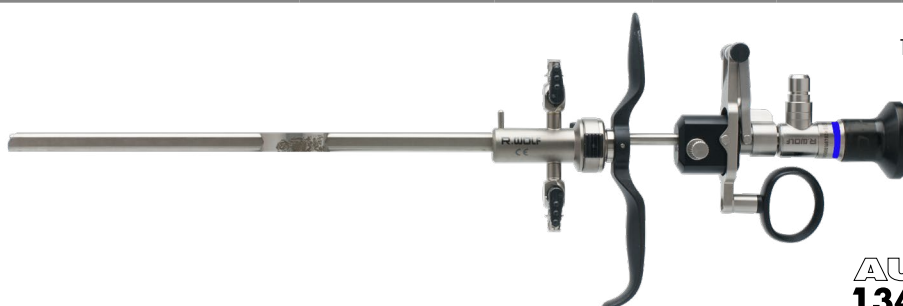

*E-line*

FOR TELESCOPE 4 MM, 0°



12 o'clock cutting position









**AUTOCLAVE**  
**134° C / 273° F**

for optically controlled slitting of urethral strictures.					Product no.
<b>Sheath for urethrotome 20.5 FR</b> SL 195 mm, with instrument port for lateral catheter insertion (4 Fr)					<b>8667.011</b>
<b>Obturator for urethrotome 20.5 FR</b> WL 231 mm, oval, cannulated, distal end rounded					<b>8667.111</b>
<b>Outer sheath for urethrotome 20.5 FR</b> SL 187 mm, oval, laterally open, for placing a 16 Fr balloon catheter					<b>8667.161</b>
<b>Adapter for cystoscope</b> with 1 instrument port, max. capacity 10 Fr, TL 79 mm					<b>8652.264</b>
<b>Working element, urethrotome, passive 0/12°</b> Receptacle for stricture scalpels					<b>8667.911</b>
<b>Also:</b> 					
Telescope	Direction of view	Ø	WL	TL	Product no.
Telescope 0° Ø 4 mm WL 298 mm	0°	4 mm	298 mm	365 mm	<b>8650.414</b>
					
Recommended accessories					Product no.
<b>Perforated basket for standard telescope 2</b>		Internal dimensions (W x H x D): 454 x 52 x 40 mm External dimensions (W x H x D): 481 x 54 x 59 mm			<b>38016</b>
<b>Fiber light cable bndl</b> consisting of: Fiber light cable (80662523), projector-side adapter (8095.07), and endoscope-side adapter (809509)		Ø 2.5 mm, 2.3 m long			<b>806625231</b>
<b>Stricture scalpels</b>					<b>see UR021</b>

IX23 | Subject to modifications. Please note that some products may not be available in all countries. Please always take note of the information that is provided with the product. For more detailed information, please consult with your contact partner or directly with Richard Wolf GmbH.



## STRICTURE SCALPELS FOR OPTICAL URETHROTOME 8667

Stricture scalpels with ceramic cutter		Cutting edge	Product no.
 Solid sheath	Scalpel 20.5 FR ceramic, semi-circular	Semi-circular	<b>8667.961</b>
 Sheath with central bore hole (for 4 Fr ureteral catheter)	Scalpel 20.5 FR ceramic, semi-circular	Semi-circular	<b>8667.966</b>
 Sheath with central bore hole (for 4 Fr ureteral catheter)	Scalpel 20.5 FR ceramic, shark fin	Shark fin for narrow stenoses	<b>8667.971</b>
 Solid sheath	Scalpel 20.5 FR ceramic, lancet-shaped	Lancet-shaped	<b>8667.981</b>
Stricture scalpels (steel)		Cutting edge	Product no.
 Sheath with central bore hole (for 4 Fr ureteral catheter)	Scalpel 20.5 FR, semi-circular	Semi-circular	<b>8667.965</b>
 Solid sheath	Scalpel 20.5 FR, semi-circular	Semi-circular	<b>8667.96</b>
 Solid sheath	Scalpel 20.5 FR, lancet-shaped	Lancet-shaped	<b>8667.98</b>
 Solid sheath	Scalpel 20.5 FR, sickle-shaped	Sickle-shaped	<b>8667.93</b>





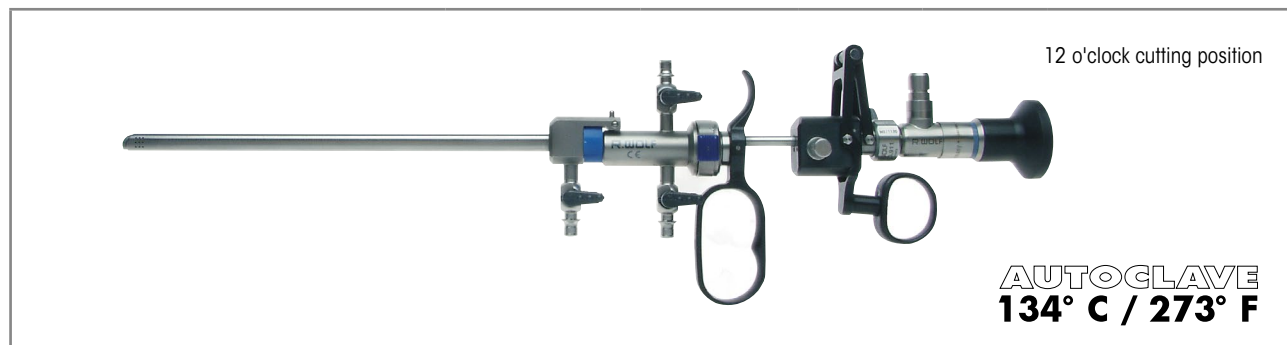

Recommended accessories		Product no.
<b>Protective sterilization sleeve</b> Receptacle for max. 5 electrodes, reusable	 <b>AUTOCLAVE</b> <b>134° C / 273° F</b>	<b>33030</b>

# OPTICAL MINI URETHROTOME

*E-line*

FOR TELESCOPE 3.3 MM, 0°





for optically controlled slitting of urethral strictures.					Product no.
<b>Sheath for urethrotome 16.5 FR</b> with supply and drain stopcock, lateral instrument port (4 Fr), distal end slanted, and automatic lock					<b>8670.011</b>
<b>Obturator for urethrotome 16.5 FR</b> Oval, cannulated, distal end rounded					<b>8670.111</b>
<b>Outer sheath for urethrotome 16.5 FR</b> Oval, laterally open, for placing a 16 Fr balloon catheter					<b>8670.061</b>
<b>Outer sheath for urethrotome 16.5 FR</b> Oval, laterally open, for placing a 12 Fr balloon catheter					<b>8670.161</b>
<b>Working element, urethrotome, passive 0°</b> Receptacle for stricture scalpels					<b>8670.911</b>
Also: 					
Telescope	Direction of view	Ø	WL	TL	Product no.
Telescope 0° Ø 3.3 mm WL 297 mm	0°	3.3 mm	297 mm	362 mm	<b>8660.424</b>



Recommended accessories		Product no.
<b>Perforated basket for standard telescope 2</b>	Internal dimensions (W x H x D): 454 x 52 x 40 mm External dimensions (W x H x D): 481 x 54 x 59 mm	<b>38016</b>
<b>Fiber light cable bndl</b> consisting of: Fiber light cable (80662523), projector-side adapter (8095.07), and endoscope-side adapter (809509)	Ø 2.5 mm, 2.3 m long	<b>806625231</b>
<b>Stricture scalpels</b>		see URO23

## STRICTURE SCALPELS FOR OPTICAL MINI URETHROTOME 8670

Stricture scalpels with ceramic cutter		Cutting edge	Product no.
 Solid sheath	<b>Scalpel 16.5 FR ceramic, semi-circular</b>	Semi-circular	<b>8670.961</b>
 Sheath with central bore hole (for 4 Fr ureteral catheter)	<b>Scalpel 16.5 FR ceramic, semi-circular</b>	Semi-circular	<b>8670.966</b>
 Sheath with central bore hole (for 4 Fr ureteral catheter)	<b>Scalpel 20.5 FR ceramic, lancet-shaped</b>	Lancet-shaped	<b>8670.981</b>

Recommended accessories		Product no.
<b>Protective sterilization sleeve</b> Receptacle for max. 5 electrodes, reusable	 <b>AUTOCLAVE</b> <b>134° C / 273° F</b>	<b>33030</b>

**URETHROTOME  
FOR BLIND SLITTING**

URETHROTOME

1.3

12 o'clock cutting position







Straight tip



Curved tip



Ball-shaped tip

	Fr	WL	Product no.
<p><b>Urethrotome 15–45 FR WL 236 mm</b></p> <p>Otis, with 3 exchangeable tips (straight, curved, and ball-shaped)</p>	15–45	236 mm	<b>8517.00</b>
<p><b>Knife</b> for urethrotome</p> 			<b>8517.90</b>

IX23 || Subject to modifications. Please note that some products may not be available in all countries. Please always take note of the information that is provided with the product. For more detailed information, please consult with your contact partner or directly with Richard Wolf GmbH.

# CYSTO-URETHROSCOPE 8650

*E-line*

SHEATH SYSTEMS FOR TELESCOPE 4 MM, 0°, 12°, 30°, 70°, AND ADAPTERS

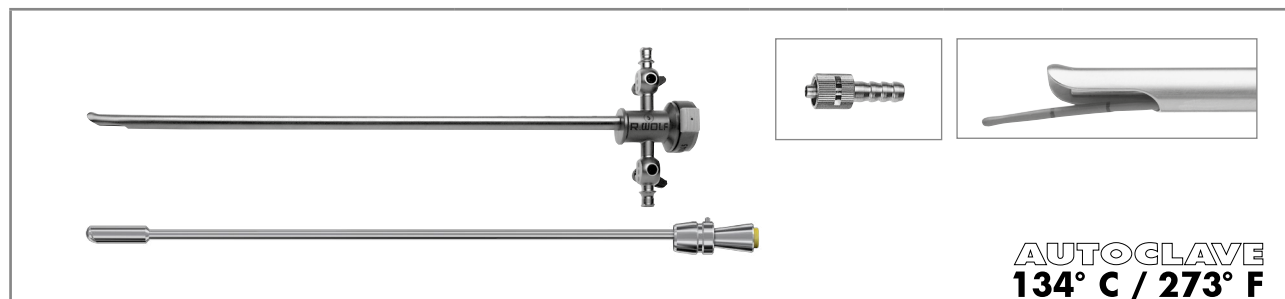

**AUTOCLAVE**  
**134° C / 273° F**

Sheath for cystoscope bndl	Fr	Color coding	SL	Capacity in Fr	Product no.
<b>Sheath for cystoscope 16 FR</b> comprising: Sheath for cystoscope 16 FR (8650.0145), obturator for cystoscope 16 FR (8650.0147), and tube with LUER-LOCK connector (886.00)	16 Fr	Yellow	231 mm	1 x 5*	<b>8650.0141</b>
<b>Sheath for cystoscope 17.5 FR</b> comprising: Sheath for cystoscope 17.5 FR (8650.0245), obturator for cystoscope 17.5 FR (8650.0247), and tube with LUER-LOCK connector (886.00)	17.5 Fr	Green		1 x 5 or 2 x 4	<b>8650.0241</b>
<b>Sheath for cystoscope 19.5 FR</b> comprising: Sheath for cystoscope 19.5 FR (8650.0345), obturator for cystoscope 19.5 FR (8650.0347), and tube with LUER-LOCK connector (886.00)	19.5 Fr	Red		1 x 7 or 2 x 5	<b>8650.0341</b>
<b>Sheath for cystoscope 21 FR</b> comprising: Sheath for cystoscope 21 FR (8650.0445), obturator for cystoscope 21 FR (8650.0447), and tube with LUER-LOCK connector (886.00)	21 Fr	Blue		1 x 10 or 2 x 6	<b>8650.0441</b>
<b>Sheath for cystoscope 23 FR</b> comprising: Sheath for cystoscope 16 FR (8650.0545), obturator for cystoscope 16 FR (8650.0547), and tube with LUER-LOCK connector (886.00)	23 Fr	White		1 x 12 or 2 x 7	<b>8650.0541</b>
<b>Sheath for cystoscope 25 FR</b> comprising: Sheath for cystoscope 25 FR (8650.0645), obturator for cystoscope 25 FR (8650.0647), and tube with LUER-LOCK connector (886.00)	25 Fr	Black		1 x 5	<b>8650.0641</b>

\* Urethrosopic only (cystoscopic only suitable for diagnostics via adapter 8650.254)

Also:

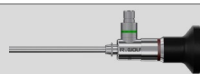

PANOVIEW	Direction of view	Ø	WL	TL	Product no.
Telescope 0° Ø 4 mm WL 298 mm	0°	4 mm	298 mm	365 mm	<b>8650.414</b>
Telescope 12° Ø 4 mm WL 297 mm	12°		297 mm	363 mm	<b>8654.431</b>
Telescope 30° Ø 4 mm WL 300 mm	30°		300 mm	364 mm	<b>8654.422</b>
Telescope 70° Ø 4 mm WL 302 mm	70°		302 mm	364 mm	<b>8650.415</b>
Telescope blue 0° Ø 4 mm WL 298 mm	0°	4 mm	298 mm	365 mm	<b>8650.514</b>
Telescope blue 12° Ø 4 mm WL 298 mm	12°		298 mm	363 mm	<b>8654.531</b>
Telescope blue 30° Ø 4 mm WL 299 mm	30°		299 mm	364 mm	<b>8654.522</b>
Telescope blue 70° Ø 4 mm WL 303 mm	70°		303 mm	362 mm	<b>8650.515</b>

for individual adapters/sheaths and obturators, see URO26 / for accessories, see URO29–URO30

# CYSTO-URETHROSCOPE 8650

*E-line*

SHEATH SYSTEMS FOR TELESCOPE 4 MM, 0°, 12°, 30°, 70°, AND ADAPTERS

CYSTO-URETHROSCOPE 8650

1.4

Individual sheaths and obturators					Adapters for cystoscope		
					 Only for diagnostics	 1 instrument port	 2 instrument ports
Individual sheath and obturator	Fr	SL/WL	Color coding	Product no.	Adapter for cystoscope TL 60 mm	Adapter for cystoscope TL 60 mm	Adapter for cystoscope TL 60 mm
Sheath for cystoscope 16 FR	16 Fr	SL 231 mm	Yellow	<b>8650.0145</b>	<b>8650.254</b>	<b>8650.264</b>	<b>8650.284</b>
Obturator for cystoscope 16 FR		WL 249 mm		<b>8650.0147</b>			
Sheath for cystoscope 17.5 FR	17.5 Fr	SL 231 mm	Green	<b>8650.0245</b>			
Obturator for cystoscope 17.5 FR		WL 249 mm		<b>8650.0247</b>			
Sheath for cystoscope 19.5 FR	19.5 Fr	SL 231 mm	Red	<b>8650.0345</b>			
Obturator for cystoscope 19.5 FR		WL 251 mm		<b>8650.0347</b>			
Sheath for cystoscope 21 FR	21 Fr	SL 231 mm	Blue	<b>8650.0445</b>			
Obturator for cystoscope 21 FR		WL 249 mm		<b>8650.0447</b>			
Sheath for cystoscope 23 FR	23 Fr	SL 231 mm	White	<b>8650.0545</b>			
Obturator for cystoscope 23 FR		WL 249 mm		<b>8650.0547</b>			
Sheath for cystoscope 25 FR	25 Fr	SL 231 mm	Black	<b>8650.0645</b>			
Obturator for cystoscope 25 FR		WL 249 mm		<b>8650.0647</b>			
Recommended accessories					Product no.		
Perforated basket for standard telescope 2				Internal dimensions (W x H x D): 454 x 52 x 40 mm External dimensions (W x H x D): 481 x 54 x 59 mm	<b>38016</b>		
Fiber light cable bndl consisting of: Fiber light cable (80662523), projector-side adapter (8095.07), and endoscope-side adapter (809509)				Ø 2.5 mm, 2.3 m long	<b>806625231</b>		

IX23 | Subject to modifications. Please note that some products may not be available in all countries. Please always take note of the information that is provided with the product. For more detailed information, please consult with your contact partner or directly with Richard Wolf GmbH.

# CYSTO-URETHROSCOPE 8650

*E-line*

SHEATH SYSTEMS FOR TELESCOPE 4 MM, 30°, 70°, AND INSERTS WITH ALBARRÁN LEVER

CYSTO-URETHROSCOPE 8650

1.4

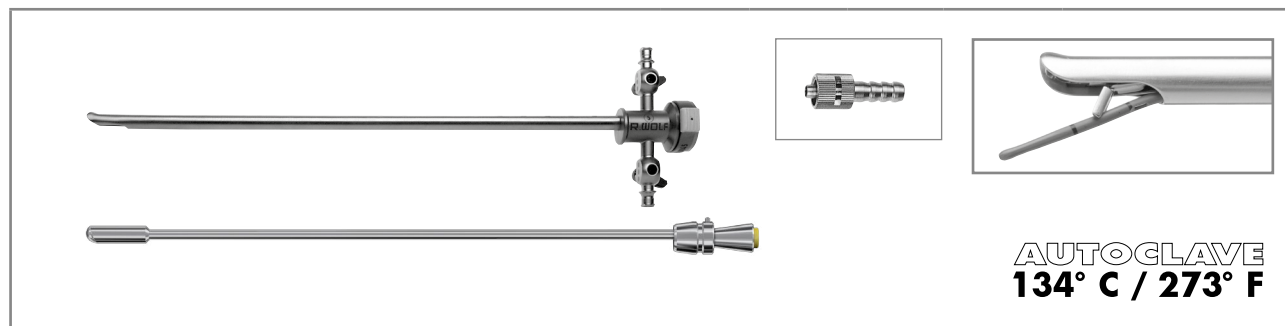

Sheath for cystoscope bndl	Fr	Color coding	SL	Capacity in Fr	Product no.
<b>Sheath for cystoscope 17.5 FR</b> comprising: Sheath for cystoscope 17.5 FR (8650.0245), obturator for cystoscope 17.5 FR (8650.0247), and tube with LUER-LOCK connector (886.00)	17.5 Fr	Green	231 mm	1 x 5 or 2 x 4	<b>8650.0241</b>
<b>Sheath for cystoscope 19.5 FR</b> comprising: Sheath for cystoscope 19.5 FR (8650.0345), obturator for cystoscope 19.5 FR (8650.0347), and tube with LUER-LOCK connector (886.00)	19.5 Fr	Red		1 x 7 or 2 x 5	<b>8650.0341</b>
<b>Sheath for cystoscope 21 FR</b> comprising: Sheath for cystoscope 21 FR (8650.0445), obturator for cystoscope 21 FR (8650.0447), and tube with LUER-LOCK connector (886.00)	21 Fr	Blue		1 x 10 or 2 x 6	<b>8650.0441</b>
<b>Sheath for cystoscope 23 FR</b> comprising: Sheath for cystoscope 16 FR (8650.0545), obturator for cystoscope 16 FR (8650.0547), and tube with LUER-LOCK connector (886.00)	23 Fr	White		1 x 12 or 2 x 7	<b>8650.0541</b>

Also:



PANOVIEW	Direction of view	Ø	WL	TL	Product no.
Telescope 30° Ø 4 mm WL 300 mm	30°		300 mm	364 mm	<b>8654.422</b>
Telescope 70° Ø 4 mm WL 302 mm	70°		302 mm	364 mm	<b>8650.415</b>
Telescope blue 30° Ø 4 mm WL 299 mm	30°		299 mm	364 mm	<b>8654.522</b>
Telescope blue 70° Ø 4 mm WL 303 mm	70°		303 mm	362 mm	<b>8650.515</b>

for individual adapters/sheaths and obturators, see URO28

Recommended accessories	Product no.
<b>Perforated basket for standard telescope 2</b>	<b>38016</b>
<b>Fiber light cable bndl</b> consisting of: Fiber light cable (80662523), projector-side adapter (8095.07), and endoscope-side adapter (809509)	<b>806625231</b>





# CYSTO-URETHROSCOPE 8650

*E-line*

SHEATH SYSTEMS FOR TELESCOPE 4 MM, 30°, 70°, AND INSERTS WITH ALBARRÁN LEVER

CYSTO-URETHROSCOPE 8650

1.4







Individual sheaths and obturators						
					 <p>1 instrument port</p>	 <p>2 instrument ports</p>
Individual sheath and obturator	Fr	SL/WL	Color coding	Product no.	Working insert for cystoscope 30/70	Working insert for cystoscope 0/30/70
Sheath for cystoscope 17.5 FR	17.5 Fr	SL 231 mm	Green	<b>8650.0245</b>	<b>8650.214</b>	<b>8650.204</b>
Obturator for cystoscope 17.5 FR		WL 249 mm		<b>8650.0247</b>		
Sheath for cystoscope 19.5 FR	19.5 Fr	SL 231 mm	Red	<b>8650.0345</b>		
Obturator for cystoscope 19.5 FR		WL 251 mm		<b>8650.0347</b>		
Sheath for cystoscope 21 FR	21 Fr	SL 231 mm	Blue	<b>8650.0445</b>		
Obturator for cystoscope 21 FR		WL 249 mm		<b>8650.0447</b>		
Sheath for cystoscope 23 FR	23 Fr	SL 231 mm	White	<b>8650.0545</b>		
Obturator for cystoscope 23 FR		WL 249 mm		<b>8650.0547</b>		

IX23 || Subject to modifications. Please note that some products may not be available in all countries. Please always take note of the information that is provided with the product. For more detailed information, please consult with your contact partner or directly with Richard Wolf GmbH.

## OPTICAL FORCEPS AND SCISSORS

FOR CYSTO-URETHROSCOPE 8650  
WITH TELESCOPE 4 MM, 0°



			Suitable for sheaths from	Product no.
	<b>Opt. biopsy forceps, spoon-shaped</b>		19.5 Fr	<b>8650.604</b>
	<b>Opt. grasping forceps, straight</b>		19.5 Fr	<b>8650.684</b>
	<b>Opt. biopsy forceps, "Marburg" model</b>	Short distance between jaw section and telescope means biopsies can be taken from the area around the bladder neck	19.5 Fr	<b>8650.614</b>
	<b>Opt. biopsy forceps, spoon curved downward</b>	for taking biopsies from the transition area between the bladder neck and roof, and from the area at the back of the urethra	19.5 Fr	<b>8650.774</b>
	<b>Opt. scissors, "Wuppertal" model, curved downward</b>	for opening uretero cells, cutting through migrated sutures, and removing polyps from the base, and for ostium slitting	19.5 Fr	<b>8650.644</b>
	<b>Opt. grasping forceps curved downward</b>	for crushing small, soft stones	19.5 Fr	<b>8650.654</b>
	<b>Opt. stone grasping forceps curved downward</b>	for small stones, for processing stone fragments	23 Fr	<b>8650.664</b>



			Suitable for sheaths from	Product no.
<b>for cysto-urethroscope 8650 with telescope 4 mm, 0°</b>				
	<b>Opt. coag. biopsy forceps Tauber</b>	for combined biopsy and hemostasis. Particularly suitable for bladder mapping and quadrant biopsies. Immediate hemostasis without changing instruments or performing a time-consuming reorientation.	21 Fr	<b>8650.624</b>

## VIEWING OBTURATORS

FOR INSERTING THE SHEATH WHILE VIEWING FOR 4 MM TELESCOPES FROM 0° TO 30°

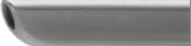
				
for inserting the sheath while viewing for 4 mm telescopes from 0° to 30°		WL	Suitable for Sheath	Product no.
 distal end rounded	Viewing obturator for cystoscope 17.5 FR	249 mm	17.5 Fr	<b>8650.714</b>
	Viewing obturator for cystoscope 19.5 FR		19.5 Fr	<b>8650.724</b>
	Viewing obturator for cystoscope 21 FR		21 Fr	<b>8650.734</b>
	Viewing obturator for cystoscope 23 FR		23 Fr	<b>8650.744</b>

Recommended accessories	Product no.
HF connection cable	see UR0103/104

# MIDI-SIZE

## CYSTO-URETHROSCOPE

"MIDI-SIZE" CYSTO-URETHROSCOPE

1.5

for smaller anatomies



**AUTOCLAVE**  
134° C / 273° F

Sheath for cystoscope bndl	consisting of:	Fr	Capacity in Fr	Color coding	Product no.
<b>Sheath for cystoscope 12.5 FR</b> with 2 irrigation valves	Sheath for cystoscope 12.5 FR (86720255), obturator for cystoscope 12.5 FR (86720257), and tube with LUER-LOCK connector (886.00)	12.5	5	Green	<b>86720251</b>
<b>Sheath for cystoscope 14.5 FR</b> with 2 irrigation valves	Sheath for cystoscope 14.5 FR (86720455), obturator for cystoscope 14.5 FR (86720457), and tube with LUER-LOCK connector (886.00)	14.5	7	Green	<b>86720451</b>

**Also: individual sheaths and obturators**



Individual sheath and obturator	SL/WL	Color coding	Product no.	Adapter for cystoscope TL 65 mm
<b>Sheath for cystoscope 12.5 FR</b>	SL 193 mm	Green	<b>86720255</b>	<b>8672265</b>
<b>Obturator for cystoscope 12.5 FR</b>	WL 211 mm	Green	<b>86720257</b>	
<b>Sheath for cystoscope 14.5 FR</b>	SL 194 mm	White	<b>86720455</b>	
<b>Obturator for cystoscope 14.5 FR</b>	WL 211 mm	White	<b>86720457</b>	

Also:



	Ø	WL	TL	Product no.
<b>Telescope 30° Ø 2.7 mm WL 267 mm</b>	2.7 mm	267 mm	331 mm	<b>8672432</b>



**Recommended accessories**

Product no.

<b>Perforated basket for standard telescope 2</b>	Internal dimensions (W x H x D): 454 x 52 x 40 mm External dimensions (W x H x D): 481 x 54 x 59 mm	<b>38016</b>
<b>Fiber light cable bndl</b> consisting of: Fiber light cable (80662523), projector-side adapter (8095.07), and endoscope-side adapter (809509)	Ø 2.5 mm, 2.3 m long	<b>806625231</b>
<b>HF connection cable</b>		see UR0103/104

## MIDI-SIZE

### FLEXIBLE AUXILIARY INSTRUMENTS

		WL	TL	Fr	Product no.
	Flex. biopsy forceps 5 FR WL 315 mm	315 mm	465 mm	5	<b>829.05</b>
	Flex. biopsy forceps 7 FR WL 375 mm	375 mm	490 mm	7	<b>829.07</b>
	Flex. grasping forceps 5 FR WL 315 mm	315 mm	465 mm	5	<b>828.05</b>
	Flex. grasping forceps 7 FR WL 365 mm	365 mm	515 mm	7	<b>828.07</b>
	Flex. scissors 7 FR WL 375 mm	375 mm	490	7	<b>830.07</b>

IX23 || Subject to modifications. Please note that some products may not be available in all countries. Please always take note of the information that is provided with the product. For more detailed information, please consult with your contact partner or directly with Richard Wolf GmbH.



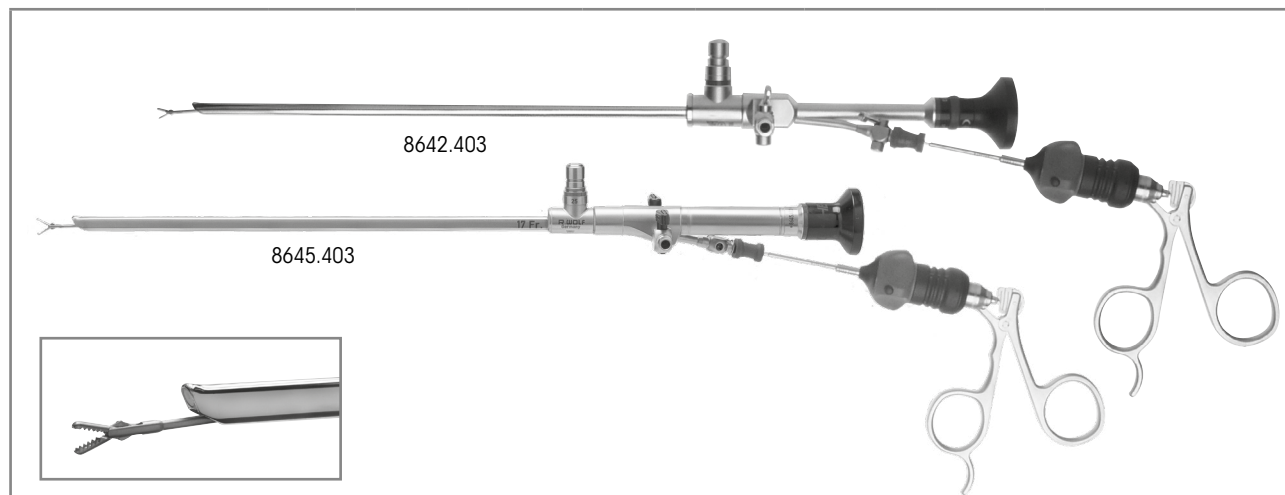

# ATRAUMATIC COMPACT CYSTO-URETHROSCOPE

## 14/17 FR, 25° AND ADAPTERS



	Direction of view	WL	TL	Sheath	Working channel		Product no.
					for auxiliary instruments	Shape	
<b>Cystoscope 25° 14 FR WL 218 mm</b> with straight eyepiece, atraumatically shaped tip	25°	218 mm	358 mm	14 Fr	Up to 5 Fr	Oval	<b>8642.403</b>
<b>Cystoscope 25° 17 FR WL 224 mm</b> with straight eyepiece, atraumatically shaped tip	25°	224 mm	364 mm	17 Fr	Up to 7 Fr	Oval	<b>8645.403</b>

Also:

		WL	TL	Fr	Product no.
	Flex. biopsy forceps 7 FR WL 375 mm	375 mm	490 mm	7	<b>829.07</b>
	Flex. biopsy forceps 5 FR WL 315 mm	315 mm	465 mm	5	<b>829.05</b>
	Flex. grasping forceps 7 FR WL 365 mm	365 mm	515 mm	7	<b>828.07</b>
	Flex. grasping forceps 5 FR WL 315 mm	315 mm	465 mm	5	<b>828.05</b>
	Flex. scissors 7 FR WL 375 mm	375 mm	490 mm	7	<b>830.07</b>
	Coag. electrode mono 6 FR WL 400 mm	400 mm	-	6	<b>823.06</b>
	Coag. electrode mono 5 FR WL 400 mm	400 mm	-	5	<b>823.05</b>

Recommended accessories

Product no.

<b>Perforated basket for cysto-urethroscope</b>	Internal dimensions (W x H x D): 435 x 54 x 73 mm External dimensions (W x H x D): 451 x 64 x 80 mm	<b>38013</b>
<b>Fiber light cable bndl</b> consisting of: Fiber light cable (80662523), projector-side adapter (8095.07), and endoscope-side adapter (809509)	Ø 2.5 mm, 2.3 m long	<b>806625231</b>









# FORCEPS AND SCISSORS

SMALL MODULAR SYSTEM **HySafe**

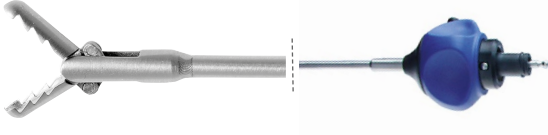
FOR ATRAUMATIC COMPACT CYSTO-URETHROSCOPES 14/17 FR, 25°

ATRAUMATIC COMPACT CYSTO-URETHROSCOPE

1.6

Grasping forceps jaw insert with sheath				Handle with overload protection	Complete instrument • Jaw section • Handle
	Product no.	Fr	WL	8083.001	Product no.
<b>Grasping forceps bndl</b> Distal angled with pike-mouth jaws 	8642.6508	5	340 mm	•	<b>8642.6502</b>
	8645.6508	7	325 mm	•	<b>8645.6502</b>
<b>Grasping forceps bndl</b> - Spoon 	8642.6008	5	340 mm	•	<b>8642.6002</b>
	8645.6008	7	340 mm	•	<b>8645.6002</b>
<b>Biopsy forceps bndl</b> 	8642.6318	5	340 mm	•	<b>8642.6312</b>
<b>Scissors bndl</b> 	8642.6818	5	340 mm	•	<b>8642.6812</b>
<b>Grasping forceps bndl</b> 	8968.6808	6	425 mm	•	<b>8968.6802</b>

IX23 || Subject to modifications. Please note that some products may not be available in all countries. Please always take note of the information that is provided with the product. For more detailed information, please consult with your contact partner or directly with Richard Wolf GmbH.

# FLEXIBLE FIBER CYSTOSCOPES 5 MM/15 FR

## CHANNEL 2.5 MM/7.5 FR

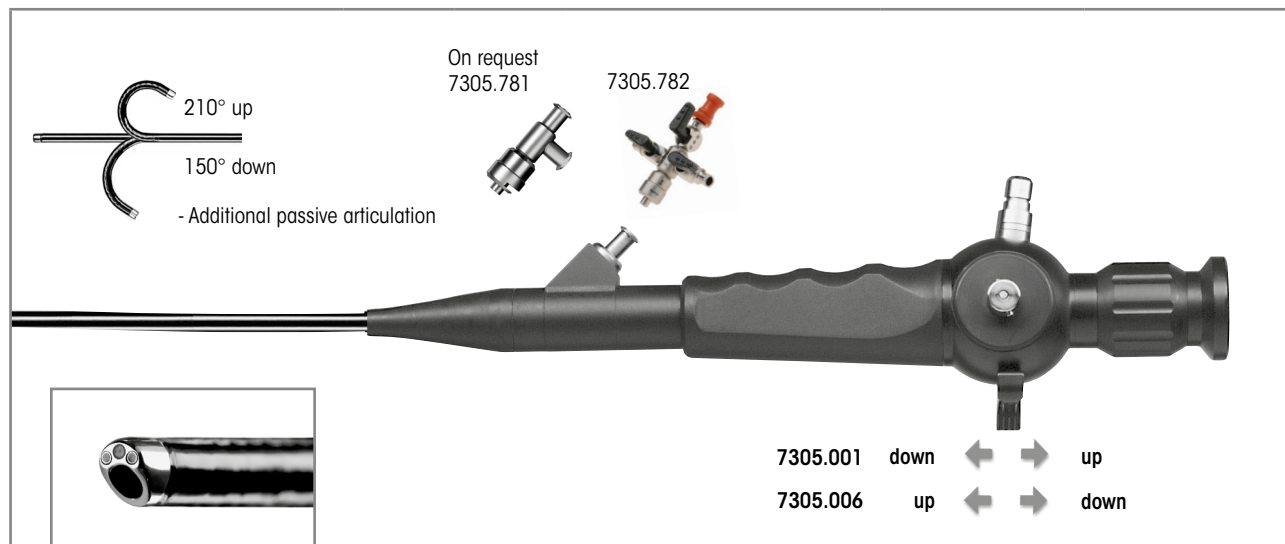

	Outer Ø	Working channel	WL	Control lever in distal direction – articulation downward	Control lever in distal direction – articulation upward	Product no.
<b>Fiber cystoscope 15 FR WL 400 mm</b>	15 Fr	7.5 Fr	400 mm	•		<b>7305.001</b>
Slanted distal tip Articulation +210°/-150° Direction of view 0°, angle of view 110°					•	<b>7305.006</b>
<b>Fiber cystoscope bndl</b> consisting of: Fiber cystoscope 15 FR WL 400 mm (7305.001) Adapter with 2 irrigation valves and 1 instrument port (7305.782) Leakage tester for flex. endoscopes (163.903) Pressure equalization valve (163.904) Cleaning brush Ø 3 mm, TL 1,200 mm (PU = 10 PCS) (7990002)				•		<b>730500111</b>
<b>Fiber cystoscope bndl</b> consisting of: Fiber cystoscope 15 FR WL 400 mm (7305.006) Adapter with 2 irrigation valves and 1 instrument port (7305.782) Leakage tester for flex. endoscopes (163.903) Pressure equalization valve (163.904) Cleaning brush Ø 3 mm, TL 1,200 mm (PU = 10 PCS) (7990002)					•	<b>730500611</b>









Recommended accessories		Product no.
<b>Fiber light cable bndl</b> consisting of: Fiber light cable Ø 2.5 mm, TL 2.3 m (80662523), projector-side adapter (8095.07), and endoscope-side adapter (809509)	Ø 2.5 mm, 2.3 m long	<b>806625231</b>
<b>Perforated basket for flexible endoscopes</b> Also: <b>fixing ring Ø 50.39 mm</b>	(W x H x D): 448 x 106 x 288 mm	<b>33016</b> <b>643301261</b>

IX23 || Subject to modifications. Please note that some products may not be available in all countries. Please always take note of the information that is provided with the product. For more detailed information, please consult with your contact partner or directly with Richard Wolf GmbH.

# FLEXIBLE FIBER CYSTOSCOPES 5 MM/15 FR

## TECHNICAL DATA/AUXILIARY INSTRUMENTS

Fiber cystoscope 15 FR WL 400 mm	7305.001/7305.006
Distal tip	Slanted distal tip
Sheath diameter	15 Fr
Number of working channels	1
Working/irrigation channel diameter	7.5 Fr
Articulation	210° upward, 150° downward
Working length	400 mm
Angle of view	110°
Direction of view	0°

Auxiliary instruments	Outer Ø	WL	TL	Product no.
 <b>Flex. biopsy forceps 5 FR WL 550 mm</b>	1.6 mm 5 Fr	550 mm	700 mm	<b>829.051</b>
 <b>Flex. grasping forceps 5 FR WL 550 mm</b>	1.6 mm 5 Fr	550 mm	680 mm	<b>8735.685</b>
 <b>Flex. grasping forceps 6.6 FR WL 550 mm</b>	2.0 mm 6.6 Fr	550 mm	690 mm	<b>8736.685</b>
 <b>Adapter</b> with 2 Luer connections, male, quick-release mechanism			36 mm	<b>7305.781</b>
 <b>Adapter</b> with 2 irrigation valves and 1 instrument port, quick-release mechanism			57 mm	<b>7305.782</b>
 Also: <b>Luer sealing cap</b>				<b>15023205</b>
 <b>RIWO rubber cap, capacity 0.8 mm</b>				<b>88.01</b>
 <b>Universal sealing valve 1–6 FR</b> for inserting auxiliary instruments of 1–6 Fr				<b>4712348</b>

# vision EF

## FLEXIBLE 1-CHANNEL SENSOR CYSTOSCOPES



	Outer Ø	Working channel	WL	Control lever in distal direction – articulation downward	Control lever in distal direction – articulation upward	Product no.
<b>Sensor cystoscope 16.2 FR</b> <b>WL 400 mm</b> Slanted distal tip Articulation +210°/-210° Direction of view 0°, angle of view 110°	16.2 Fr	7.5 Fr	400 mm	•		<b>73151001</b>
					•	<b>73151006</b>
<b>Sensor cystoscope bndl</b> consisting of: Sensor cystoscope 16.2 FR, WL 400 mm (73151001), leakage tester for flex. endoscopes (163.903), pressure equalization valve (163.904), Luer sealing cap (15023205), and cleaning brush Ø 5 mm, TL 1,200 mm (PU = 10 PCS) (7990005)				•		<b>731510012</b>
<b>Fiber cystoscope bndl</b> consisting of: Sensor cystoscope 16.2 FR, WL 400 mm (73151006), leakage tester for flex. endoscopes (163.903), pressure equalization valve (163.904), Luer sealing cap (15023205), and cleaning brush Ø 5 mm, TL 1,200 mm (PU = 10 PCS) (7990005)					•	<b>731510062</b>

Recommended accessories		Product no.
<b>Fiber light cable bndl</b> consisting of: Fiber light cable Ø 2.5 mm, TL 2.3 m (80662523), projector-side adapter (8095.07), and endoscope-side adapter (809509)	Ø 2.5 mm, 2.3 m long	<b>806625231</b>
<b>Perforated basket for flexible endoscopes</b> Also: <b>fixing ring Ø 50.39 mm</b> 	(W x H x D): 448 x 106 x 288 mm	<b>33016</b>
		<b>643301261</b>
<b>Flexible auxiliary instruments</b>		see UR039







# vision EF FLEXIBLE SENSOR CYSTOSCOPES

## TECHNICAL DATA

Sensor cystoscope 16.2 FR WL 400 mm	73151001/73151006
Distal tip	Cylindrical, atraumatic, slanted plastic tip 11.5 Fr
Sheath diameter	16.2 Fr
Number of working channels	1
Working/irrigation channel diameter	7.5 Fr
Articulation	210° upward, 210° downward
Working length	400 mm
Angle of view	110°
Illumination	Two distally integrated LEDs
Handle	Ergonomic handle design with axial cable outlet
Positioning of the working and irrigation channel in relation to the picture	At 3 o'clock
Endopicture	Octagonal, detail enhancement, automatic white balance, and brightness control, no focusing necessary
Cable length	2.5 m

## vision EF FLEXIBLE SENSOR CYSTOSCOPES

### AUXILIARY INSTRUMENTS

		Outer Ø	WL	TL	Product no.
	<b>Flex. biopsy forceps 5 FR WL 550 mm</b>	1.6 mm 5 Fr	550 mm	700 mm	<b>829.051</b>
	<b>Flex. grasping forceps 5 FR WL 550 mm</b>	1.6 mm 5 Fr	550 mm	680 mm	<b>8735.685</b>
	<b>Adapter</b> with 2 irrigation valves and 1 instrument port, quick-release mechanism			57 mm	<b>7305.782</b>
	Also: <b>Luer sealing cap</b>				<b>15023205</b>
	<b>RIWO rubber cap, capacity 0.8 mm</b>				<b>88.01</b>
	<b>Universal sealing valve 1–6 FR</b> for inserting auxiliary instruments of 1–6 Fr				<b>4712348</b>
	<b>Adapter</b> for machine leakage tests				<b>163.905</b>

**mamba**  
VISION  
**FLEXIBLE SENSOR CYSTOSCOPES**  
FOR ENDOCAM **Logic 4K** CONTROLLER

"MAMBA" FLEXIBLE SENSOR CYSTOSCOPES

1.9



	Outer Ø	Working channel	WL	Control lever in distal direction – articulation downward	Control lever in distal direction – articulation upward	Product no.
<b>Sensor cystoscope 16.2 Fr WL 400 mm</b> Slanted distal tip Articulation +210°/-210° Direction of view 0°, angle of view 110°	16.2 Fr	7.5 Fr	400 mm	•		<b>7315001</b>
				•	<b>7315006</b>	
<b>Sensor cystoscope bndl</b> consisting of: Sensor cystoscope 16.2 FR, WL 400 mm (7315001), leakage tester for flex. endoscopes (163.903), pressure equalization valve (163.904), Luer sealing cap (15023205), and cleaning brush Ø 5 mm, TL 1,200 mm (PU = 10 PCS) (7990005)				•		<b>73150012</b>
<b>Sensor cystoscope bndl</b> consisting of: Sensor cystoscope 16.2 FR, WL 400 mm (7315006), leakage tester for flex. endoscopes (163.903), pressure equalization valve (163.904), Luer sealing cap (15023205), and cleaning brush Ø 5 mm, TL 1,200 mm (PU = 10 PCS) (7990005)					•	<b>73150062</b>
<b>Recommended accessories</b>						<b>Product no.</b>
<b>Fiber light cable bndl</b> consisting of: Fiber light cable Ø 2.5 mm, TL 2.3 m (80662523), projector-side adapter (8095.07), and endoscope-side adapter (809509)				Ø 2.5 mm, 2.3 m long		<b>806625231</b>
<b>Perforated basket for flexible endoscopes</b> Also: <b>fixing ring Ø 50.39 mm</b>				(W x H x D): 448 x 106 x 288 mm		<b>33016</b>
						<b>643301261</b>
<b>Flexible auxiliary instruments</b>						<b>see UR042</b>

IX23 || Subject to modifications. Please note that some products may not be available in all countries. Please always take note of the information that is provided with the product. For more detailed information, please consult with your contact partner or directly with Richard Wolf GmbH.



**mamba**  
VISION  
**FLEXIBLE SENSOR CYSTOSCOPE**

**TECHNICAL DATA**

Sensor cystoscope 16.2 Fr WL 400 mm	7315001/7315006
Distal tip	11.5 Fr, atraumatic tip made of plastic, two distally integrated LEDs
Sheath diameter	16.2 Fr
Number of working channels	1
Working/irrigation channel diameter	7.5 Fr
Articulation	210° upward, 210° downward
Working length	400 mm
Angle of view	110°
Handle	Ergonomic handle design with axial cable outlet
Positioning of the working and irrigation channel in relation to the picture	At 3 o'clock
Endopicture	Octagonal, 3 levels of detail magnification, and 6x digital zoom; automatic white balance, light control, and focus
Compatible camera control unit	ENDOCAM Logic 4K ENDOCAM Logic HD

"MAMBA" FLEXIBLE SENSOR CYSTOSCOPES

1.9







**Required video equipment**

**Product no.**



**ENDOCAM Logic 4K camera control unit bndl**  
consisting of:  
ENDOCAM Logic 4K camera control unit (5525301)  
Handheld remote control (5525401)  
1x USB flash memory 32 GB (72321829)  
1x HDMI/HDMI cable, lockable, 3.0 m (103847)  
1x power cable (2440.03)

**55253011**

		Outer Ø	WL	TL	Product no.
	<b>Flex. biopsy forceps 5 FR WL 550 mm</b>	1.6 mm 5 Fr	550 mm	700 mm	<b>829.051</b>
	<b>Flex. grasping forceps 5 FR WL 550 mm</b>	1.6 mm 5 Fr	550 mm	700 mm	<b>828.051</b>
	<b>Adapter</b> with 2 irrigation valves and 1 instrument port, quick-release mechanism			57 mm	<b>7305.782</b>
	Also: <b>Luer sealing cap</b>				<b>15023205</b>
	<b>RIWO rubber cap, capacity 0.8 mm</b>				<b>88.01</b>
	for inserting auxiliary instruments of 1–6 Fr <b>Universal sealing valve 1–6 FR</b>				<b>4712348</b>
	<b>Adapter for machine leakage tests</b>				<b>163.905</b>

# System blue

## SYSTEM COMPONENTS

### FOR PHOTODYNAMIC DIAGNOSTICS (PDD)

IX23 || Subject to modifications. Please note that some products may not be available in all countries. Please always take note of the information that is provided with the product. For more detailed information, please consult with your contact partner or directly with Richard Wolf GmbH.

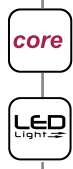

				Product no.
<b>ENDOLIGHT LED blue bndl</b> consisting of: ENDOLIGHT LED blue (5165001), patch cable, RJ45 SFTP, 0.5 m (72325378), toggle footswitch (2030.105), and power cable 3 m long (2440.03)				<b>51650011</b>
<b>ENDOCAM Logic 4K camera control unit bndl</b> consisting of: ENDOCAM Logic 4K camera control unit (5525301), handheld remote control (5525401), USB flash memory 32 GB (72321829), HDMI/HDMI cable, lockable, 3.0 m (103847), and power cable (2440.03)				<b>55253011</b>
<b>ENDOCAM Logic HD Pendual camera head blue</b> Cable length 3 m				<b>5525833</b>
<b>Also:</b>				
PANOVIEW	Ø	WL	TL	Product no.
Telescope blue 0° Ø 4 mm WL 298 mm	4.0 mm	298 mm	365 mm	<b>8650.514</b>
Telescope blue 12° Ø 4 mm WL 298 mm		298 mm	363 mm	<b>8654.531</b>
Telescope blue 30° Ø 4 mm WL 299 mm		299 mm	364 mm	<b>8654.522</b>
Telescope blue 70° Ø 4 mm WL 303 mm		303 mm	362 mm	<b>8650.515</b>
<b>Special fiber light cable 3.5 mm, 2.3 m set</b> consisting of: Fiber light cable blue Ø 3.5 mm (80673523), endoscope-side adapter (809509)	3.5 mm		2.3 m	<b>806735231</b>

"SYSTEM BLUE" FOR PHOTODYNAMIC DIAGNOSTICS (PDD)

1.10

# System blue

## SYSTEM COMPONENTS FOR PHOTODYNAMIC DIAGNOSTICS (PDD)

### CYSTOSCOPY

"SYSTEM BLUE" FOR PHOTODYNAMIC DIAGNOSTICS (PDD)

1.10

Cystoscopy		Product no.
<b>Recommendation:</b> PDD cysto-urethroscope with adapter		
	PANOVIEW telescope blue 70° Ø 4 mm WL 303 mm	<b>8650.515</b>
	Adapter for cystoscope	<b>8650.284</b>
	Sheath for cystoscope 19.5 FR	<b>8650.0341</b>
	Obturator for cystoscope 19.5 FR	<b>8650.0347</b>

IX23 || Subject to modifications. Please note that some products may not be available in all countries. Please always take note of the information that is provided with the product. For more detailed information, please consult with your contact partner or directly with Richard Wolf GmbH.

FOR RESECTOSCOPES

TELESCOPE 4 MM, 0°, 12°, 30°

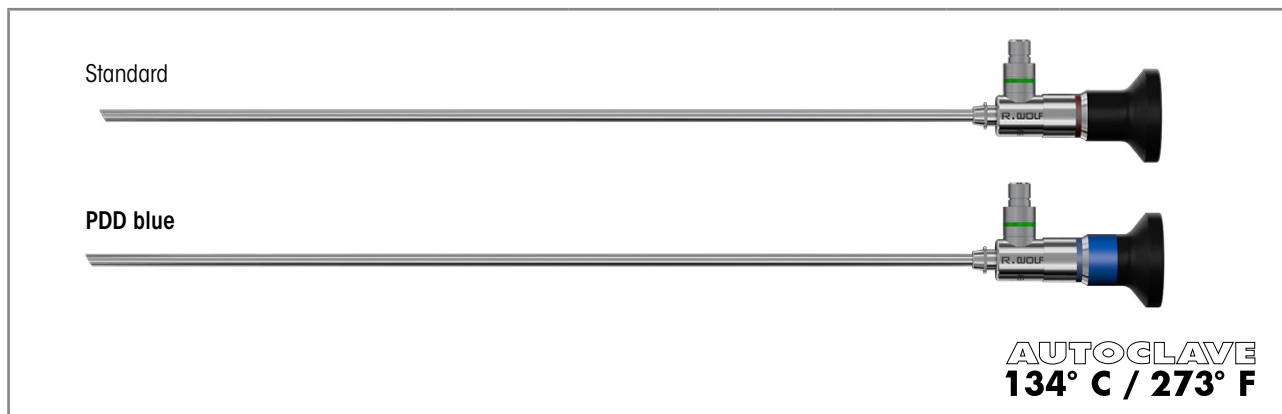

	Direction of view	Color coding	Ø	WL	TL	Product no.
Telescope 0° Ø 4 mm WL 298 mm	0°	Blue	4.0 mm	298 mm	365 mm	<b>8650.414</b>
Telescope blue 0° Ø 4 mm WL 298 mm				298 mm		<b>8650.514**</b>
Telescope 12° Ø 4 mm WL 297 mm	12°	Orange	4.0 mm	297 mm	363 mm	<b>8654.431</b>
Telescope blue 12° Ø 4 mm WL 298 mm				298 mm		<b>8654.531**</b>
Telescope 30° Ø 4 mm WL 300 mm	30°	Red	4.0 mm	300 mm	364 mm	<b>8654.422</b>
Telescope blue 30° Ø 4 mm WL 299 mm				299 mm		<b>8654.522**</b>
Telescope 30° Ø 3.3 mm WL 299 mm				3.3 mm		299 mm
Telescope 25° Ø 4 mm WL 342 mm	25°		4.0 mm	342 mm	404 mm	<b>8668.433*</b>
Telescope 70° Ø 4 mm WL 302 mm	70°	Yellow	4.0 mm	302 mm	364 mm	<b>8650.415</b>
Telescope blue 70° Ø 4 mm WL 303 mm				303 mm		364 mm

\* Only available in 25°.

\*\* We have adapted our PANOVIEW telescopes to our new, high-performance blue PDD system.

The PANOVIEW telescopes are marked "blue" to distinguish them and they can also be used with your existing PDD system, of course.

Recommended accessories		Product no.
Perforated basket for standard telescope 2	Internal dimensions (W x H x D): 454 x 52 x 40 mm External dimensions (W x H x D): 481 x 54 x 59 mm	<b>38016</b>
Fiber light cable bndl consisting of: Fiber light cable (80662523), projector-side adapter (8095.07), and endoscope-side adapter (809509)	Ø 2.5 mm, 2.3 m long	<b>806625231</b>

## OVERVIEW

"SHARK" RESECTOSCOPES (MONOPOLAR/BIPOLAR)

### Sheaths for continuous irrigation

CI Double sheath system	
Outer sheath	Inner sheath
8675424	8675322
-	-
8675426	8675324
-	-

### Sheaths for intermittent irrigation

II Sheath with rotatable irrigation adapter		
Rotatable irrigation adapter		
with 4 mm Luer connection	with 3 mm Luer connection, with stopcock	Sheath
-	-	-
8676354	8676361	8676324
-	-	-
8676354	8676361	8676326
Two-way stopcock 88351	Two-way stopcock 88350	

Sheath size	
CI	22/24 Fr
II	24 Fr
CI	24/26 Fr
II	26 Fr

### Monopolar working elements

Active		Passive	
Handle closed	Handle closed with comfort thumb rest	Handle open	Handle closed
8681205*	-	8681224*	-
8674205	8674234	8674224	8674225
Spare rubber cap, red (PU = 5 pcs) .....			8874
Thumb ring with relatively large inner diameter .....			15008.159



Direction of view
0°
12°
30°

CI = continuous irrigation II = intermittent irrigation

\* Not suitable for 22/24 Fr Double sheath system



IX23 II Subject to modifications. Please note that some products may not be available in all countries. For more detailed information, please consult with your contact partner or directly with Richard Wolf GmbH.

## Obturator

II Sheath with central stopcock	
	
Sheath	Connection part
-	-
8676424	8676342
-	-
8676426	8676343

Obturator	Viewing obturator	Dilatations obturator
		
		
8673022	8673122	-
8673024	8673124	8673224
8673026	8673126	8673226

## Telescopes, Ø 4 mm



Standard	PDD
	
8650.414	8650.514
8654.431	8654.531
8654.422	8654.522
Fiber light cable 2.5 mm 3.0 m set ..... 806625301	

## OVERVIEW

"SHARK" RESECTOSCOPES (MONOPOLAR/BIPOLAR)

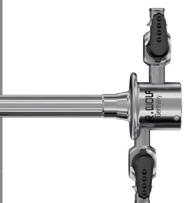
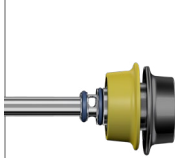

1.11

### Sheaths for continuous irrigation

CI Double sheath system	
	
Outer sheath	Inner sheath
	
8675424	8675322
-	-
8675426	8675324
-	-

Sheath size	
CI	22/24 Fr
II	24 Fr
CI	24/26 Fr
II	26 Fr

### Sheaths for intermittent irrigation

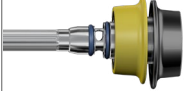
II Sheath with rotatable irrigation adapter		
		
Rotatable irrigation adapter with 4 mm Luer connection	Rotatable irrigation adapter with 3 mm Luer connection, with stopcock	Sheath
		
-	-	-
8676354	8676361	8676324
-	-	-
8676354	8676361	8676326
Two-way stopcock 88351	Two-way stopcock 88350	

### Bipolar working elements

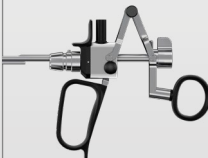
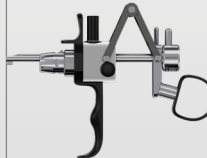
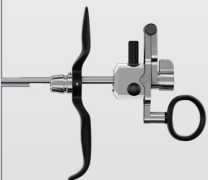
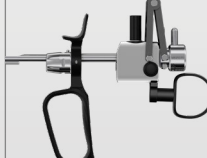
Active		Passive	
Handle closed	Handle open	Handle open	Handle closed
			
8680.205	8680.204	8680.224	8680.225
Spare rubber cap, black (PU = 5 pcs) ..... 8880			
Thumb ring with relatively large inner diameter ..... 15008.159			

Direction of view
0°
12°
30°





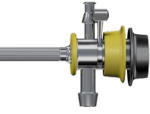

CI = continuous irrigation  
II = intermittent irrigation

IX23 || Subject to modifications. Please note that some products may not be available in all countries. For more detailed information, please consult with your contact partner or directly with Richard Wolf GmbH.





## Obturator

II Sheath with central stopcock	
	
Sheath	Connection part
-	-
8676424	8676342
-	-
8676426	8676343

Obturator	Viewing obturator	Dilatations obturator
		
		
8673022	8673122	-
8673024	8673124	8673224
8673026	8673126	8673226

## Telescopes, Ø 4 mm

Standard	PDD
	
8650.414	8650.514
8654.431	8654.531
8654.422	8654.522
Fiber light cable 2.5 mm 3.0 m set ..... 806625301	



# MONOPOLAR RESECTOSCOPE

FOR TELESCOPE 4 MM, 0°, 12°, 30°  
WITH CONTINUOUS IRRIGATION DOUBLE SHEATH SYSTEM  
FOR RESECTION IN SALINE SOLUTION

Working element, inner sheath, and telescope rotate in outer sheath



**AUTOCLAVE**  
**134° C / 273° F**

**CI** Double sheath system

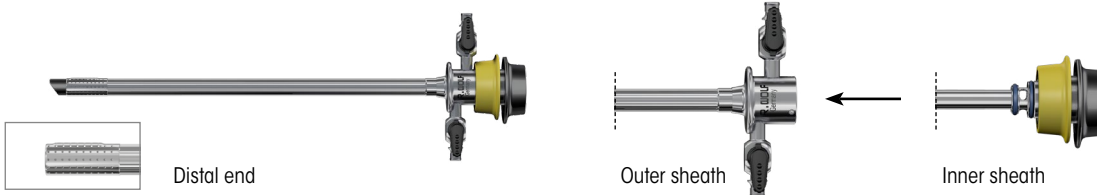

for sheath sizes		SL/WL	Color coding	Product no.
<b>CI</b> 22/24 Fr	Outer sheath for resectoscope 24 FR	SL 189 mm	Green	<b>8675424</b>
	Inner sheath for resectoscope 22 FR	SL 205 mm		<b>8675322</b>
Also:				
	Obturator for resectoscope 22 FR	WL 232 mm	Green	<b>8673022</b>
	Viewing obturator for resectoscope 22 FR			<b>8673122</b>
<b>CI</b> 24/26 Fr	Outer sheath for resectoscope 26 FR	SL 189 mm	Yellow	<b>8675426</b>
	Inner sheath for resectoscope 24 FR	SL 205 mm		<b>8675324</b>
Also:				
	Obturator for resectoscope 24 FR	WL 233 mm	Yellow	<b>8673024</b>
	Viewing obturator for resectoscope 24 FR	WL 232 mm		<b>8673124</b>
	Dilatations obturator f. resectoscope 24 FR	WL 247 mm		<b>8673224</b>

Telescopes		see URO45
Working elements		see URO56
Electrodes		see URO65-68
Monopolar connection cable		see URO103/104

"SHARK" RESECTOSCOPES (MONOPOLAR/BIPOLAR)

1.11

IX23 || Subject to modifications. Please note that some products may not be available in all countries. Please always take note of the information that is provided with the product. For more detailed information, please consult with your contact partner or directly with Richard Wolf GmbH.



# MONOPOLAR RESECTOSCOPE

FOR TELESCOPE 4 MM, 0°, 12°, 30°

WITH INTERMITTENT IRRIGATION AND ROTATABLE IRRIGATION ADAPTER

FOR RESECTION IN SALINE SOLUTION



**AUTOCLAVE**  
**134° C / 273° F**

**II Sheath with rotatable irrigation adapter**

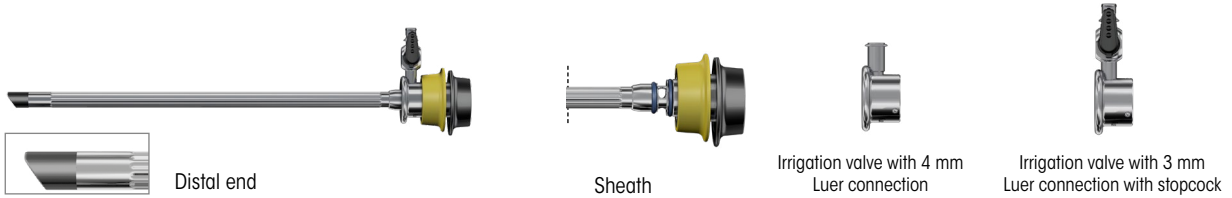

for sheath sizes		SL/WL	Color coding	Product no.
 <b>24 Fr</b>	Sheath for resectoscope 24 FR	SL 200 mm	Yellow	<b>8676324</b>
	Irrigation adapter for resectoscope 24/26 FR with 4 mm Luer connection			<b>8676354*</b>
	Irrigation adapter for resectoscope 24/26 FR with 3 mm Luer connection with stopcock			<b>8676361**</b>
Also:				
	Obturator for resectoscope 24 FR	WL 233 mm	Yellow	<b>8673024</b>
	Viewing obturator for resectoscope 24 FR	WL 232 mm		<b>8673124</b>
	Dilatations obturator f. resectoscope 24 FR	WL 247 mm		<b>8673224</b>
 <b>26 Fr</b>	Sheath for resectoscope 26 FR	SL 201 mm	Black	<b>8676326</b>
	Irrigation adapter for resectoscope 24/26 FR with 4 mm Luer connection			<b>8676354*</b>
	Irrigation adapter for resectoscope 24/26 FR with 3 mm Luer connection with stopcock			<b>8676361**</b>
Also:				
	Obturator for resectoscope 26 FR	WL 233 mm	Black	<b>8673026</b>
	Viewing obturator for resectoscope 26 FR	WL 232 mm		<b>8673126</b>
	Dilatations obturator f. resectoscope 26 FR	WL 248 mm		<b>8673226</b>
* for connection to rotatable irrigation adapter 8676354: <b>Two-way stopcock, maintenance-free, with LUER-LOCK connection</b>				<b>88351</b>
** for connection to rotatable irrigation adapter 8676361: <b>Two-way stopcock, maintenance-free, with LUER-LOCK connection</b>				<b>88350</b>

<b>Telescopes</b>		see UR045
<b>Working elements</b>		see UR056
<b>Electrodes</b>		see UR065-68
<b>Monopolar connection cable</b>		see UR0103/104

"SHARK" RESECTOSCOPES (MONOPOLAR/BIPOLAR)

1.11



# MONOPOLAR RESECTOSCOPE

FOR TELESCOPE 4 MM, 0°, 12°, 30°  
WITH INTERMITTENT IRRIGATION WITH CENTRAL STOPCOCK  
FOR RESECTION IN SALINE SOLUTION



**II** Sheath with central stopcock

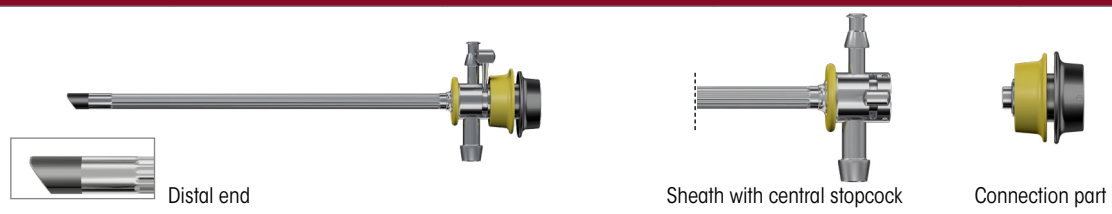

for sheath sizes		SL/WL	Color coding	Product no.
<b>II</b> 24 Fr	Sheath for resectoscope 24 FR	SL 195 mm	Yellow	<b>8676424</b>
	Connection part for resectoscope 24 FR	-		<b>8676342</b>
Also:				
	Obturator for resectoscope 24 FR	WL 233 mm	Yellow	<b>8673024</b>
	Viewing obturator for resectoscope 24 FR	WL 232 mm		<b>8673124</b>
	Dilatations obturator f. resectoscope 24 FR	WL 247 mm		<b>8673224</b>
<b>II</b> 26 Fr	Sheath for resectoscope 26 FR	SL 195 mm	Black	<b>8676426</b>
	Connection part for resectoscope 26 FR	-		<b>8676343</b>
Also:				
	Obturator for resectoscope 26 FR	WL 233 mm	Black	<b>8673026</b>
	Viewing obturator for resectoscope 26 FR	WL 232 mm		<b>8673126</b>
	Dilatations obturator f. resectoscope 26 FR	WL 248 mm		<b>8673226</b>

Telescopes		see UR045
Working elements		see UR056
Electrodes		see UR065-68
Monopolar connection cable		see UR0103/104

"SHARK" RESECTOSCOPES (MONOPOLAR/BIPOLAR)

1.11

IX23 || Subject to modifications. Please note that some products may not be available in all countries. Please always take note of the information that is provided with the product. For more detailed information, please consult with your contact partner or directly with Richard Wolf GmbH.



# BIPOLAR RESECTOSCOPE

FOR TELESCOPE 4 MM, 0°, 12°, 30°  
WITH CONTINUOUS IRRIGATION DOUBLE SHEATH SYSTEM  
FOR RESECTION IN SALINE SOLUTION

Working element, inner sheath, and telescope rotate in outer sheath



**AUTOCLAVE**  
**134° C / 273° F**

**CI** Double sheath system

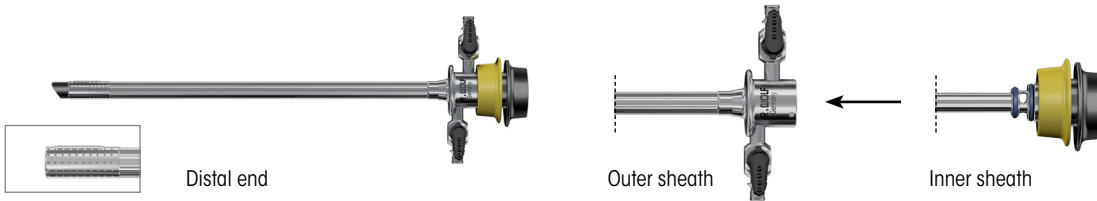

for sheath sizes		SL/WL	Color coding	Product no.
<b>CI</b> 22/24 Fr	Outer sheath for resectoscope 24 FR	SL 189 mm	Green	<b>8675424</b>
	Inner sheath for resectoscope 22 FR	SL 205 mm		<b>8675322</b>
Also:				
	Obturator for resectoscope 22 FR	WL 232 mm	Green	<b>8673022</b>
	Viewing obturator for resectoscope 22 FR			<b>8673122</b>
<b>CI</b> 24/26 Fr	Outer sheath for resectoscope 26 FR	SL 189 mm	Yellow	<b>8675426</b>
	Inner sheath for resectoscope 24 FR	SL 205 mm		<b>8675324</b>
Also:				
	Obturator for resectoscope 24 FR	WL 233 mm	Yellow	<b>8673024</b>
	Viewing obturator for resectoscope 24 FR	WL 232 mm		<b>8673124</b>
	Dilatations obturator f. resectoscope 24 FR	WL 247 mm		<b>8673224</b>

Telescopes		see URO45
Working elements		see URO57
Electrodes		see URO69-71
Bipolar connection cable		see URO105

IX23 || Subject to modifications. Please note that some products may not be available in all countries. Please always take note of the information that is provided with the product. For more detailed information, please consult with your contact partner or directly with Richard Wolf GmbH.



# BIPOLAR RESECTOSCOPE

FOR TELESCOPE 4 MM, 0°, 12°, 30°

WITH INTERMITTENT IRRIGATION AND ROTATABLE IRRIGATION ADAPTER

FOR RESECTION IN SALINE SOLUTION



**II** Sheath with rotatable irrigation adapter

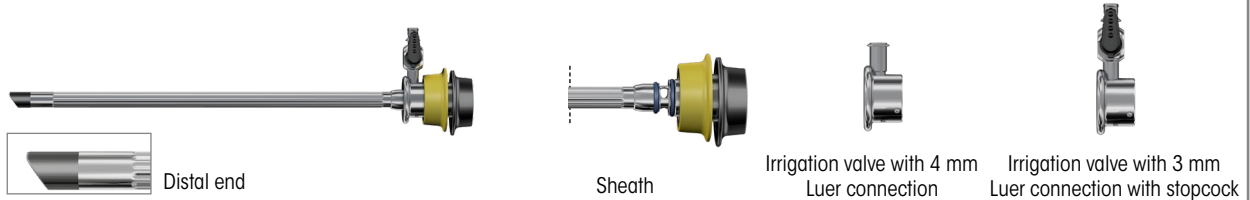

for sheath sizes		SL/WL	Color coding	Product no.
 24 Fr	Sheath for resectoscope 24 FR	SL 200 mm	Yellow	<b>8676324</b>
	Irrigation adapter for resectoscope 24/26 FR with 4 mm Luer connection			<b>8676354*</b>
	Irrigation adapter for resectoscope 24/26 FR with 3 mm Luer connection with stopcock			<b>8676361**</b>
Also:				
	Obturator for resectoscope 24 FR	WL 233 mm	Yellow	<b>8673024</b>
	Viewing obturator for resectoscope 24 FR	WL 232 mm		<b>8673124</b>
	Dilatations obturator f. resectoscope 24 FR	WL 247 mm		<b>8673224</b>
 26 Fr	Sheath for resectoscope 26 FR	SL 201 mm	Black	<b>8676326</b>
	Irrigation adapter for resectoscope 24/26 FR with 4 mm Luer connection			<b>8676354*</b>
	Irrigation adapter for resectoscope 24/26 FR with 3 mm Luer connection with stopcock			<b>8676361**</b>
Also:				
	Obturator for resectoscope 26 FR	WL 233 mm	Black	<b>8673026</b>
	Viewing obturator for resectoscope 26 FR	WL 232 mm		<b>8673126</b>
	Dilatations obturator f. resectoscope 26 FR	WL 248 mm		<b>8673226</b>
* for connection to rotatable irrigation adapter 8676354: <b>Two-way stopcock, maintenance-free, with LUER-LOCK connection</b>				<b>88351</b>
** for connection to rotatable irrigation adapter 8676361: <b>Two-way stopcock, maintenance-free, with LUER-LOCK connection</b>				<b>88350</b>
Telescopes				see URO45
Working elements				see URO57
Electrodes				see URO69-71
Bipolar connection cable				see URO105

IX23 || Subject to modifications. Please note that some products may not be available in all countries. Please always take note of the information that is provided with the product. For more detailed information, please consult with your contact partner or directly with Richard Wolf GmbH.

"SHARK" RESECTOSCOPES (MONOPOLAR/BIPOLAR)

1.11



# BIPOLAR RESECTOSCOPE

FOR TELESCOPE 4 MM, 0°, 12°, 30°  
WITH INTERMITTENT IRRIGATION WITH CENTRAL STOPCOCK  
FOR RESECTION IN SALINE SOLUTION

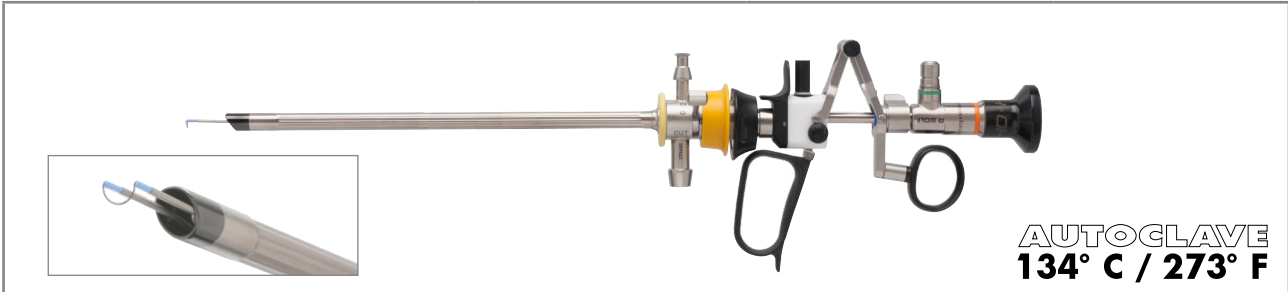

**II Sheath with central stopcock**

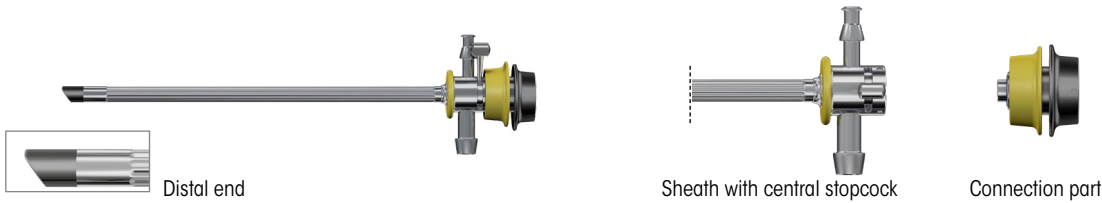

for sheath sizes		SL/WL	Color coding	Product no.
 24 Fr	Sheath for resectoscope 24 FR	SL 195 mm	Yellow	8676424
	Connection part for resectoscope 24 FR	-		8676342

Also:

	Obturator for resectoscope 24 FR	WL 233 mm	Yellow	8673024
	Viewing obturator for resectoscope 24 FR	WL 232 mm		8673124
	Dilatations obturator f. resectoscope 24 FR	WL 247 mm		8673224

**II**  
26 Fr

	Sheath for resectoscope 26 FR	SL 195 mm	Black	8676426
	Connection part for resectoscope 26 FR	-		8676343

Also:

	Obturator for resectoscope 26 FR	WL 233 mm	Black	8673026
	Viewing obturator for resectoscope 26 FR	WL 232 mm		8673126
	Dilatations obturator f. resectoscope 26 FR	WL 248 mm		8673226

Telescopes		see URO45
Working elements		see URO57
Electrodes		see URO69-71
Bipolar connection cable		see URO105

"SHARK" RESECTOSCOPES (MONOPOLAR/BIPOLAR)  
1.11

IX23 || Subject to modifications. Please note that some products may not be available in all countries. Please always take note of the information that is provided with the product. For more detailed information, please consult with your contact partner or directly with Richard Wolf GmbH.



# MONOPOLAR WORKING ELEMENTS

FOR RESECTOSCOPES, MONOPOLAR  
TELESCOPE 4 MM, 0°, 12°, 30°

Direction of view 0°		Handle variants	Cutting	Product no.
<b>Active working element mono 0°</b>  Cut is made against spring pressure		Handle closed	<b>Active</b>	<b>8681205*</b>
<b>Passive working element mono 0°</b>  Cut is made with spring pressure		Handle open	<b>Passive</b>	<b>8681224*</b>

\* Not suitable for 22/24 Fr Double sheath system

Direction of view 12°/30°		Handle variants	Cutting	Product no.
<b>Active working element mono 12/30°</b>  Cut is made against spring pressure		Handle closed	<b>Active</b>	<b>8674205</b>
<b>Active working element mono 12/30°</b>  Cut is made against spring pressure		Handle closed with comfort thumb rest		<b>8674234</b>
<b>Passive working element mono 12/30°</b>  Cut is made with spring pressure		Handle open	<b>Passive</b>	<b>8674224</b>
<b>Passive working element mono 12/30°</b>  Cut is made with spring pressure		Handle closed		<b>8674225</b>

Recommended accessories		Product no.
<b>Rubber cap, red</b> (PU = 5 PCS)	for sealing off the electrode clamping mechanism on the working element	<b>8874</b>
<b>Thumb ring</b>	with relatively large inner diameter	<b>15008.159</b>

"SHARK" RESECTOSCOPES (MONOPOLAR/BIPOLAR)

1.11

IX23 || Subject to modifications. Please note that some products may not be available in all countries. Please always take note of the information that is provided with the product. For more detailed information, please consult with your contact partner or directly with Richard Wolf GmbH.





# BIPOLAR WORKING ELEMENTS

FOR RESECTOSCOPES, BIPOLAR  
TELESCOPE 4 MM, 0°, 12°, 30°

Direction of view 0°/12°/30°		Handle variants	Cutting	Product no.
<b>Active working element</b> bipo 0/12/30°  Cut is made against spring pressure		Handle open	<b>Active</b>	<b>8680.204</b>
<b>Active working element</b> bipo 0/12/30°  Cut is made against spring pressure		Handle closed		<b>8680.205</b>
<b>Passive working element</b> bipo 0/12/30°  Cut is made with spring pressure		Handle open	<b>Passive</b>	<b>8680.224</b>
<b>Passive working element</b> bipo 0/12/30°  Cut is made with spring pressure		Handle closed		<b>8680.225</b>

Recommended accessories		Product no.
<b>Rubber cap, black</b> (PU = 5 PCS)	for sealing off the electrode clamping mechanism on the working element	<b>8880</b>
<b>Thumb ring</b>	with relatively large inner diameter	<b>15008.159</b>

"SHARK" RESECTOSCOPES (MONOPOLAR/BIPOLAR)

1.11

IX23 || Subject to modifications. Please note that some products may not be available in all countries. Please always take note of the information that is provided with the product. For more detailed information, please consult with your contact partner or directly with Richard Wolf GmbH.

E-line

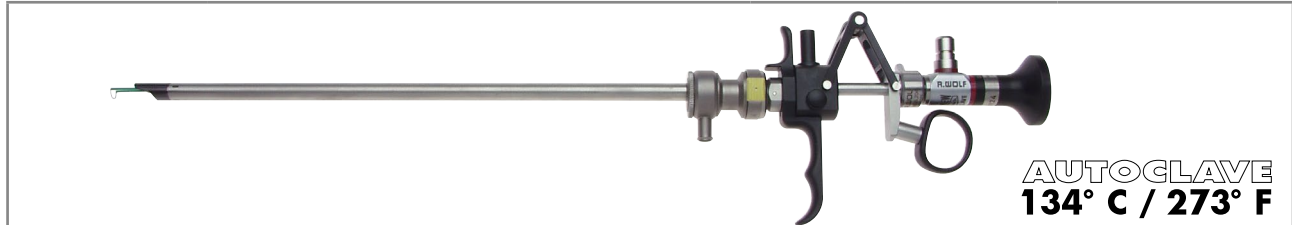

**MONOPOLAR WORKING ELEMENTS**  
FOR RESECTOSCOPE, LONG SHEATH MONOPOLAR TELESCOPE 4 MM, 25°





**II** Sheath with distal ceramic insulation, rotatable irrigation ring

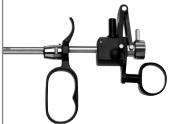

Distal end

for sheath sizes		SL/WL	Color coding	Product no.
 24 Fr	Long sheath for resectoscope 24 FR	SL 257 mm	Yellow	<b>8668.024</b>
<b>Also:</b>				
	Obturator for resectoscope 24 FR	WL 279 mm	Yellow	<b>8668.12</b>
	Cutting electrode mono 24 FR 25°, round loop	-	Branch, green Stem, red	<b>8439.03</b>

Direction of view 25°		Handle variants	Cutting	Product no.
<b>Active working element mono 25°</b> Cut is made against spring pressure		Handle open	<b>Active</b>	<b>8668.204</b>
<b>Passive working element mono 25°</b> Cut is made with spring pressure		Handle closed	<b>Passive</b>	<b>8668.225</b>
<b>Recommended accessories</b>				<b>Product no.</b>
Thumb ring with relatively large inner diameter				<b>15008.159</b>

	Direction of view	Ø	WL	TL	Product no.
Telescope 25° Ø 4 mm WL 342 mm	0°	4.0 mm	342 mm	404 mm	<b>8668.433</b>



<b>Recommended accessories</b>		<b>Product no.</b>
<b>Perforated basket for standard telescope 2</b>	Internal dimensions (W x H x D): 454 x 52 x 40 mm External dimensions (W x H x D): 481 x 54 x 59 mm	<b>38016</b>
<b>Fiber light cable bndl</b> consisting of: Fiber light cable (80662523), projector-side adapter (8095.07), and endoscope-side adapter (809509)	Ø 2.5 mm, 2.3 m long	<b>806625231</b>
<b>Monopolar connection cable</b>		see UR0103/104

"E-LINE" RESECTOSCOPE LONG SHEATH  
1.12

IX23 || Subject to modifications. Please note that some products may not be available in all countries. Please always take note of the information that is provided with the product. For more detailed information, please consult with your contact partner or directly with Richard Wolf GmbH.

# MIDI size

## RESECTOSCOPE

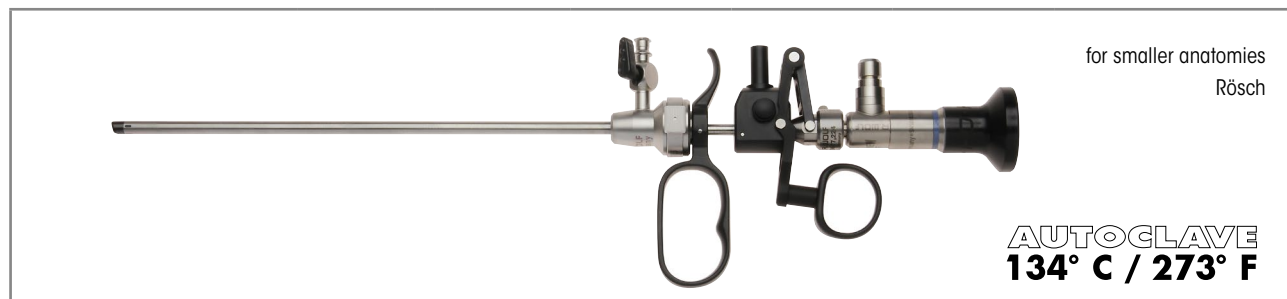

	consisting of:	Product no.
<b>Sheath for resectoscope 14.5 FR</b> with irrigation valve	Sheath for resectoscope 14.5 FR (86770155), obturator for resectoscope 14.5 FR (86770157), tube with LUER-LOCK connector (886.00)	<b>86770151</b>

Also: individual sheaths and obturators



Individual sheath and obturator	SL/WL	Color coding	Product no.	Working element, active, mono 0°
<b>Sheath for resectoscope 14.5 FR</b>	SL 221 mm	White	<b>86770155</b>	<b>8677.224</b>
<b>Obturator for resectoscope 14.5 FR</b>	WL 240 mm	White	<b>86770157</b>	

Also: 

PANOVIEW telescope	Ø	WL	TL	Product no.
<b>Telescope 0° Ø 2.7 mm WL 267 mm</b>	2.7 mm	267 mm	334 mm	<b>8672430</b>



Recommended accessories	Product no.
<b>Perforated basket for standard telescope 2</b>	Internal dimensions (W x H x D): 454 x 52 x 40 mm External dimensions (W x H x D): 481 x 54 x 59 mm <b>38016</b>
<b>Fiber light cable bndl</b> consisting of: Fiber light cable (80662523), projector-side adapter (8095.07), and endoscope-side adapter (809509)	Ø 2.5 mm, 2.3 m long <b>806625231</b>
<b>Container (W x H x D) 300 x 60 x 200 mm</b>	<b>33020</b>
<b>Monopolar connection cable</b>	see UR0103/104



"MIDI-SIZE" RESECTOSCOPE



1.13

IX23 || Subject to modifications. Please note that some products may not be available in all countries. Please always take note of the information that is provided with the product. For more detailed information, please consult with your contact partner or directly with Richard Wolf GmbH.

## MIDI size

### AUXILIARY INSTRUMENTS

Stricture scalpels with ceramic cutter		Cutting surface	Product no.
	<b>Scalpel 14.5 FR, lancet-shaped</b>	Lancet-shaped, cuts on both sides	<b>8677981</b>
	<b>Scalpel 14.5 FR, sickle-shaped</b>	Sickle-shaped	<b>8677931</b>

Electrodes		Electrode shape	Product no.
	<b>Coag. electrode mono 14.5 FR 0°</b> Stem color yellow	Button	<b>8416011</b>
	<b>Cutting electrode mono 14.5 FR 0°</b> Stem color yellow	Round loop	<b>8416031</b>
	<b>Hook electrode mono 14.5 FR 0°</b> Stem color yellow	Hook	<b>8416091</b>

IX23 || Subject to modifications. Please note that some products may not be available in all countries. Please always take note of the information that is provided with the product. For more detailed information, please consult with your contact partner or directly with Richard Wolf GmbH.

# System blue

## SYSTEM COMPONENTS

### FOR PHOTODYNAMIC DIAGNOSTICS (PDD)

ix23 || Subject to modifications. Please note that some products may not be available in all countries. Please always take note of the information that is provided with the product. For more detailed information, please consult with your contact partner or directly with Richard Wolf GmbH.



				Product no.
<b>ENDOLIGHT LED blue bndl</b> consisting of: ENDOLIGHT LED blue (5165001), patch cable, RJ45 SFTP, 0.5 m (72325378), toggle footswitch (2030.105), and power cable 3 m long (2440.03)				<b>51650011</b>
<b>ENDOCAM Logic 4K camera control unit bndl</b> consisting of: ENDOCAM Logic 4K camera control unit (5525301), handheld remote control (5525401), USB flash memory 32 GB (72321829), HDMI/HDMI cable, lockable, 3.0 m (103847), and power cable (2440.03)				<b>55253011</b>
<b>ENDOCAM Logic HD Pendual camera head blue</b> Cable length 3 m				<b>5525833</b>
<b>Also:</b>				
PANOVIEW	Ø	WL	TL	Product no.
Telescope blue 0° Ø 4 mm WL 298 mm	4.0 mm	298 mm	365 mm	<b>8650.514</b>
Telescope blue 12° Ø 4 mm WL 298 mm		298 mm	363 mm	<b>8654.531</b>
Telescope blue 30° Ø 4 mm WL 299 mm		299 mm	364 mm	<b>8654.522</b>
Telescope blue 70° Ø 4 mm WL 303 mm		303 mm	362 mm	<b>8650.515</b>
<b>Special fiber light cable 3.5 mm, 2.3 m set</b> consisting of: Fiber light cable blue Ø 3.5 mm (80673523), endoscope-side adapter (809509)	3.5 mm		2.3 m	<b>806735231</b>

"SYSTEM BLUE" FOR PHOTODYNAMIC DIAGNOSTICS (PDD)

1.14

## System blue

### SYSTEM COMPONENTS FOR PHOTODYNAMIC DIAGNOSTICS (PDD)

#### TUR-B (MONOPOLAR RESECTION OF BLADDER TUMORS)

Transurethral resection of the bladder (TUR-B)		Product no.
<b>Recommendation: TUR-B/monopolar SHARK continuous irrigation resectoscope</b> 22/24 Fr, 30°, for monopolar resection of bladder tumors		
	<b>Working element, active, mono 12/30°</b> Active, closed	<b>8674205</b>
	Optional: <b>working element, passive, mono 12/30°</b> Passive, closed	<b>8674225</b>
	<b>Outer sheath for resectoscope 24 FR</b>	<b>8675424</b>
	<b>Inner sheath for resectoscope 22 FR</b>	<b>8675322</b>
	<b>Obturator for resectoscope 22 FR</b>	<b>8673022</b>
	<b>Viewing obturator for resectoscope 22 FR</b>	<b>8673122</b>
	<b>Special fiber light cable 3.5 mm, 2.3 m SET</b>	<b>806735231</b>
	<b>Telescope blue 30° Ø 4 mm WL 299 mm</b>	<b>8654.522</b>
	Optional: <b>telescope blue 12° Ø 4 mm WL 298 mm</b>	<b>8654.531</b>
	<b>Cutting electrode mono 22 FR 12/30°</b> In individual sterile packaging (PU = 10 PCS)	<b>46782225</b>
<b>Coag. electrode mono 22–24 FR 12/30°</b> In individual sterile packaging (PU = 5 PCS)	<b>46782201</b>	
<b>Recommendation: TUR-B/monopolar SHARK continuous irrigation resectoscope</b> 24/26 Fr, 30°, for monopolar resection of bladder tumors		
	<b>Working element, active, mono 12/30°</b> Active, closed	<b>8674205</b>
	Optional: <b>working element, passive, mono 12/30°</b> Passive, closed	<b>8674225</b>
	<b>Outer sheath for resectoscope 26 FR</b>	<b>8675426</b>
	<b>Inner sheath for resectoscope 24 FR</b>	<b>8675324</b>
	<b>Obturator for resectoscope 24 FR</b>	<b>8673024</b>
	<b>Viewing obturator for resectoscope 24 FR</b>	<b>8673124</b>
	<b>Dilatations obturator f. resectoscope 24 FR</b>	<b>8673224</b>
	<b>Special fiber light cable 3.5 mm, 2.3 m SET</b>	<b>806735231</b>
	<b>Telescope blue 30° Ø 4 mm WL 299 mm</b>	<b>8654.522</b>
	Optional: <b>telescope blue 12° Ø 4 mm WL 298 mm</b>	<b>8654.531</b>
<b>Cutting electrode mono 24 FR 12/30°</b> In individual sterile packaging (PU = 10 PCS)	<b>46782425</b>	

IX23 || Subject to modifications. Please note that some products may not be available in all countries. Please always take note of the information that is provided with the product. For more detailed information, please consult with your contact partner or directly with Richard Wolf GmbH.





"SYSTEM BLUE" FOR PHOTODYNAMIC DIAGNOSTICS (PDD)

1.14

# System blue

## SYSTEM COMPONENTS FOR PHOTODYNAMIC DIAGNOSTICS (PDD)

### TUR-B (BIPOLAR RESECTION OF BLADDER TUMORS)

Transurethral resection of the bladder (TUR-B)		Product no.
<b>Recommendation: TUR-B/bipolar SHARK continuous irrigation resectoscope</b> 22/24 Fr, 30°, for bipolar resection of bladder tumors		
 	<b>Working element, active, bipo 0/12/30°</b> Active, closed	<b>8680.205</b>
	Optional: <b>working element, passive, bipo 0/12/30°</b> Passive, closed	<b>8680.225</b>
	<b>Outer sheath for resectoscope 24 FR</b>	<b>8675424</b>
	<b>Inner sheath for resectoscope 22 FR</b>	<b>8675322</b>
	<b>Obturator for resectoscope 22 FR</b>	<b>8673022</b>
	<b>Viewing obturator for resectoscope 22 FR</b>	<b>8673122</b>
	<b>Special fiber light cable 3.5 mm, 2.3 m SET</b>	<b>806735231</b>
	<b>Telescope blue 30° Ø 4 mm WL 299 mm</b>	<b>8654.522</b>
	Optional: <b>telescope blue 12° Ø 4 mm WL 298 mm</b>	<b>8654.531</b>
	<b>Cutting electrode bipo 22 FR 12/30°</b> In individual sterile packaging (PU = 3 PCS)	<b>4622.2533</b>
	<b>Cutting electrode bipo 22 FR 12/30°</b> In individual sterile packaging (PU = 3 PCS)	<b>4622.1333</b>
	<b>Coag. electrode bipo 22 FR 12/30°</b> In individual sterile packaging (PU = 3 PCS)	<b>4623.0243</b>
<b>Recommendation: TUR-B/bipolar SHARK continuous irrigation resectoscope</b> 24/26 Fr, 30°, for bipolar resection of bladder tumors		
 	<b>Working element, active, bipo 0/12/30°</b> Active, closed	<b>8680.205</b>
	Optional: <b>working element, passive, bipo 0/12/30°</b> Passive, closed	<b>8680.225</b>
	<b>Outer sheath for resectoscope 26 FR</b>	<b>8675426</b>
	<b>Inner sheath for resectoscope 24 FR</b>	<b>8675324</b>
	<b>Obturator for resectoscope 24 FR</b>	<b>8673024</b>
	<b>Viewing obturator for resectoscope 24 FR</b>	<b>8673124</b>
	<b>Special fiber light cable 3.5 mm, 2.3 m SET</b>	<b>806735231</b>
	<b>Telescope blue 30° Ø 4 mm WL 299 mm</b>	<b>8654.522</b>
	Optional: <b>telescope blue 12° Ø 4 mm WL 298 mm</b>	<b>8654.531</b>
	Optional: <b>telescope blue 12° Ø 4 mm WL 298 mm</b>	<b>8654.531</b>
	<b>Cutting electrode bipo 24–26 FR 12/30°</b> In individual sterile packaging (PU = 3 PCS)	<b>4622.2513</b>
	<b>Cutting electrode bipo 24 FR 12/30°</b> In individual sterile packaging (PU = 3 PCS)	<b>4622.1313</b>
	<b>Cutting electrode bipo 24–26 FR 12/30°</b> (oval, specifically for en bloc resection) In individual sterile packaging (PU = 3 PCS)	<b>4622.1323</b>
	<b>Cutting electrode bipo 24–26 FR 12/30°</b> In individual sterile packaging (PU = 3 PCS)	<b>4623.0223</b>



# MONOPOLAR ELECTRODES

FOR MULTIPLE USE

12°/30°

## 12°/30°, for multiple use, monopolar

	Designation	Bracket	for sheath sizes [in Fr]				Color coding		Model
			CI 22/24	II 24	CI 24/26	II 26	Branch	Stem	
	Cutting electrode mono 22 FR 12/30°	Loop Ø 0.35 mm	●	–	–	–	Green	Dark gray	86782235
	Cutting electrode mono 24 FR 12/30°		–	●	●	–	Yellow	Dark gray	86782435
	Cutting electrode mono 26 FR 12/30°		–	–	–	●	Black	Dark gray	86782635
	Cutting electrode mono 24 FR 12/30°	Loop Ø 0.8 mm	–	●	●	–	Yellow	Dark gray	86782480
	Coag. electrode mono 22–24 FR 12/30°	Roller	●	●	●	–	Green	Dark gray	86782201
	Coag. electrode mono 26 FR 12/30°		–	–	–	●	Black	Dark gray	86782601
	Coag. electrode mono 22–24 FR 12/30°	Ball	●	●	●	–	Green	Dark gray	86782202
	Coag. electrode mono 22–24 FR 12/30°	Button	●	●	●	–	Green	Dark gray	86782203
	Coag. electrode mono 26 FR 12/30°		–	–	–	●	Black	Dark gray	86782603
	Knife electrode mono 22–24 FR 12/30°	Knife	●	●	●	–	Green	Dark gray	86782204
	Knife electrode mono 26 FR 12/30°		–	–	–	●	Black	Dark gray	86782604
	Hook electrode mono 22–24 FR 12/30°	Hook	●	●	●	–	Green	Dark gray	86782205
	Hook electrode mono 26 FR 12/30°		–	–	–	●	Black	Dark gray	86782605

● Suitable for corresponding sheath size – Not suitable

CI = continuous irrigation

II = intermittent irrigation

### Recommended accessories

### Product no.

**Protective sterilization sleeve**  
Receptacle for max. 5 electrodes, reusable



**AUTOCLAVE**  
**134° C / 273° F**

**33030**





# MONOPOLAR ELECTRODES

FOR MULTIPLE USE

12°/30°

## 12°/30°, for multiple use, monopolar

	Designation	Bracket	for sheath sizes [in Fr]				Color coding		Model
			CI 22/24	II 24	CI 24/26	II 26	Branch	Stem	
	EVAP-Elektrode mono 24–26 FR 12/30°	Barrel	–	•	•	•	Yellow	Dark gray	86782407
	EVAP-Elektrode mono 24–26 FR 12/30°	Pyramid	–	•	•	•	Yellow	Dark gray	86782408
	Wing electrode mono 22 FR 12/30°	Wing (bracket profile, flat)	•	–	–	–	Green	Dark gray	86782206
	EVAP-Elektrode mono 24 FR 12/30°		–	•	•	–	Yellow	Dark gray	86782406
	EVAP-Elektrode mono 26 FR 12/30°		–	–	–	•	Black	Dark gray	86782606

• Suitable for corresponding sheath size    – Not suitable

**CI** = continuous irrigation

**II** = intermittent irrigation

Recommended accessories	Product no.
<p><b>Protective sterilization sleeve</b> Receptacle for max. 5 electrodes, reusable</p>  <p><b>AUTOCLAVE</b> <b>134° C / 273° F</b></p>	<b>33030</b>



# MONOPOLAR ELECTRODES

FOR MULTIPLE USE

0°

## 0°, for multiple use, monopolar

	Designation	Bracket	for sheath sizes [in Fr]				Color coding		Model
			CI 22/24	II 24	CI 24/26	II 26	Branch	Stem	
	Cutting electrode mono 24 FR 0°	Loop Ø 0.35 mm	-	●	●	-	Yellow	Dark gray	86792435
	Cutting electrode mono 26 FR 0°		-	-	-	●	Black	Dark gray	86792635
	Coag. electrode mono 24 FR 0°	Roller	-	●	●	-	Green	Dark gray	86792201
	Coag. electrode mono 24-26 FR 0°	Ball	-	●	●	●	Transparent	Dark gray	86792202
	EVAP-Elektrode mono 24-26 FR 0°	Barrel	-	●	●	●	Yellow	Dark gray	86792407
	Knife electrode mono 24-26 FR 0°	Knife	-	●	●	●	Transparent	Dark gray	86792204
	Hook electrode mono 24-26 FR 0°	Hook	-	●	●	●	Transparent	Dark gray	86792205

● Suitable for corresponding sheath size    - Not suitable

CI = continuous irrigation

II = intermittent irrigation

"SHARK" ELECTRODES (MONOPOLAR/BIPOLAR) – "E-LINE" ELECTRODES

1.15

Recommended accessories	Product no.
<b>Protective sterilization sleeve</b> Receptacle for max. 5 electrodes, reusable	 <b>AUTOCLAVE</b> <b>134° C / 273° F</b>
	<b>33030</b>

IX23 || Subject to modifications. Please note that some products may not be available in all countries. Please always take note of the information that is provided with the product. For more detailed information, please consult with your contact partner or directly with Richard Wolf GmbH.



# MONOPOLAR ELECTRODES

FOR SINGLE USE  
12°/30°

12°/30°, for single use, sterile\*, monopolar

	Designation (PU = 5 PCS)	Bracket	for sheath sizes [in Fr]				Color coding		Model
			CI 22/24	II 24	CI 24/26	II 26	Branch	Stem	
	Cutting electrode mono 22 FR 12/30°	Loop Ø 0.35 mm	●	–	–	–	Green	Transparent	46782235
	Cutting electrode mono 24 FR 12/30°		–	●	●	–	Yellow	Transparent	46782435
	Cutting electrode mono 26 FR 12/30°		–	–	–	●	Black	Transparent	46782635
	Cutting electrode mono 22 FR 12/30°	Loop Ø 0.25 mm	●	–	–	–	Green	Transparent	46782225
	Cutting electrode mono 24 FR 12/30°		–	●	●	–	Yellow	Transparent	46782425
	Cutting electrode mono 24 FR 12/30°	Loop Ø 0.8 mm	–	●	●	–	Yellow	Transparent	46782480
	Hook electrode mono 24 FR 12/30°	Hook	●	●	●	–	Green	Transparent	46782205
	Hook electrode mono 26 FR 12/30°		–	–	–	●	Black	Transparent	46782605
	Coag. electrode mono 22–24 FR 12/30°	Roller	●	●	●	–	Green	Transparent	46782201
	Coag. electrode mono 22–24 FR 12/30°	Ball	●	●	●	–	Green	Transparent	46782202
	Coag. electrode mono 22–24 FR 12/30°	Button	●	●	●	–	Green	Transparent	46782203
	Coag. electrode mono 26 FR 12/30°		–	–	–	●	Black	Transparent	46782603
	Knife electrode mono 22–24 FR 12/30°	Knife	●	●	●	–	Green	Transparent	46782204
	Knife electrode mono 26 FR 12/30°		–	–	–	●	Black	Transparent	46782604

● Suitable for corresponding sheath size    – Not suitable

\* In individual sterile packaging

CI = continuous irrigation

II = intermittent irrigation

"SHARK" ELECTRODES (MONOPOLAR/BIPOLAR) – "E-LINE" ELECTRODES

1.15

IX23 || Subject to modifications. Please note that some products may not be available in all countries. Please always take note of the information that is provided with the product. For more detailed information, please consult with your contact partner or directly with Richard Wolf GmbH.



# MONOPOLAR ELECTRODES

FOR SINGLE USE

0°

0°, for single use, sterile\*, monopolar

	Designation (PU = 5 PCS)	Bracket	for sheath sizes [in Fr]				Color coding		Model
			CI 22/24	II 24	CI 24/26	II 26	Branch	Stem	
	Cutting electrode mono 24 FR 0°	Loop	-	●	●	-	Yellow	Transparent	46792435
	Cutting electrode mono 26 FR 0°	Ø 0.35 mm	-	-	-	●	Black	Transparent	46792635
	Hook electrode mono 24 FR 0°	Hook	-	●	●	-	Transparent	Transparent	46792205
	Coag. electrode mono 24 FR 0°	Roller	-	●	●	-	Green	Transparent	46792201
	Knife electrode mono 24 FR 0°	Knife	-	●	●	-	Transparent	Transparent	46792204

● Suitable for corresponding sheath size    - Not suitable

\* In individual sterile packaging

CI = continuous irrigation

II = intermittent irrigation



# BIPOLAR ELECTRODES

FOR MULTIPLE USE

0°/12°/30°

## 12°/30°, for multiple use, bipolar

	Designation	Bracket	for sheath sizes [in Fr]				Color coding		Model
			CI 22/24	II 24	CI 24/26	II 26	Branch	Stem	
	Cutting electrode bipo 22 FR 12/30°	Loop Ø 0.3 mm	•	–	–	–	Blue	Yellow	8622133
	Cutting electrode bipo 24 FR 12/30°		–	•	•	•	Blue	Yellow	8622131
	Coag. electrode bipo 22–26 FR 12/30°	Cylinder Ø 1.2 mm	•	•	•	•	Blue	Yellow	8623022
	Hook electrode bipo 22–26 FR 12/30°	Hook	•	•	•	•	Blue	Yellow	862309

## 0°, for multiple use, bipolar

	Designation	Bracket	for sheath sizes [in Fr]				Color coding		Model
			CI 22/24	II 24	CI 24/26	II 26	Branch	Stem	
	Cutting electrode bipo 24 FR 0°	Loop Ø 0.3 mm	–	•	•	–	Blue	Yellow	8609031

• Suitable for corresponding sheath size    – Not suitable

**CI** = continuous irrigation

**II** = intermittent irrigation

Recommended accessories	Product no.
<b>Protective sterilization sleeve</b> Receptacle for max. 5 electrodes, reusable  <b>AUTOCLAVE</b> <b>134° C / 273° F</b>	<b>33030</b>



# BIPOLAR ELECTRODES

FOR SINGLE USE

12°/30°

**12°/30°, for single use, sterile\*, bipolar**

	Designation (PU = 3 PCS)	Bracket	for sheath sizes [in Fr]				Color coding		Model
			CI 22/24	II 24	CI 24/26	II 26	Branch	Stem	
	Cutting electrode bipo 22 FR 12/30°	Loop Ø 0.3 mm	●	–	–	–	Blue	Blue	4622.1333
	Cutting electrode bipo 24 FR 12/30°		–	●	●	–	Blue	Blue	4622.1313
	Cutting electrode bipo 26 FR 12/30°		–	–	●	●	Green	Blue	4624.1313
	Cutting electrode bipo 22 FR 12/30°	Loop Ø 0.25 mm	●	–	–	–	Blue	Blue	4622.2533
	Cutting electrode bipo 24–26 FR 12/30°		–	●	●	●	Blue	Blue	4622.2513
	Cutting electrode bipo 24–26 FR 12/30° Oval, specifically for en bloc resection	Loop Ø 0.3 mm	–	●	●	●	Blue	Blue	4622.1323
	Coag. electrode bipo 22 FR 12/30°	Cylinder Ø 1.2 mm	●	–	–	–	Blue	Blue	4623.0243
	Coag. electrode bipo 24–26 FR 12/30°		–	●	●	●	Blue	Blue	4623.0223
	BiVAP-Elektrode bipo 22 FR 12/30°	Torus	●	–	–	–	Blue	Blue	46300223
	BiVAP-Elektrode bipo 24–26 FR 12/30°		–	●	●	●	Blue	Blue	46300243
	Enucleation electrode bipo 22 FR 12/30°	Torus	●	–	–	–	Blue	Blue	46400223
	Enucleation electrode bipo 24 FR 12/30°		–	●	●	●	Blue	Blue	46300243

● Suitable for corresponding sheath size    – Not suitable

\* In individual sterile packaging

CI = continuous irrigation

II = intermittent irrigation

IX23 || Subject to modifications. Please note that some products may not be available in all countries. Please always take note of the information that is provided with the product. For more detailed information, please consult with your contact partner or directly with Richard Wolf GmbH.



# BIPOLAR ELECTRODES

FOR SINGLE USE

0°

0°, for single use, sterile\*, bipolar

	Designation (PU = 3 PCS)	Bracket	for sheath sizes [in Fr]				Color coding		Model
			CI 22/24	II 24	CI 24/26	II 26	Branch	Stem	
	Cutting electrode bipo 24 FR 0°	Loop	-	•	•	-	Blue	Blue	4609.0313
	Cutting electrode bipo 26 FR 0°	Ø 0.3 mm	-	-	-	•	Green	Blue	4611.0313
	Cutting electrode bipo 24 FR 0°	Loop Ø 0.25 mm	-	•	•	-	Blue	Blue	4609.2513
	Cutting electrode bipo 24-26 FR 0°	Loop Ø 0.3 mm	-	•	•	•	Blue	Blue	4609.0323
	Coag. electrode bipo 24-26 FR 0°	Cylinder Ø 1.2 mm	-	•	•	•	Blue	Blue	4610.0223
	BiVAP-Elektrode bipo 24-26 FR 0°	Torus	-	•	•	•	Blue	Blue	46310243

• Suitable for corresponding sheath size    - Not suitable

\* In individual sterile packaging

CI = continuous irrigation



II = intermittent irrigation

*E-line*

**MONOPOLAR ELECTRODES**

FOR RESECTOSCOPES, TELESCOPE 4 MM,  
25°, LONG SHEATH

**25°, for multiple use, monopolar**

	Designation	Bracket	 24	Color coding		Model
				Branch	Stem	
	Cutting electrode mono 24 FR 25°	Loop Ø 0.3 mm	•	Green	Red	8439.03
	Coag. electrode mono 24 FR 25°	Roller	•	Blue	Red	8440.02

"SHARK" ELECTRODES (MONOPOLAR/BIPOLAR) – "E-LINE" ELECTRODES

1.15

Recommended accessories	Product no.
<p><b>Protective sterilization sleeve</b> Receptacle for max. 5 electrodes, reusable</p>  <p><b>AUTOCLAVE</b> <b>134° C / 273° F</b></p>	<b>33030</b>













IX23 || Subject to modifications. Please note that some products may not be available in all countries. Please always take note of the information that is provided with the product. For more detailed information, please consult with your contact partner or directly with Richard Wolf GmbH.



# ACCESSORIES

## FOR RESECTOSCOPE SHEATHS



for sheath sizes [in Fr]		Via	Working units of cysto-urethroscope 8650 for use in resectoscope sheaths		with telescope Ø 4 mm	
 24/26 Fr	 26 Fr		Version	Product no.		
•	•	Only for diagnostics	 Adapter with instrument port	<b>8652.264</b>	0°, 12°, 30°, 70°	
•	•	Adapter for E-Line sheaths 8652  <b>8652.704</b>	 Opt. scissors, "Wuppertal" model	<b>8650.644</b>	0°	
-	•		 Opt. biopsy forceps, "Marburg" model	<b>8650.614</b>	0°	
-	•		 Opt. grasping forceps, curved downward	<b>8650.654</b>	0°	
-	•		 Opt. biopsy forceps, spoon downward	<b>8650.774</b>	0°	
-	•		 Opt. grasping forceps, straight	<b>8650.684</b>	0°	
-	•		 Opt. biopsy forceps, spoon-shaped	<b>8650.604</b>	0°	
-	•		 Opt. coag. biopsy forceps, Tauber	<b>8650.624</b>	0°	
-	•		without adapter	 Working insert for cystoscope 0/30/70* or working insert for cystoscope 30/70**	<b>8650.204*</b> or <b>8650.214**</b>	(0°, 12°) 30°, 70°

 = intermittent irrigation

 = continuous irrigation



"SHARK" ELECTRODES (MONOPOLAR/BIPOLAR) – "E-LINE" ELECTRODES

1.15

IX23 || Subject to modifications. Please note that some products may not be available in all countries. Please always take note of the information that is provided with the product. For more detailed information, please consult with your contact partner or directly with Richard Wolf GmbH.

# ACCESSORIES





FOR RESECTOSCOPE SHEATHS   
WITH 4 MM TELESCOPE

		Ø	for sheaths	
			with rotatable and replaceable irrigation ring Capacity 4 mm	with fixed Luer stopcock Capacity 3 mm
	Two-way stopcock, maintenance-free with LUER-LOCK connection, reusable	3 mm		<b>88350</b>
		4 mm	<b>88351</b>	
	Stopcock LUER-LOCK connection Ø 3 mm	3 mm		<b>884.00</b>
	Stopcock LUER-LOCK connection Ø 4 mm	4 mm	<b>884.01</b>	
	Tube with LUER-LOCK connector	3 mm		<b>886.00</b>

IX23 || Subject to modifications. Please note that some products may not be available in all countries. Please always take note of the information that is provided with the product. For more detailed information, please consult with your contact partner or directly with Richard Wolf GmbH.

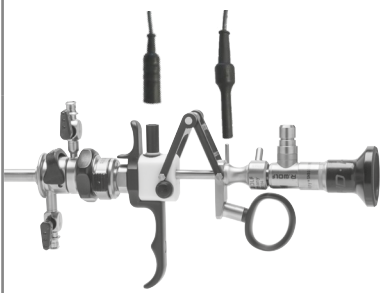
# ACCESSORIES

## HF CONNECTION CABLE BIPO FOR RESECTION IN SALINE SOLUTION

Instrument connector	Device connector		Product no.
 <p><b>WOLF S(a)line resectoscopes</b></p>	 <p>Erbe VIO 300D</p>	<p><b>Bipolar cable; TUR/TCR; WOLF</b></p> <p>MF plug; L 4 m</p>	<b>20196-119</b>
	 <p>Erbe VIO 3</p>	<p><b>BIPOLAR CABLE; MF-U</b></p> <p>MF plug; L 4.5 m</p>	<b>21196-119</b>
	 <p>KLS Martin</p>	<p><b>HF connection cable bipo; L 3 m</b></p>	<b>8108.231</b>
		<p><b>HF connection cable bipo; L 5 m</b></p>	<b>8108.251</b>
	 <p>R. Wolf HF surgical generator 400 kHz 2260001/2260002</p>	<p><b>HF connection cable bipo; L 3 m</b></p>	<b>8108233</b>
		<p><b>HF connection cable bipo; L 5 m</b></p>	<b>8108253</b>

# GREENLIGHT™ CONTINUOUS IRRIGATION LASER CYSTOSCOPE "MoXy™" PARTICULARLY FOR THE USE OF MOXY™ LASER FIBERS



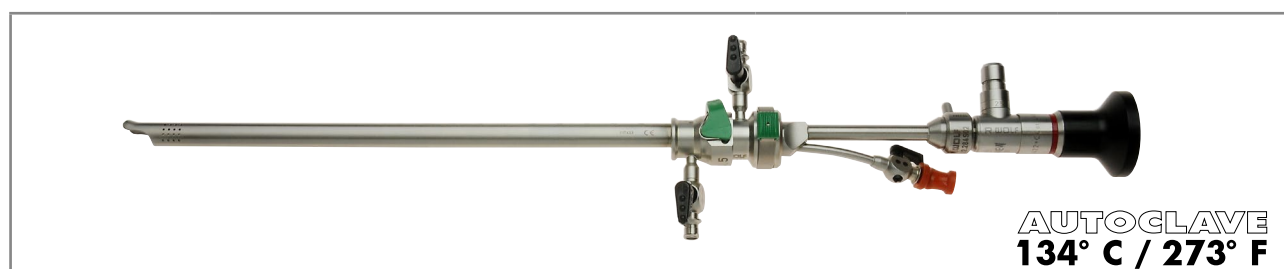

LASER ENUCLEATION

1.17



**CI** Double sheath system



for sheath sizes		SL/WL	Color coding	Product no.	
<b>CI</b> 24.4 Fr	Outer sheath for laser therapy 24.5 FR	SL 205 mm	Green	<b>8632028</b>	
	Inner sheath for laser therapy	SL 217 mm		<b>8632029</b>	
<b>Also:</b>					
	Obturator for laser therapy 24.5 FR	WL 220 mm	Green	<b>8632128</b>	
	Viewing obturator for laser therapy 24.5 FR	WL 219 mm		<b>8632728</b>	
Working insert for freely controlling the laser fiber without a stop. Stabilizes the fiber tip incredibly well during GreenLight vaporization, for example				Product no.	
<b>Laser working insert 12/30</b> "MoXy™" for flexible auxiliary instruments up to 6.5 Fr				<b>8632.284</b>	
<b>Rubber cap for hysteroscope</b> Extended, red-orange (1 PC)				<b>18.01</b>	
<b>Also:</b> 					
PANOVIEW	Direction of view	Ø	WL	TL	Product no.
Telescope 30° Ø 4 mm WL 300 mm	30°	4.0 mm	300 mm	364 mm	<b>8654.422</b>
Telescope 12° Ø 4 mm WL 297 mm	12°	4.0 mm	297 mm	363 mm	<b>8654.431</b>
<b>Recommended accessories</b>					Product no.
<b>Perforated basket for standard telescope 2</b>		Internal dimensions (W x H x D): 454 x 52 x 40 mm External dimensions (W x H x D): 481 x 54 x 59 mm			<b>38016</b>
<b>Fiber light cable bndl</b> consisting of: Fiber light cable (80662523), projector-side adapter (8095.07), and endoscope-side adapter (809509)		Ø 2.5 mm, 2.3 m long			<b>806625231</b>

IX23 || Subject to modifications. Please note that some products may not be available in all countries. Please always take note of the information that is provided with the product. For more detailed information, please consult with your contact partner or directly with Richard Wolf GmbH.



# GREENLIGHT™ CONTINUOUS IRRIGATION LASER RESECTOSCOPE "MoXy™"

PARTICULARLY FOR THE USE OF MOXY™ LASER FIBERS



**CI Double sheath system**

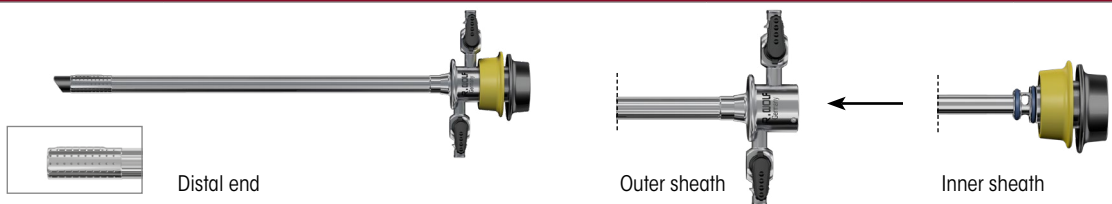

for sheath sizes		SL/WL	Color coding	Product no.
<b>CI</b> 24 Fr	Outer sheath for resectoscope 24 FR	SL 189 mm	Green	<b>8675424</b>
	Inner sheath for resectoscope 22 FR	SL 205 mm		<b>8675322</b>

**Also:**

	Obturator for resectoscope 22 FR	WL 232 mm	Green	<b>8673022</b>
	Viewing obturator for resectoscope 22 FR			<b>8673122</b>
<b>CI</b> 26 Fr	Outer sheath for resectoscope 26 FR	SL 189 mm	Yellow	<b>8675426</b>
	Inner sheath for resectoscope 24 FR	SL 205 mm		<b>8675324</b>

**Also:**

	Obturator for resectoscope 24 FR	WL 233 mm	Yellow	<b>8673024</b>
	Viewing obturator for resectoscope 24 FR	WL 232 mm		<b>8673124</b>
	Dilatations obturator f. resectoscope 24 FR	WL 247 mm		<b>8673224</b>

Working insert for freely controlling the laser fiber without a stop. Stabilizes the fiber tip incredibly well during GreenLight vaporization, for example		Product no.
<b>Laser working insert 12/30</b> "MoXy™" for flexible auxiliary instruments up to 6.5 Fr		<b>8632.284</b>
<b>Rubber cap for hysteroscope, extended, red-orange (1 PC)</b>		<b>18.01</b>

**Also:**

PANOVIEW	Direction of view	Ø	WL	TL	Product no.
Telescope 30° Ø 4 mm WL 300 mm	30°	4.0 mm	300 mm	364 mm	<b>8654.422</b>
Telescope 12° Ø 4 mm WL 297 mm	12°	4.0 mm	297 mm	363 mm	<b>8654.431</b>

**Recommended accessories**

		Product no.
<b>Perforated basket for standard telescope 2</b>	Internal dimensions (W x H x D): 454 x 52 x 40 mm External dimensions (W x H x D): 481 x 54 x 59 mm	<b>38016</b>
<b>Fiber light cable bndl</b> consisting of: Fiber light cable (80662523), projector-side adapter (8095.07), and endoscope-side adapter (809509)	Ø 2.5 mm, 2.3 m long	<b>806625231</b>

ix23 || Subject to modifications. Please note that some products may not be available in all countries. Please always take note of the information that is provided with the product. For more detailed information, please consult with your contact partner or directly with Richard Wolf GmbH.



# CONTINUOUS IRRIGATION LASER ENUCLEATION SHEATH 26 FR "MoXy™"

FOR **BLUNT** ENUCLEATION OF THE PROSTATE



**CI** Double sheath system

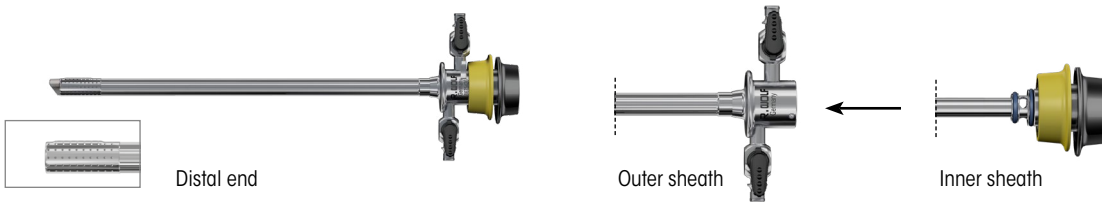

for sheath sizes		SL/WL	Color coding	Product no.
	Outer sheath for resectoscope 26 FR	SL 189 mm	Yellow	<b>8675426</b>
	Inner sheath for laser therapy 24 FR	SL 203 mm		<b>8675524</b>

**Also:**

	Obturator for resectoscope 24 FR	WL 232 mm	Yellow	<b>8673324</b>
--	----------------------------------	-----------	--------	----------------

Working insert for freely controlling the laser fiber without a stop. Stabilizes the fiber tip incredibly well during GreenLight vaporization, for example

**Product no.**

<b>Laser working insert 12/30</b> "MoXy™" for flexible auxiliary instruments up to 6.5 Fr		<b>8632.284</b>
--	--	-----------------

<b>Rubber cap for hysteroscope, extended, red-orange (1 PC)</b>		<b>18.01</b>
---	--	--------------

**Also:**

PANOVIEW	Direction of view	Ø	WL	TL	Product no.
Telescope 30° Ø 4 mm WL 300 mm	30°	4.0 mm	300 mm	364 mm	<b>8654.422</b>
Telescope 12° Ø 4 mm WL 297 mm	12°	4.0 mm	297 mm	363 mm	<b>8654.431</b>

**Recommended accessories** **Product no.**

<b>Perforated basket for standard telescope 2</b>	Internal dimensions (W x H x D): 454 x 52 x 40 mm External dimensions (W x H x D): 481 x 54 x 59 mm	<b>38016</b>
<b>Fiber light cable bndl</b> consisting of: Fiber light cable (80662523), projector-side adapter (8095.07), and endoscope-side adapter (809509)	Ø 2.5 mm, 2.3 m long	<b>806625231</b>

IX23 || Subject to modifications. Please note that some products may not be available in all countries. Please always take note of the information that is provided with the product. For more detailed information, please consult with your contact partner or directly with Richard Wolf GmbH.

# GREENLIGHT™ CONTINUOUS IRRIGATION LASER CYSTOSCOPE "Freestyle"

PARTICULARLY FOR THE USE OF GREENLIGHT™ AND SIMILAR LASER FIBERS



**CI** Double sheath system

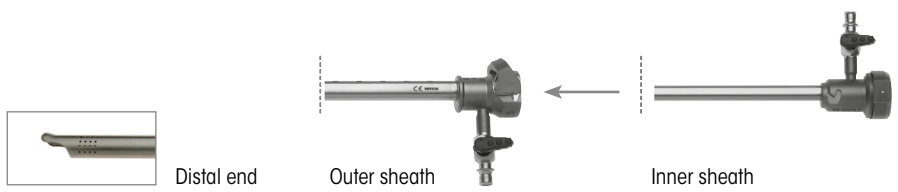

for sheath sizes		SL/WL	Color coding	Product no.
<b>CI</b> 22.5 Fr	Outer sheath for laser therapy 22.5 FR	SL 196 mm	Green	<b>8632.026</b>
	Inner sheath for laser therapy	SL 209 mm		<b>8632.027</b>

Also:

	Obturator for laser therapy 22.5 FR	WL 214 mm	Green	<b>8632.126</b>
	Viewing obturator for laser therapy 22.5 FR			<b>8632.726</b>

<b>CI</b> 24.5 Fr	Outer sheath for laser therapy 24.5 FR	SL 205 mm	Green	<b>8632028</b>
	Inner sheath for laser therapy	SL 217 mm		<b>8632029</b>

Also:

	Obturator for laser therapy 24.5 FR	WL 220 mm	Green	<b>8632128</b>
	Viewing obturator for laser therapy 24.5 FR	WL 219 mm		<b>8632728</b>

Working insert for freely controlling the laser fiber without a stop.

Product no.

<b>Laser working insert 12/30</b> "Freestyle" for flexible auxiliary instruments up to 6.5 Fr		<b>8632.914</b>
--	--	-----------------

Also: 

PANOVIEW	Direction of view	Ø	WL	TL	Product no.
Telescope 30° Ø 4 mm WL 300 mm	30°	4.0 mm	300 mm	364 mm	<b>8654.422</b>
Telescope 12° Ø 4 mm WL 297 mm	12°	4.0 mm	297 mm	363 mm	<b>8654.431</b>

**Recommended accessories** Product no.

<b>Perforated basket for standard telescope 2</b>	Internal dimensions (W x H x D): 454 x 52 x 40 mm External dimensions (W x H x D): 481 x 54 x 59 mm	<b>38016</b>
<b>Fiber light cable bndl</b> consisting of: Fiber light cable (80662523), projector-side adapter (8095.07), and endoscope-side adapter (809509)	Ø 2.5 mm, 2.3 m long	<b>806625231</b>

IX23 || Subject to modifications. Please note that some products may not be available in all countries. Please always take note of the information that is provided with the product. For more detailed information, please consult with your contact partner or directly with Richard Wolf GmbH.



# GREENLIGHT™ CONTINUOUS IRRIGATION LASER RESECTOSCOPE "Freestyle"

PARTICULARLY FOR THE USE OF GREENLIGHT™ AND SIMILAR LASER FIBERS



spirit of excellence

LASER ENUCLEATION

1.17



**CI Double sheath system**

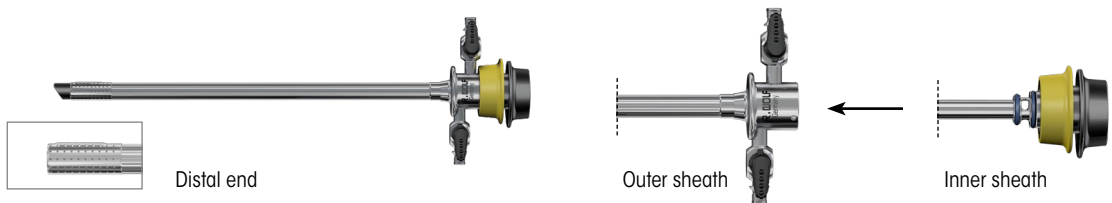

for sheath sizes		SL/WL	Color coding	Product no.
<b>CI</b> 24 Fr	Outer sheath for resectoscope 24 FR	SL 189 mm	Green	<b>8675424</b>
	Inner sheath for resectoscope 22 FR	SL 205 mm		<b>8675322</b>

**Also:**

	Obturator for resectoscope 22 FR	WL 232 mm	Green	<b>8673022</b>
	Viewing obturator for resectoscope 22 FR			<b>8673122</b>
<b>CI</b> 26 Fr	Outer sheath for resectoscope 26 FR	SL 189 mm	Yellow	<b>8675426</b>
	Inner sheath for resectoscope 24 FR	SL 205 mm		<b>8675324</b>

**Also:**

	Obturator for resectoscope 24 FR	WL 233 mm	Yellow	<b>8673024</b>
	Viewing obturator for resectoscope 24 FR	WL 232 mm		<b>8673124</b>
	Dilatations obturator f. resectoscope 24 FR	WL 247 mm		<b>8673224</b>

**Working insert for freely controlling the laser fiber without a stop.**

	Product no.
<b>Laser working insert 12/30</b> "Freestyle" for flexible auxiliary instruments up to 6.5 Fr	<b>8632.914</b>

**Also:**

PANOVIEW	Direction of view	Ø	WL	TL	Product no.
Telescope 30° Ø 4 mm WL 300 mm	30°	4.0 mm	300 mm	364 mm	<b>8654.422</b>
Telescope 12° Ø 4 mm WL 297 mm	12°	4.0 mm	297 mm	363 mm	<b>8654.431</b>

**Recommended accessories**

	Product no.
<b>Perforated basket for standard telescope 2</b> Internal dimensions (W x H x D): 454 x 52 x 40 mm External dimensions (W x H x D): 481 x 54 x 59 mm	<b>38016</b>
<b>Fiber light cable bndl</b> consisting of: Fiber light cable (80662523), projector-side adapter (8095.07), and endoscope-side adapter (809509)	<b>806625231</b>

IX23 || Subject to modifications. Please note that some products may not be available in all countries. Please always take note of the information that is provided with the product. For more detailed information, please consult with your contact partner or directly with Richard Wolf GmbH.





# CONTINUOUS IRRIGATION LASER ENUCLEATION SHEATH 26 FR "Freestyle"

FOR **BLUNT** ENUCLEATION OF THE PROSTATE



**CI** Double sheath system

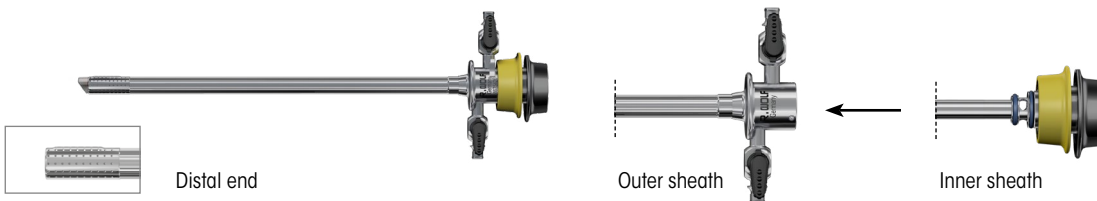

for sheath sizes		SL/WL	Color coding	Product no.
<b>CI</b> 26 Fr	Outer sheath for resectoscope 26 FR	SL 189 mm	Yellow	<b>8675426</b>
	Inner sheath for laser therapy 24 FR	SL 206 mm		<b>8675524</b>

**Also:**

	<b>Obturator for resectoscope 24 FR</b>	WL 232 mm	Yellow	<b>8673324</b>
--	---	-----------	--------	----------------

Working insert for freely controlling the laser fiber without a stop.

Product no.

**Laser working insert 12/30**

"Freestyle" for flexible auxiliary instruments up to 6.5 Fr



**8632.914**

**Also:**



PANOVIEW	Direction of view	Ø	WL	TL	Product no.
Telescope 30° Ø 4 mm WL 300 mm	30°	4.0 mm	300 mm	364 mm	<b>8654.422</b>
Telescope 12° Ø 4 mm WL 297 mm	12°	4.0 mm	297 mm	363 mm	<b>8654.431</b>

**Recommended accessories**

Product no.

**Perforated basket for standard telescope 2**

Internal dimensions (W x H x D): 454 x 52 x 40 mm  
External dimensions (W x H x D): 481 x 54 x 59 mm

**38016**

**Fiber light cable bndl consisting of:**

Fiber light cable (80662523), projector-side adapter (8095.07), and endoscope-side adapter (809509)

Ø 2.5 mm, 2.3 m long

**806625231**



# CONTINUOUS IRRIGATION WORKING INSERT FOR LASER PROBES UP TO 7.5 FR



**AUTOCLAVE**  
**134° C / 273° F**

**II Sheath with rotatable irrigation adapter**

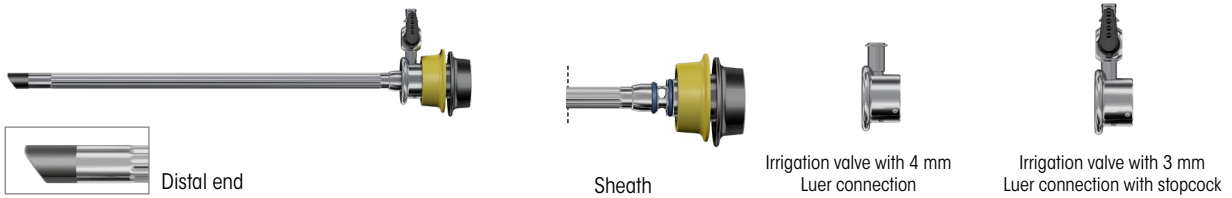

for sheath sizes		SL/WL	Color coding	Product no.
24 Fr	Sheath for resectoscope 24 FR	SL 200 mm	Yellow	<b>8676324</b>
	Irrigation adapter for resectoscope 24/26 FR with 4 mm Luer connection			<b>8676354*</b>
	Irrigation adapter for resectoscope 24/26 FR with 3 mm Luer connection with stopcock			<b>8676361**</b>

**Also:**

	Obturator for resectoscope 24 FR	WL 233 mm	Yellow	<b>8673024</b>
	Viewing obturator for resectoscope 24 FR	WL 232 mm		<b>8673124</b>
	Dilatations obturator f. resectoscope 24 FR	WL 247 mm		<b>8673224</b>

\* for connection to rotatable irrigation adapter 8676354: **Two-way stopcock, maintenance-free,** with LUER-LOCK connection **88351**

\*\* for connection to rotatable irrigation adapter 8676361: **Two-way stopcock, maintenance-free,** with LUER-LOCK connection **88350**

**Working insert for continuous irrigation with instrument port for flexible auxiliary instruments up to 7.5 Fr** **Product no.**

Laser working insert 12/30 7.5 FR		<b>8654.911</b>
-----------------------------------	--	-----------------

**Also:**

PANOVIEW	Direction of view	Ø	WL	TL	Product no.
Telescope 30° Ø 4 mm WL 300 mm	30°	4.0 mm	300 mm	364 mm	<b>8654.422</b>
Telescope 12° Ø 4 mm WL 297 mm	12°	4.0 mm	297 mm	363 mm	<b>8654.431</b>

**Recommended accessories** **Product no.**

Perforated basket for standard telescope 2	Internal dimensions (W x H x D): 454 x 52 x 40 mm External dimensions (W x H x D): 481 x 54 x 59 mm	<b>38016</b>
Fiber light cable bndl consisting of: Fiber light cable (80662523), projector-side adapter (8095.07), and endoscope-side adapter (809509)	Ø 2.5 mm, 2.3 m long	<b>806625231</b>

IX23 || Subject to modifications. Please note that some products may not be available in all countries. Please always take note of the information that is provided with the product. For more detailed information, please consult with your contact partner or directly with Richard Wolf GmbH.



HOLEP, THULEP

# CONTINUOUS IRRIGATION LASER ENUCLEATION SHEATH 26 FR

FOR **BLUNT** ENUCLEATION OF THE PROSTATE



**AUTOCLAVE**  
134° C / 273° F

**CI** Double sheath system

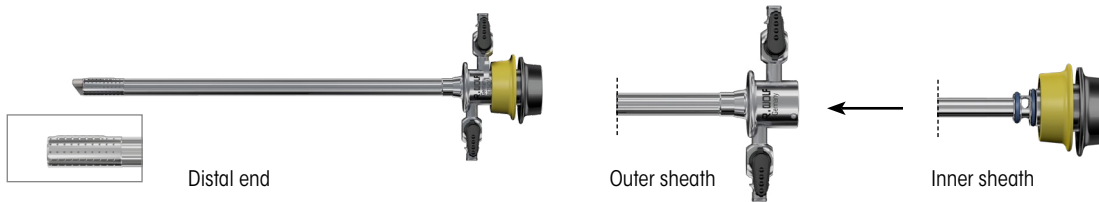

for sheath sizes		SL/WL	Color coding	Product no.
	Outer sheath for resectoscope 26 FR	SL 189 mm	Yellow	<b>8675426</b>
	Inner sheath for laser therapy 24 FR	SL 206 mm		<b>8675524</b>

Also:

	Obturator for resectoscope 24 FR	WL 232 mm	Yellow	<b>8673324</b>
--	----------------------------------	-----------	--------	----------------

**Working element**

	Product no.
Laser working element, passive 12/30° with handle closed	<b>8654382</b>
Laser working insert 12/30°	<b>8654383</b>

Guide tubes



see UR084

Also:



PANOVIEW	Direction of view	Ø	WL	TL	Product no.
Telescope 30° Ø 4 mm WL 300 mm	30°	4.0 mm	300 mm	364 mm	<b>8654.422</b>
Telescope 12° Ø 4 mm WL 297 mm	12°	4.0 mm	297 mm	363 mm	<b>8654.431</b>

**Recommended accessories**

Product no.

<b>Perforated basket for standard telescope 2</b>	Internal dimensions (W x H x D): 454 x 52 x 40 mm External dimensions (W x H x D): 481 x 54 x 59 mm	<b>38016</b>
<b>Fiber light cable bndl</b> consisting of: Fiber light cable (80662523), projector-side adapter (8095.07), and endoscope-side adapter (809509)	Ø 2.5 mm, 2.3 m long	<b>806625231</b>



HOLEP, THULEP

CONTINUOUS IRRIGATION LASER ENUCLEATION SHEATH, 26 FR

FOR ENUCLEATION OF THE PROSTATE



spirit of excellence

LASER ENUCLEATION

1.17

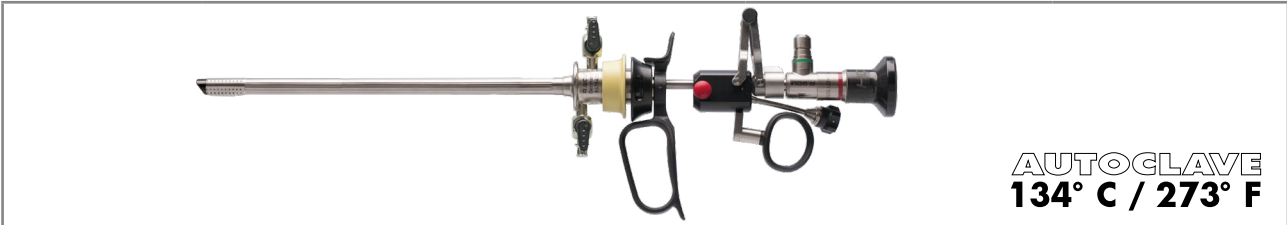

**AUTOCLAVE**  
**134° C / 273° F**

**CI** Double sheath system

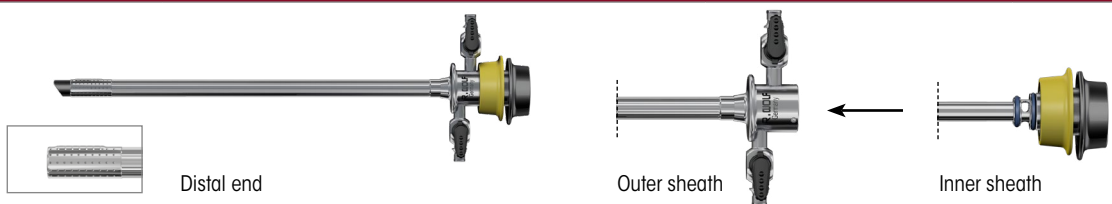





for sheath sizes		SL/WL	Color coding	Product no.	
<b>CI</b> 24 Fr	Outer sheath for resectoscope 24 FR	SL 189 mm	Green	<b>8675424</b>	
	Inner sheath for resectoscope 22 FR	SL 205 mm		<b>8675322</b>	
<b>Also:</b>					
	Obturator for resectoscope 22 FR	WL 232 mm	Green	<b>8673022</b>	
	Viewing obturator for resectoscope 22 FR			<b>8673122</b>	
<b>CI</b> 26 Fr	Outer sheath for resectoscope 26 FR	SL 189 mm	Yellow	<b>8675426</b>	
	Inner sheath for resectoscope 24 FR	SL 205 mm		<b>8675324</b>	
<b>Also:</b>					
	Obturator for resectoscope 24 FR	WL 233 mm	Yellow	<b>8673024</b>	
	Viewing obturator for resectoscope 24 FR	WL 232 mm		<b>8673124</b>	
	Dilatations obturator f. resectoscope 24 FR	WL 247 mm		<b>8673224</b>	
<b>Working element</b>				<b>Product no.</b>	
Laser working element, passive 12/30° with handle closed			<b>8654382</b>		
Laser working insert 12/30°			<b>8654383</b>		
<b>Guide tubes</b>				<b>see UR084</b>	
<b>Also:</b>					
<b>PANOVIEW</b>	<b>Direction of view</b>	<b>∅</b>	<b>WL</b>	<b>TL</b>	<b>Product no.</b>
Telescope 30° ∅ 4 mm WL 300 mm	30°	4.0 mm	300 mm	364 mm	<b>8654.422</b>
Telescope 12° ∅ 4 mm WL 297 mm	12°	4.0 mm	297 mm	363 mm	<b>8654.431</b>
<b>Recommended accessories</b>				<b>Product no.</b>	
Perforated basket for standard telescope 2		Internal dimensions (W x H x D): 454 x 52 x 40 mm External dimensions (W x H x D): 481 x 54 x 59 mm		<b>38016</b>	
Fiber light cable bndl consisting of: Fiber light cable (80662523), projector-side adapter (8095.07), and endoscope-side adapter (809509)		∅ 2.5 mm, 2.3 m long		<b>806625231</b>	

IX23 || Subject to modifications. Please note that some products may not be available in all countries. Please always take note of the information that is provided with the product. For more detailed information, please consult with your contact partner or directly with Richard Wolf GmbH.



# LASER FIBER GUIDE TUBES

## FOR CONTINUOUS IRRIGATION LASER ENUCLEATION SHEATH 26 FR

Laser fiber guide tubes for inner sheath 24 Fr		Fr	Capacity	Product no.
 with lateral guide, distal end straight	Guide tube laser therapy 1,000 µm 22 FR	22 Fr	1,000 µm	8654990
	Guide tube laser therapy 1,000 µm 24 FR	24 Fr		8654991
 with lateral guide, distal end straight	Guide tube laser therapy 600 µm 22 FR	22 Fr	600 µm	8654992
	Guide tube laser therapy 600 µm 24 FR	24 Fr		8654993
 with lateral guide, distal end slanted	Guide tube laser therapy 600 µm 22 FR	22 Fr	600 µm	8654994
	Guide tube laser therapy 600 µm 24 FR	24 Fr		8654995
 with lateral guide, distal end with ring	Guide tube laser therapy 600 µm 22 FR	22 Fr	600 µm	8654996
	Guide tube laser therapy 600 µm 24 FR	24 Fr		8654997
 <b>Curette 22–24 FR</b> for prostate chips		From 22 Fr	600 µm	8654998

**Note:** Laser fiber guide tubes can only be used in conjunction with the laser working element (8654382) and laser working insert (8654383).

IX23 || Subject to modifications. Please note that some products may not be available in all countries. Please always take note of the information that is provided with the product. For more detailed information, please consult with your contact partner or directly with Richard Wolf GmbH.



# BIPOLAR ENUCLEATION

## CONTINUOUS IRRIGATION LASER ENUCLEATION SHEATH, 24/26 FR

FOR **BIPOLAR** ENUCLEATION OF THE PROSTATE



**AUTOCLAVE**  
134° C / 273° F

**CI** Double sheath system

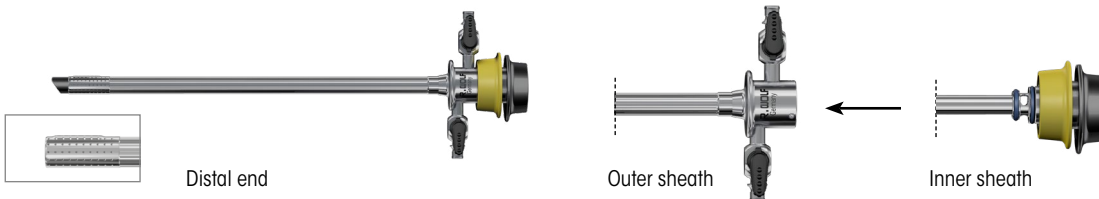

for sheath sizes		SL/WL	Color coding	Product no.
	Outer sheath for resectoscope 26 FR	SL 189 mm	Yellow	<b>8675426</b>
	Inner sheath for resectoscope 24 FR	SL 205 mm		<b>8675324</b>

Also:

	Obturator for resectoscope 24 FR	WL 233 mm	Yellow	<b>8673024</b>
	Viewing obturator for resectoscope 24 FR	WL 232 mm		<b>8673124</b>
	Dilatations obturator f. resectoscope 24 FR	WL 247 mm		<b>8673224</b>

Working element			Product no.
Working element, active, bipo 0/12/30° with handle closed			<b>8680.205</b>

Enucleation electrode bipo 24 FR 12/30°		<b>46400243</b>
---	--	-----------------

Also:

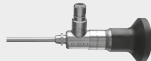

PANOVIEW	Direction of view	Ø	WL	TL	Product no.
Telescope 30° Ø 4 mm WL 300 mm	30°	4.0 mm	300 mm	364 mm	<b>8654.422</b>
Telescope 12° Ø 4 mm WL 297 mm	12°	4.0 mm	297 mm	363 mm	<b>8654.431</b>

Recommended accessories		Product no.
Perforated basket for standard telescope 2	Internal dimensions (W x H x D): 454 x 52 x 40 mm External dimensions (W x H x D): 481 x 54 x 59 mm	<b>38016</b>
Fiber light cable bndl consisting of: Fiber light cable (80662523), projector-side adapter (8095.07), and endoscope-side adapter (809509)	Ø 2.5 mm, 2.3 m long	<b>806625231</b>

IX23 || Subject to modifications. Please note that some products may not be available in all countries. Please always take note of the information that is provided with the product. For more detailed information, please consult with your contact partner or directly with Richard Wolf GmbH.







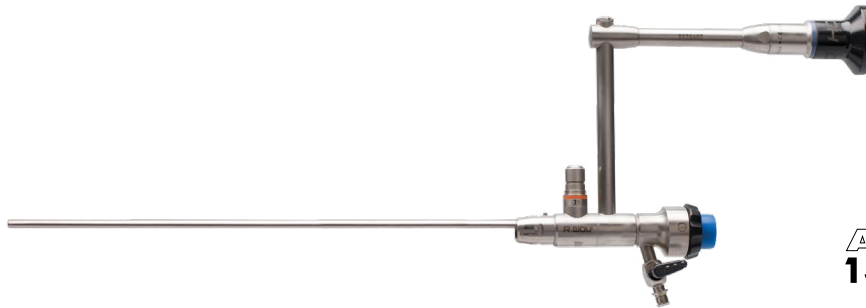

# MORCESCOPE, 0°

IN COMBINATION WITH **SHARK** OUTER SHEATHS  
FOR TISSUE MORCELLATION



**AUTOCLAVE**  
**134° C / 273° F**

PANOVIEW		WL	TL	Product no.
<b>Morcescope 0° 24 FR WL 224 mm</b> Rigid, with parallel eyepiece, working channel for instruments up to 4.8 mm, irrigation via 24.5/26 FR sheath and adapter, suction via morcellator		224 mm	386 mm	<b>8970405</b>
<b>Autom. sealing element ID 5.7 mm</b>				<b>8920.311</b>
Pressure ball for blowing air through channels				<b>103.00</b>
<b>Tube with LUER-LOCK connector</b>				<b>886.00</b>
<b>Cleaning brush Ø 11 mm TL 360 mm</b>				<b>6.01</b>
<b>for connecting "Morcescope" to the 24 Fr and 26 Fr continuous irrigation sheaths</b>				<b>Product no.</b>
<b>Shark adapter for Morcescope 24/26 FR</b>				<b>8675026</b>
<b>CI Double sheath system</b>				
				
for sheath sizes		SL/WL	Color coding	Product no.
<b>CI</b> <b>22/24 Fr</b>	Outer sheath for resectoscope 24 FR	SL 189 mm	Green	<b>8675424</b>
	Inner sheath for resectoscope 22 FR	SL 205 mm		<b>8675322</b>
<b>Also:</b>				
	Obturator for resectoscope 22 FR	WL 232 mm	Green	<b>8673022</b>
	Viewing obturator for resectoscope 22 FR			<b>8673122</b>
<b>CI</b> <b>24/26 Fr</b>	Outer sheath for resectoscope 26 FR	SL 189 mm	Yellow	<b>8675426</b>
	Inner sheath for resectoscope 24 FR	SL 205 mm		<b>8675324</b>
<b>Also:</b>				
	Obturator for resectoscope 24 FR	WL 233 mm	Yellow	<b>8673024</b>
	Viewing obturator for resectoscope 24 FR	WL 232 mm		<b>8673124</b>
	Dilatations obturator f. resectoscope 24 FR	WL 247 mm		<b>8673224</b>
<b>Rotary morcellators and accessories</b>				<b>see UR090</b>



# MORCESCOPE, 0°

IN COMBINATION WITH **SHARK** OUTER SHEATHS  
FOR TISSUE MORCELLATION

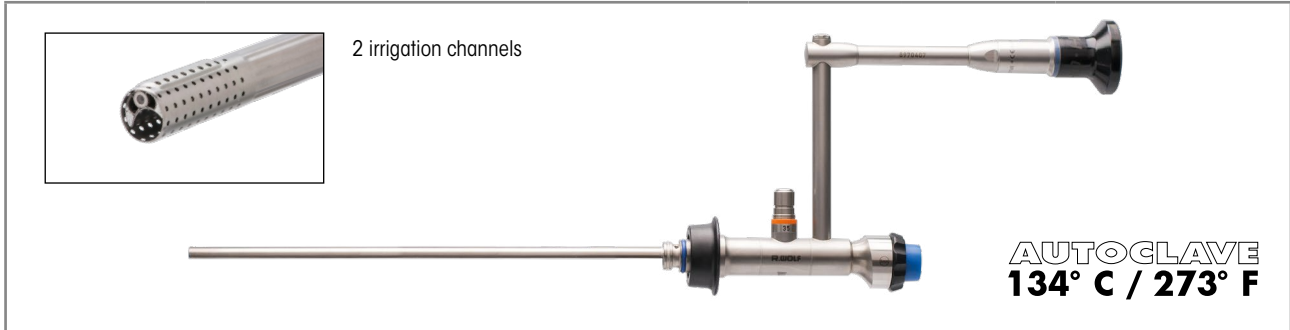

PANOVIEW	WL	TL	Product no.
<b>Morcescope 0° 24 FR WL 199 mm</b> Rigid, with parallel eyepiece, working channel for instruments up to 4.8 mm, irrigation via 24.5/26 FR sheath and adapter, suction via morcellator	199 mm	393 mm	<b>8970407</b>
<b>Autom. sealing element ID 5.7 mm</b>			<b>8920.311</b>
Pressure ball for blowing air through channels			<b>103.00</b>
<b>Tube with LUER-LOCK connector</b>			<b>886.00</b>
<b>Cleaning brush Ø 11 mm TL 360 mm</b>			<b>6.01</b>

**CI** Double sheath system



for sheath sizes		SL/WL	Color coding	Product no.
<b>CI</b> 22/24 Fr	Outer sheath for resectoscope 24 FR	SL 189 mm	Green	<b>8675424</b>
	Inner sheath for resectoscope 22 FR	SL 205 mm		<b>8675322</b>
<b>Also:</b>				
	Obturator for resectoscope 22 FR	WL 232 mm	Green	<b>8673022</b>
	Viewing obturator for resectoscope 22 FR			<b>8673122</b>
<b>CI</b> 24/26 Fr	Outer sheath for resectoscope 26 FR	SL 189 mm	Yellow	<b>8675426</b>
	Inner sheath for resectoscope 24 FR	SL 205 mm		<b>8675324</b>
<b>Also:</b>				
	Obturator for resectoscope 24 FR	WL 233 mm	Yellow	<b>8673024</b>
	Viewing obturator for resectoscope 24 FR	WL 232 mm		<b>8673124</b>
	Dilatations obturator f. resectoscope 24 FR	WL 247 mm		<b>8673224</b>
<b>Rotary morcellators and accessories</b>				<b>see UR090</b>

IX23 || Subject to modifications. Please note that some products may not be available in all countries. Please always take note of the information that is provided with the product. For more detailed information, please consult with your contact partner or directly with Richard Wolf GmbH.









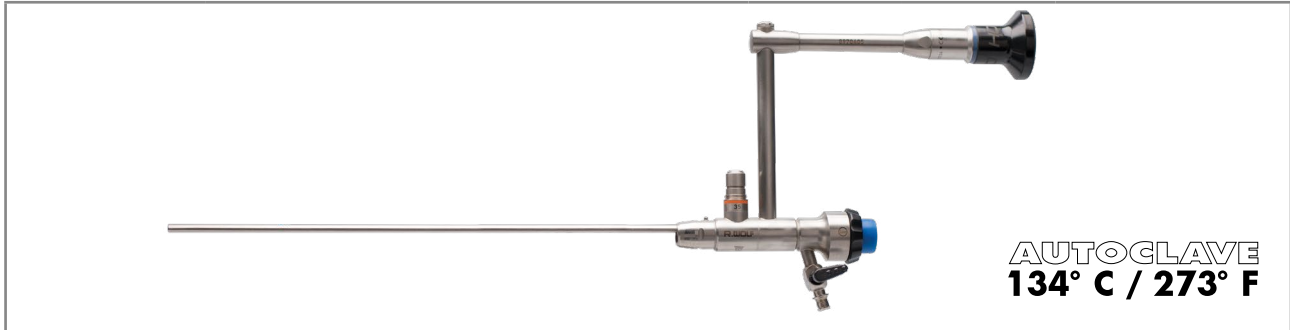

# MORCESCOPE, 0°

IN COMBINATION WITH **E-LINE** OUTER SHEATHS  
FOR TISSUE MORCELLATION







**AUTOCLAVE**  
**134° C / 273° F**

PANOVIEW		WL	TL	Product no.
<b>Morcescope 0° 24 FR WL 224 mm</b> Rigid, with parallel eyepiece, working channel for instruments up to 4.8 mm, irrigation via 24.5/26 FR sheath and adapter, suction via morcellator		224 mm	386 mm	<b>8970405</b>
<b>Autom. sealing element ID 5.7 mm</b>				<b>8920.311</b>
<b>Pressure ball</b> for blowing air through channels				<b>103.00</b>
<b>Tube with LUER-LOCK connector</b>				<b>886.00</b>
<b>Cleaning brush Ø 11 mm TL 360 mm</b>				<b>6.01</b>
for connecting "Morcescope" to the 24 Fr and 26 Fr continuous irrigation sheaths			TL	Product no.
<b>E-Line adapter for Morcescope 26 FR</b>			40 mm	<b>8970.026</b>
<b>CI Double sheath system</b>				
				
for sheath sizes		SL/WL	Color coding	Product no.
<b>CI</b> <b>22/24.5 Fr</b>	Outer sheath for resectoscope 24.5 FR	SL 191 mm	Green	<b>8655.334</b>
	Inner sheath for resectoscope 22 FR	SL 203 mm		<b>8655.344</b>
<b>Also:</b>				
	<b>Obturator for resectoscope 22 FR</b>	WL 230 mm	Green	<b>8654.16</b>
	<b>Viewing obturator for resectoscope 22 FR</b>	WL 232 mm		<b>8415.11</b>
<b>CI</b> <b>24/26 Fr</b>	Outer sheath for resectoscope 26 FR	SL 191 mm	Yellow	<b>8655.374</b>
	Inner sheath for resectoscope 24 FR	SL 204 mm		<b>8655.384</b>
<b>Also:</b>				
	<b>Obturator for resectoscope 24 FR</b>	WL 230 mm	Yellow	<b>8654.17</b>
	<b>Viewing obturator for resectoscope 24 FR</b>	WL 232 mm		<b>8415.12</b>
<b>Rotary morcellators and accessories</b>				<b>see UR090</b>

IX23 || Subject to modifications. Please note that some products may not be available in all countries. Please always take note of the information that is provided with the product. For more detailed information, please consult with your contact partner or directly with Richard Wolf GmbH.

## ROTARY MORCELLATORS/ACCESSORIES FOR THE MORCESCOPE

	for single use (PU = 3 PCS, in individual sterile packaging)	WL	Ø	Product no.
 	<b>Rotary morcellator Ø 4.8 mm WL 335 mm</b>	335 mm	4.8 mm	<b>49700113</b>
	<b>Rotary morcellator Ø 4.8 mm WL 385 mm</b> (for morcellator telescopes <i>from other manufacturers</i> )	385 mm	4.8 mm	<b>49700103</b>

	for multiple use	WL	Ø	Product no.
 	<b>Rotary morcellator Ø 4.8 mm WL 350 mm</b>	350 mm	4.8 mm	<b>8970.011</b>
	<b>Rotary morcellator Ø 4.8 mm WL 385 mm</b> (for morcellator telescopes <i>from other manufacturers</i> )	385 mm	4.8 mm	<b>8970010</b>

Recommended accessories		Product no.
<b>Perforated basket for Morcescope</b> with small parts sieve Holds: standard telescope, for machine reprocessing, sterilization (steam and low-temperature), storage, and transport,	Internal dimensions (W x H x D): 451 x 65 x 164 mm External dimensions (W x H x D): 467 x 75 x 172 mm	<b>38012</b>
<b>Fiber light cable bndl</b> consisting of: Fiber light cable (80663523), projector-side adapter (8095.07), and endoscope-side adapter (809509)	Ø 3.5 mm, 2.3 m long	<b>806635231</b>

# TISSUE MORCELLATOR

FOR MORCELLATION AFTER LASER ENUCLEATION OF THE PROSTATE

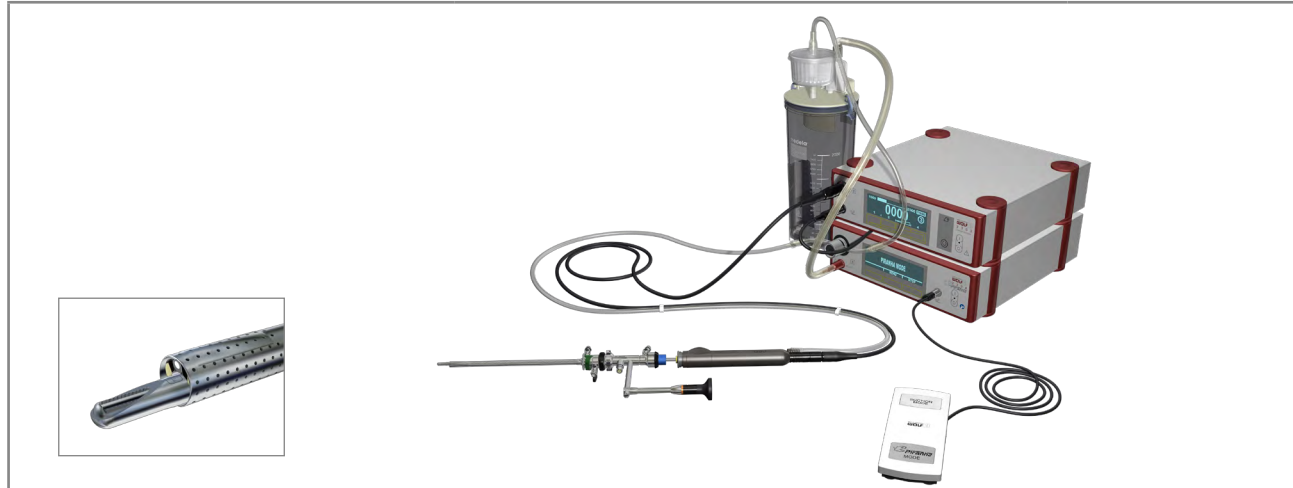

		Product no.
<b>Suction pump bndl</b>	consisting of: Suction pump with LCD display, 100–240 V AC, 50/60 Hz (2208001), 1-pedal footswitch (2030108), bottle holder (64031.381), sound absorber (PU = 3 PCS) (35100.115), RECTO PUMP connection tube (8170.6554), overflow protection/bacteria filter (PU = 10 PCS) (2228.901), secretion container, 2 l (8170.655), and power cable, 3 m long (2440.03)	<b>22080019</b>
<b>Tube for suction</b>	Single use (PU = 10 PCS)	<b>41702208</b>
<b>Collecting container</b>	Disposable (PU = 10 PCS)	<b>2208120</b>
<b>Motor Control Unit 2303</b> for motor handpiece	50/60 Hz, 100–240 V AC	<b>2303.001</b>
Also: <b>Power cable</b>	Cable length 3 m	<b>2440.03</b>
<b>Motor handpiece max. 6,000 rpm</b>	consisting of: Motor handpiece max. 6,000 rpm (8564.021), connection cable, WL 3 m (8564.851), sealing insert – open (15178145)	<b>8564122</b>
<b>Rotary morcellator Ø 4.8 mm WL 335 mm</b>	(PU = 3 PCS) in individual sterile packaging	<b>49700113</b>
<b>Rotary morcellator Ø 4.8 mm WL 385 mm</b>	(PU = 3 PCS) in individual sterile packaging for morcellator telescopes <i>from other manufacturers</i>	<b>49700103</b>
<b>Rotary morcellator Ø 4.8 mm WL 350 mm</b>		<b>8970.011</b>
<b>Rotary morcellator Ø 4.8 mm WL 385 mm</b>		<b>8970010</b>

# MEGA Pulse 70<sup>+</sup>

70 W HOLMIUM:YAG LASER SYSTEM FOR STONE AND BPH THERAPY



"MEGA PULSE 70+" LASER

1.21

	Product no.
<p>MegaPulse 70<sup>+</sup>  <b>Laser surgical device tower EU bndI</b>                      consisting of:                      MegaPulse 70<sup>+</sup> laser surgical device tower 70 W (2286007)                      2x laser protection goggles (OBM003603)                      1x key set (2286525)                      1x door contact plug (2286520)                      2x blast shield with mounting (OAM001523)                      1x filling bottle with tube (IAM000088)                      1x 2-pedal footswitch (2030232)                      1x fiber-stripping forceps for stripping laser fibers, 0.3 to 1.0 mm (2286523)                      1x fiber-stripping forceps for stripping laser fibers, 0.1 to 0.4 mm (2286527)                      1x ceramic cutter with silicone pad (AGM000080)                      1x accessories box for MegaPulse (KBM000103)                      1x power cable TL 3 m (2286230)</p>	<p><b>22860070</b></p>

IX23 || Subject to modifications. Please note that some products may not be available in all countries. Please always take note of the information that is provided with the product. For more detailed information, please consult with your contact partner or directly with Richard Wolf GmbH.

# MEGA Pulse 70<sup>+</sup>

## TECHNICAL DATA

MEGA Pulse 70 <sup>+</sup>		22860070
<b>Device properties</b>		
Display	12" touchscreen	
Power	70 watts	
Laser type	Holmium:YAG laser (Ho:YAG)	
Wavelength	2,100 nm (2.1 µm)	
Operating principle	Pulsed	
Energy	200–5,000 mJ	
Pulse duration	Adjustable (50–1,100 µs)	
Pilot beam	Green: 532 nm, < 5 mW, can be set to continuous or flashing	
Max. operating temperature	10–30 °C	
Storage temperature	Min. +5 °C, max. 40 °C	
<b>Power supply</b>		
Voltage	200–230 V, 50/60 Hz, < 32 A	
Frequency	3–60 Hz	
<b>Dimensions and weights</b>		
Dimensions (W x H x D)	595 x 1,200 x 1,074 mm	
Weight	200 kg	

**MEGA** *Pulse* <sup>70+</sup>  
LASER FIBERS

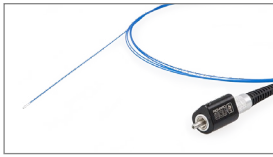

"MEGA PULSE 70+" LASER

1.21

	Sterile (PU= 1 PC)	Core diameter						Product no.	
		200 µm	200 µm	272 µm	365 µm	550 µm	800 µm		1,000 µm
Single use	Power laser fiber Ø 200 µm, disposable	●							487502200
	Laser fiber Ø 200 µm, disposable		●						487501200
	Laser fiber Ø 272 µm, disposable			●					487501272
	Laser fiber Ø 365 µm, disposable				●				4875013650
	Laser fiber Ø 550 µm, disposable					●			487501550
	Laser fiber Ø 800 µm, disposable						●		487501800
	Laser fiber Ø 1,000 µm, disposable							●	4875011000
Multiple use	Power laser fiber Ø 200 µm, reusable	●							87502200
	Laser fiber Ø 200 µm, reusable		●						87501200
	Laser fiber Ø 272 µm, reusable			●					87501272
	Laser fiber Ø 365 µm, reusable				●				875013650
	Laser fiber Ø 550 µm, reusable					●			87501550
	Laser fiber Ø 800 µm, reusable						●		87501800
	Laser fiber Ø 1,000 µm, reusable							●	875011000

IX23 || Subject to modifications. Please note that some products may not be available in all countries. Please always take note of the information that is provided with the product. For more detailed information, please consult with your contact partner or directly with Richard Wolf GmbH.



# MEGA Pulse<sup>70+</sup>

## ACCESSORIES

"MEGA PULSE 70+" LASER

1.21

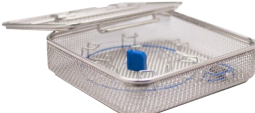
Accessories		Product no.	
Fiber-stripping forceps, autoclavable	for stripping laser fibers	Ø 200–272 µm	<b>AGM000053</b>
		Ø 365–400 µm	<b>AGM000078</b>
		Ø 550–600 µm	<b>AGM000052</b>
		Ø 800 µm	<b>AGM000064</b>
Fiber-stripping forceps	for stripping laser fibers	Ø 0.1–0.4 mm	<b>2286527</b>
		Ø 0.3–1.0 mm	<b>2286523</b>
Ceramic cutter with silicone pad		<b>AGM000080</b>	
Filling bottle with tube		<b>IAM000088</b>	
Laser protection goggles	(Also suitable for glasses-wearers)	<b>OBM003603</b>	
2-pedal footswitch		<b>2030232</b>	
Key set		<b>2286525</b>	
Door contact plug		<b>2286520</b>	
Blast shield with mounting		<b>OAM001523</b>	
Power cable TL 3 m		<b>2286230</b>	
Accessories box for MegaPulse		<b>KBM000103</b>	
Adapter cable	CEE coupling, 3-pin 32 A 6 h 230 V AC blue (on the device side) and CEE plug, 5-pin 32 A 6 h 400 V AC red (in-house)	<b>100-201-0518</b>	

Machine reprocessing		Product no.
 <b>Perforated basket for laser fiber</b>	Holds: Laser fiber, for machine reprocessing, sterilization (steam and low-temperature), storage, and transport; internal dimensions (W x H x D): 231 x 52 x 223 mm external dimensions (W x H x D): 248 x 72 x 239 mm	<b>38001</b>
Also:  <b>Fixing ring Ø 34.6 mm</b>	for holding instruments during machine reprocessing, sterilization (steam and low-temperature), storage, and transport, Ø 34.6 x 2.62 mm, PU = 5 PCS	<b>643301262</b>

IX23 || Subject to modifications. Please note that some products may not be available in all countries. Please always take note of the information that is provided with the product. For more detailed information, please consult with your contact partner or directly with Richard Wolf GmbH.

# Pulvis 60<sup>+</sup>

60 W THULIUM FIBER LASER (TFL)

FOR STONE THERAPY AND ENDOSCOPIC ENUCLEATION OF THE PROSTATE (EEP)

"PULVIS 60<sup>+</sup>" LASER

1.22



		Product no.
<p><b>Pulvis 60<sup>+</sup></b> 60 W thulium fiber laser (TFL)</p>	<p><b>PFMS00006</b></p>	

IX23 || Subject to modifications. Please note that some products may not be available in all countries. Please always take note of the information that is provided with the product. For more detailed information, please consult with your contact partner or directly with Richard Wolf GmbH.



# Pulvis 60<sup>+</sup>

## 60 W THULIUM FIBER LASER (TFL)

### TECHNICAL DATA

Pulvis 60 <sup>+</sup>		PFMS00006	
<b>Device properties</b>			
Display	Fold-out, rotatable touchscreen display (rotates 90° to the right and 180° to the left)		
Operating temperature	15–30 °C (at a room temperature between 25 °C and 30 °C, operation is guaranteed with a maximum output power of up to 40 W)		
Storage/transport temperature	Min. +5 °C/max. 40 °C		
Atmospheric pressure	800–1,060 hPa		
Operating humidity	30–85 %, non-condensing		
Max. noise level	< 70.0 dB		
<b>Equipment</b>			
Cooling method	Air cooling system		
<b>Power supply</b>			
Mains + frequency	100–240 V AC, 50/60 Hz		
Power consumption	1,000 VA		
<b>Regulatory standards</b>			
Classification according to the Medical Devices Directive 93/42/EEC	Class IIb		
Laser classification according to IEC/EN 60825-1:2014	Class 4		
Pilot beam classification according with IEC/EN 60825-1:2014	Class 3R		
<b>Dimensions and weights</b>			
Weight	100 kg		
Dimensions (W x H x D)	470 x 1,156 x 810 mm 470 x 940 x 810 mm – display closed		

# Pulvis 60<sup>+</sup>

## 60 W THULIUM FIBER LASER (TFL)

### TECHNICAL DATA

Pulvis 60 <sup>+</sup>		PFMS00006
<b>Laser source specifications</b>		
Laser type	Thulium fiber-laser	
Wavelength	1,940 nm ± 20 nm	
Maximum output power	60 W (pulsed/CW)	
Pulse energy	0.02–6 J	
Operating mode	Pulsed/CW	
Pulse duration	50 µs – CW	
Frequency of recurrence	1–2,500 Hz	
Delivery system	Large selection of laser fibers (see next page) (sterile, disposable, and reusable)	
Pilot beam	Green 532 nm (adjustable) < 5 mW, class 3R	
Goggles	1940 D LB4	

# Pulvis 60<sup>+</sup>

## LASER FIBERS

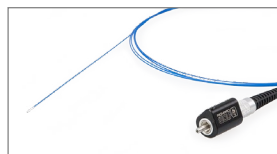

Sterile (PU= 10 PC)		Core diameter									Product no.
		150 µm	200 µm	272 µm	365 µm	500 µm	550 µm	600 µm	800 µm	1,000 µm	
Single use	Single use optical fiber 150 µm	●									OFJ001511
	Single use optical fiber 200 µm		●								OFJ002011
	Single use optical fiber 272 µm			●							OFJ702711
	Single use optical fiber ball tip 272 µm			●							OFJ302711
	Single use optical fiber 365 µm				●						OFJ703611
	Single use optical fiber 550 µm						●				OFJ005511
	Single use optical fiber lateral 600 µm							●			OFJ506011
	Single use optical fiber 800 µm								●		OFJ008011
	Single use optical fiber 1,000 µm									●	OFJ009911
Multiple use	Reusable 10x optical fiber 200 µm		●								OFJ002013
	Reusable 10x optical fiber 272 µm			●							OFJ702713
	Reusable 10x optical fiber 365 µm				●						OFJ703613
	Reusable 10x optical fiber 500 µm					●					OFJ005513
	Reusable 10x optical fiber 800 µm								●		OFJ008013
	Reusable 10x optical fiber 1,000 µm									●	OFJ009913

# Pulvis 60<sup>+</sup>

## ACCESSORIES

Accessories	Product no.
Interlock Conn. Medical Devices Binder	EAM000045.00
Key	MBQ000190.00
Power cord-5m-spina Shuko 16A EUR	EAM001440.00
Fiberstripper optical fibers Ø300-1000 µm	OBM001079.00
Fiberstripper optical fibers Ø100-400 µm	OBM001080.00
Case salsa 1650 no brand accessories	KBM000103.01
Ceramic fiber cutter with slipcase	AGM000080.00
Goggle protection f18.P1d09.1003	OBM003778.00
Optical blast shield for ffl ext-access	OAM002112.00

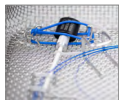
Machine reprocessing	Product no.
 <p><b>Perforated basket for laser fiber</b></p> <p>Holds: Laser fiber, for machine reprocessing, sterilization (steam and low-temperature), storage, and transport; internal dimensions (W x H x D): 231 x 52 x 223 mm external dimensions (W x H x D): 248 x 72 x 239 mm</p>	<b>38001</b>
<p>Also:</p>  <p><b>Fixing ring Ø 34.6 mm</b></p> <p>for holding instruments during machine reprocessing, sterilization (steam and low-temperature), storage, and transport, Ø 34.6 x 2.62 mm, PU = 5 PCS</p>	<b>643301262</b>

IX23 || Subject to modifications. Please note that some products may not be available in all countries. Please always take note of the information that is provided with the product. For more detailed information, please consult with your contact partner or directly with Richard Wolf GmbH.

# HF GENERATOR 2260



		Product no.
HF surgical generator 400 kHz	for the connection of monopolar and bipolar accessories, international version (BOWA, KLS Martin, Olympus, Karl Storz, Valleylab)	2260001
HF surgical generator 400 kHz	for the connection of monopolar and bipolar accessories, E version (Erbe)	2260002

HF GENERATOR 2260  
1.23

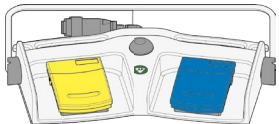
Accessories required	Cable length	Product no.
<b>Footswitch, 2 pedals L 5 m</b> with fixed connection cable, reusable 		2260021
<b>Neutral electrode</b> for use with high-frequency surgical device, foil bag with 5 neutral electrodes (PU = 50 PCS)		1280H
<b>Mono HF neutral electrode cable, L 4.5 m</b>	4.5 m	2260031
<b>Power cable</b>	3.0 m	2440.03
<b>Bipo HF connection cable L 3 m</b>	3.0 m	8108233
<b>Bipo HF connection cable L 5 m</b>	5.0 m	8108253

# HF GENERATOR 2260







## TECHNICAL DATA

HF surgical generator 400 kHz		2260001/2260002
<b>Device properties</b>		
Type of controls on housing front		Touch panel
Output power	Max. cutting power	400 W
	Max. coagulation power	350 W
LF and HF leakage currents		Acc. to DIN EN 60601-1 and DIN EN 60601-2-2
Signal level		HF indicator 55 dB(A); adjustable 45–60 dB(A) Alarm 65 dB(A)
Operating conditions		+10 °C to +40 °C, 30 % to 75 % rel. humidity, 700 hPa to 1,060 hPa atmospheric pressure
Storage and transport conditions		-20 °C to +60 °C, 10 % to 90 % rel humidity, 700 hPa to 1,060 hPa atmospheric pressure
<b>Power supply</b>		
Mains + frequency		100–240 V AC, 50/60 Hz
Power consumption	without HF output	45 VA
	at max. output power	650 VA
Current consumption		Max. 6.3 A
Fuse		T 6.3 AH 250 V
<b>Regulatory standards</b>		
Protection class to EN/IEC 60601-1 (UL 2601-1/CSA C22.2 No.601.1 – for USA)		I
Electromagnetic compatibility (EMC)		EN/IEC 60601-1-2
Medical Devices Directive 93/42/EEC		Class IIb
Degree of protection against the ingress of liquids (DIN EN/IEC 60529)		IP X0
Degree of protection against the ingress of solids		IP 2X
Duty factor (duty cycle DC)		Intermittent INT 10 s/30 s corresponding to 25 % DC
Protection against electric shock		Type CF applied part, defibrillator-proof
Degree of protection in the presence of flammable mixtures		Device is not protected against explosions (do not operate this device in explosive atmospheres)
<b>Dimensions and weights</b>		
Weight		10.2 kg (22.4 lbs)
Dimensions (W x H x D)		300 x 159 x 419 mm

# HF CONNECTION CABLE MONO 815XXX

HF CONNECTION CABLE

1.24

Instrument connector	Device connector		Product no.
<p><b>WOLF Resectoscopes</b></p> 		<p>HF connection cable mono L 3 m</p>	<p><b>815.032</b></p>
	<p>ERBE (ACC/ICC/IO)/BOWA (EU) R. Wolf HF surgical generator 400 kHz 2260002</p>	<p>HF connection cable mono L 5 m</p>	<p><b>815.052</b></p>
		<p>HF connection cable mono L 3 m</p>	<p><b>815.132</b></p>
	<p>ERBE (T series)</p>	<p>HF connection cable mono L 5 m</p>	<p><b>815.152</b></p>
<p><b>HF electrodes, monopolar</b></p> 		<p>HF connection cable mono L 3 m</p>	<p><b>815.031</b></p>
	<p>Martin (M-version)/Berchtold/ Aesculap</p>	<p>HF connection cable mono L 5 m</p>	<p><b>815.051</b></p>
		<p>HF connection cable mono L 3 m</p>	<p><b>815.033</b></p>
	<p>Bovie/Valleylab/Erbe (Int.)/ BOWA (Int.) R. Wolf HF surgical generator 400 kHz 2260001</p>	<p>HF connection cable mono L 5 m</p>	<p><b>815.053</b></p>
		<p>HF connection cable mono L 3 m</p>	<p><b>815.034</b></p>
	<p>BOWA (Int./EU) Eschmann and other devices with 4 mm plugs R. Wolf HF surgical generator 400 kHz 2260001</p>	<p>HF connection cable mono L 5 m</p>	<p><b>815.054</b></p>

IX23 || Subject to modifications. Please note that some products may not be available in all countries. Please always take note of the information that is provided with the product. For more detailed information, please consult with your contact partner or directly with Richard Wolf GmbH.

# HF CONNECTION CABLE MONO 8106xxx

HF CONNECTION CABLE

1.24

Instrument connector	Device connector		Product no.	
<p><b>WOLF Instruments/surgical generator</b></p> 	 <p>ERBE (ACC/ICC/IO)/BOWA (EU) R. Wolf HF surgical generator 400 kHz 2260002</p>	HF connection cable mono L 3 m	<b>8106.032</b>	
		HF connection cable mono L 5 m	<b>8106.052</b>	
	 <p>ERBE (T series)</p>	HF connection cable mono L 3 m	<b>8106.132</b>	
		HF connection cable mono L 5 m	<b>8106.152</b>	
	<p><b>HF electrodes, monopolar</b></p> 	 <p>Martin (M-version)/Berchtold/ Aesculap</p>	HF connection cable mono L 3 m	<b>8106.031</b>
			HF connection cable mono L 5 m	<b>8106.051</b>
		 <p>Bovie/Valleylab/Erbe (Int.)/ BOWA (Int.) R. Wolf HF surgical generator 400 kHz 2260001</p>	HF connection cable mono L 3 m	<b>8106.033</b>
			HF connection cable mono L 5 m	<b>8106.053</b>
	 <p>BOWA (Int./EU) Eschmann and other devices with 4 mm plugs R. Wolf HF surgical generator 400 kHz 2260001/2260002</p>	HF connection cable mono L 3 m	<b>8106.034</b>	
		HF connection cable mono L 5 m	<b>8106.054</b>	









IX23 || Subject to modifications. Please note that some products may not be available in all countries. Please always take note of the information that is provided with the product. For more detailed information, please consult with your contact partner or directly with Richard Wolf GmbH.

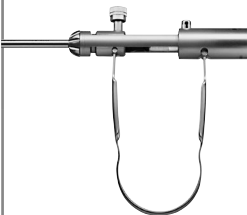

# HF CONNECTION CABLE BIPO 8108XXX

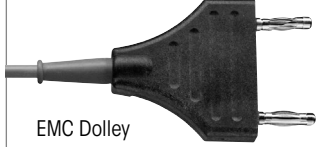
HF CONNECTION CABLE



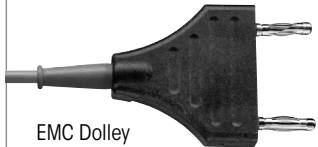

1.24

Instrument connector	Device connector		Product no.	
<p><b>WOLF Bipolar forceps</b></p> 	 ERBE (ACC/ICC/T)/BOWA (EU) R. Wolf HF surgical generator 400 kHz 2260001/2260002	HF connection cable bipo; L 3 m	<b>8108.032</b>	
		HF connection cable bipo; L 5 m	<b>8108.052</b>	
	 International / 2-pin Valleylab R. Wolf HF surgical generator 400 kHz 2260001/2260002	HF connection cable bipo; L 3 m	<b>8108.033</b>	
		HF connection cable bipo; L 5 m	<b>8108.053</b>	
	 WOLF/Martin (M-version)/ Berchtold/Aesculap	HF connection cable bipo; L 3 m	<b>8108.031</b>	
		HF connection cable bipo; L 5 m	<b>8108.051</b>	
	 EMC Dolley	HF connection cable bipo; L 3 m	<b>8108035</b>	
	<p><b>Bipolar tweezers connection</b></p> 	 ERBE (ACC/ICC/T)/BOWA (EU) R. Wolf HF surgical generator 400 kHz 2260001/2260002	HF connection cable bipo; L 3 m	<b>8108.132</b>
			HF connection cable bipo; L 5 m	<b>8108.152</b>
		 International / 2-pin Valleylab R. Wolf HF surgical generator 400 kHz 2260001/2260002	HF connection cable bipo; L 3 m	<b>8108.133</b>
		HF connection cable bipo; L 5 m	<b>8108.153</b>	
 Martin (M-version)/Berchtold/ Aesculap		HF connection cable bipo; L 3 m	<b>8108.131</b>	
		HF connection cable bipo; L 5 m	<b>8108.151</b>	
 EMC Dolley		HF connection cable bipo; L 3 m	<b>8108135</b>	

IX23 || Subject to modifications. Please note that some products may not be available in all countries. Please always take note of the information that is provided with the product. For more detailed information, please consult with your contact partner or directly with Richard Wolf GmbH.

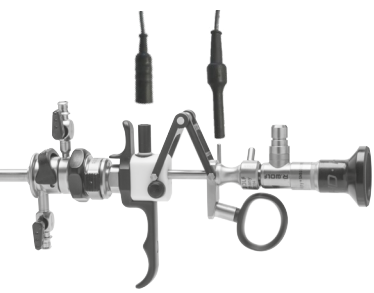
# HF CONNECTION CABLE BIPO FOR RESECTION IN SALINE SOLUTION

HF CONNECTION CABLE  
1.24

Instrument connector	Device connector		Product no.
<p><b>WOLF S(a)line resectoscopes</b></p> 	 Erbe VIO 300D	<p><b>Bipolar cable; TUR/TCR; WOLF</b></p> <p>MF plug; L 4 m</p>	<p><b>20196-119</b></p>
	 Erbe VIO 3	<p><b>BIPOLAR CABLE; MF-U</b></p> <p>MF plug; L 4.5 m</p>	<p><b>21196-119</b></p>
	 KLS Martin	<p><b>HF connection cable bipo; L 3 m</b></p>	<p><b>8108.231</b></p>
		<p><b>HF connection cable bipo; L 5 m</b></p>	<p><b>8108.251</b></p>
	 R. Wolf HF surgical generator 400 kHz 2260001/2260002	<p><b>HF connection cable bipo; L 3 m</b></p>	<p><b>8108233</b></p>
		<p><b>HF connection cable bipo; L 5 m</b></p>	<p><b>8108253</b></p>

IX23 || Subject to modifications. Please note that some products may not be available in all countries. Please always take note of the information that is provided with the product. For more detailed information, please consult with your contact partner or directly with Richard Wolf GmbH.

# FLUID CONTROL 2225

## SUCTION IRRIGATION PUMP



		Product no.
<b>FLUID CONTROL 2225</b> <b>Irrigation pump for HYS/URO/LAP bndI</b> consisting of: Irrigation pump for HYS/URO/LAP (2225001) and power cable 3 m long (2440.03)		<b>22250011</b>
<b>Also:</b>		
<b>Balancing module</b> for hysteroscopy and endourology, fluid management for fluid balancing in combination with FLUID CONTROL 2225, mobile stand with integrated weighing cells and space for up to 4 irrigation fluid bags		<b>2225023</b>

Accessories		Product no.
<b>Footswitch</b>	Only for use in urology and within the indication TUR/enucleation, possibility of short-term increase in pressure if visibility is poor (Flush function)	<b>2204901</b>

Cable accessories		Product no.
<b>Patch cable, RJ45 SFTP, 0.5 m</b>	Cable length 0.5 m	<b>72325378</b>
<b>Patch cable, RJ45 HRS TM11, 1.0 m</b>	Cable length 1.0 m	<b>72325429</b>
<b>Patch cable, RJ45 S/FTP CAT.6 10 m</b>	Cable length 10 m	<b>72325434</b>
<b>Plastic caps for network socket</b>	(PU = 8 PCS)	<b>5592105</b>
<b>Power cable</b>	Cable length 3 m	<b>2440.03</b>

FLUID CONTROL 2225

1.25

# FLUID CONTROL 2225

## SUCTION IRRIGATION TUBE SETS

Irrigation			Product no.
<b>Accessories – reusable</b>	<b>Tube set with piercing spike</b>	with LUER-LOCK connection, autoclavable, incl. 10 spare membranes, reusable for 20 reprocessing cycles	<b>8171223</b>
<b>Accessories – disposable</b>	<b>Irrigation tube set with piercing spike, L 3 m</b>	(PU = 10 PCS), with LUER-LOCK connection, sterile, disposable product	<b>4171223</b>
	<b>Tube set with CARE-LOCK, L 3 m</b>	(PU = 10 PCS), sterile, disposable product	<b>4171224</b>
	<b>Suction irrigation tube set</b>	(PU = 10 PCS), with piercing spike, sterile, disposable product, PVC	<b>4171225</b>
	<b>Day irrigation tube set</b>	(PU = 10 PCS), sterile, disposable product, PVC	<b>4171226</b>
	<b>Patient irrigation tube set, sterile</b>	(PU = 10 PCS), with LUER-LOCK connection, sterile, disposable product, PVC	<b>4171227</b>
<i>Note: Day tube and patient tube can only be used together. A new patient tube is required for each patient – the day tube can be used for up to 20 patients.</i>			

Suction			Product no.
<b>Accessories – reusable</b>	<b>Tube set for vacuum, incl. filter</b>	with integrated hygiene filter, PU = 10 PCS, service life 30 days (connected to irrigation pump)	<b>2206207</b>
	<b>Irrigation tube</b>	L 1.2 m, with LUER-LOCK, for suction irrigation handle 8385.901 and tube set 8171223 or 8170.223	<b>817123</b>
	<b>Suction tube L 3 m</b>	for suction irrigation handle 8385.901	<b>8171402</b>
	<b>Secretion container 2 l</b>	2 liters, with lid	<b>8170.655</b>
	<b>Secretion container 2 l</b>	2 liters, no lid	<b>8170.6551</b>
<b>Accessories – disposable</b>	<b>Secretion container 2.5 l</b>	2.5 liters	<b>41706566</b>
	<b>Secretion container bndl consisting of:</b>	Secretion container 2.5 l (41706566) and secretion bag (PU = 90 PCS) (41706564)	<b>4170657</b>
	<b>Tube set for suction (2 connections)</b>	Sterile, disposable product (PU = 10 PCS) for connecting instruments to collecting container	<b>T0503-01</b>
	<b>Angled 90° plug-in coupling</b>	(PU = 10 PCS) for connecting vacuum tube 2206207 to disposable container systems	<b>0771019</b>

# TECHNICAL DATA

## FLUID CONTROL 2225

FLUID CONTROL 2225		2225001
<b>Device properties</b>		
Operating conditions		+10 °C to +40 °C, 30 % to 75 % rel. humidity, 70 to 106 kPa atmospheric pressure 3,000 m max. altitude above sea level
Storage and transport conditions		-20 °C to +60 °C, 10 % to 90 % rel. humidity, 70 to 106 kPa atmospheric pressure
<b>Power supply</b>		
Mains + frequency		100–240 V AC, 50/60 Hz
Power consumption	100 V/60 Hz	110 VA
	240 V/50 Hz	120 VA
Current consumption	100 V/60 Hz	1.10 A
	240 V/50 Hz	0.50 A
Fuse		T 3.15 AH, 250 V
<b>Regulatory standards</b>		
Protection class (I, II)		I
Electromagnetic compatibility (EMC)		EN 60601-1/IEC 60601-1 EN 60601-1-2/IEC 60601-1-2
Medical Devices Directive 93/42/EEC		Class IIb
Housing protection rating (IP code)		IP 21
Protection against electric shock		Type BF applied part
Degree of protection in the presence of flammable mixtures		Device is not protected against explosions (do not operate this device in explosive atmospheres)
Maximum suction vacuum		-60 kPa
<b>Dimensions and weights</b>		
Weight		8.8 kg
Dimensions (W x H x D)		300 mm x 157 mm x 436 mm

Relevant application parameters	
Nominal flow range	Hysteroscopy: 800 ml/min (max. flow, not adjustable) Endourology: 10–800 ml/min (max. flow) Laparoscopy: 0.1–1.8 l/min (max. flow)
Suction power	Max. 2 l/min
Starting nominal pressure range	Hysteroscopy: 15–200 mmHg Endourology: 15–90 mmHg/20–120 cmH2O Laparoscopy: 300 mmHg (not adjustable)
Pressure	0–300 mmHg
Deficit	-9,990 to +9,990 ml/0 to 99.9 l

# TECHNICAL DATA

## FLUID CONTROL 2225

Balancing module <b>2225023</b>	
<b>Device properties</b>	
Operating conditions	+10 °C to +40 °C, 30 % to 75 % rel. humidity, 70 to 106 kPa atmospheric pressure 3,000 m max. altitude above sea level
Storage and transport conditions	-20 °C to +60 °C, 10 % to 90 % rel. humidity, 70 to 106 kPa atmospheric pressure
<b>Regulatory standards</b>	
Electromagnetic compatibility (EMC)	EN 60601-1/IEC 60601-1 EN 60601-1-2/IEC 60601-1-2
Housing protection rating (IP code)	IP 21
Maximum load of container scale	16 kg/4 containers of 3 l each
Maximum load of bag scale	23 kg/4 bags of 5 l each
<b>Dimensions and weights</b>	
Weight	15.4 kg
Dimensions (W x H x D)	618 mm x 1,064 mm x 618 mm

Footswitch <b>2204901</b>	
<b>Power supply</b>	
Power supply connection	Max. 24 V
Power consumption	Max. 0.1 A
<b>Regulatory standards</b>	
Electromagnetic compatibility (EMC)	EN 60601-1/IEC 60601-1
Housing protection rating (IP code)	IP X8
Plug	7-pin circular connector
Cable length	4.5 m
<b>Dimensions and weights</b>	
Weight	300 g
Dimensions (W x H x D)	66 mm x 27 mm x 91 mm

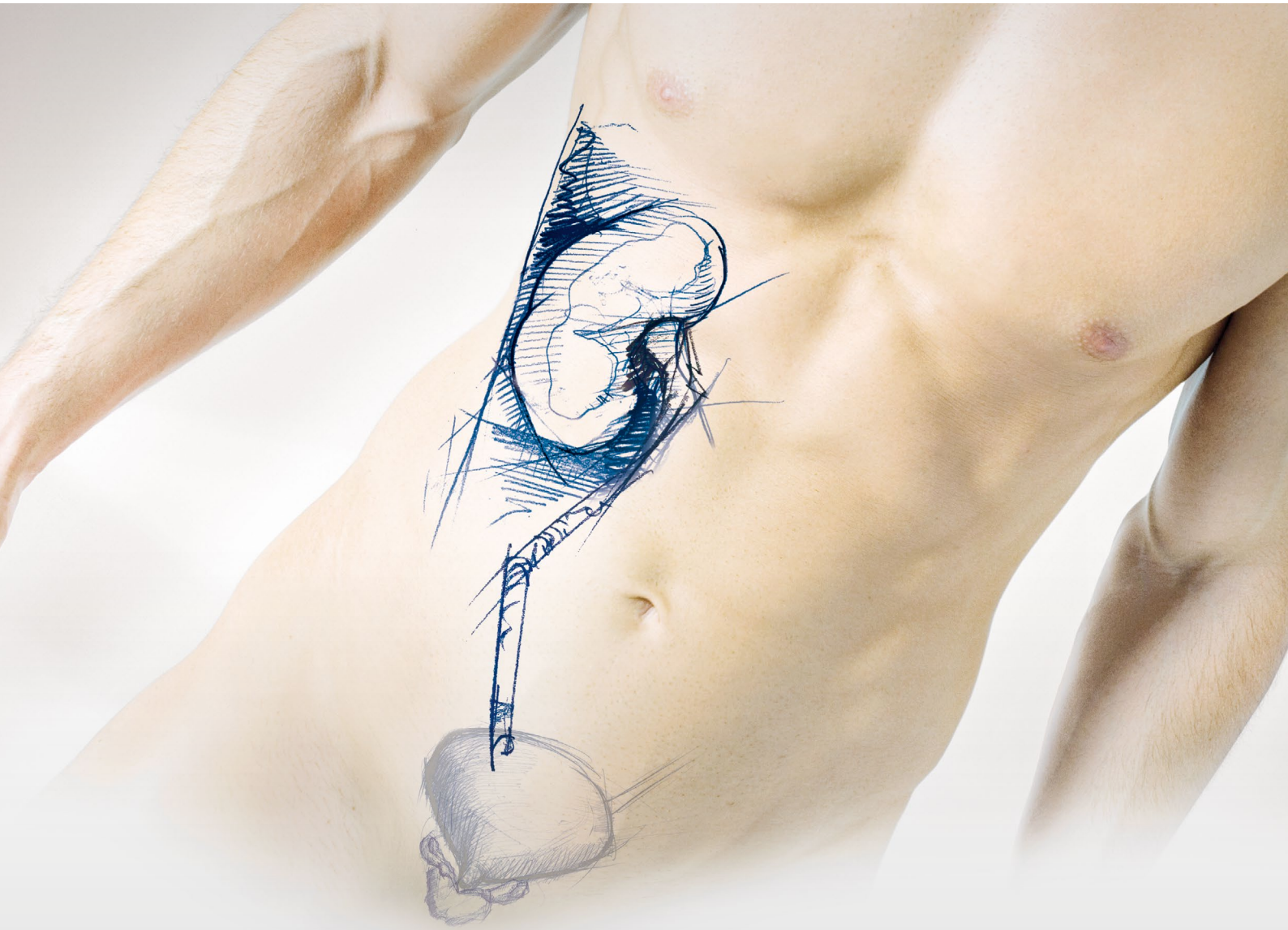

## UPPER URINARY TRACT



## UPPER URINARY TRACT

### URETERORENOSCOPY

2.1 "E-LINE" URETERORENOSCOPE / FIBER URETERORENOSCOPES / CONTINUOUS IRRIGATION URETERORENOSCOPES

2.2 FLEXIBLE FIBER URS 270° – THE VIPER

2.3 FLEXIBLE 2-CHANNEL CONTINUOUS IRRIGATION LASER URS – THE COBRA

2.4 FLEXIBLE 1-CHANNEL SENSOR URETERORENOSCOPES - BOA vision / BOA vision EF

2.5 FLEXIBLE 2-CHANNEL SENSOR URETERORENOSCOPES – COBRA vision / COBRA vision EF

2.6 DISPOSABLE SENSOR URETERORENOSCOPE – RIWO D-URS

### NEPHROSCOPY

2.7 DILATORS FOR PERCUTANEOUS UNIVERSAL NEPHROSCOPES

2.8 MINI NEPHROSCOPE BY LAHME

2.9 PERCUTANEOUS UNIVERSAL NEPHROSCOPE, "DRESDEN MODEL"

2.10 PERCUTANEOUS UNIVERSAL NEPHROSCOPES

2.11 FLEXIBLE FIBER NEPHROSCOPE

### LASER ENERGY SOURCES

2.12 "MEGA PULSE 70+" HOLMIUM:YAG LASER (Ho:YAG)

2.13 "PULVIS 60+" THULIUM FIBER LASER (TFL)

### SUCTION IRRIGATION PUMP

2.14 FLUID CONTROL 2225



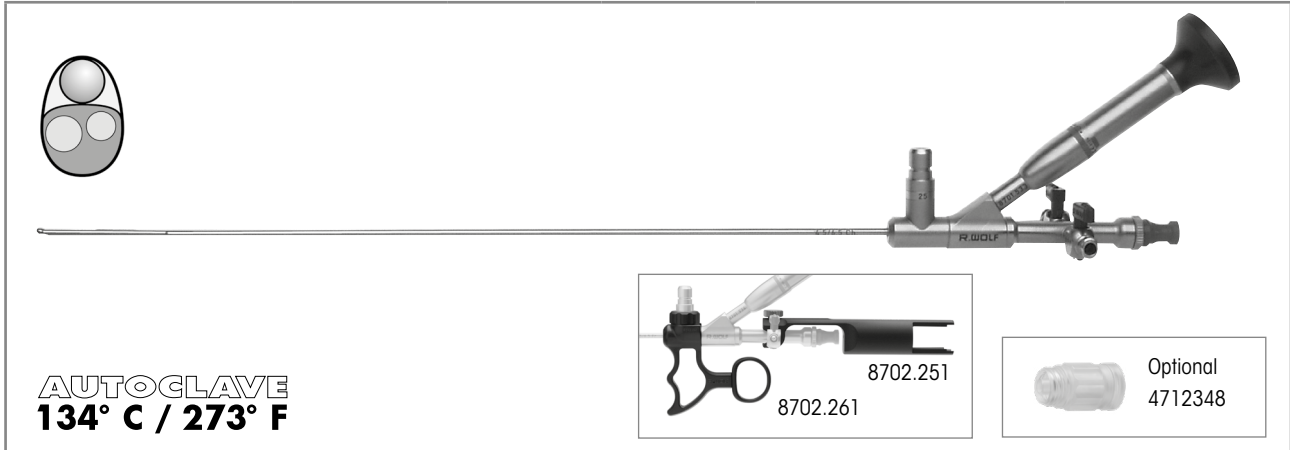

*E-line*

**ULTRA-THIN FIBER URETERORENOSCOPE**  
WITH LATERAL EYEPIECE

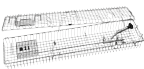

	WL	TL	Direction of view	Endoscope tip/Sheath tube	Working channel	Product no.
<b>Ureterorenoscope 5°</b> <b>4.5/6.5 FR WL 430 mm</b> Atraumatically shaped tip	430 mm	555 mm	5°	4.5/6.5 Fr	3 Fr	<b>8701.534</b>

Recommended accessories		Product no.
	Flex. grasping forceps 3 FR WL 530 mm	<b>828.605</b>
	Flex. biopsy forceps 3 FR WL 530 mm	<b>829.603</b>
Handle for E-Line ureterorenoscopes		<b>8702.261</b>
Guide element for ureterorenoscope for LITHOCLAST handpieces		<b>8702.251</b>
for inserting auxiliary instruments of 1–6 FR: <b>universal sealing valve 1–6 FR</b> , sterile (PU = 5 PCS)		<b>4712348</b>
<b>Membrane holder</b> standard		<b>15256.393</b>
<b>Membrane holder</b> with Luer		<b>15256.456</b>
<b>Seal Ø 7.5 mm</b> (PU = 10 pcs)		<b>89.101</b>
<b>Perforated basket, upper urinary tract 1</b> with small part basket	 Internal dimensions (W x H x D): 619 x 65 x 124 mm External dimensions (W x H x D): 35 x 75 x 132 mm	<b>38003</b>
<b>Marking pen, black</b>		<b>38201.948</b>
<b>Fiber light cable bndl</b> consisting of: Fiber light cable (80662523), projector-side adapter (8095.07), and endoscope-side adapter (809509)	Ø 2.5 mm, 2.3 m long	<b>806625231</b>
<b>Auxiliary instruments</b>		see URO119

IX23 || Subject to modifications. Please note that some products may not be available in all countries. Please always take note of the information that is provided with the product. For more detailed information, please consult with your contact partner or directly with Richard Wolf GmbH.

E-line

FIBER URETERORENOSCOPE  
WITH STRAIGHT EYEPIECE

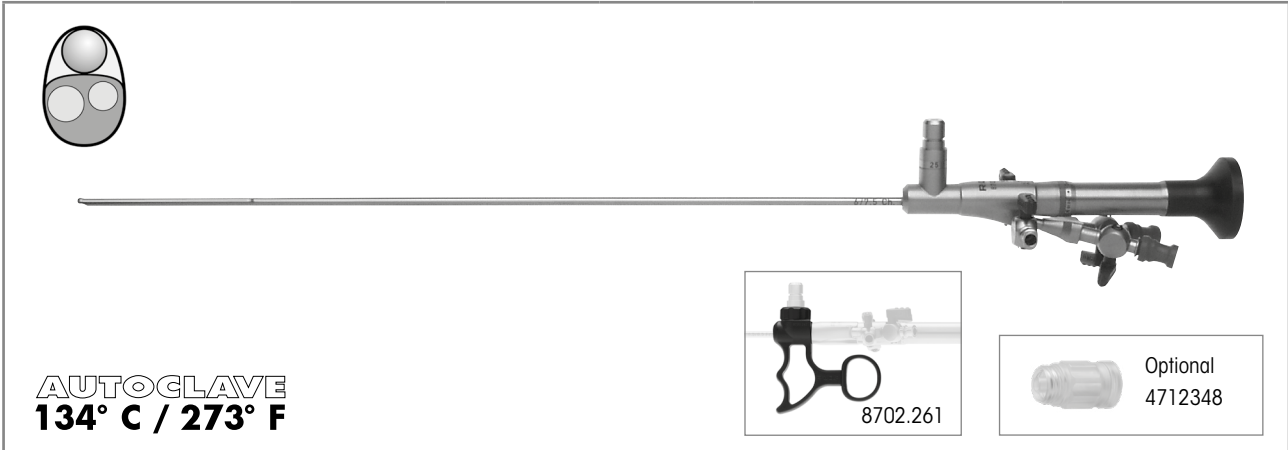

**AUTOCLAVE**  
**134° C / 273° F**

	WL	TL	Direction of view	Endoscope tip/Sheath tube	Working channel	Product no.
<b>Ureterorenoscope 5°</b> <b>6/7.5 FR WL 430 mm</b> Atraumatically shaped tip	430 mm	558 mm	5°	6/7.5 Fr	1 x 4 Fr or 2 x 2.2 Fr	<b>8702.514</b>
<b>Ureterorenoscope 12°</b> <b>8/9.8 FR WL 430 mm</b> Atraumatically shaped tip	430 mm	558 mm	12°	8/9.8 Fr	1 x 5 Fr or 2 x 3 Fr	<b>8703.514</b>

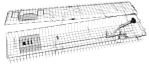
Recommended accessories		Product no.
Handle for E-Line ureterorenoscopes		<b>8702.261</b>
for inserting auxiliary instruments of 1–6 FR: <b>universal sealing valve 1–6 FR</b> , sterile (PU = 5 PCS)		<b>4712348</b>
<b>Perforated basket, upper urinary tract 1</b> with small part basket	 Internal dimensions (W x H x D): 619 x 65 x 124 mm External dimensions (W x H x D): 635 x 75 x 132 mm	<b>38003</b>
<b>Marking pen, black</b>		<b>38201.948</b>
<b>Fiber light cable bndl</b> consisting of: Fiber light cable (80662523), projector-side adapter (8095.07), and endoscope-side adapter (809509)		Ø 2.5 mm, 2.3 m long <b>806625231</b>
<b>Auxiliary instruments</b>		<b>see URO119</b>

*E-line*

**FIBER URETERORENOSCOPE  
WITH LATERALLY OFFSET EYEPIECE**

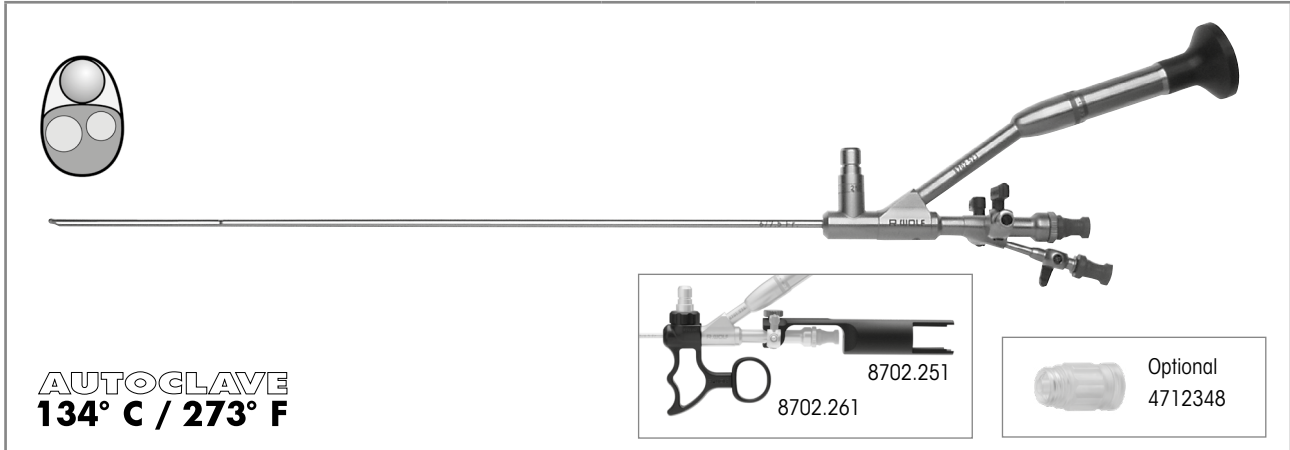

**AUTOCLAVE  
134° C / 273° F**

	WL	TL	Direction of view	Endoscope tip/Sheath tube	Working channel	Product no.
<b>Ureterorenoscope 5° 6/7.5 FR WL 430 mm</b> Atraumatically shaped tip	430 mm	599 mm	5°	6/7.5 Fr	1 x 4 or (2 x 2.2) Fr	<b>8702.524</b>
<b>Ureterorenoscope 12° 8/9.8 FR WL 430 mm</b> Atraumatically shaped tip	430 mm	599 mm	12°	8/9 Fr	1 x 5 or (2 x 3) Fr	<b>8703.524</b>
<b>Ureterorenoscope 12° 8.5/11.5 FR WL 430 mm</b> Atraumatically shaped tip	430 mm	599 mm	12°	8.5/11.5 Fr	1 x 6 or (2 x 4) Fr	<b>8704.524</b>

Recommended accessories		Product no.
<b>Handle for E-Line ureterorenoscopes</b>		<b>8702.261</b>
<b>Guide element for ureterorenoscope for LITHOCLAST handpieces</b>		<b>8702.251</b>
for inserting auxiliary instruments of 1–6 FR: <b>universal sealing valve 1–6 FR, sterile (PU = 5 PCS)</b>		<b>4712348</b>
<b>Membrane holder standard</b>		<b>15256.393</b>
<b>Membrane holder with Luer connection</b>		<b>15256.456</b>
<b>Seal Ø 7.5 mm (PU = 10 pcs)</b>		<b>89.101</b>
<b>Perforated basket, upper urinary tract 1 with small part basket</b>		Internal dimensions (W x H x D): 619 x 65 x 124 mm External dimensions (W x H x D): 635 x 75 x 132 mm <b>38003</b>
<b>Marking pen, black</b>		<b>38201.948</b>
<b>Fiber light cable bndl</b> consisting of: Fiber light cable (80662523), projector-side adapter (8095.07), and endoscope-side adapter (809509)		Ø 2.5 mm, 2.3 m long <b>806625231</b>
<b>Auxiliary instruments</b>		see URO119

E-line

FIBER URETERORENOSCOPE  
WITH LATERAL EYEPIECE

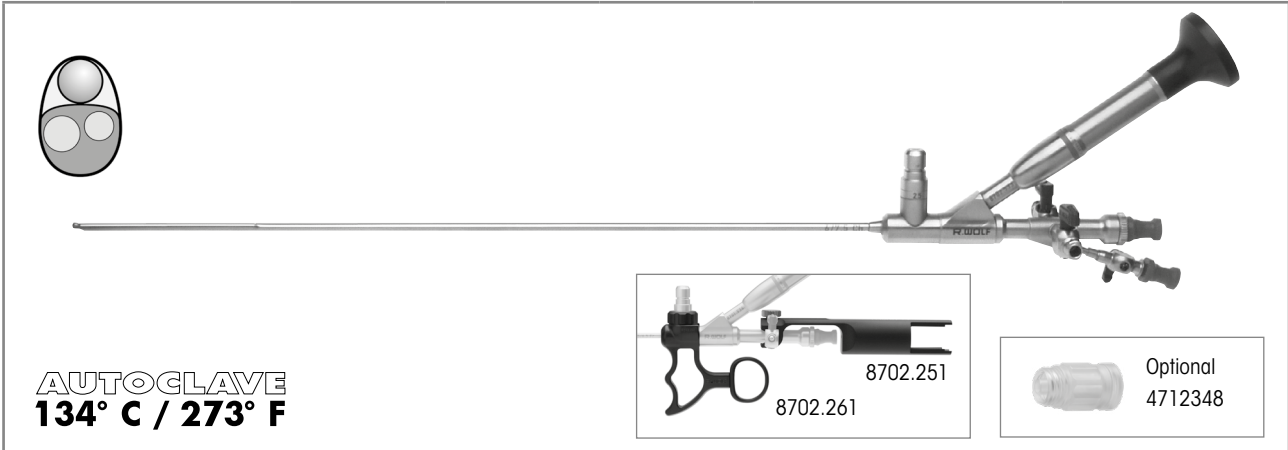

	WL	TL	Direction of view	Endoscope tip / Sheath tube	Working channel	Product no.
<b>Ureterorenoscope 5°</b> <b>6/7.5 FR WL 430 mm</b> Atraumatically shaped tip	430 mm	563 mm	5°	6/7.5 Fr	1 x 4 Fr or 2 x 2.2 Fr	<b>8702.534</b>
<b>Ureterorenoscope 12°</b> <b>8/9.8 FR WL 430 mm</b> Atraumatically shaped tip	430 mm	563 mm	12°	8/9.8 Fr	1 x 5 Fr or 2 x 3 Fr	<b>8703.534</b>

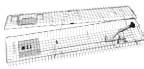
Recommended accessories		Product no.
<b>Handle for E-Line ureterorenoscopes</b>		<b>8702.261</b>
<b>Guide element for ureterorenoscope for LITHOCLAST handpieces</b>		<b>8702.251</b>
for inserting auxiliary instruments of 1–6 FR: <b>universal sealing valve 1–6 FR</b> , sterile (PU = 5 PCS)		<b>4712348</b>
<b>Membrane holder standard</b>		<b>15256.393</b>
<b>Membrane holder with Luer</b>		<b>15256.456</b>
<b>Seal Ø 7.5 mm</b> (PU = 10 pcs)		<b>89.101</b>
<b>Perforated basket, upper urinary tract 1</b> with small part basket		Internal dimensions (W x H x D): 619 x 65 x 124 mm External dimensions (W x H x D): 635 x 75 x 132 mm <b>38003</b>
<b>Marking pen, black</b>		<b>38201.948</b>
<b>Fiber light cable bndl</b> consisting of: Fiber light cable (80662523), projector-side adapter (8095.07), and endoscope-side adapter (809509)		Ø 2.5 mm, 2.3 m long <b>806625231</b>
<b>Auxiliary instruments</b>		<b>see URO119</b>

E-line

# CONTINUOUS IRRIGATION URETERORENOSCOPE WITH STRAIGHT EYEPIECE

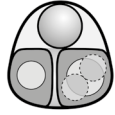

**AUTOCLAVE**  
**134° C / 273° F**

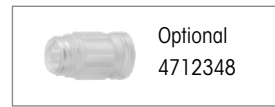

	WL	TL	Direction of view	Endoscope tip / Sheath tube	Working channel	Product no.
<b>Ureterorenoscope 5°</b> <b>6.5/8.5 FR WL 430 mm</b> Atraumatically shaped tip	430 mm	572 mm	5°	6.5 / 8.5 Fr	Working channel 1: 1 x 4 (2 x 2.2) Fr Working channel 2: 2.4 Fr	<b>8708.518</b>

Recommended accessories		Product no.
<b>Handle for E-Line ureterorenoscopes</b>		<b>8702.261</b>
for inserting auxiliary instruments of 1–6 FR: <b>universal sealing valve 1–6 FR</b> , sterile (PU = 5 PCS)		<b>4712348</b>
<b>Perforated basket, upper urinary tract 1</b> with small part basket	 Internal dimensions (W x H x D): 619 x 65 x 124 mm External dimensions (W x H x D): 635 x 75 x 132 mm	<b>38003</b>
<b>Marking pen, black</b>		<b>38201.948</b>
<b>Fiber light cable bndl</b> consisting of: Fiber light cable (80662523), projector-side adapter (8095.07), and endoscope-side adapter (809509)		Ø 2.5 mm, 2.3 m long <b>806625231</b>
<b>Auxiliary instruments</b>		see URO119

IX23 || Subject to modifications. Please note that some products may not be available in all countries. Please always take note of the information that is provided with the product. For more detailed information, please consult with your contact partner or directly with Richard Wolf GmbH.

E-line

# CONTINUOUS IRRIGATION URETERORENOSCOPE

WITH LATERAL EYEPIECE

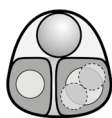

**AUTOCLAVE**  
**134° C / 273° F**

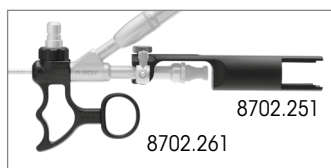

	WL	TL	Direction of view	Endoscope tip/Sheath tube	Working channel	Product no.
<b>Ureterorenoscope 5°</b> <b>6.5/8.5 FR WL 430 mm</b> Atraumatically shaped tip	430 mm	563 mm	5°	6.5/8.5 Fr	1 x 4.2 Fr and 2 x 2.4 Fr	<b>8708.534</b>
<b>Ureterorenoscope 12°</b> <b>8/9.8 FR WL 430 mm</b> Atraumatically shaped tip	430 mm	563 mm	12°	8/9.8 Fr	1 x 5 or (2 x 3) Fr	<b>8703.534</b>

Recommended accessories		Product no.
Handle for E-Line ureterorenoscopes		<b>8702.261</b>
Guide element for ureterorenoscope for LITHOCLAST handpieces		<b>8702.251</b>
for inserting auxiliary instruments of 1–6 FR: <b>universal sealing valve 1–6 FR</b> , sterile (PU = 5 PCS)		<b>4712348</b>
Membrane holder standard		<b>15256.393</b>
Membrane holder with Luer connection		<b>15256.456</b>
Seal Ø 7.5 mm (PU = 10 pcs)		<b>89.101</b>
<b>Perforated basket, upper urinary tract 1</b> with small part basket		Internal dimensions (W x H x D): 619 x 65 x 124 mm External dimensions (W x H x D): 635 x 75 x 132 mm <b>38003</b>
Marking pen, black		<b>38201.948</b>
<b>Fiber light cable bndl</b> consisting of: Fiber light cable (80662523), projector-side adapter (8095.07), and endoscope-side adapter (809509)		Ø 2.5 mm, 2.3 m long <b>806625231</b>
Auxiliary instruments		<b>see URO119</b>

IX23 | Subject to modifications. Please note that some products may not be available in all countries. Please always take note of the information that is provided with the product. For more detailed information, please consult with your contact partner or directly with Richard Wolf GmbH.







FIBER URETERORENOSCOPES

2.1

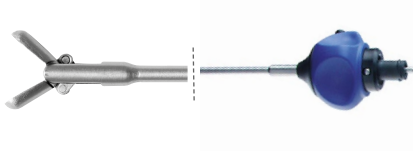
# FORCEPS AND SCISSORS

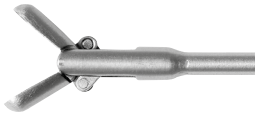
## SMALL MODULAR SYSTEM **HySafe**

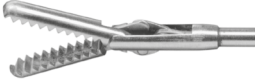
360° ROTATABLE, CAN BE FLUSHED THROUGH, EASY-CLICK

Grasping forceps jaw insert with sheath				Handle with overload protection	Complete instrument
					<ul style="list-style-type: none"> <li>• Jaw section</li> <li>• Handle</li> </ul>
	Product no.	Fr	WL	8083.001	Product no.
<b>Biopsy forceps bndl</b> 	8952.6008	5	550 mm	•	<b>8952.6002</b>
<b>Grasping forceps bndl with mouse tooth</b> 	8952.6118	4	550 mm	•	<b>8952.6112</b>
	8959.6218	5	425 mm	•	<b>8959.6212</b>
	8952.6218	5	550 mm	•	<b>8952.6212</b>
<b>Grasping forceps bndl with pike-mouth jaws, long</b> 	8959.6808	5	425 mm	•	<b>8959.6802</b>
	8954.6808	5	550 mm	•	<b>8954.6802</b>
<b>Grasping forceps bndl with pike-mouth jaws, short</b> 	8952.6508	5	550 mm	•	<b>8952.6502</b>

IX23 || Subject to modifications. Please note that some products may not be available in all countries. Please always take note of the information that is provided with the product. For more detailed information, please consult with your contact partner or directly with Richard Wolf GmbH.

**THE VIPER**

**FLEXIBLE FIBER URETERORENOSCOPES  
270°**

FLEXIBLE FIBER URS 270°  
  
2.2

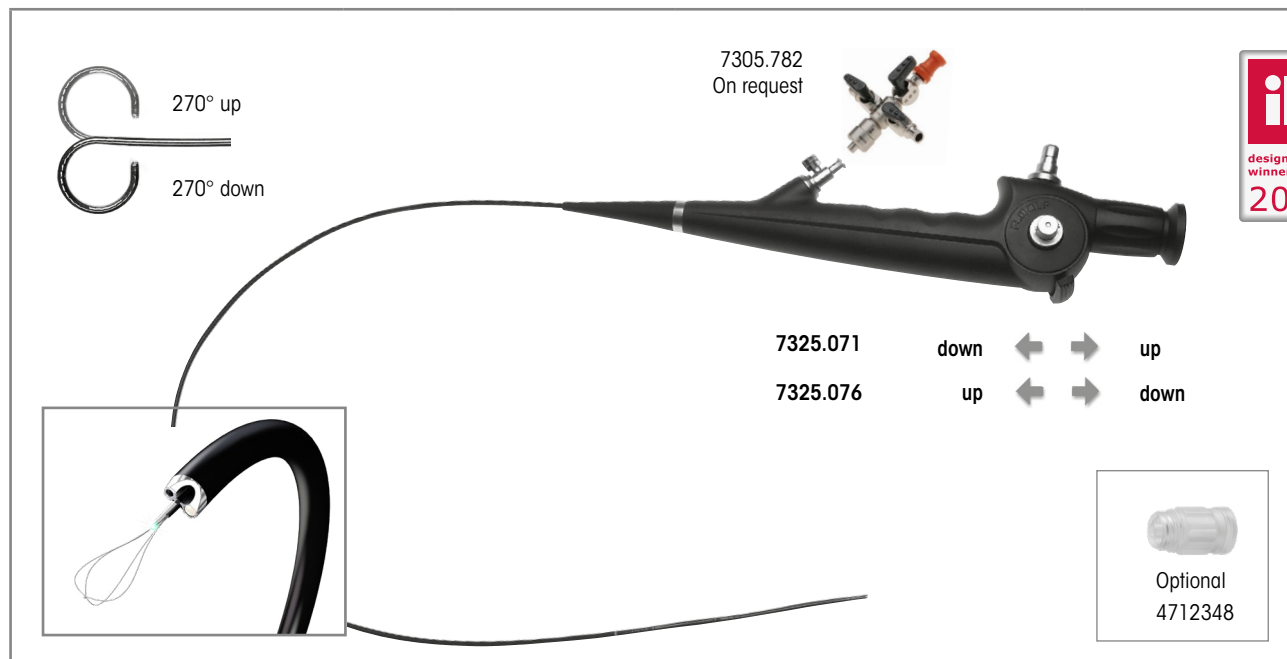

	Outer Ø	Working and laser fiber channel Ø	WL/TL	Control lever in distal direction – articulation downward	Control lever in distal direction – articulation upward	Product no.
<b>Fiber ureterorenoscope 9.6 FR WL 680 mm</b> Slanted distal tip Articulation +270°/-270° Direction of view 0°, angle of view 85°	9.6 Fr	2x 3.6 Fr	WL 680 mm	•		<b>7325.071</b>
			TL 1005 mm		•	<b>7325.076</b>
Also:						
<b>Pressure equalization valve</b>						<b>163.904</b>
<b>Leakage tester for flex. endoscopes</b>						<b>163.903</b>
<b>Adapter</b>						<b>163914</b>
<b>Clamping element, orange (20 PCS)</b>						<b>15394144</b>
<b>Cleaning brush Ø 2 mm, TL 1,200 mm (PU = 10 PCS)</b>						<b>7990001</b>
<b>Recommended accessories</b>						<b>Product no.</b>
<b>Fiber light cable bndl</b> consisting of: Fiber light cable Ø 2.5 mm, TL 2.3 m (80662523), projector-side adapter (8095.07), and endoscope-side adapter (809509)	Ø 2.5 mm, 2.3 m long				<b>806625231</b>	
<b>Perforated basket for flexible endoscopes</b> Also: <b>fixing ring Ø 50.39 mm</b>	(W x H x D): 448 x 106 x 288 mm				<b>33016</b>	
					<b>643301261</b>	
<b>Auxiliary instruments</b>						<b>see URO121</b>





IX23 || Subject to modifications. Please note that some products may not be available in all countries. Please always take note of the information that is provided with the product. For more detailed information, please consult with your contact partner or directly with Richard Wolf GmbH.















## FLEXIBLE FIBER URETERORENOSCOPES

### TECHNICAL DATA/ACCESSORIES AND AUXILIARY INSTRUMENTS

Fiber ureterorenoscope 9.6 FR WL 680 mm	7325.071/7325.076
Distal tip	Slanted distal tip 6 Fr
Sheath diameter	9.6 Fr
Number of working channels	2
Working/irrigation channel diameter	3.6 Fr
Articulation	270° upward, 270° downward
Working length	680 mm
Direction of view	0°
Angle of view	85°
Eyepiece	Adjustment eyepiece with diopter adjustment
Control lever	with position catch at 0° when instrument tip is extended and brake mechanism for locking

Accessories and auxiliary instruments		Product no.
	<b>Adapter</b> with 2 irrigation valves and 1 instrument port, quick-release mechanism	<b>7305.782</b>
	Also: <b>Luer sealing cap</b>	<b>15023205</b>
	<b>RIWO rubber cap, capacity 0.8 mm</b>	<b>88.01</b>
	<b>Universal sealing valve 1–6 FR</b> for inserting auxiliary instruments of 1–6 Fr	<b>4712348</b>
	<b>Adapter</b> for machine leakage tests	<b>163.905</b>

**FLEXIBLE FIBER URETERORENOSCOPES**
**ACCESSORIES AND AUXILIARY INSTRUMENTS**

		Fr	WL	TL	Product no.
	Flex. grasping forceps 3 FR WL 530 mm	3	530 mm	665 mm	<b>828.605</b>
	Flex. grasping forceps 5 FR WL 550 mm	5	550 mm	720 mm	<b>828.051</b>
 Fine tooththing	Flex. grasping forceps 3 FR WL 920 mm	3	920 mm	1,050 mm	<b>828.651</b>
	Flex. biopsy forceps 5 FR WL 550 mm	5	550 mm	720 mm	<b>829.051</b>
	Flex. biopsy forceps 3 FR WL 530 mm	3	530 mm	665 mm	<b>829.603</b>
	Flex. biopsy forceps Ø 3 FR WL 920 mm	3	920 mm	1,055 mm	<b>829.601</b>
	Flex. biopsy forceps 4 FR WL 600 mm	4	600 mm	730 mm	<b>8734.606</b>
 Pike-mouth jaws	Flex. grasping forceps 4 FR WL 600 mm	4	600 mm	750 mm	<b>8734.656</b>
 Mouse tooth	Flex. grasping forceps 4 FR WL 600 mm	4	600 mm	750 mm	<b>8734.686</b>
	Flex. grasping forceps 5 FR WL 550 mm	5	550 mm	700 mm	<b>8735.685</b>
	Flex. grasping forceps 3.5 FR WL 550 mm, fine tooththing	3.5	550 mm	700 mm	<b>8953.60</b>
	Coag. electrode mono 5 FR WL 600 mm	5	600 mm	-	<b>8599.80</b>
	Coag. electrode mono 3 FR WL 580 mm	3	580 mm	-	<b>823.031</b>
	Hook electrode mono 2.4 FR WL 600 mm	2.4	600 mm	-	<b>823.221</b>



## FLEXIBLE FIBER 2-CHANNEL CONTINUOUS IRRIGATION LASER URETERORENOSCOPES

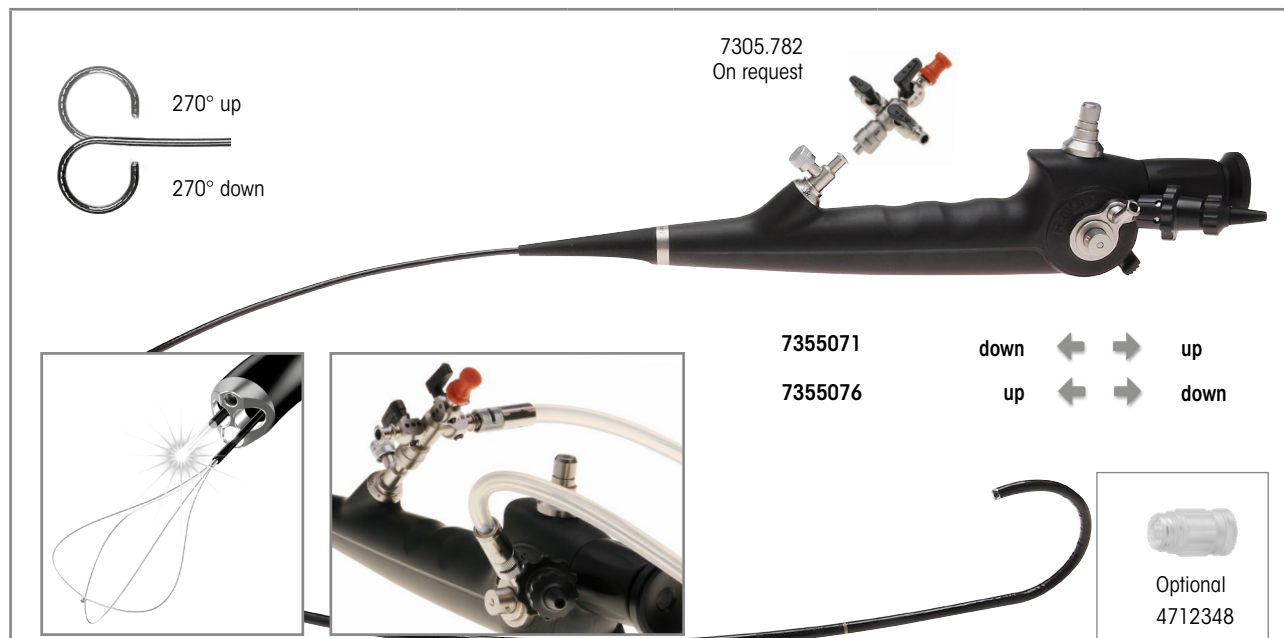

	Outer Ø	Working and laser fiber channel Ø	WL/TL	Control lever in distal direction – articulation downward	Control lever in distal direction – articulation upward	Product no.
<b>Fiber ureterorenoscope 9.9 FR WL 680 mm</b> Slanted distal tip Articulation +270°/-270° Direction of view 0°, angle of view 85°	9.9 Fr	2x 3.3 Fr	WL 680 mm	•		<b>7326071</b>
			TL 1,010 mm		•	<b>7326076</b>
<b>Fiber ureterorenoscope bndl</b> consisting of: Fiber ureterorenoscope 9.9 FR WL 680 mm (7326071), pressure equalization valve (163.904), leakage tester for flex. endoscopes (163.903), adapter (163914), clamping element (15394144), and cleaning brush Ø 2 mm, TL 1,200 mm (PU = 10 PCS) (7990001)				•		<b>732607111</b>
<b>Fiber ureterorenoscope bndl</b> consisting of: Fiber ureterorenoscope 9.9 FR WL 680 mm (7326076), pressure equalization valve (163.904), leakage tester for flex. endoscopes (163.903), adapter (163914), clamping element (15394144), and cleaning brush Ø 2 mm, TL 1,200 mm (PU = 10 PCS) (7990001)					•	<b>732607611</b>
<b>Recommended accessories</b>						<b>Product no.</b>
<b>Fiber light cable bndl</b> consisting of: Fiber light cable Ø 2.5 mm, TL 2.3 m (80662523), projector-side adapter (8095.07), and endoscope-side adapter (809509)				Ø 2.5 mm, 2.3 m long		<b>806625231</b>
<b>Perforated basket for flexible endoscopes</b>  Also: <b>fixing ring Ø 50.39 mm</b>				(W x H x D): 448 x 106 x 288 mm		<b>33016</b>
						<b>643301261</b>
for auxiliary instruments, see URO125						

IX23 || Subject to modifications. Please note that some products may not be available in all countries. Please always take note of the information that is provided with the product. For more detailed information, please consult with your contact partner or directly with Richard Wolf GmbH.



## FLEXIBLE FIBER 2-CHANNEL CONTINUOUS IRRIGATION LASER URETERORENOSCOPES

### TECHNICAL DATA







Fiber ureterorenoscope 9.9 FR WL 680 mm	7326071/7326076
Distal tip	Slanted distal tip 6 Fr
Sheath diameter	9.9 Fr
Number of working channels	2
Working/irrigation channel diameter	3.3 Fr
Laser/irrigation channel diameter	3.3 Fr
Articulation	270° upward, 270° downward
Working length	680 mm
Direction of view	0°
Angle of view	85°
Eyepiece	Adjustment eyepiece with diopter adjustment
Control lever	with position catch at 0° when instrument tip is extended and brake mechanism for locking

ENDOCAM LOGIC HD equipment		Product no.
	<p><b>ENDOCAM Logic HD Lite controller bndl</b></p> <p>consisting of:</p> <ul style="list-style-type: none"> <li>ENDOCAM Logic HD Lite camera control unit (5525201)</li> <li>Handheld remote control USB (5525401)</li> <li>USB flash memory 8 GB (56540028)</li> <li>HDMI/DVI-D cable, lockable, 3.0 m (103843)</li> <li>Power cable (2440.03)</li> <li>5525 DVD license open-source software (64360816)</li> </ul>	<p><b>55252011</b></p>

IX23 || Subject to modifications. Please note that some products may not be available in all countries. Please always take note of the information that is provided with the product. For more detailed information, please consult with your contact partner or directly with Richard Wolf GmbH.



## FLEXIBLE FIBER 2-CHANNEL CONTINUOUS IRRIGATION LASER URETERORENOSCOPES ACCESSORIES AND AUXILIARY INSTRUMENTS

		Outer Ø	WL	Product no.
	<b>Flex. biopsy forceps Ø 3 Fr WL 920 mm</b>	3 Fr	920 mm	<b>829.601</b>
	<b>Flex. grasping forceps 3 Fr WL 920 mm</b>	3 Fr	920 mm	<b>828.651</b>
	<b>Adapter</b> with 2 irrigation valves and 1 instrument port, quick-release mechanism			<b>7305.782</b>
	Also: <b>Luer sealing cap</b>			<b>15023205</b>
	<b>RIWO rubber cap, capacity 0.8 mm</b>			<b>88.01</b>
	<b>Universal sealing valve 1–6 FR</b> for inserting auxiliary instruments of 1–6 Fr			<b>4712348</b>
	<b>Adapter</b> for machine leakage tests			<b>163.905</b>
	<b>Laser adjustment unit bndl</b>			<b>15369108</b>
	Also: <b>clamping element, orange (20 pcs)</b>			<b>15394144</b>

IX23 || Subject to modifications. Please note that some products may not be available in all countries. Please always take note of the information that is provided with the product. For more detailed information, please consult with your contact partner or directly with Richard Wolf GmbH.

**FLEXIBLE 1-CHANNEL SENSOR URETERORENOSCOPES**  
FOR ENDOCAM **Logic 4K** CONTROLLER

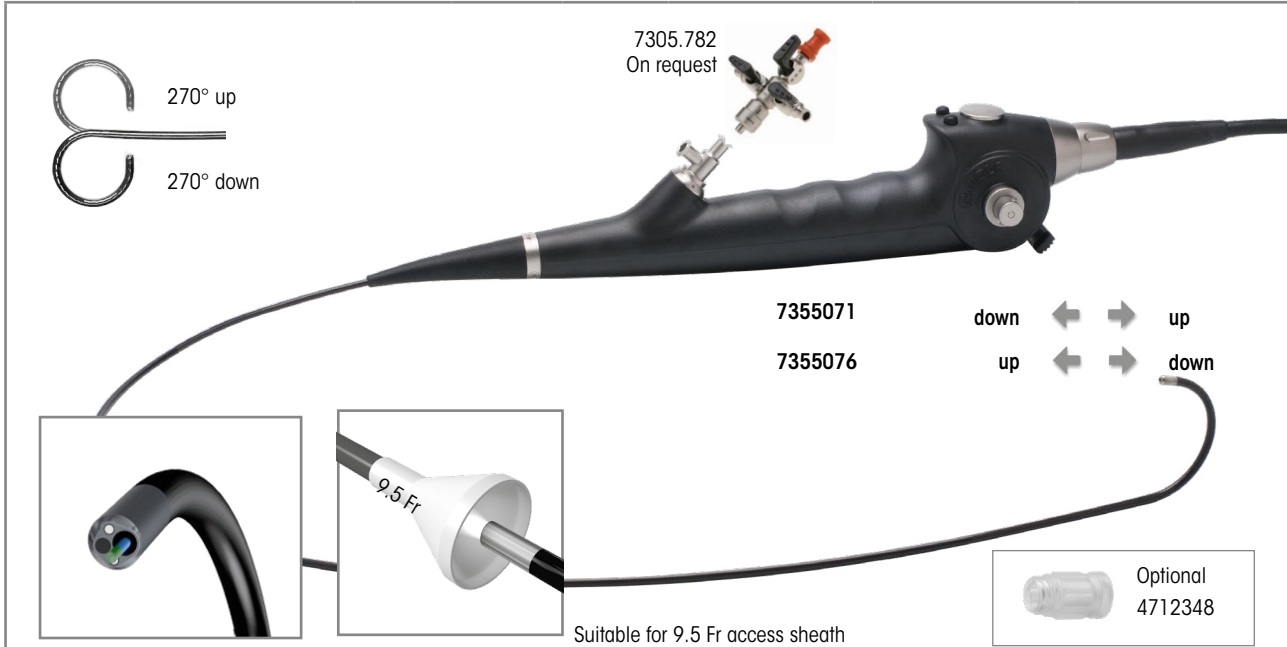

	Outer Ø	Working/irrigation channel	WL	Control lever in distal direction – articulation downward	Control lever in distal direction – articulation upward	Product no.
<b>Sensor ureterorenoscope 8.7 FR WL 680 mm</b> Slanted distal tip Articulation +270°/-270° Direction of view 6.5°, angle of view 90°	8.7 Fr	3.6 Fr	680 mm	•		<b>7355071</b>
					•	<b>7355076</b>
<b>Sensor ureterorenoscope bndl</b> consisting of: Sensor ureterorenoscope 8.7 FR WL 680 mm (7355071), pressure equalization valve (163.904), leakage tester for flex. endoscopes (163.903), and cleaning brush Ø 2 mm, TL 1,200 mm (PU = 10 PCS) (7990001)				•		<b>73550712</b>
<b>Sensor ureterorenoscope bndl</b> consisting of: Sensor ureterorenoscope 8.7 FR WL 680 mm (7355076), pressure equalization valve (163.904), leakage tester for flex. endoscopes (163.903), and cleaning brush Ø 2 mm, TL 1,200 mm (PU = 10 PCS) (7990001)					•	<b>73550762</b>

Recommended accessories		Product no.
<b>Fiber light cable bndl</b> consisting of: Fiber light cable Ø 2.5 mm, TL 2.3 m (80662523), projector-side adapter (8095.07), and endoscope-side adapter (809509)	Ø 2.5 mm, 2.3 m long	<b>806625231</b>
<b>Perforated basket for flexible endoscopes</b>  Also: <b>fixing ring Ø 50.39 mm</b>	(W x H x D): 448 x 106 x 288 mm	<b>33016</b>
		<b>643301261</b>
for auxiliary instruments, see URO128		

## FLEXIBLE 1-CHANNEL SENSOR URETERORENOSCOPES

### TECHNICAL DATA

Sensor ureterorenoscope 8.7 FR WL 680 mm	7355071/7355076
Distal tip	Cylindrical, atraumatic, slanted distal stainless steel tip 6.6 Fr
Sheath diameter	8.7 Fr
Number of working channels	1
Working/irrigation channel diameter	3.6 Fr
Articulation	270° upward, 270° downward
Working length	680 mm
Angle of view	90°
Handle	Ergonomic handle design with axial cable outlet
Positioning of the working and irrigation channel in relation to the picture	At 6 o'clock
Endopicture	Square, 6x digital zoom; automatic white balance, light control, and focus
Compatible camera control unit	ENDOCAM Logic 4K ENDOCAM Logic HD

#### ENDOCAM LOGIC 4K – Video equipment

Product no.



#### ENDOCAM Logic 4K camera control unit bndl

consisting of:

ENDOCAM Logic 4K camera control unit (5525301)

Handheld remote control (5525401)

1x USB flash memory 32 GB (72321829)









1x HDMI/HDMI cable, lockable, 3.0 m (103847)

1x power cable (2440.03)

**55253011**

## FLEXIBLE 1-CHANNEL SENSOR URETERORENOSCOPES

### ACCESSORIES AND AUXILIARY INSTRUMENTS

		Outer Ø	WL	Product no.
	Flex. biopsy forceps Ø 3 Fr WL 920 mm	3 Fr	920 mm	<b>829.601</b>
	Flex. grasping forceps 3 Fr WL 920 mm	3 Fr	920 mm	<b>828.651</b>
	Laser fiber Ø 365 µm, disposable	365 µm		<b>4875013650</b>
	Laser fiber Ø 550 µm, disposable	550 µm		<b>487501550</b>
	Laser fiber Ø 365 µm, reusable	365 µm		<b>875013650</b>
	Laser fiber Ø 550 µm, reusable	550 µm		<b>87501550</b>
	<b>Adapter</b> with 2 irrigation valves and 1 instrument port, quick-release mechanism			<b>7305.782</b>
	Also: <b>Luer sealing cap</b>			<b>15023205</b>
	<b>RIWO rubber cap, capacity 0.8 mm</b>			<b>88.01</b>
	<b>Universal sealing valve 1–6 FR</b> for inserting auxiliary instruments of 1–6 Fr			<b>4712348</b>
	<b>Adapter</b> for machine leakage tests			<b>163.905</b>



## FLEXIBLE 1-CHANNEL SENSOR URETERORENOSCOPES FOR ENDOCAM Flex HD CONTROLLER

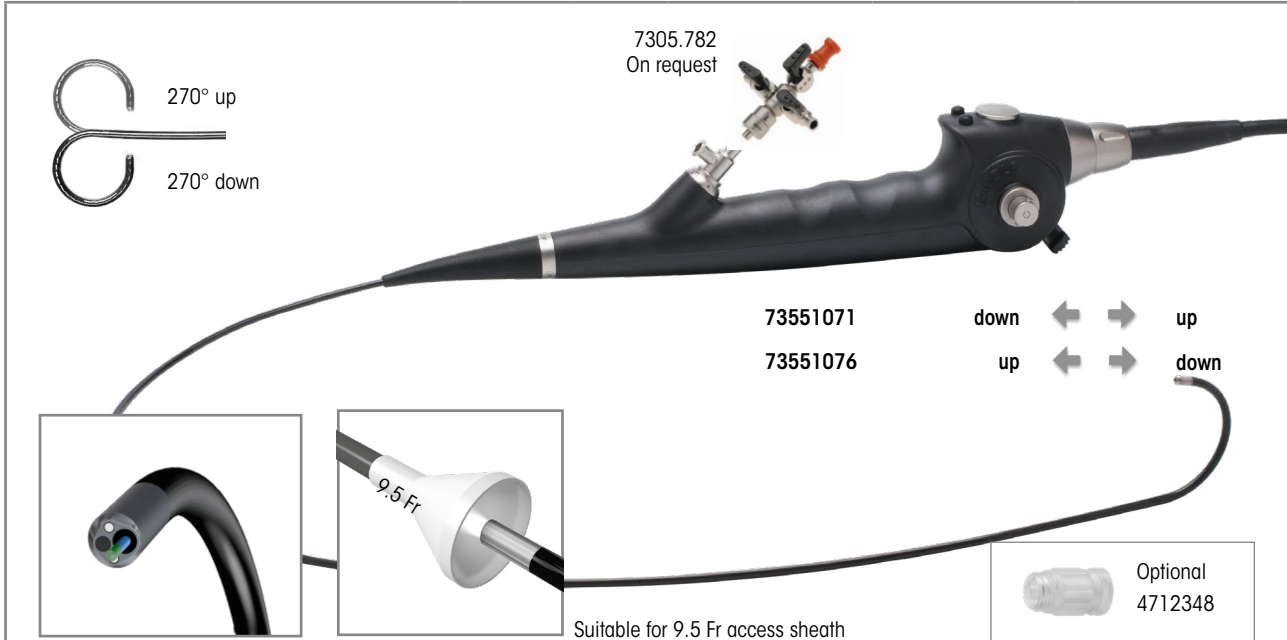

	Outer Ø	Working / irrigation channel	WL	Control lever in distal direction – articulation downward	Control lever in distal direction – articulation upward	Product no.
<b>Sensor ureterorenoscope 8.7 FR WL 680 mm</b> Slanted distal tip Articulation +270°/-270° Direction of view 6.5°, angle of view 90°	8.7 Fr	3.6 Fr	680 mm	•		<b>73551071</b>
					•	<b>73551076</b>
<b>Sensor ureterorenoscope bndl</b> consisting of: Sensor ureterorenoscope 8.7 FR WL 680 mm (73551071), pressure equalization valve (163.904), leakage tester for flex. endoscopes (163.903), and cleaning brush Ø 2 mm, TL 1,200 mm (PU = 10 PCS) (7990001)				•		<b>735510712</b>
<b>Sensor ureterorenoscope bndl</b> consisting of: Sensor ureterorenoscope 8.7 FR WL 680 mm (73551076), pressure equalization valve (163.904), leakage tester for flex. endoscopes (163.903), and cleaning brush Ø 2 mm, TL 1,200 mm (PU = 10 PCS) (7990001)					•	<b>735510762</b>
<b>Recommended accessories</b>						<b>Product no.</b>
<b>Fiber light cable bndl</b> consisting of: Fiber light cable Ø 2.5 mm, TL 2.3 m (80662523), projector-side adapter (8095.07), and endoscope-side adapter (809509)				Ø 2.5 mm, 2.3 m long		<b>806625231</b>
<b>Perforated basket for flexible endoscopes</b>  Also: <b>fixing ring Ø 50.39 mm</b>				(W x H x D): 448 x 106 x 288 mm		<b>33016</b>
						<b>643301261</b>
for auxiliary instruments, see URO131						

FLEXIBLE 1-CHANNEL SENSOR URS

2.4









IX23 || Subject to modifications. Please note that some products may not be available in all countries. Please always take note of the information that is provided with the product. For more detailed information, please consult with your contact partner or directly with Richard Wolf GmbH.

## FLEXIBLE 1-CHANNEL SENSOR URETERORENOSCOPES

### TECHNICAL DATA

Sensor ureterorenoscope 8.7 FR WL 680 mm	73551071/73551076
Distal tip	Cylindrical, atraumatic, slanted distal stainless steel tip 6.6 Fr
Sheath diameter	8.7 Fr
Number of working channels	1
Working/irrigation channel diameter	3.6 Fr
Articulation	270° upward, 270° downward
Working length	680 mm
Angle of view	90°
Handle	Integrated LED illumination, ergonomic handle design with axial camera cable
Positioning of the working and irrigation channel in relation to the picture	At 9 o'clock
Endopicture	Square, 1.5x zoom, detail enhancement, automatic white balance and brightness control, no focusing necessary
Compatible camera control unit	ENDOCAM Logic 4K ENDOCAM Logic HD

## FLEXIBLE 1-CHANNEL SENSOR URETERORENOSCOPES ACCESSORIES AND AUXILIARY INSTRUMENTS

		Outer Ø	WL	Product no.
	<b>Flex. biopsy forceps Ø 3 Fr WL 920 mm</b>	3 Fr	920 mm	<b>829.601</b>
	<b>Flex. grasping forceps 3 Fr WL 920 mm</b>	3 Fr	920 mm	<b>828.651</b>
	<b>Laser fiber Ø 365 µm, disposable</b>	200 µm		<b>487501200</b>
	<b>Laser fiber Ø 550 µm, disposable</b>	272 µm		<b>487501272</b>
	<b>Laser fiber Ø 365 µm, reusable</b>	200 µm		<b>87501200</b>
	<b>Laser fiber Ø 550 µm, reusable</b>	272 µm		<b>87501272</b>
	<b>Adapter</b> with 2 irrigation valves and 1 instrument port, quick-release mechanism			<b>7305.782</b>
	Also: <b>Luer sealing cap</b>			<b>15023205</b>
	<b>RIWO rubber cap, capacity 0.8 mm</b>			<b>88.01</b>
	<b>Universal sealing valve 1–6 FR</b> for inserting auxiliary instruments of 1–6 Fr			<b>4712348</b>
	<b>Adapter</b> for machine leakage tests			<b>163.905</b>

**FLEXIBLE 2-CHANNEL SENSOR URETERORENOSCOPES**  
FOR ENDOCAM **Logic 4K** CONTROLLER

FLEXIBLE 2-CHANNEL SENSOR URS

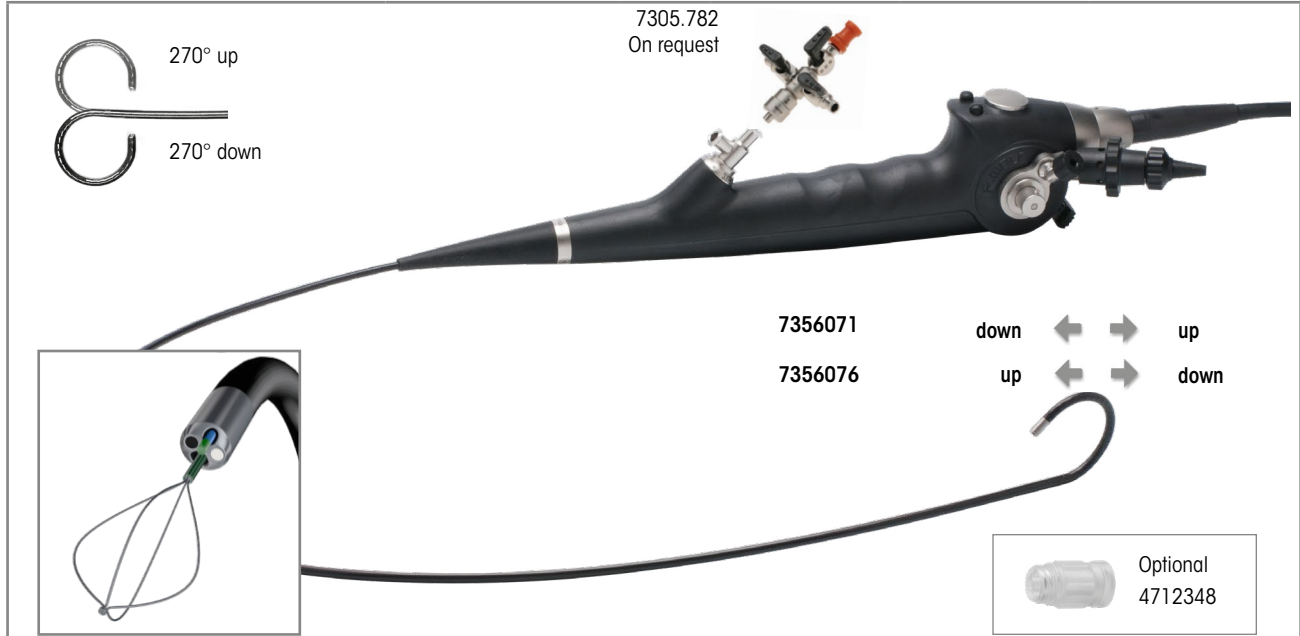

	Outer Ø	Working/laser channel	WL	Control lever in distal direction – articulation downward	Control lever in distal direction – articulation upward	Product no.
<b>Sensor ureterorenoscope 9.9 FR WL 680 mm</b> Slanted distal tip Articulation +270°/-270° Direction of view 0°, angle of view 120°	9.9 Fr	Working channel 3.6 Fr laser channel 2.4 Fr	680 mm	•		<b>7356071</b>
					•	<b>7356076</b>
<b>Sensor ureterorenoscope bndl</b> consisting of: Sensor ureterorenoscope 9.9 FR WL 680 mm (7356071), pressure equalization valve (163.904), leakage tester for flex. endoscopes (163.903), adapter (163914), cleaning brush Ø 2 mm, TL 1,200 mm (PU = 10 PCS) (7990001), cleaning brush Ø 0.85 mm, TL 1,200 mm (PU = 10 PCS) (7990003), and clamping element, orange (20 pcs) (15394144)				•		<b>73560712</b>
<b>Sensor ureterorenoscope bndl</b> consisting of: Sensor ureterorenoscope 9.9 FR WL 680 mm (7356076), pressure equalization valve (163.904), leakage tester for flex. endoscopes (163.903), adapter (163914), cleaning brush Ø 2 mm, TL 1,200 mm (PU = 10 PCS) (7990001), cleaning brush Ø 0.85 mm, TL 1,200 mm (PU = 10 PCS) (7990003), and clamping element, orange (20 pcs) (15394144)					•	<b>73560762</b>
<b>Recommended accessories</b>						<b>Product no.</b>
<b>Fiber light cable bndl</b> consisting of: Fiber light cable Ø 2.5 mm, TL 2.3 m (80662523), projector-side adapter (8095.07), and endoscope-side adapter (809509)				Ø 2.5 mm, 2.3 m long		<b>806625231</b>
<b>Perforated basket for flexible endoscopes</b> Also: <b>fixing ring Ø 50.39 mm</b>				(W x H x D): 448 x 106 x 288 mm		<b>33016</b>
for auxiliary instruments, see URO134						<b>643301261</b>

IX23 | Subject to modifications. Please note that some products may not be available in all countries. Please always take note of the information that is provided with the product. For more detailed information, please consult with your contact partner or directly with Richard Wolf GmbH.

## FLEXIBLE 2-CHANNEL SENSOR URETERORENOSCOPES









### TECHNICAL DATA

Sensor ureterorenoscope 9.9 FR WL 680 mm	7356071/7356076
Distal tip	Cylindrical, atraumatic, slanted distal stainless steel tip 5.2 Fr
Sheath diameter	9.9 Fr
Number of working channels	2
Working/irrigation channel diameter	3.6 Fr
Laser/irrigation channel diameter	2.4 Fr
Articulation	270° upward, 270° downward
Working length	680 mm
Angle of view	90°
Handle	Ergonomic handle design with axial cable outlet
Positioning of the working and irrigation channel in relation to the picture	At 6 o'clock
Positioning of the laser and irrigation channel in relation to the picture	At 9 o'clock
Endopicture	Square, 6x digital zoom; automatic white balance, light control, and focus
Compatible camera control unit	ENDOCAM Logic 4K ENDOCAM Logic HD

ENDOCAM LOGIC 4K – Video equipment	Product no.
 <p><b>ENDOCAM Logic 4K camera control unit bndl</b> consisting of: ENDOCAM Logic 4K camera control unit (5525301) Handheld remote control (5525401) 1x USB flash memory 32 GB (72321829) 1x HDMI/HDMI cable, lockable, 3.0 m (103847) 1x power cable (2440.03)</p>	<b>55253011</b>

## FLEXIBLE 2-CHANNEL SENSOR URETERORENOSCOPES

### ACCESSORIES AND AUXILIARY INSTRUMENTS

		Outer Ø	WL	Product no.
	Flex. biopsy forceps Ø 3 Fr WL 920 mm	3 Fr	920 mm	<b>829.601</b>
	Flex. grasping forceps 3 Fr WL 920 mm	3 Fr	920 mm	<b>828.651</b>
	<b>Adapter</b> with 2 irrigation valves and 1 instrument port, quick-release mechanism			<b>7305.782</b>
	Also: <b>Luer sealing cap</b>			<b>15023205</b>
	<b>RIWO rubber cap, capacity 0.8 mm</b>			<b>88.01</b>
	<b>Universal sealing valve 1–6 FR</b> for inserting auxiliary instruments of 1–6 Fr			<b>4712348</b>
	<b>Adapter</b> for machine leakage tests			<b>163.905</b>
	<b>Laser adjustment unit bndl</b>			<b>15369108</b>
	Also: <b>clamping element, orange (20 pcs)</b>			<b>15394144</b>

IX23 || Subject to modifications. Please note that some products may not be available in all countries. Please always take note of the information that is provided with the product. For more detailed information, please consult with your contact partner or directly with Richard Wolf GmbH.

**FLEXIBLE 2-CHANNEL SENSOR URETERORENOSCOPES**  
FOR ENDOCAM **Flex HD** CONTROLLER

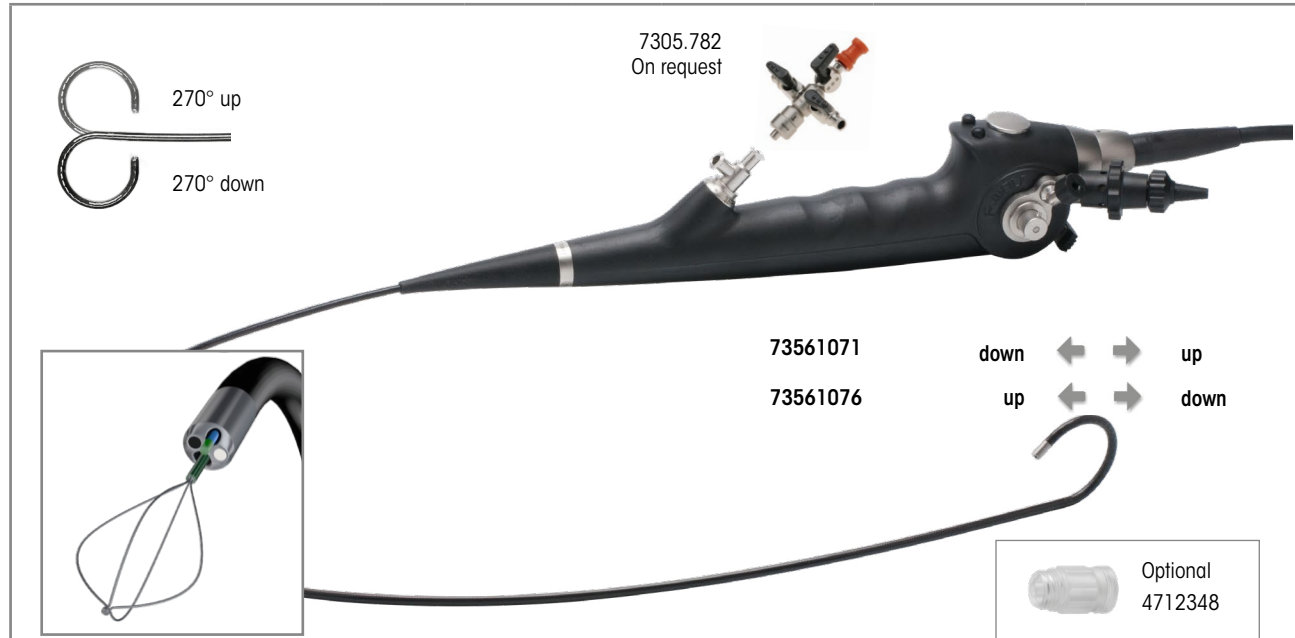

	Outer Ø	Working/Laser channel	WL	Control lever in distal direction – articulation downward	Control lever in distal direction – articulation upward	Product no.
<b>Sensor ureterorenoscope 9.9 FR WL 680 mm</b> Slanted distal tip Articulation +270°/-270° Direction of view 0°, angle of view 90°	9.9 Fr	Working channel 3.6 Fr Laser channel 2.4 Fr	680 mm	•		<b>73561071</b>
					•	<b>73561076</b>
<b>Sensor ureterorenoscope bndl</b> consisting of: Sensor ureterorenoscope 9.9 FR WL 680 mm (73561071), pressure equalization valve (163.904), leakage tester for flex. endoscopes (163.903), adapter (163914), cleaning brush Ø 2 mm, TL 1,200 mm (PU = 10 PCS) (7990001), cleaning brush Ø 0.85 mm, TL 1,200 mm (PU = 10 PCS) (7990003), and clamping element, orange (20 pcs) (15394144)				•		<b>735610712</b>
<b>Sensor ureterorenoscope bndl</b> consisting of: Sensor ureterorenoscope 9.9 FR WL 680 mm (73561076), pressure equalization valve (163.904), leakage tester for flex. endoscopes (163.903), adapter (163914), cleaning brush Ø 2 mm, TL 1,200 mm (PU = 10 PCS) (7990001), cleaning brush Ø 0.85 mm, TL 1,200 mm (PU = 10 PCS) (7990003), and clamping element, orange (20 pcs) (15394144)					•	<b>735610762</b>
<b>Recommended accessories</b>						<b>Product no.</b>
<b>Fiber light cable bndl</b> consisting of: Fiber light cable Ø 2.5 mm, TL 2.3 m (80662523), projector-side adapter (8095.07), and endoscope-side adapter (809509)				Ø 2.5 mm, 2.3 m long		<b>806625231</b>
<b>Perforated basket for flexible endoscopes</b> Also: <b>fixing ring Ø 50.39 mm</b>				(W x H x D): 448 x 106 x 288 mm		<b>33016</b>
						<b>643301261</b>
for auxiliary instruments, see URO137						

FLEXIBLE 2-CHANNEL SENSOR URS

2.5

IX23 || Subject to modifications. Please note that some products may not be available in all countries. Please always take note of the information that is provided with the product. For more detailed information, please consult with your contact partner or directly with Richard Wolf GmbH.









## FLEXIBLE 2-CHANNEL SENSOR URETERORENOSCOPES

### TECHNICAL DATA

Sensor ureterorenoscope 9.9 FR WL 680 mm	73561071/73561076
Distal tip	Cylindrical, atraumatic, slanted distal stainless steel tip 5.2 Fr
Sheath diameter	9.9 Fr
Number of working channels	2
Working/irrigation channel diameter	3.6 Fr
Laser/irrigation channel diameter	2.4 Fr
Articulation	270° upward, 270° downward
Working length	680 mm
Angle of view	90°
Handle	Integrated LED illumination, ergonomic handle design with axial camera cable
Positioning of the working and irrigation channel in relation to the picture	At 6 o'clock
Positioning of the laser and irrigation channel in relation to the picture	At 9 o'clock
Endopicture	Square, 1.5x zoom, detail enhancement, automatic white balance and brightness control, no focusing necessary
Compatible camera control unit	ENDOCAM Logic 4K ENDOCAM Logic HD



## FLEXIBLE 2-CHANNEL SENSOR URETERORENOSCOPES ACCESSORIES AND AUXILIARY INSTRUMENTS

		Outer Ø	WL	Product no.
	<b>Flex. biopsy forceps Ø 3 Fr WL 920 mm</b>	3 Fr	920 mm	<b>829.601</b>
	<b>Flex. grasping forceps 3 Fr WL 920 mm</b>	3 Fr	920 mm	<b>828.651</b>
	<b>Adapter</b> with 2 irrigation valves and 1 instrument port, quick-release mechanism			<b>7305.782</b>
	Also: <b>Luer sealing cap</b>			<b>15023205</b>
	<b>RIWO rubber cap, capacity 0.8 mm</b>			<b>88.01</b>
	<b>Universal sealing valve 1–6 FR</b> for inserting auxiliary instruments of 1–6 Fr			<b>4712348</b>
	<b>Adapter</b> for machine leakage tests			<b>163.905</b>
	<b>Laser adjustment unit bndl</b>			<b>15369108</b>
	Also: <b>clamping element, orange (20 pcs)</b>			<b>15394144</b>

RIWO   
**D-URS**

DISPOSABLE SENSOR URETERORENOSCOPE

DISPOSABLE SENSOR URS – RIWO D-URS



300° up  
300° down

 **reddot winner 2020**

	Fr	WL	Product no.
<b>Sensor ureterorenoscope 9 Fr WL 600 mm</b> (PU = 3 PCS)	9 Fr	600 mm	<b>473572076</b>

IX23 || Subject to modifications. Please note that some products may not be available in all countries. Please always take note of the information that is provided with the product. For more detailed information, please consult with your contact partner or directly with Richard Wolf GmbH.

**RIWO**   
**D-URS**

**TECHNICAL DATA**

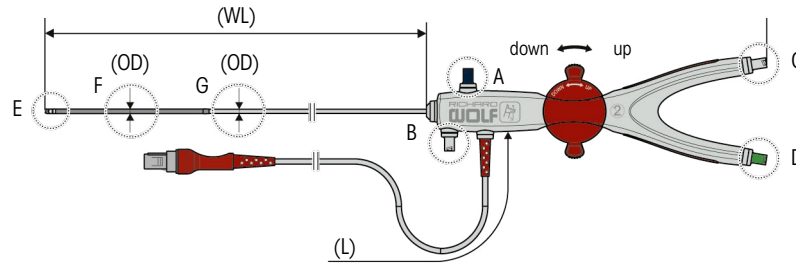
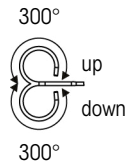

**Sensor ureterorenoscope 9 Fr WL 600 mm 473572076**

Working length (WL)	600 mm
Cable length (L)	2,500 mm
Outer diameter (OD) (flexible area) F	9 Fr
Outer diameter (OD) (semi-rigid area) G	8.1 Fr
Distal instrument tip E	6 Fr
Working channel (C)	3.6 Fr
Laser fiber channel (D)	1.65 Fr
Articulation	+/-300° (up/down)
Direction of view	0°
Angle of view	90°
Luer connection for inlet, color: blue A	Ø 3.0 mm
Luer connection for outlet, color: gray B	Ø 3.0 mm
Luer connection for working channel, color: gray C	Ø 3.0 mm
Luer connection for laser fiber channel, color: green D	Ø 3.0 mm
Operating conditions	Temperature: +10 °C to +40 °C, rel. humidity: 20 % to 75 %, atmospheric pressure: 700 hPa to 1,060 hPa
Storage conditions	Temperature: +5 °C to +30 °C, rel. humidity: 10 % to 70 %, atmospheric pressure: 700 hPa to 1,060 hPa

DISPOSABLE SENSOR URS – RIWO D-URS

2.6

IX23 || Subject to modifications. Please note that some products may not be available in all countries. Please always take note of the information that is provided with the product. For more detailed information, please consult with your contact partner or directly with Richard Wolf GmbH.

**RIWO D-URS**

**CAMERA CONTROL UNIT AND ACCESSORIES**



**Adapter for control unit 5525** ..... 5525410

The sensor ureterorenoscope is compatible with the following Richard Wolf camera control units\* using the adapter (5525410) for control unit 5525:

- 5525101 Logic HD camera control unit
- 2525301 Logic 4K camera control unit
- 5525201 Logic HD lite camera control unit

\* Software version V2.0.9 or higher







**ENDOCAM D camera control unit bndl** ..... 55221011

consisting of:

- 1x ENDOCAM D camera control unit ..... 5522101
  - 1x Vector Plus coax cable 3.00 m ..... DZGR-0300-SW-GN
  - 1x HDMI/DVI-D cable, lockable 3.0 m ..... 103843
  - 1x license for open-source software ..... 72321911
  - 1x power cable 3 m long ..... 2440.03
- (see rear for technical data)

Also:

**Handheld remote control USB** ..... 5525401

		Outer Ø	WL	Product no.
Flex. biopsy forceps Ø 3 Fr WL 920 mm		3 Fr	920 mm	<b>829.601</b>
Flex. grasping forceps 3 Fr WL 920 mm		3 Fr	920 mm	<b>828.651</b>
		Ø	L	Product no.
Power laser fiber Ø 200 µm, disposable		200 µm	3.0 m	<b>487502200</b>
Laser fiber Ø 200 µm, disposable		200 µm	3.0 m	<b>487501200</b>
Laser fiber Ø 272 µm, disposable		272 µm	3.0 m	<b>487501272</b>
These particular laser fibers are compatible with the Richard Wolf MegaPulse 30 <sup>+</sup> and MegaPulse 70 <sup>+</sup> lasers.				
				Product no.
<b>Universal sealing valve 1–6 FR</b> (PU = 5 PCS) sterile, for single use for inserting auxiliary instruments 1–6 Fr				<b>4712348</b>
<b>Luer sealing cap</b>				<b>15023205</b>
<b>RIWO rubber cap, capacity 0.8 mm</b>				<b>88.01</b>

IX23 || Subject to modifications. Please note that some products may not be available in all countries. Please always take note of the information that is provided with the product. For more detailed information, please consult with your contact partner or directly with Richard Wolf GmbH.

## TECHNICAL DATA OF ENDOCAM D CAMERA CONTROL UNIT

D camera control unit		5522101
<b>Device properties</b>		
Type of controls	Mechanical buttons	
Max. video signal resolution	1,920 x 1,080 pixels	
Brightness control	Automatic shutter control + automatic gain control	
Digital zoom	2.5x max.	
Operating conditions	+10 °C to +40 °C, 30 % to 75 % rel. humidity, atmospheric pressure 700 hPa to 1,060 hPa	
Storage and transport conditions	-20 °C to +60 °C, 10 % to 90 % rel. humidity, atmospheric pressure 700 hPa to 1,060 hPa	
Operating mode	Continuous operation	
<b>Equipment</b>		
IP rating	IP 20	
<b>Power supply</b>		
Mains + frequency	100–240 V AC, 50/60 Hz	
Power consumption	32 VA	
Current consumption	0.32–0.13 A	
Fuse	T 1.25 AH 250 V	
<b>Regulatory standards</b>		
Safety	UL 2601-1/CSA C22.2 No.601.1 – for USA	
EMC	EN/IEC 60601-1-2	
Medical device class	Class 1	
Classification of applied part	CF	
<b>Interfaces</b>		
Video outputs	1x 3G-SDI, 1x HDMI	
USB port (on front panel, for external storage media)	USB 2.0 (FAT32/NTFS formatting)	
Resolution (HDMI output)	Adjustable via DIP switches on housing rear	
	SXGA	1,280 x 1,024 p (50 Hz) (5:4)
Resolution (3G-SDI output)	Full HD	1,920 x 1,080 p (60 Hz) (16:9)
	1,920 x 1,080 p (60 Hz)	
<b>Dimensions and weights</b>		
Weight	2.3 kg	
Dimensions (W x H x D)	200 x 60 x 220 mm	

# DILATORS

## FOR PERCUTANEOUS UNIVERSAL NEPHROSCOPES



8955.185/27

**AUTOCLAVE**  
**134° C / 273° F**

for dilatation of the puncture channel		Outer Ø	TL	Product no.
<b>Dilator 6 FR</b>	Cannulated	6 Fr	500 mm	<b>8955.06</b>
<b>Telescopic dilator 9–18 FR bndl</b>	consisting of: dilator 6 FR (8955.06)	6 Fr	500 mm	<b>8955.180</b>
	Telescopic dilator 9 FR (8955.091)	9 Fr	230 mm	
	Telescopic dilator 12 FR (8955.121)	12 Fr		
	Telescopic dilator 15 FR (8955.151)	15 Fr		
	Telescopic dilator 18 FR (8955.181)	18 Fr		
<b>Telescopic dilator 9–27 FR bndl</b>	consisting of: dilator 6 FR (8955.06)	6 Fr	500 mm	<b>8955270</b>
	Telescopic dilator 9 FR (8955.091)	9 Fr	230 mm	
	Telescopic dilator 12 FR (8955.121)	12 Fr		
	Telescopic dilator 15 FR (8955.151)	15 Fr		
	Telescopic dilator 18 FR (8955.181)	18 Fr		
	Telescopic dilator 21 FR (8955.211)	21 Fr		
	Telescopic dilator 24 FR (8955.241)	24 Fr		
	Telescopic dilator 27 FR (8955.271)	27 Fr		
<b>Dilator 12 FR</b>	Cannulated, for one-step bouginage	12 Fr	320 mm	<b>8968.012</b>
<b>Dilator 15 FR</b>	Cannulated, for one-step bouginage	15 Fr	320 mm	<b>8968.015</b>
<b>Dilator 30 FR</b>	Fits the 27 Fr dilator from 8955.27	30 Fr	230 mm	<b>8955.308</b>
<b>Dilator 9 FR</b>	for inserting a second guide wire	9 Fr	600 mm	<b>8962.19</b>

IX23 || Subject to modifications. Please note that some products may not be available in all countries. Please always take note of the information that is provided with the product. for more detailed information, please consult with your contact partner or directly with Richard Wolf GmbH.

# MINI NEPHROSCOPE 15/18 FR

BY LAHME

ALSO SUITABLE FOR CHILDREN AND ADOLESCENTS

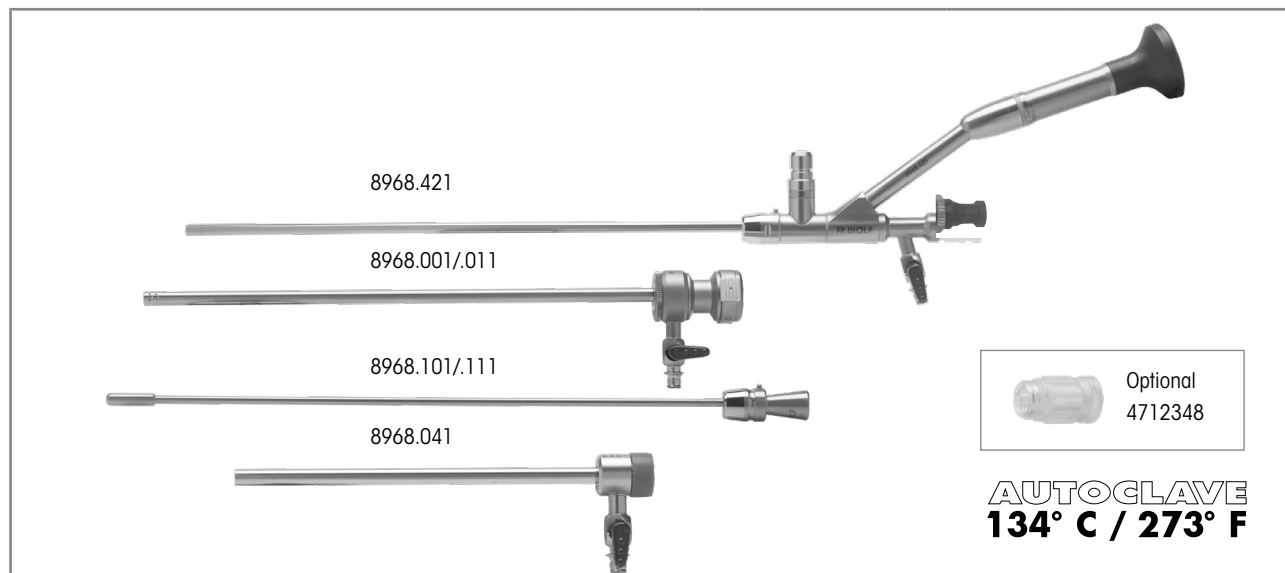

PANOVIEW	Direction of view	Ø	Maximum capacity	WL/SL	TL	Product no.
<b>Nephroscope 12° 12 FR WL 225 mm</b> with laterally offset eyepiece Working channel for instruments up to 6 FR	12°	12 Fr	6 Fr (2 mm)	WL 225 mm	406 mm	<b>8968.421</b>
<b>Sheath for nephroscope 15 FR</b>	-	15 Fr	12 Fr (4 mm)	SL 205 mm	-	<b>8968.001</b>
<b>Obturator for nephroscope 15 FR</b>	-	-	3.5 Fr (1.2 mm)	229 mm	-	<b>8968.101</b>
<b>Sheath for nephroscope 18 FR</b> Round, rotatable irrigation valve	-	18 Fr	15 Fr (5 mm)	SL 205 mm	-	<b>8968.011</b>
<b>Sheath for nephroscope 18 FR</b> Round, fixed irrigation valve	-	18 Fr	15 Fr (5 mm)	SL 150 mm	-	<b>8968.041</b>
<b>Obturator for nephroscope 18 FR</b>	-	-	3.5 Fr (1.2 mm)	WL 229 mm	-	<b>8968.111</b>

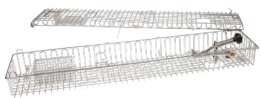
Recommended accessories		Product no.
for inserting auxiliary instruments of 1–6 FR: <b>universal sealing valve 1–6 FR</b> , sterile (PU = 5 PCS)		<b>4712348</b>
<b>Fiber light cable bndl</b> consisting of: Fiber light cable (80662523), projector-side adapter (8095.07), and endoscope-side adapter (809509)	Ø 2.5 mm, 2.3 m long	<b>806625231</b>
<b>Perforated basket, upper urinary tract 1</b> with small part basket	 Internal dimensions (W x H x D): 619 x 65 x 124 mm External dimensions (W x H x D): 635 x 75 x 132 mm	<b>38003</b>
<b>Marking pen</b>	Color: black	<b>38201.948</b>

MINI NEPHROSCOPE BY LAHME

2.8

IX23 || Subject to modifications. Please note that some products may not be available in all countries. Please always take note of the information that is provided with the product. For more detailed information, please consult with your contact partner or directly with Richard Wolf GmbH.

## AUXILIARY INSTRUMENTS

FOR MINIATURE NEPHROSCOPE

15/18 FR LAHME

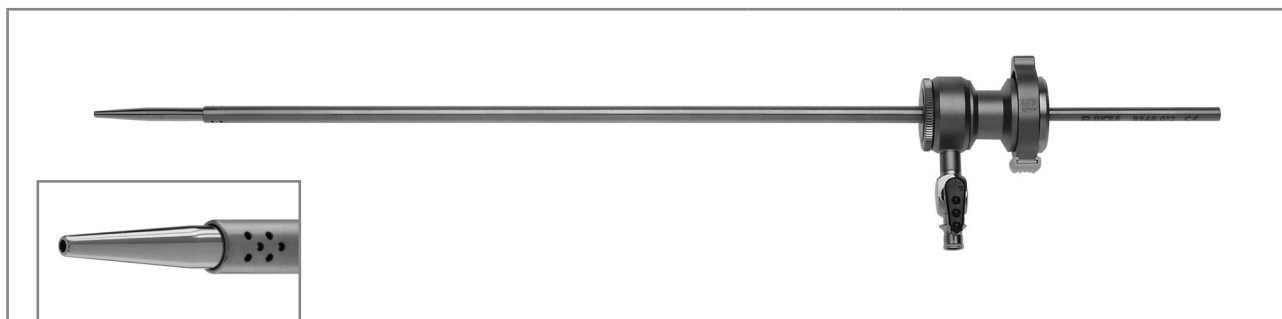

"One-step" bouginage		Outer Ø	TL	Product no.
<b>Dilator 12 FR</b>	Cannulated, for one-step bouginage	12 Fr	320 mm	<b>8968.012</b>
<b>Dilator 15 FR</b>	Cannulated, for one-step bouginage	15 Fr	320 mm	<b>8968.015</b>

**Note:** Can also be used with telescopic dilators, of course.





Further accessories	Outer Ø	WL	Product no.
Sonotrode Ø 1.9 mm WL 361 mm	1.9 mm	361 mm	<b>8962.519</b>
LithoClast probe Ø 2.0 mm, WL 425 mm	2.0 mm	425 mm	<b>8742.004</b>
Membrane holder			<b>15256.393</b>
Membrane holder			<b>15256.456</b>
Seal Ø 7.5 mm	7.5 mm		<b>89.101</b>
Universal sealing valve 1–6 FR, sterile (PU = 5 PCS)			<b>4712348</b>



IX23 || Subject to modifications. Please note that some products may not be available in all countries. Please always take note of the information that is provided with the product. For more detailed information, please consult with your contact partner or directly with Richard Wolf GmbH.

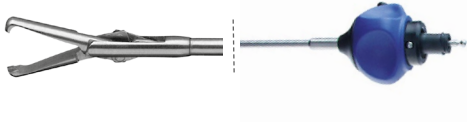

## AUXILIARY INSTRUMENTS

FOR MINIATURE NEPHROSCOPE  
15/18 FR LAHME

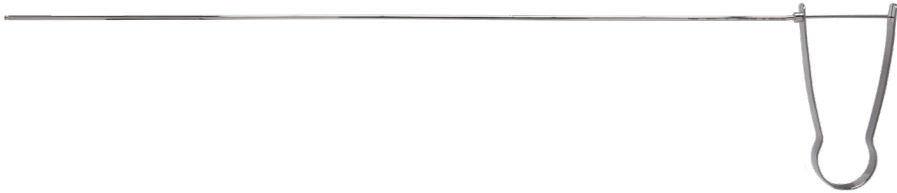
Grasping forceps jaw insert with sheath				Handle with overload protection	Complete instrument • Jaw section • Handle
  					
	Product no.	Fr	WL	8083.001	Product no.
<b>Grasping forceps bndl</b> Mouse tooth 	8959.6218	5 Fr	425 mm	•	<b>8959.6212</b>
<b>Grasping forceps bndl</b> Pike-mouth jaws 	8968.6808	6 Fr	425 mm	•	<b>8968.6802</b>

					
Grasping forceps		Outer Ø	WL	TL	Product no.
	<b>Rigid grasping forceps 6 FR WL 365 mm</b> Three arms, detachable	6 Fr	365 mm	410 mm	<b>8968.671</b>
	<b>Grasping forceps jaw insert 6 FR</b> Three arms, detachable	6 Fr	365 mm	-	<b>8968.675</b>

# PERCUTANEOUS UNIVERSAL NEPHROSCOPE

## "DRESDEN" MODEL

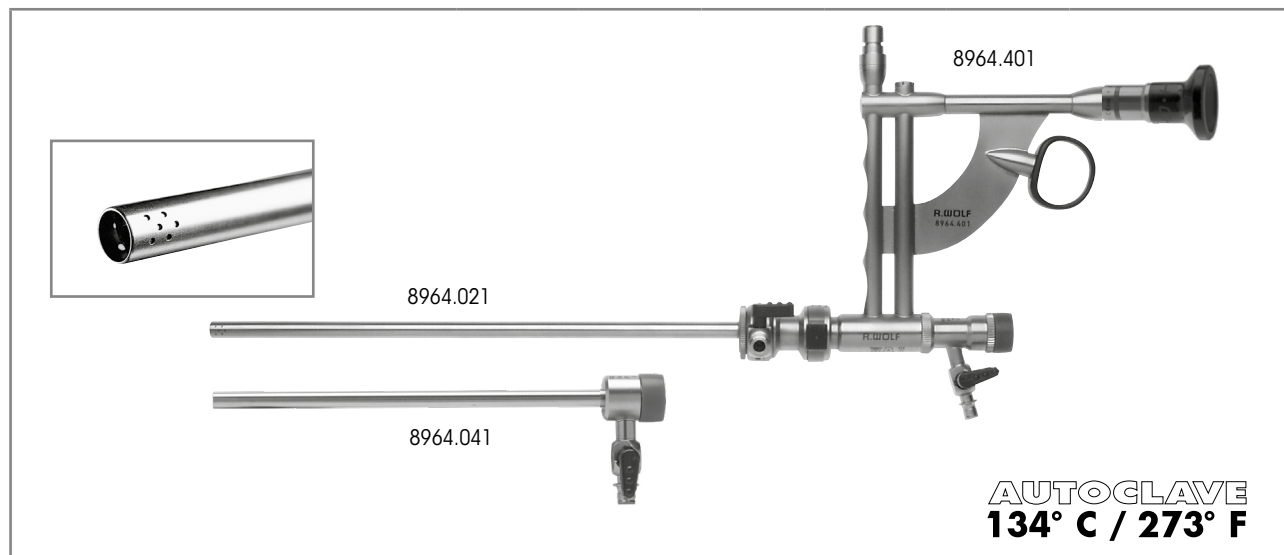

PANOVIEW	Direction of view	Ø	Maximum capacity	WL/SL	TL	Product no.
<b>Nephroscope 12° 20.8 FR WL 224 mm</b> with parallel eyepiece working channel for instruments up to 10.5 FR	12°	20.8 Fr	3.5 mm	WL 224 mm	387 mm	<b>8964.401</b>
<b>Sheath for nephroscope 20.8 FR</b>	-	20.8 Fr	-	SL 204 mm	-	<b>8964.021</b>
<b>Obturator for nephroscope 20.8 FR</b>	-	20.8 Fr	-	WL 230 mm	-	<b>8964.121</b>
Alternative:						
<b>Sheath for nephroscope 24 FR</b>	-	24 Fr	-	SL 204 mm	-	<b>8965.041</b>
Also: <b>obturator for nephroscope 24 FR</b>	-	24 Fr	-	WL 229 mm	-	<b>8965.141</b>
<b>Amplatz sheath for nephroscope 24.3 FR</b>	-	24.3 Fr	-	SL 150 mm	-	<b>8964.041</b>
<b>Sealing element</b>						<b>15176.100</b>

Option of optical percutaneous ureterotomy:		Product no.
<b>Working element, urethrotome, passive 0°</b>	Receptacle for stricture scalpels	<b>8670.911</b>
<b>Telescope 0° Ø 3.3 mm WL 297 mm</b>		<b>8660.424</b>
<b>Scalpel 16.5 FR ceramic, lancet-shaped</b>	12 o'clock cutting position, with ceramic cutter	<b>64164.038</b>

IX23 | Subject to modifications. Please note that some products may not be available in all countries. Please always take note of the information that is provided with the product. For more detailed information, please consult with your contact partner or directly with Richard Wolf GmbH.

# PERCUTANEOUS UNIVERSAL NEPHROSCOPES

24 FR

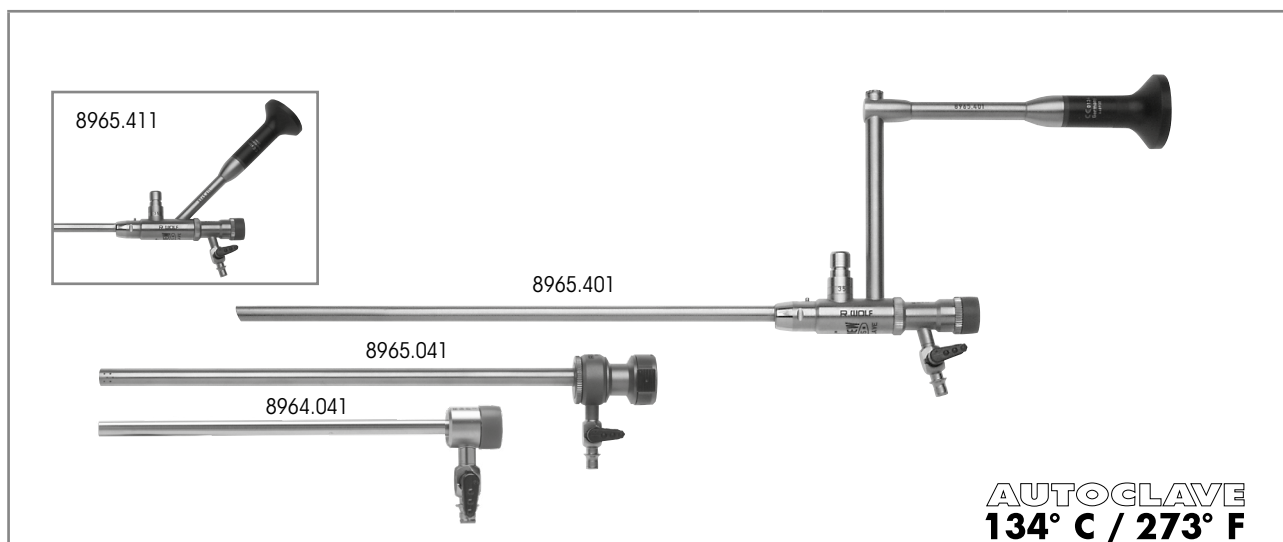

PANOVIEW	Direction of view	Ø	Maximum capacity	WL/SL	TL	Product no.
<b>Nephroscope 20° 24 FR WL 224 mm</b> with parallel eyepiece working channel for instruments up to 10.5 FR	20°	24 Fr	3.5 mm	WL 224 mm	387 mm	<b>8965.401</b>
<b>Nephroscope 20° 24 FR WL 224 mm</b> with lateral eyepiece working channel for instruments up to 10.5 FR	20°	24 Fr	3.5 mm	WL 224 mm	387 mm	<b>8965.411</b>
<b>Sheath for nephroscope 20.8 FR</b>	-	20.8 Fr	-	SL 204 mm	-	<b>8964.021</b>
<b>Obturator for nephroscope 20.8 FR</b>	-	20.8 Fr	-	WL 230 mm	-	<b>8964.121</b>
Alternative:						
<b>Sheath for nephroscope 24 FR</b>	-	24 Fr	-	SL 204 mm	-	<b>8965.041</b>
Also: <b>obturator for nephroscope 24 FR</b>	-	24 Fr	-	WL 229 mm	-	<b>8965.141</b>
<b>Amplatz sheath for nephroscope 24.3 FR</b>	-	24.3 Fr	-	SL 150 mm	-	<b>8964.041</b>
<b>Sealing element</b>						<b>15176.100</b>
<b>Option of optical percutaneous ureterotomy:</b>						<b>Product no.</b>
<b>Working element, urethrotome, passive 0°</b>	Receptacle for stricture scalpels					<b>8670.911</b>
<b>Telescope 0° Ø 4 mm WL 298 mm</b>						<b>8650.414</b>
<b>Scalpel 16.5 FR ceramic, lancet-shaped</b>	12 o'clock cutting position, with ceramic cutter					<b>64164.038</b>

PERCUTANEOUS UNIVERSAL NEPHROSCOPES

2.10

IX23 || Subject to modifications. Please note that some products may not be available in all countries. Please always take note of the information that is provided with the product. For more detailed information, please consult with your contact partner or directly with Richard Wolf GmbH.



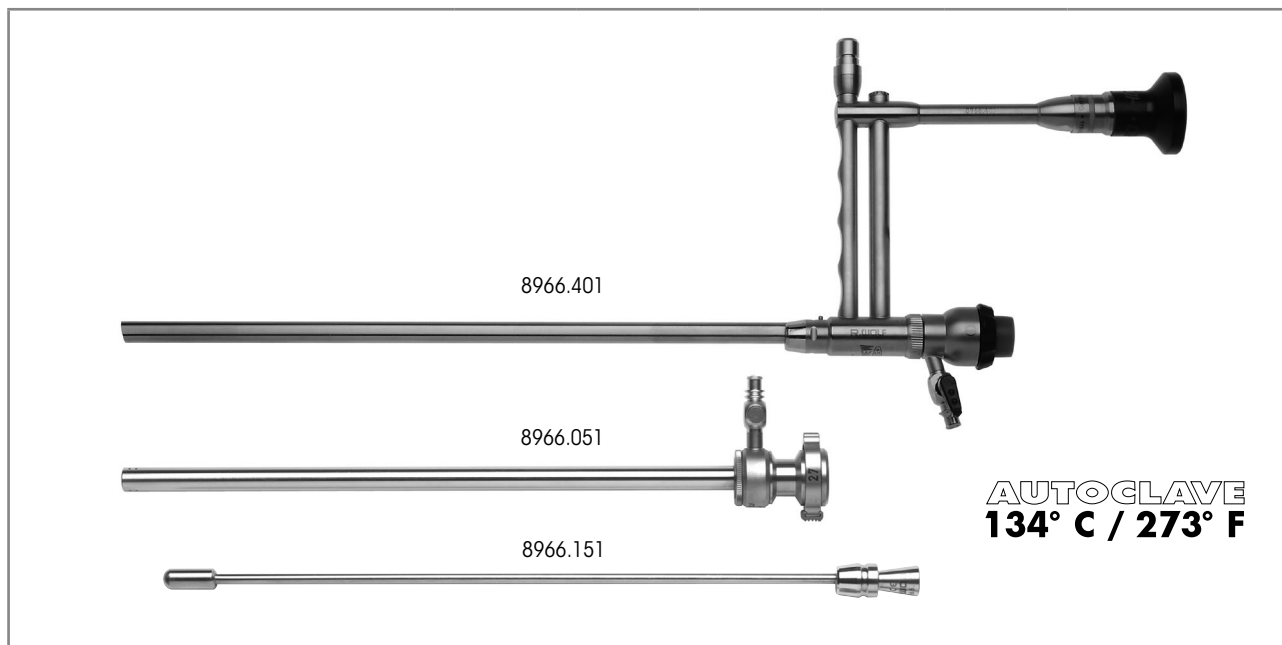

# PERCUTANEOUS UNIVERSAL NEPHROSCOPE

## LONG VERSION FOR OBESE PATIENTS



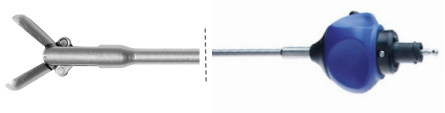

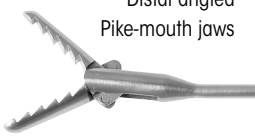
PANOVIEW	Direction of view	Ø	Maximum capacity	WL/SL	TL	Product no.
<b>Nephroscope bndl</b>	consisting of: Nephroscope 12° 27 FR WL 250 mm (8966.401) Sealing membrane Ø 17 mm (89.103) Sealing cap capacity 3.4–5.1 mm (89.03) (PU = 10 PCS) Sealing element (15176.106)					<b>89664011</b>
<b>Nephroscope 12° 27 FR WL 250 mm</b> with parallel eyepiece	12°	24 Fr	3.5 mm	WL 224 mm	387 mm	<b>8966.401</b>
<b>Sheath for nephroscope 27 FR</b>	-	27 Fr	-	SL 230 mm	-	<b>8966.051</b>
<b>Obturator for nephroscope 27 FR</b>	-	27 Fr	-	WL 256 mm	-	<b>8966.151</b>

## AUXILIARY INSTRUMENTS FOR PERCUTANEOUS UNIVERSAL NEPHROSCOPES







Grasping forceps jaw insert with sheath				Handle with overload protection	Complete instrument • Jaw section • Handle
 					
	Product no.	Fr	WL	8083.001	Product no.
 <p><b>Grasping forceps bndl</b> Distal angled Pike-mouth jaws</p>	8962.6028	9 Fr	355 mm	•	<b>8962.6022</b>
 <p><b>Grasping forceps bndl</b> Pike-mouth jaws</p>	8962.6108	10.5 Fr	350 mm	•	<b>8962.6102</b>

Grasping forceps		Outer Ø	WL	TL	Product no.
 <p><b>Rigid grasping forceps 10.5 FR WL</b> <b>365 mm</b> Three arms, detachable</p>		10.5 Fr	365 mm	410 mm	<b>8964.671</b>

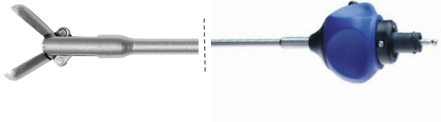
Further accessories		Product no.
<p><b>Fiber light cable bndl</b> consisting of: Fiber light cable (80663523), projector-side adapter (8095.07), and endoscope-side adapter (809509)</p>		<p>Ø 3.5 mm, 2.3 m long</p> <p><b>806635231</b></p>
<p><b>Perforated basket for nephroscope</b> with small part basket</p>		<p>Internal dimensions (W x H x D): 451 x 65 x 164 mm External dimensions (W x H x D): 467 x 75 x 172 mm</p> <p><b>38011</b></p>

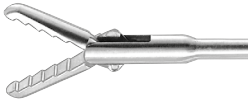
## RIGID AUXILIARY INSTRUMENTS

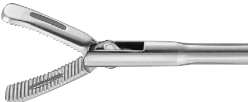
FORCEPS AND SCISSORS, SMALL MODULAR SYSTEM **HySafe**  
 360° ROTATABLE, CAN BE FLUSHED THROUGH, EASY-CLICK

Grasping forceps jaw insert with sheath				Handle with overload protection	Complete instrument • Jaw section • Handle	
						
	Product no.	Fr	WL	8083.001	Product no.	
	<b>Grasping forceps bndl</b> Pike-mouth jaws	8962.6008	10.5 Fr	350 mm	•	<b>8962.6002</b>
		8962.6048	12 Fr	355 mm	•	<b>8962.6042</b>
	<b>Grasping forceps bndl</b> Distal angled Pike-mouth jaws	8962.6028	9 Fr	355 mm	•	<b>8962.6022</b>
	<b>Grasping forceps bndl</b> Pike-mouth jaws	8962.6108	10.5 Fr	350 mm	•	<b>8962.6102</b>
	<b>Grasping forceps bndl</b> Peanut shape, fine toothing	8962.6078	12 Fr	340 mm	•	<b>8962.6072</b>
	<b>Grasping forceps bndl</b> Mouse tooth	8962.6058	12 Fr	340 mm	•	<b>8962.6052</b>
	<b>Grasping forceps bndl</b> Pike-mouth jaws	8962.6808	6 Fr	425 mm	•	<b>8968.6802</b>

IX23 || Subject to modifications. Please note that some products may not be available in all countries. Please always take note of the information that is provided with the product. For more detailed information, please consult with your contact partner or directly with Richard Wolf GmbH.

# FLEXIBLE FIBER NEPHROSCOPE 5 MM/15 FR

## CHANNEL 2.5 MM/7.5 FR

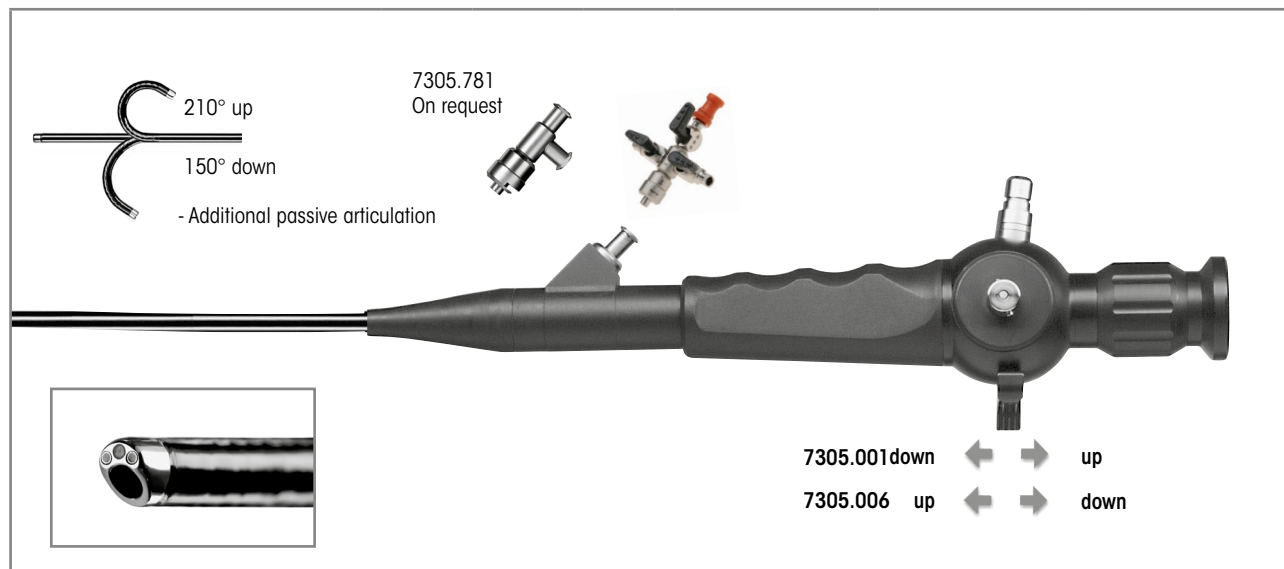

	Outer Ø	Working channel	WL	Control lever in distal direction – articulation downward	Control lever in distal direction – articulation upward	Product no.
<b>Fiber cystoscope 15 FR WL 400 mm</b> Slanted distal tip Articulation +210°/-150° Direction of view 0°, angle of view 110°	15 Fr	7.5 Fr	400 mm	•		<b>7305.001</b>
				•	<b>7305.006</b>	
<b>Fiber cystoscope bndl</b> consisting of: Fiber cystoscope 15 FR WL 400 mm (7305.001) Adapter with 2 irrigation valves and 1 instrument port (7305.782) Leakage tester for flex. endoscopes (163.903) Pressure equalization valve (163.904) Cleaning brush Ø 3 mm, TL 1,200 mm (PU = 10 PCS) (7990002)				•		<b>730500111</b>
<b>Fiber cystoscope bndl</b> consisting of: Fiber cystoscope 15 FR WL 400 mm (7305.006) Adapter with 2 irrigation valves and 1 instrument port (7305.782) Leakage tester for flex. endoscopes (163.903) Pressure equalization valve (163.904) Cleaning brush Ø 3 mm, TL 1,200 mm (PU = 10 PCS) (7990002)					•	<b>730500611</b>

Recommended accessories		Product no.
<b>Fiber light cable bndl</b> consisting of: Fiber light cable Ø 2.5 mm, TL 2.3 m (80662523), projector-side adapter (8095.07), and endoscope-side adapter (809509)		Ø 2.5 mm, 2.3 m long <b>806625231</b>
<b>Perforated basket for flexible endoscopes</b> Also: <b>fixing ring Ø 50.39 mm</b>		(W x H x D): 448 x 106 x 288 mm <b>33016</b> <b>643301261</b>
<b>Flexible auxiliary instruments</b>		see section Auxiliary instruments

IX23 || Subject to modifications. Please note that some products may not be available in all countries. Please always take note of the information that is provided with the product. For more detailed information, please consult with your contact partner or directly with Richard Wolf GmbH.

## FLEXIBLE FIBER NEPHROSCOPE 5 MM/15 FR

### TECHNICAL DATA

Fiber cystoscope 15 FR WL 400 mm	7305.001/7305.006
Distal tip	Slanted distal tip
Sheath diameter	15 Fr
Number of working channels	1
Working/irrigation channel diameter	7.5 Fr
Articulation	210° upward, 150° downward
Working length	400 mm
Angle of view	110°
Direction of view	0°



# MEGA Pulse<sup>70+</sup>

## 70 W HOLMIUM:YAG LASER SYSTEM FOR STONE AND BPH THERAPY



	Product no.
<p>MegaPulse 70+ <b>Laser surgical device tower EU bndI</b> consisting of: MegaPulse 70+ laser surgical device tower 70 W (2286007) 2x laser protection goggles (OBM003603) 1x key set (2286525) 1x door contact plug (2286520) 2x blast shield with mounting (OAM001523) 1x filling bottle with tube (IAM000088) 1x 2-pedal footswitch (2030232) 1x fiber-stripping forceps for stripping laser fibers, 0.3 to 1.0 mm (2286523) 1x fiber-stripping forceps for stripping laser fibers, 0.1 to 0.4 mm (2286527) 1x ceramic cutter with silicone pad (AGM000080) 1x accessories box for MegaPulse (KBM000103) 1x power cable TL 3 m (2286230)</p>	<p><b>22860070</b></p>

"MEGA PULSE 70+" LASER

2.12

IX23 || Subject to modifications. Please note that some products may not be available in all countries. Please always take note of the information that is provided with the product. For more detailed information, please consult with your contact partner or directly with Richard Wolf GmbH.

# MEGA Pulse 70<sup>+</sup>

## TECHNICAL DATA

MEGA Pulse 70 <sup>+</sup>		22860070
<b>Device properties</b>		
Display	12" touchscreen	
Power	70 watts	
Laser type	Holmium:YAG laser (Ho:YAG)	
Wavelength	2,100 nm (2.1 µm)	
Operating principle	Pulsed	
Energy	200–5,000 mJ	
Pulse duration	Adjustable (50–1,100 µs)	
Pilot beam	Green: 532 nm, < 5 mW, can be set to continuous or flashing	
Max. operating temperature	10–30 °C	
Storage temperature	Min. +5 °C, max. 40 °C	
<b>Power supply</b>		
Voltage	200–230 V, 50/60 Hz, < 32 A	
Frequency	3–60 Hz	
<b>Dimensions and weights</b>		
Dimensions (W x H x D)	595 x 1,200 x 1,074 mm	
Weight	200 kg	

IX23 || Subject to modifications. Please note that some products may not be available in all countries. Please always take note of the information that is provided with the product. For more detailed information, please consult with your contact partner or directly with Richard Wolf GmbH.

"MEGA PULSE 70<sup>+</sup>" LASER

2.12

# MEGA Pulse<sup>70+</sup>

## LASER FIBERS

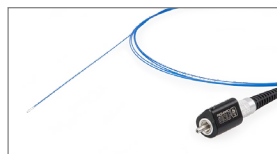

Sterile (PU= 1 PC)		Core diameter						Product no.
		200 µm	200 µm	272 µm	365 µm	550 µm	800 µm	
Single use	Power laser fiber Ø 200 µm, disposable	●						487502200
	Laser fiber Ø 200 µm, disposable		●					487501200
	Laser fiber Ø 272 µm, disposable			●				487501272
	Laser fiber Ø 365 µm, disposable				●			4875013650
	Laser fiber Ø 550 µm, disposable					●		487501550
	Laser fiber Ø 800 µm, disposable						●	487501800
	Laser fiber Ø 1,000 µm, disposable							●
Multiple use	Power laser fiber Ø 200 µm, reusable	●						87502200
	Laser fiber Ø 200 µm, reusable		●					87501200
	Laser fiber Ø 272 µm, reusable			●				87501272
	Laser fiber Ø 365 µm, reusable				●			875013650
	Laser fiber Ø 550 µm, reusable					●		87501550
	Laser fiber Ø 800 µm, reusable						●	87501800
	Laser fiber Ø 1,000 µm, reusable							●

# MEGA Pulse<sup>70+</sup>

## ACCESSORIES

Accessories		Product no.	
Fiber-stripping forceps, autoclavable	for stripping laser fibers	Ø 200–272 µm	<b>AGM000053</b>
		Ø 365–400 µm	<b>AGM000078</b>
		Ø 550–600 µm	<b>AGM000052</b>
		Ø 800 µm	<b>AGM000064</b>
Fiber-stripping forceps	for stripping laser fibers	Ø 0.1–0.4 mm	<b>2286527</b>
		Ø 0.3–1.0 mm	<b>2286523</b>
Ceramic cutter with silicone pad		<b>AGM000080</b>	
Filling bottle with tube		<b>IAM000088</b>	
Laser protection goggles	(Also suitable for glasses-wearers)	<b>OBM003603</b>	
2-pedal footswitch		<b>2030232</b>	
Key set		<b>2286525</b>	
Door contact plug		<b>2286520</b>	
Blast shield with mounting		<b>OAM001523</b>	
Power cable TL 3 m		<b>2286230</b>	
Accessories box for MegaPulse		<b>KBM000103</b>	
Adapter cable	CEE coupling, 3-pin 32 A 6 h 230 V AC blue (on the device side) and CEE plug, 5-pin 32 A 6 h 400 V AC red (in-house)	<b>100-201-0518</b>	

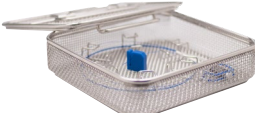
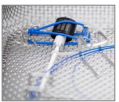
Machine reprocessing		Product no.
 <b>Perforated basket for laser fiber</b>	Holds: Laser fiber, for machine reprocessing, sterilization (steam and low-temperature), storage, and transport; internal dimensions (W x H x D): 231 x 52 x 223 mm external dimensions (W x H x D): 248 x 72 x 239 mm	<b>38001</b>
Also:  <b>Fixing ring Ø 34.6 mm</b>	for holding instruments during machine reprocessing, sterilization (steam and low-temperature), storage, and transport, Ø 34.6 x 2.62 mm, PU = 5 PCS	<b>643301262</b>

# Pulvis 60<sup>+</sup>

60 W THULIUM FIBER LASER (TFL)

FOR STONE THERAPY AND ENDOSCOPIC ENUCLEATION OF THE PROSTATE (EEP)



		Product no.
<p><b>Pulvis 60<sup>+</sup></b> 60 W thulium fiber laser (TFL)</p>	<p><b>PFMS00006</b></p>	

# Pulvis 60<sup>+</sup>

## 60 W THULIUM FIBER LASER (TFL) TECHNICAL DATA

Pulvis 60 <sup>+</sup>		PFMS00006	
<b>Device properties</b>			
Display	Fold-out, rotatable touchscreen display (rotates 90° to the right and 180° to the left)		
Operating temperature	15–30 °C (at a room temperature between 25 °C and 30 °C, operation is guaranteed with a maximum output power of up to 40 W)		
Storage/transport temperature	Min. +5 °C/max. 40 °C		
Atmospheric pressure	800–1,060 hPa		
Operating humidity	30–85 %, non-condensing		
Max. noise level	< 70.0 dB		
<b>Equipment</b>			
Cooling method	Air cooling system		
<b>Power supply</b>			
Mains + frequency	100–240 V AC, 50/60 Hz		
Power consumption	1,000 VA		
<b>Regulatory standards</b>			
Classification according to the Medical Devices Directive 93/42/EEC	Class IIb		
Laser classification according to IEC/EN 60825-1:2014	Class 4		
Pilot beam classification according with IEC/EN 60825-1:2014	Class 3R		
<b>Dimensions and weights</b>			
Weight	100 kg		
Dimensions (W x H x D)	470 x 1,156 x 810 mm 470 x 940 x 810 mm – display closed		

# Pulvis 60<sup>+</sup>

## 60 W THULIUM FIBER LASER (TFL)

### TECHNICAL DATA

Pulvis 60 <sup>+</sup>		PFMS00006
<b>Laser source specifications</b>		
Laser type	Thulium fiber-laser	
Wavelength	1,940 nm ± 20 nm	
Maximum output power	60 W (pulsed/CW)	
Pulse energy	0.02–6 J	
Operating mode	Pulsed/CW	
Pulse duration	50 µs – CW	
Frequency of recurrence	1–2,500 Hz	
Delivery system	Large selection of laser fibers (see next page) (sterile, disposable, and reusable)	
Pilot beam	Green 532 nm (adjustable) < 5 mW, class 3R	
Goggles	1940 D LB4	

# Pulvis 60<sup>+</sup>

## LASER FIBERS





Sterile (PU= 10 PCS)		Core diameter									Product no.
		150 µm	200 µm	272 µm	365 µm	500 µm	550 µm	600 µm	800 µm	1,000 µm	
Single use	Single use optical fiber 150 µm	●									OFJ001511
	Single use optical fiber 200 µm		●								OFJ002011
	Single use optical fiber 272 µm			●							OFJ702711
	Single use optical fiber ball tip 272 µm			●							OFJ302711
	Single use optical fiber 365 µm				●						OFJ703611
	Single use optical fiber 550 µm						●				OFJ005511
	Single use optical fiber lateral 600 µm							●			OFJ506011
	Single use optical fiber 800 µm								●		OFJ008011
	Single use optical fiber 1,000 µm									●	OFJ009911
Multiple use	Reusable 10x optical fiber 200 µm		●								OFJ002013
	Reusable 10x optical fiber 272 µm			●							OFJ702713
	Reusable 10x optical fiber 365 µm				●						OFJ703613
	Reusable 10x optical fiber 500 µm					●					OFJ005513
	Reusable 10x optical fiber 800 µm								●		OFJ008013
	Reusable 10x optical fiber 1,000 µm									●	OFJ009913



# Pulvis 60<sup>+</sup>

## ACCESSORIES

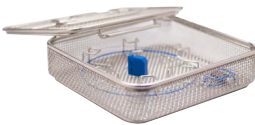
Accessories	Product no.
Interlock Conn. Medical Devices Binder	EAM000045.00
Key	MBQ000190.00
Power cord-5m-spina Shuko 16A EUR	EAM001440.00
Fiberstripper optical fibers Ø300-1000 µm	OBM001079.00
Fiberstripper optical fibers Ø100-400 µm	OBM001080.00
Case salsa 1650 no brand accessories	KBM000103.01
Ceramic fiber cutter with slipcase	AGM000080.00
Goggle protection f18.P1d09.1003	OBM003778.00
Optical blast shield for ffl ext-access	OAM002112.00

Machine reprocessing	Product no.
 <p><b>Perforated basket for laser fiber</b></p> <p>Holds: Laser fiber, for machine reprocessing, sterilization (steam and low-temperature), storage, and transport; internal dimensions (W x H x D): 231 x 52 x 223 mm external dimensions (W x H x D): 248 x 72 x 239 mm</p>	<b>38001</b>
<p>Also:</p>  <p><b>Fixing ring Ø 34.6 mm</b></p> <p>for holding instruments during machine reprocessing, sterilization (steam and low-temperature), storage, and transport, Ø 34.6 x 2.62 mm, PU = 5 PCS</p>	<b>643301262</b>

# FLUID CONTROL 2225

## SUCTION IRRIGATION PUMP

core



	Product no.
<p>FLUID CONTROL 2225  <b>Irrigation pump for HYS/URO/LAP bndI</b>                      consisting of:                      Irrigation pump for HYS/URO/LAP (2225001)                      and power cable 3 m long (2440.03)</p>	<b>22250011</b>
<b>Also:</b>	
<p><b>Balancing module</b>                      for hysteroscopy and endourology,                      fluid management for fluid balancing in combination with FLUID CONTROL 2225,                      mobile stand with integrated weighing cells and space for up to 4 irrigation fluid bags</p>	<b>2225023</b>

### Mini PCNL or standard PCNL

- Pressure and flow-controlled indication  
 Simultaneous monitoring of nominal pressure and irrigation flow
- Integrated vacuum function  
 Rapid fluid replacement for optimum viewing conditions

Accessories		Product no.
<b>Footswitch</b>	Only for use in urology and within the indication TUR/enucleation, possibility of short-term increase in pressure if visibility is poor (Flush function)	<b>2204901</b>

IX23 | Subject to modifications. Please note that some products may not be available in all countries. Please always take note of the information that is provided with the product. For more detailed information, please consult with your contact partner or directly with Richard Wolf GmbH.

# FLUID CONTROL 2225

## SUCTION IRRIGATION TUBE SETS

Irrigation			Product no.
<b>Accessories – reusable</b>	<b>Tube set with piercing spike</b>	with LUER-LOCK connection, autoclavable, incl. 10 spare membranes, reusable for 20 reprocessing cycles	<b>8171223</b>
<b>Accessories – disposable</b>	<b>Irrigation tube set with piercing spike, L 3 m</b>	(PU = 10 PCS), with LUER-LOCK connection, sterile, disposable product	<b>4171223</b>
	<b>Tube set with CARE-LOCK, L 3 m</b>	(PU = 10 PCS), sterile, disposable product	<b>4171224</b>
	<b>Suction irrigation tube set</b>	(PU = 10 PCS), with piercing spike, sterile, disposable product, PVC	<b>4171225</b>
	<b>Day irrigation tube set</b>	(PU = 10 PCS), sterile, disposable product, PVC	<b>4171226</b>
	<b>Patient irrigation tube set, sterile</b>	(PU = 10 PCS), with LUER-LOCK connection, sterile, disposable product, PVC	<b>4171227</b>
<i>Note: Day tube and patient tube can only be used together. A new patient tube is required for each patient – the day tube can be used for up to 20 patients.</i>			

Suction			Product no.
<b>Accessories – reusable</b>	<b>Tube set for vacuum, incl. filter</b>	with integrated hygiene filter, PU = 10 PCS, service life 30 days (connected to irrigation pump)	<b>2206207</b>
	<b>Irrigation tube</b>	L 1.2 m, with LUER-LOCK, for suction irrigation handle 8385.901 and tube set 8171223 or 8170.223	<b>817123</b>
	<b>Suction tube L 3 m</b>	for suction irrigation handle 8385.901	<b>8171402</b>
	<b>Secretion container 2 l</b>	2 liters, with lid	<b>8170.655</b>
	<b>Secretion container 2 l</b>	2 liters, no lid	<b>8170.6551</b>
<b>Accessories – disposable</b>	<b>Secretion container 2.5 l</b>	2.5 liters	<b>41706566</b>
	<b>Secretion container bndl consisting of:</b>	Secretion container 2.5 l (41706566) and secretion bag (PU = 90 PCS) (41706564)	<b>4170657</b>
	<b>Tube set for suction (2 connections)</b>	Sterile, disposable product (PU = 10 PCS) for connecting instruments to collecting container	<b>T0503-01</b>
	<b>Angled 90° plug-in coupling</b>	(PU = 10 PCS) for connecting vacuum tube 2206207 to disposable container systems	<b>0771019</b>

# FLUID CONTROL 2225

## CABLE ACCESSORIES

		Product no.
Patch cable, RJ45 SFTP, 0.5 m	Cable length 0.5 m	<b>72325378</b>
Patch cable, RJ45 HRS TM11, 1.0 m	Cable length 1.0 m	<b>72325429</b>
Patch cable, RJ45 S/FTP CAT.6 10 m	Cable length 10 m	<b>72325434</b>
Plastic caps for network socket	(PU = 8 PCS)	<b>5592105</b>
Power cable	Cable length 3 m	<b>2440.03</b>

IX23 || Subject to modifications. Please note that some products may not be available in all countries. Please always take note of the information that is provided with the product. For more detailed information, please consult with your contact partner or directly with Richard Wolf GmbH.

# TECHNICAL DATA

## FLUID CONTROL 2225

FLUID CONTROL 2225		2225001
<b>Device properties</b>		
Operating conditions		+10 °C to +40 °C, 30 % to 75 % rel. humidity, 70 to 106 kPa atmospheric pressure 3,000 m max. altitude above sea level
Storage and transport conditions		-20 °C to +60 °C, 10 % to 90 % rel. humidity, 70 to 106 kPa atmospheric pressure
<b>Power supply</b>		
Mains + frequency		100–240 V AC, 50/60 Hz
Power consumption	100 V/60 Hz	110 VA
	240 V/50 Hz	120 VA
Current consumption	100 V/60 Hz	1.10 A
	240 V/50 Hz	0.50 A
Fuse		T 3.15 AH, 250 V
<b>Regulatory standards</b>		
Protection class (I, II)		I
Electromagnetic compatibility (EMC)		EN 60601-1/IEC 60601-1 EN 60601-1-2/IEC 60601-1-2
Medical Devices Directive 93/42/EEC		Class IIb
Housing protection rating (IP code)		IP 21
Protection against electric shock		Type BF applied part
Degree of protection in the presence of flammable mixtures		Device is not protected against explosions (do not operate this device in explosive atmospheres)
Maximum suction vacuum		-60 kPa
<b>Dimensions and weights</b>		
Weight		8.8 kg
Dimensions (W x H x D)		300 mm x 157 mm x 436 mm
<b>Relevant application parameters</b>		
Nominal flow range		Hysteroscopy: 800 ml/min (max. flow, not adjustable) Endourology: 10–800 ml/min (max. flow) Laparoscopy: 0.1–1.8 l/min (max. flow)
Suction power		Max. 2 l/min
Starting nominal pressure range		Hysteroscopy: 15–200 mmHg Endourology: 15–90 mmHg/20–120 cmH2O Laparoscopy: 300 mmHg (not adjustable)
Pressure		0–300 mmHg
Deficit		-9,990 to +9,990 ml/0 to 99.9 l

# TECHNICAL DATA

## FLUID CONTROL 2225

Balancing module <b>2225023</b>	
<b>Device properties</b>	
Operating conditions	+10 °C to +40 °C, 30 % to 75 % rel. humidity, 70 to 106 kPa atmospheric pressure 3,000 m max. altitude above sea level
Storage and transport conditions	-20 °C to +60 °C, 10 % to 90 % rel. humidity, 70 to 106 kPa atmospheric pressure
<b>Regulatory standards</b>	
Electromagnetic compatibility (EMC)	EN 60601-1/IEC 60601-1 EN 60601-1-2/IEC 60601-1-2
Housing protection rating (IP code)	IP 21
Maximum load of container scale	16 kg/4 containers of 3 l each
Maximum load of bag scale	23 kg/4 bags of 5 l each
<b>Dimensions and weights</b>	
Weight	15.4 kg
Dimensions (W x H x D)	618 mm x 1,064 mm x 618 mm

Footswitch <b>2204901</b>	
<b>Power supply</b>	
Power supply connection	Max. 24 V
Power consumption	Max. 0.1 A
<b>Regulatory standards</b>	
Electromagnetic compatibility (EMC)	EN 60601-1/IEC 60601-1
Housing protection rating (IP code)	IP X8
Plug	7-pin circular connector
Cable length	4.5 m
<b>Dimensions and weights</b>	
Weight	300 g
Dimensions (W x H x D)	66 mm x 27 mm x 91 mm



**PEDIATRIC UROLOGY**

## PEDIATRIC UROLOGY

3.1

---

**OPTICAL URETHROTOME FOR NEWBORNS AND INFANTS**

---

3.2

---

**CYSTO-URETHROSCOPE 8686 FOR NEWBORNS AND INFANTS**

---

3.3

---

**CYSTO-URETHROSCOPE 8672 FOR INFANTS**

---

3.4

---

**MIDI-SIZE CYSTO-URETHROSCOPE FOR SMALL ANATOMIES**

---

3.5

---

**CYSTOSCOPE 4.5/6.5 FR FOR NEWBORNS AND INFANTS**

---

3.6

---

**CYSTOSCOPE 8/9.8 FR FOR REFLUX THERAPY IN INFANTS**

---

3.7

---

**RESECTOSCOPES FOR NEWBORNS AND INFANTS**

---

3.8

---

**MIDI-SIZE RESECTOSCOPE**

---

3.9

---

**ULTRA-THIN FIBER URETERORENOSCOPE**

---



*E-line*

# OPTICAL URETHROTOME

FOR TELESCOPE 1.9 MM

FOR NEWBORNS AND INFANTS



12 o'clock cutting position

**AUTOGLAVE**  
**134° C / 273° F**

Sheath for cystoscope bndl	consisting of:	Fr	Capacity in Fr	Color coding	Product no.
<b>Sheath for urethrotome 8.5 FR with irrigation valve</b>	Sheath for urethrotome 8.5 FR (8693.0145), obturator for urethrotome 8.5 FR (8693.0147), tube with LUER-LOCK connector (886.00)	8.5	3	Red	<b>8693.0141</b>

Also: individual sheaths and obturators





Individual sheath and obturator	SL/WL	Color coding	Product no.	Adapter for resectoscope	Working element for urethrotome passive 0°
<b>Sheath for urethrotome 8.5 FR</b>	SL 105 mm	Red	<b>8693.0145</b>	for diagnostics and probing <b>8688.264</b>	Receptacle for stricture scalpels <b>8693.914</b>
<b>Obturator for urethrotome 8.5 FR</b>	WL 123 mm	Red	<b>8693.0147</b>		

Also:



PANOVIEW telescope	Direction of view	Ø	WL	TL	Product no.
<b>Telescope 0° Ø 1.9 mm WL 178 mm</b>	0°	1.9 mm	178 mm	243 mm	<b>8686.414</b>



Stricture scalpels	Cutting edge	Product no.
 Scalpel 9 FR ceramic, semi-circular	Semi-circular	<b>8693.961</b>
 Scalpel 8.5 FR, sickle-shaped	Sickle-shaped	<b>8693.93</b>
 Scalpel 8.5 FR, hook-shaped	Hook-shaped	<b>8688.94</b>

Recommended accessories	Product no.
<b>Perforated basket for standard telescope 1</b>	Internal dimensions (W x H x D): 270 x 52 x 40 mm External dimensions (W x H x D): 297 x 54 x 59 mm <b>38015</b>
<b>Fiber light cable bndl</b> consisting of: Fiber light cable (80662523), projector-side adapter (8095.07), and endoscope-side adapter (809509)	Ø 2.5 mm, 2.3 m long <b>806625231</b>

*E-line*

# CYSTO-URETHROSCOPE 8686

FOR TELESCOPE 1.9 MM

FOR NEWBORNS AND INFANTS

CYSTO-URETHROSCOPE 8686

3.2



**AUTOCLAVE**  
**134° C / 273° F**

Sheath for cystoscope bndl	consisting of:	Fr	Color coding	Capacity	Product no.
<b>Sheath for cystoscope 7.5 FR</b> with 2 irrigation valves	Sheath for cystoscope 7.5 FR (8686.0145), obturator for cystoscope 7.5 FR (8686.0147)	7.5	Blue	-	<b>8686.0141</b>
<b>Sheath for cystoscope 8.5 FR</b> with 2 irrigation valves and 1 instrument port	Sheath for cystoscope 8.5 FR (8686.0245), obturator for cystoscope 8.5 FR (8686.0247)	8.5	Red	3 Fr	<b>8686.0241</b>
<b>Sheath for cystoscope 9.5 FR</b> with 2 irrigation valves and 1 instrument port	Sheath for cystoscope 9.5 FR (8686.0345), obturator for cystoscope 9.5 FR (8686.0347)	9.5	Yellow	4 Fr	<b>8686.0341</b>

Also: individual sheaths and obturators

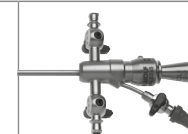
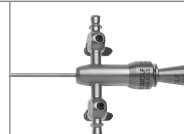

Individual sheath and obturator	SL/WL	Color coding	Product no.	Only for diagnostics (can only be used with telescope 0°)	1 instrument port
<b>Sheath for cystoscope 7.5 FR</b>	SL 146 mm	Blue	<b>8686.0145</b>	•	
<b>Obturator for cystoscope 7.5 FR</b>	SL 183 mm	Blue	<b>8686.0147</b>		
<b>Sheath for cystoscope 8.5 FR</b>	SL 145 mm	Red	<b>8686.0245</b>		•
<b>Obturator for cystoscope 8.5 FR</b>	WL 180 mm	Red	<b>8686.0247</b>		
<b>Sheath for cystoscope 9.5 FR</b>	SL 145 mm	Yellow	<b>8686.0345</b>		•
<b>Obturator for cystoscope 9.5 FR</b>	WL 180 mm	Yellow	<b>8686.0347</b>		

Also:



PANOVIEW telescope	Direction of view	Ø	WL	TL	Product no.
<b>Telescope 0° Ø 1.9 mm WL 178 mm</b>	0°	1.9 mm	178 mm	243 mm	<b>8686.414</b>
<b>Telescope 30° Ø 1.9 mm WL 179 mm</b>	30°	1.9 mm	179 mm	241 mm	<b>8686.415</b>

Recommended accessories	Product no.
<b>Perforated basket for standard telescope 2</b>	Internal dimensions (W x H x D): 454 x 52 x 40 mm External dimensions (W x H x D): 481 x 54 x 59 mm <b>38016</b>
<b>Fiber light cable bndl</b> consisting of: Fiber light cable (80662523), projector-side adapter (8095.07), and endoscope-side adapter (809509)	Ø 2.5 mm, 2.3 m long <b>806625231</b>

IX23 | Subject to modifications. Please note that some products may not be available in all countries. Please always take note of the information that is provided with the product. For more detailed information, please consult with your contact partner or directly with Richard Wolf GmbH.

*E-line*

# CYSTO-URETHROSCOPE 8672

FOR TELESCOPE 2.7 MM  
FOR INFANTS



**AUTOCLAVE**  
**134° C / 273° F**

Sheath for cystoscope bndl	consisting of:	Fr	Color coding	Capacity	Product no.
<b>Sheath for cystoscope 11 FR</b> with 2 irrigation valves	Sheath for cystoscope 11 FR (8672.0145), obturator for cystoscope 11 FR (8672.0147), tube with LUER-LOCK connector (886.00)	11	Red	-	<b>8672.0141</b>
<b>Sheath for cystoscope 12 FR</b> with 2 irrigation valves and 1 instrument port	Sheath for cystoscope 12 FR (8672.0245), obturator for cystoscope 12 FR (8686.0247), tube with LUER-LOCK connector (886.00), "RIVO" rubber cap, red-orange (15220.006)	12	Green	3 Fr	<b>8672.0241</b>
<b>Sheath for cystoscope 13 FR</b> with 2 irrigation valves and 2 instrument ports	Sheath for cystoscope 13 FR (8686.0345), obturator for cystoscope 13 FR (8686.0347), tube with LUER-LOCK connector (886.00), "RIVO" rubber cap, red-orange (15220.004), "RIVO" rubber cap, red-orange (15220.006)	13	Blue	4 Fr	<b>8672.0341</b>

Also: **individual sheaths and obturators**

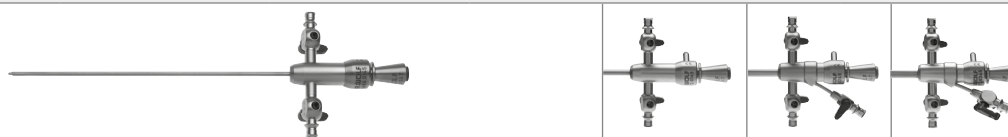

Individual sheath and obturator	SL/WL	Color coding	Product no.	Only for diagnostics	1 instrument port	2 instrument ports
<b>Sheath for cystoscope 11 FR</b>	SL 149 mm	Red	<b>8672.0145</b>	●		
<b>Obturator for cystoscope 11 FR</b>	WL 184 mm	Red	<b>8672.0147</b>			
<b>Sheath for cystoscope 12 FR</b>	SL 150 mm	Green	<b>8672.0245</b>		●	
<b>Obturator for cystoscope 12 FR</b>	WL 184 mm	Green	<b>8672.0247</b>			
<b>Sheath for cystoscope 13 FR</b>	SL 149 mm	Blue	<b>8672.0345</b>			●
<b>Obturator for cystoscope 13 FR</b>	WL 184 mm	Blue	<b>8672.0347</b>			

Also:



PANOVIEW telescope	Direction of view	Ø	WL	TL	Product no.
<b>Telescope 0° Ø 2.7 mm WL 182 mm</b>	<b>0°</b>	2.7 mm	182 mm	249 mm	<b>8672.421</b>
<b>Telescope 30° Ø 2.7 mm WL 182 mm</b>	<b>30°</b>	2.7 mm	182 mm	247 mm	<b>8672.422</b>
<b>Telescope 70° Ø 2.7 mm WL 185 mm</b>	<b>70°</b>	2.7 mm	185 mm	247 mm	<b>8672.425</b>

**Recommended accessories**

**Product no.**

<b>Perforated basket for standard telescope 2</b>	Internal dimensions (W x H x D): 454 x 52 x 40 mm External dimensions (W x H x D): 481 x 54 x 59 mm	<b>38016</b>
<b>Fiber light cable bndl</b> consisting of: Fiber light cable (80662523), projector-side adapter (8095.07), and endoscope-side adapter (809509)	Ø 2.5 mm, 2.3 m long	<b>806625231</b>

CYSTO-URETHROSCOPE 8672

3.3

IX23 || Subject to modifications. Please note that some products may not be available in all countries. Please always take note of the information that is provided with the product. For more detailed information, please consult with your contact partner or directly with Richard Wolf GmbH.

*E-line*

# CYSTO-URETHROSCOPE 8672

FOR TELESCOPE 2.7 MM  
FOR INFANTS

CYSTO-URETHROSCOPE 8672

3.3

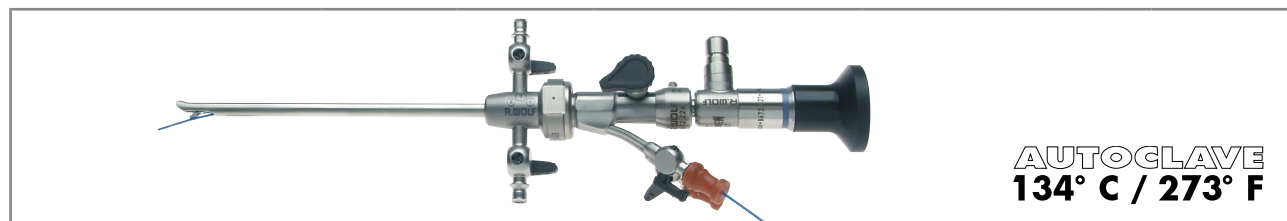

**AUTOCLAVE**  
**134° C / 273° F**

Sheath for cystoscope bndl	consisting of:	Fr	Color coding	Product no.
<b>Sheath for cystoscope 14 FR</b> with 2 irrigation valves	Sheath for cystoscope 14 FR (8672.0445), obturator for cystoscope 14 FR (8672.0447), tube with LUER-LOCK connector (886.00)	14	White	<b>8672.0441</b>

Also: individual sheaths and obturators



Individual sheath and obturator	SL/WL	Color coding	Capacity in Fr	Product no.	Adapter for cystoscope	Working insert for cystoscope 0/30/70 with Albarrán lever	
						1 instrument port	2 instrument ports
<b>Sheath for cystoscope 14 FR</b>	SL 119 mm	White	5	<b>8672.0445</b>	for urethroscopy <b>8672.264</b>	for cystoscopy <b>8672.214</b>	
			2 x 4				for cystoscopy <b>8672.224</b>
<b>Obturator for cystoscope 14 FR</b>	WL 137 mm	White		<b>8672.0447</b>			

Also:



PANOVIEW telescope	Direction of view	Ø	WL	TL	Product no.
<b>Telescope 0° Ø 2.7 mm WL 182 mm</b>	0°	2.7 mm	182 mm	249 mm	<b>8672.421</b>
<b>Telescope 30° Ø 2.7 mm WL 182 mm</b>	30°	2.7 mm	182 mm	247 mm	<b>8672.422</b>
<b>Telescope 70° Ø 2.7 mm WL 185 mm</b>	70°	2.7 mm	185 mm	247 mm	<b>8672.425</b>

Recommended accessories	Product no.
<b>Perforated basket for standard telescope 2</b>	Internal dimensions (W x H x D): 454 x 52 x 40 mm External dimensions (W x H x D): 481 x 54 x 59 mm <b>38016</b>
<b>Fiber light cable bndl</b> consisting of: Fiber light cable (80662523), projector-side adapter (8095.07), and endoscope-side adapter (809509)	Ø 2.5 mm, 2.3 m long <b>806625231</b>



IX23 | Subject to modifications. Please note that some products may not be available in all countries. Please always take note of the information that is provided with the product. For more detailed information, please consult with your contact partner or directly with Richard Wolf GmbH.

E-line

OPTICAL FORCEPS

FOR CYSTO-URETHROSCOPE 8672



for use with the 0° telescope 8672.421 in sheath 8672.0441		Suitable for sheaths from	Product no.
 <p><b>Opt. biopsy forceps, spoon-shaped</b></p>	Opening on both sides, through-cutting, for taking of biopsies	14 Fr	<b>8672.604</b>
 <p><b>Opt. grasping forceps, pike-mouth jaws</b></p>	Opening on both sides, for grasping foreign bodies	14 Fr	<b>8672.654</b>

CYSTO-URETHROSCOPE 8672  
3.3

IX23 || Subject to modifications. Please note that some products may not be available in all countries. Please always take note of the information that is provided with the product. For more detailed information, please consult with your contact partner or directly with Richard Wolf GmbH.



# FORCEPS AND SCISSORS

## SMALL MODULAR SYSTEM **HySafe**

### FOR CYSTO-URETHROSCOPE 8672

CYSTO-URETHROSCOPE 8672

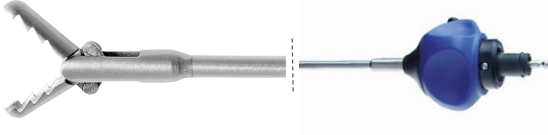

3.3

Grasping forceps jaw insert with sheath				Handle with overload protection	Complete instrument
					<ul style="list-style-type: none"> <li>• Jaw section</li> <li>• Handle</li> </ul>
	Product no.	Fr	WL	8083.001	Product no.
<b>Grasping forceps bndl</b> Distal angled with pike-mouth jaws	8642.6508	5	340 mm	•	<b>8642.6502</b>
	8645.6508	7	325 mm	•	<b>8645.6502</b>
<b>Grasping forceps bndl</b> - Spoon	8642.6008	5	340 mm	•	<b>8642.6002</b>
	8645.6008	7	340 mm	•	<b>8645.6002</b>
<b>Biopsy forceps bndl</b>	8642.6318	5	340 mm	•	<b>8642.6312</b>
<b>Scissors bndl</b>	8642.6818	5	340 mm	•	<b>8642.6812</b>
<b>Hook scissors bndl</b> Through-cutting	8992.6408	7	310 mm	•	<b>8992.6402</b>

- Can be flushed through – optimum internal cleaning
- Easy-Click – quick and simple assembly
- Overload protection – significantly longer service life

IX23 || Subject to modifications. Please note that some products may not be available in all countries. Please always take note of the information that is provided with the product. For more detailed information, please consult with your contact partner or directly with Richard Wolf GmbH.

## FLEXIBLE GRASPING FORCEPS FOR CYSTO-URETHROSCOPES 8672 AND 8686

				
	Fr	WL	TL	Product no.
 <b>Flex. scissors 4 FR WL 230 mm</b> with overload protection	4	230 mm	350 mm	<b>828.244</b>

CYSTO-URETHROSCOPE 8672

3.3

IX23 || Subject to modifications. Please note that some products may not be available in all countries. Please always take note of the information that is provided with the product. For more detailed information, please consult with your contact partner or directly with Richard Wolf GmbH.

# MIDI-SIZE

## CYSTO-URETHROSCOPE

for smaller anatomies  
Rösch



**AUTOCLAVE**  
134° C / 273° F

Sheath for cystoscope bndl	consisting of:	Fr	Capacity in Fr	Color coding	Product no.
<b>Sheath for cystoscope 12.5 FR</b> with 2 irrigation valves	Sheath for cystoscope 12.5 FR (86720255), obturator for cystoscope 12.5 FR (86720257), tube with LUER-LOCK connector (886.00)	12.5	5	Green	<b>86720251</b>
<b>Sheath for cystoscope 14.5 FR</b> with 2 irrigation valves	Sheath for cystoscope 14.5 FR (86720455), obturator for cystoscope 14.5 FR (86720457), tube with LUER-LOCK connector (886.00)	12	7	Green	<b>86720451</b>

Also: individual sheaths and obturators



Individual sheath and obturator	SL/WL	Color coding	Product no.	Adapter for cystoscope TL 65 mm
<b>Sheath for cystoscope 12.5 FR</b>	SL 193 mm	Green	<b>86720255</b>	<b>8672265</b>
<b>Obturator for cystoscope 12.5 FR</b>	WL 211 mm	Green	<b>86720257</b>	
<b>Sheath for cystoscope 14.5 FR</b>	SL 194 mm	White	<b>86720455</b>	
<b>Obturator for cystoscope 14.5 FR</b>	WL 211 mm	White	<b>86720457</b>	

Also:



PANOVIEW telescope	Ø	WL	TL	Product no.
<b>Telescope 30° Ø 2.7 mm WL 267 mm</b>	2.7 mm	267 mm	331 mm	<b>8672432</b>





Recommended accessories	Product no.
<b>Perforated basket for standard telescope 2</b>	Internal dimensions (W x H x D): 454 x 52 x 40 mm External dimensions (W x H x D): 481 x 54 x 59 mm <b>38016</b>
<b>Fiber light cable bndl</b> consisting of: Fiber light cable (80662523), projector-side adapter (8095.07), and endoscope-side adapter (809509)	Ø 2.5 mm, 2.3 m long <b>806625231</b>
<b>HF connection cable</b>	see UR0103/104

IX23 | Subject to modifications. Please note that some products may not be available in all countries. Please always take note of the information that is provided with the product. For more detailed information, please consult with your contact partner or directly with Richard Wolf GmbH.



## FLEXIBLE AUXILIARY INSTRUMENTS FOR **MIDI-SIZE**

		Outer Ø	WL	TL	Product no.
	Flex. biopsy forceps 5 FR WL 315 mm	5 Fr	315 mm	465 mm	<b>829.05</b>
	Flex. biopsy forceps 7 FR WL 375 mm	7 Fr	375 mm	490 mm	<b>829.07</b>
	Flex. grasping forceps 5 FR WL 315 mm	5 Fr	315 mm	465 mm	<b>828.05</b>
	Flex. grasping forceps 7 FR WL 365 mm	7 Fr	365 mm	515 mm	<b>828.07</b>
	Flex. scissors 7 FR WL 375 mm	7 Fr	375 mm	490 mm	<b>830.07</b>



# CYSTOSCOPE 4.5/6.5 FR

FOR NEWBORNS AND INFANTS



Optional  
4712348

**AUTOGLAVE**  
**134° C / 273° F**

	Direction of view	Working channel	WL	Product no.
<b>Cystoscope bndl</b> consisting of: Cystoscope 5° 4.5/6.5 FR WL 120 mm (8715.401), seal Ø 7.5 mm (PU = 10 PCS) (89.101), membrane holder (15256.393), and "RIWO" rubber cap, red-orange (15220.005)	5°	3.3 Fr	120 mm	<b>87154012</b>
Also:				
	<b>Flex. grasping forceps 3 FR WL 230 mm</b> Fine tothing		230 mm	<b>828.03</b>
	<b>Flex. biopsy forceps 3 FR WL 230 mm</b>		230 mm	<b>829.03</b>
	for inserting auxiliary instruments of 1–6 FR: <b>universal sealing valve 1–6 FR, sterile (PU = 5 PCS)</b>			<b>4712348</b>

Recommended accessories	Product no.
<b>Perforated basket for cystoscope/telescope</b> 	Internal dimensions (W x H x D): 451 x 65 x 124 mm External dimensions (W x H x D): 467 x 75 x 132 mm <b>38004</b>
<b>Fiber light cable bndl</b> consisting of: Fiber light cable (80662523), projector-side adapter (8095.07), and endoscope-side adapter (809509)	Ø 2.5 mm, 2.3 m long <b>806625231</b>

IX23 || Subject to modifications. Please note that some products may not be available in all countries. Please always take note of the information that is provided with the product. For more detailed information, please consult with your contact partner or directly with Richard Wolf GmbH.



CYSTOSCOPE 4.5/6.5 FR

3.5

# CYSTOSCOPE 8/9.8 FR

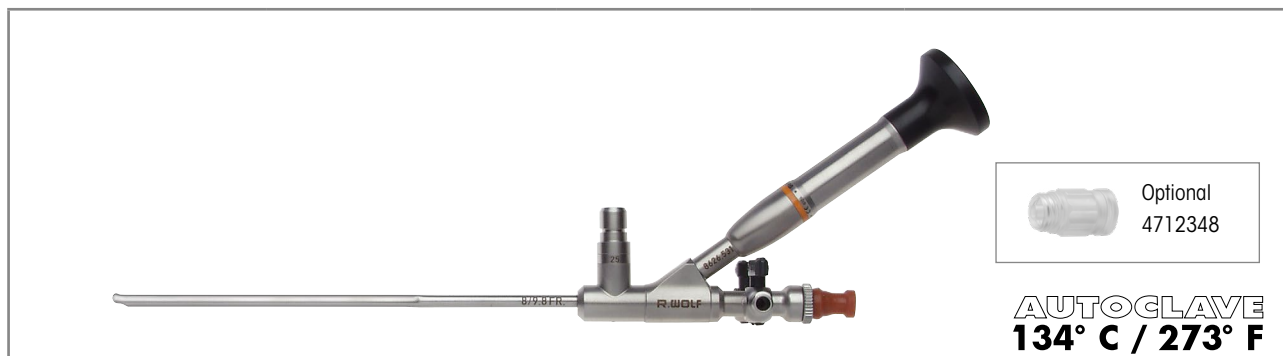
## FOR REFLUX THERAPY IN INFANTS



	Direction of view	Working channel	WL	Product no.
<b>Cystoscope 12° 8.0/9.8 FR WL 150 mm</b>	12°	5 Fr	150 mm	<b>8626.531</b>
<b>Also:</b>				
	<b>Rigid grasping forceps 5 FR WL 340 mm</b> Fine toothing, for splint removal		340 mm	<b>8626.65</b>
	<b>Coag. electrode mono 5 FR WL 400 mm</b>		400 mm	<b>823.05</b>
	for inserting auxiliary instruments of 1–6 FR: <b>universal sealing valve 1–6 FR, sterile (PU = 5 PCS)</b>			<b>4712348</b>

Recommended accessories		Product no.
	Internal dimensions (W x H x D): 451 x 65 x 124 mm External dimensions (W x H x D): 467 x 75 x 132 mm	<b>38004</b>
<b>Fiber light cable bndl</b> consisting of: Fiber light cable (80662523), projector-side adapter (8095.07), and endoscope-side adapter (809509)	Ø 2.5 mm, 2.3 m long	<b>806625231</b>

CYSTOSCOPE 8/9.8 FR

3.6

*E-line*

# RESECTOSCOPE



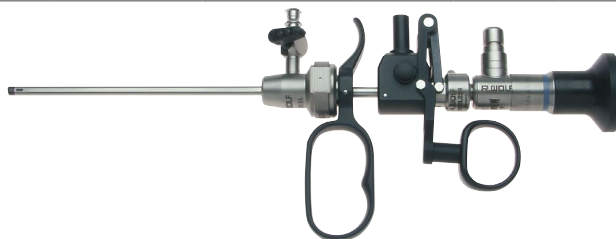

FOR TELESCOPE 1.9 MM

FOR NEWBORNS AND INFANTS



6 o'clock cutting position

**AUTOCLAVE**  
**134° C / 273° F**

Sheath for cystoscope bndl	consisting of:	Fr	Capacity in Fr	Color coding	Product no.
<b>Sheath for resectoscope 9 FR</b> with irrigation valve	Sheath for resectoscope 9 FR (8688.0145), obturator for resectoscope 9 FR (8688.0147), tube with LUER-LOCK connector (886.00)	9	3	White	<b>8688.0141</b>
Also: <b>individual sheaths and obturators</b>					
					
Individual sheath and obturator	SL/WL	Color coding	Product no.	Adapter for resectoscope	Working element, passive, mono 30°
<b>Sheath for resectoscope 9 FR</b>	SL 106 mm	White	<b>8688.0145</b>	for diagnostics and probing	Receptacle for stricture scalpels
<b>Obturator for resectoscope 9 FR</b>	WL 123 mm	White	<b>8688.0147</b>	<b>8688.264</b>	<b>8688.224</b>
Also: 					
PANOVIEW telescope	Direction of view	Ø	WL	TL	Product no.
<b>Telescope 0° Ø 1.9 mm WL 178 mm</b>	0°	1.9 mm	178 mm	243 mm	<b>8686.414</b>



Recommended accessories	Product no.
<b>Perforated basket for standard telescope 1</b>	Internal dimensions (W x H x D): 270 x 52 x 40 mm External dimensions (W x H x D): 297 x 54 x 59 mm <b>38015</b>
<b>Fiber light cable bndl</b> consisting of: Fiber light cable (80662523), projector-side adapter (8095.07), and endoscope-side adapter (809509)	Ø 2.5 mm, 2.3 m long <b>806625231</b>
<b>Electrodes and scalpels</b>	<b>see URO182</b>
<b>HF connection cable</b>	<b>see URO103/104</b>

IX23 | Subject to modifications. Please note that some products may not be available in all countries. Please always take note of the information that is provided with the product. For more detailed information, please consult with your contact partner or directly with Richard Wolf GmbH.

*E-line*

# RESECTOSCOPE





FOR TELESCOPE 2.7 MM

FOR NEWBORNS AND INFANTS



6 o'clock cutting position

**AUTOCLAVE**  
**134° C / 273° F**

Sheath for cystoscope bndl	consisting of:			Fr	Color coding	Product no.
<b>Sheath for resectoscope 11.5 FR</b> with irrigation valve	Sheath for resectoscope 11.5 FR (8677.0145), obturator for resectoscope 11.5 FR (8677.0147), tube with LUER-LOCK connector (886.00)			11.5	Yellow	<b>8677.0141</b>
Also: individual sheaths and obturators						
						
Individual sheath and obturator	SL/WL	Color coding	Product no.	Adapter for urethrotome/ resectoscope	Working element, active, mono 0°	
<b>Sheath for resectoscope 11.5 FR</b>	SL 105 mm	Yellow	<b>8677.0145</b>	for diagnostics (without stopcock)	Receptacle for stricture scalpels	
<b>Obturator for resectoscope 11.5 FR</b>	WL 124 mm	Yellow	<b>8677.0147</b>	<b>8677.254</b>	<b>8677.224</b>	
Also: 						
PANOVIEW telescope			Ø	WL	TL	Product no.
Telescope 0° Ø 2.7 mm WL 182 mm			2.7 mm	182 mm	249 mm	<b>8672.421</b>



RESECTOSCOPES





3.7



Recommended accessories	Product no.
<b>Perforated basket for standard telescope 1</b>	Internal dimensions (W x H x D): 270 x 52 x 40 mm External dimensions (W x H x D): 297 x 54 x 59 mm <b>38015</b>
<b>Fiber light cable bndl</b> consisting of: Fiber light cable (80662523), projector-side adapter (8095.07), and endoscope-side adapter (809509)	Ø 2.5 mm, 2.3 m long <b>806625231</b>
<b>Electrodes and scalpels</b>	see UR0182
<b>HF connection cable</b>	see UR0103/104

IX23 || Subject to modifications. Please note that some products may not be available in all countries. Please always take note of the information that is provided with the product. For more detailed information, please consult with your contact partner or directly with Richard Wolf GmbH.

## ELECTRODES AND SCALPELS

FOR RESECTOSCOPE WITH TELESCOPE 1.9 MM AND 2.7 MM

Electrodes		for resectoscope with telescope		
		Loop	1.9 mm	2.7 mm
	Cutting electrode mono 9 FR 0°	Round	<b>8688.93</b>	
	Cutting electrode mono 11.5 FR 0°			<b>8416.03</b>
	Coag. electrode mono 9 FR 0°	Ball	<b>8688.91</b>	
	Coag. electrode mono 11.5 FR 0°			<b>8416.01</b>
	Hook electrode mono 9 FR 0°	Hook	<b>8688.95</b>	
	Hook electrode mono 11.5 FR 0°			<b>8416.09</b>
	Coag. electrode mono 9 FR 0° 90° angled retrograde	Ball	<b>8688.994</b>	

Scalpel, for cold cutting of urethral strictures		for resectoscope with telescope		
		Cutting edge	1.9 mm	2.7 mm
	Scalpel 9 FR ceramic, semi-circular	Semi-circular	<b>8693.961</b>	
	Scalpel 11.5 FR ceramic, semi-circular			<b>8677.961</b>
	Scalpel 8.5 FR, sickle-shaped	Sickle-shaped	<b>8693.93</b>	
	Scalpel 11.5 FR, sickle-shaped			<b>8677.93</b>
	Scalpel 8.5 FR, hook-shaped	Hook-shaped	<b>8688.94</b>	

IX23 || Subject to modifications. Please note that some products may not be available in all countries. Please always take note of the information that is provided with the product. For more detailed information, please consult with your contact partner or directly with Richard Wolf GmbH.

# MIDI-SIZE RESECTOSCOPE

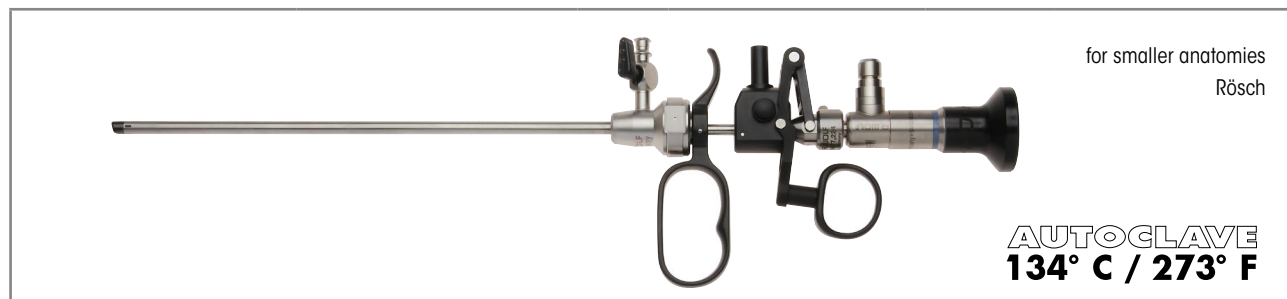

	consisting of:	Product no.
<b>Sheath for resectoscope 14.5 FR</b> with irrigation valve	Sheath for resectoscope 14.5 FR (86770155), obturator for resectoscope 14.5 FR (86770157), tube with LUER-LOCK connector (886.00)	<b>86770151</b>

**Also: individual sheaths and obturators**



Individual sheath and obturator	SL/WL	Color coding	Product no.	Working element, active, mono 0°
<b>Sheath for resectoscope 14.5 FR</b>	SL 221 mm	White	<b>86770155</b>	<b>8677.224</b>
<b>Obturator for resectoscope 14.5 FR</b>	WL 240 mm	White	<b>86770157</b>	

**Also:**



PANOVIEW telescope	Ø	WL	TL	Product no.
Telescope 0° Ø 2.7 mm WL 267 mm	2.7 mm	267 mm	334 mm	<b>8672430</b> 



Recommended accessories	Product no.
<b>Perforated basket for standard telescope 2</b>	Internal dimensions (W x H x D): 454 x 52 x 40 mm External dimensions (W x H x D): 481 x 54 x 59 mm <b>38016</b>
<b>Fiber light cable bndI</b> consisting of: Fiber light cable (80662523), projector-side adapter (8095.07), and endoscope-side adapter (809509)	Ø 2.5 mm, 2.3 m long <b>806625231</b>
<b>Container (W x H x D) 300 x 60 x 200 mm</b>	<b>33020</b>
<b>Monopolar connection cable</b>	see URO103/104



MIDI-SIZE RESECTOSCOPE  
3.8

IX23 || Subject to modifications. Please note that some products may not be available in all countries. Please always take note of the information that is provided with the product. For more detailed information, please consult with your contact partner or directly with Richard Wolf GmbH.

## MIDI-SIZE

### AUXILIARY INSTRUMENTS FOR THE MIDI-SIZE RESECTOSCOPE

Stricture scalpels with ceramic cutter		Cutting surface	Product no.
	<b>Scalpel 14.5 FR, lancet-shaped</b>	Lancet-shaped, cuts on both sides	<b>8677981</b>
	<b>Scalpel 14.5 FR, sickle-shaped</b>	Sickle-shaped	<b>8677931</b>

Electrodes		Electrode shape	Product no.
	<b>Coag. electrode mono 14.5 FR 0°</b> Stem color yellow	Button	<b>8416011</b>
	<b>Cutting electrode mono 14.5 FR 0°</b> Stem color yellow	Round loop	<b>8416031</b>
	<b>Hook electrode mono 14.5 FR 0°</b> Stem color yellow	Hook	<b>8416091</b>

IX23 || Subject to modifications. Please note that some products may not be available in all countries. Please always take note of the information that is provided with the product. For more detailed information, please consult with your contact partner or directly with Richard Wolf GmbH.



*E-line*

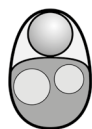

# ULTRA-THIN FIBER URETERORENOSCOPE

WITH LATERAL EYEPIECE

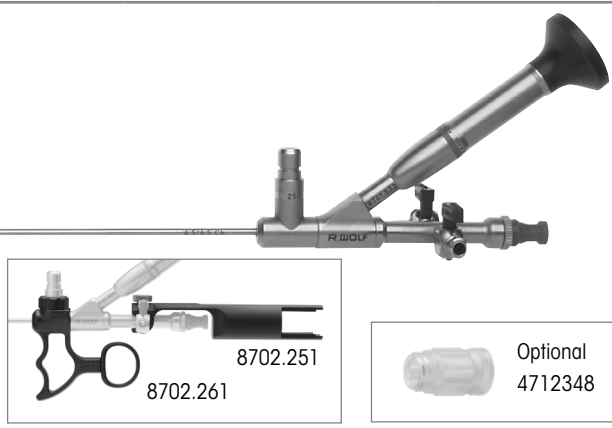

**AUTOCLAVE**  
**134° C / 273° F**

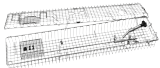

	WL	TL	Direction of view	Fr	Working channel	Product no.
<b>Ureterorenoscope 5°</b> <b>4.5/6.5 FR WL 430 mm</b> Atraumatically shaped tip	430 mm	555 mm	5°	4.5/6.5 Fr	3 Fr	<b>8701.534</b>
<b>Recommended accessories</b>						<b>Product no.</b>
	Flex. grasping forceps 3 FR WL 530 mm					<b>828.605</b>
	Flex. biopsy forceps 3 FR WL 530 mm					<b>829.603</b>
	Laser fiber Ø 200 µm, disposable					<b>487501200</b>
	Laser fiber Ø 272 µm, disposable					<b>487501272</b>
	Laser fiber Ø 200 µm, reusable					<b>87501200</b>
	Laser fiber Ø 272 µm, reusable					<b>87501272</b>
<b>Handle for E-Line ureterorenoscopes</b>						<b>8702.261</b>
<b>Guide element for ureterorenoscope for LITHOCLAST handpieces</b>						<b>8702.251</b>
for inserting auxiliary instruments of 1–6 FR: <b>universal sealing valve 1–6 FR, sterile (PU = 5 PCS)</b>						<b>4712348</b>
<b>Membrane holder standard</b>						<b>15256.393</b>
<b>Membrane holder with Luer</b>						<b>15256.456</b>
<b>Seal Ø 7.5 mm (PU = 10 pcs)</b>						<b>89.101</b>
<b>LithoClast probe Ø 0.8 mm WL 605 mm</b>						<b>8742.001</b>
<b>Perforated basket, upper urinary tract 1</b> with small part basket			Internal dimensions (W x H x D): 619 x 65 x 124 mm External dimensions (W x H x D): 635 x 75 x 132 mm			<b>38003</b>
<b>Marking pen, black</b>						<b>38201.948</b>
<b>Fiber light cable bndl</b> consisting of: Fiber light cable (80662523), projector-side adapter (8095.07), and endoscope-side adapter (809509)			Ø 2.5 mm, 2.3 m long			<b>806625231</b>
<b>Auxiliary instruments</b>						<b>see UR0197</b>

FIBER URETERORENOSCOPE

3.9

IX23 || Subject to modifications. Please note that some products may not be available in all countries. Please always take note of the information that is provided with the product. For more detailed information, please consult with your contact partner or directly with Richard Wolf GmbH.





**AUXILIARY INSTRUMENTS**

## AUXILIARY INSTRUMENTS

4.1

---

**BLADDER SYRINGES**

---

4.2

**SEALING CAPS**

---

4.3

**LUER-LOCK PARTS / STOPCOCKS AND IRRIGATION ADAPTERS /  
SEALING VALVE / ADAPTER / LASER ADJUSTMENT UNIT**

---

4.4

**FORCEPS AND SCISSORS, RIGID**

---

4.5

**FORCEPS AND SCISSORS, FLEXIBLE**

---

4.6

**ELECTRODES**

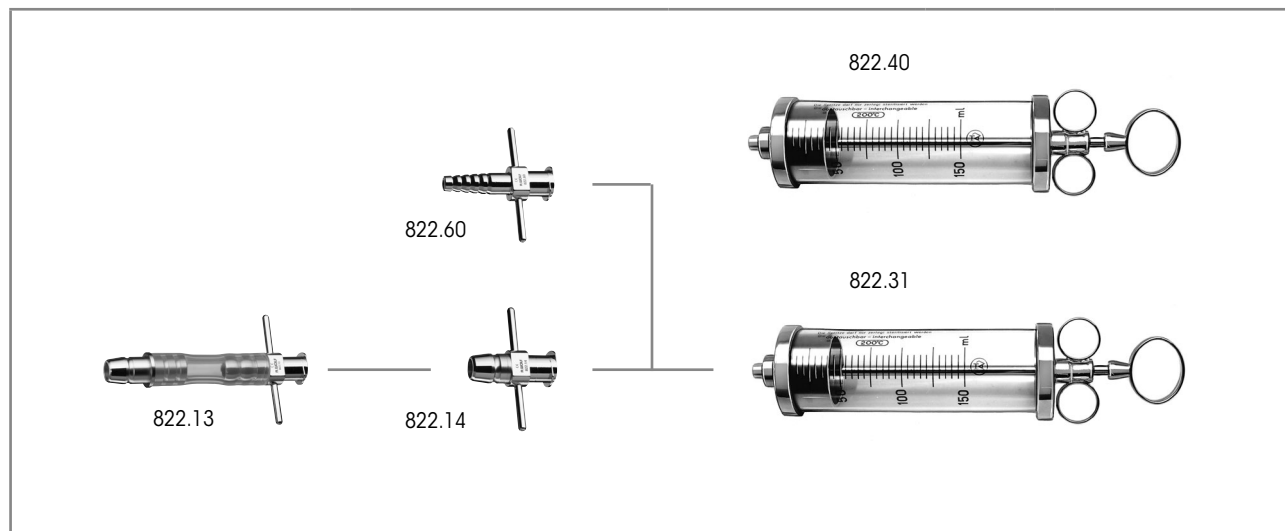

---

# BLADDER SYRINGES





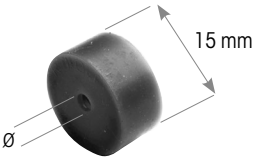
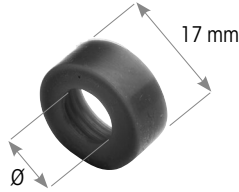
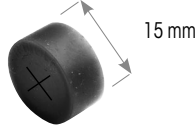
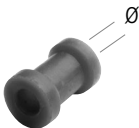







		Ø	ml	L/TL	Product no.
<b>Bladder syringe 150 ml Ø 54 mm</b>	for flexible and rigid adapters	54 mm	150 ml	L 248 mm	<b>822.31</b>
<b>Flexible adapter for bladder syringe</b>	Compatible with bladder syringe 822.31			TL 106 mm	<b>822.13</b>
<b>Rigid adapter for bladder syringe</b>	Compatible with instruments with cone B and bladder syringe 822.31			TL 37 mm	<b>822.14</b>
<b>Bladder syringe 150 ml Ø 54 mm</b>		54 mm	150 ml	L 248 mm	<b>822.40</b>
<b>Rigid adapter for bladder syringe</b>	Compatible with bladder syringe 822.40			TL 50 mm	<b>822.60</b>
<b>for bladder syringe 150 ml (822.31 and 822.40)</b>					
<b>Spare cylinder 150 ml</b>			150 ml		<b>82295</b>

# SEALING CAPS

Figure		Capacity Ø mm	Color	Product no.
<b>Sealing cap</b> Small, PU = 10 PCS 	<b>Sealing cap without hole</b>	-	Red-orange	<b>89.20</b>
	<b>Sealing cap capacity &lt; 2.4 mm</b>	< 2.4	Black	<b>89.00</b>
	<b>Sealing cap capacity 2.4–3.4 mm</b>	2.4–3.4	Red	<b>89.01</b>
	<b>Sealing cap capacity 3.4–5.1 mm</b>	3.4–5.1	Blue	<b>89.02</b>
	<b>Sealing cap capacity 5.1–6.0 mm</b>	5.1–6.0	Gray	<b>89.03</b>
	<b>Sealing cap capacity 6.0–7.0 mm</b>	6.0–7.0	Brown	<b>89.04</b>
	<b>Sealing cap capacity 6.0–7.0 mm</b>	7.0–8.0	Yellow	<b>89.05</b>
	<b>Sealing cap capacity 9.5–10.1 mm</b>	9.5–10.1	Red	<b>89.08</b>
	<b>Sealing cap capacity &gt; 10.1 mm</b>	> 10.1	Blue	<b>89.09</b>
	<b>Sealing cap capacity 13.0–13.8 mm</b>	13.0–13.8	Red	<b>89.10</b>
	<b>Sealing cap capacity 4–6 mm</b>	4.0–6.0	Red	<b>89.141</b>
	<b>Sealing cap capacity 7.5–8.5 mm</b>	7.5–8.5	Blue	<b>89.161</b>
	<b>Sealing cap capacity 7.0 mm</b>	7.0	Brown	<b>89.171</b>
<b>Sealing cap with cross-shaped slot</b> 	for trocar sleeve with threaded sheath, PU = 10 PCS	-	Red-orange	<b>89.90</b>
<b>RIWO rubber cap</b> PU = 10 PCS 	<b>RIWO rubber cap without hole</b>	-	Red-orange	<b>88.00</b>
	<b>RIWO rubber cap capacity 0.5 mm</b>	0.5	Red	<b>88.005</b>
	<b>RIWO rubber cap capacity 0.8 mm</b>	0.8	Red-orange	<b>88.01</b>
	<b>RIWO rubber cap capacity 1.4 mm</b>	1.4	Blue	<b>88.02</b>
	<b>RIWO rubber cap capacity 2.4 mm</b>	2.4	Black	<b>88.03</b>
	<b>RIWO rubber cap capacity 4.0 mm</b>	4.0	Green	<b>88.04</b>
	<b>Rubber cap for hysteroscope</b> Extended, PU = 1 PC	-	Red-orange	<b>18.01</b>



## LUER-LOCK PARTS / STOPCOCKS AND IRRIGATION ADAPTERS / SEALING VALVE / ADAPTER/LASER ADJUSTMENT UNIT

		Hole		Product no.
	<b>Tube with LUER-LOCK connector</b>	Ø 3 mm	Male	<b>886.00</b>
	<b>Tube with LUER-LOCK connector Ø 4 mm</b> Length 29.5 mm	Ø 4 mm	Male	<b>886.01</b>
	<b>Tube with LUER-LOCK connector Ø 3 mm</b> Length 28 mm	Ø 3 mm	Female	<b>891.00</b>
	<b>Tube with LUER-LOCK connector,</b> <b>891.011</b>	Ø 4 mm	Female	<b>15023.041</b>
	<b>Stopcock LUER-LOCK connection</b> <b>Ø 3 mm</b>	Ø 3 mm	Male	<b>884.00</b>
	<b>Stopcock LUER-LOCK connection</b> <b>Ø 4 mm</b>	Ø 4 mm	Male	<b>884.01</b>
	<b>Two-way stopcock, maintenance-free</b> with LUER-LOCK connection	Ø 3 mm	Male	<b>88350</b>
	<b>Two-way stopcock, maintenance-free</b> with LUER-LOCK connection	Ø 4 mm	Female	<b>88351</b>
	<b>Adapter</b> with 2 Luer connections, male, quick-release mechanism, TL 36 mm			<b>7305.781</b>
	<b>Adapter</b> with 2 irrigation valves and 1 instrument port, quick-release mechanism			<b>7305.782</b>
	Also: <b>Luer sealing cap</b>			<b>15023205</b>
	<b>Universal sealing valve 1–6 FR</b> for inserting auxiliary instruments of 1–6 Fr			<b>4712348</b>
	<b>Adapter</b> for machine leakage tests			<b>163.905</b>
	<b>Laser adjustment unit bndl</b>			<b>15369108</b>
	Also: <b>clamping element, orange (20 pcs)</b>			<b>15394144</b>

# RIGID FORCEPS AND SCISSORS

SMALL MODULAR SYSTEM **HySafe**

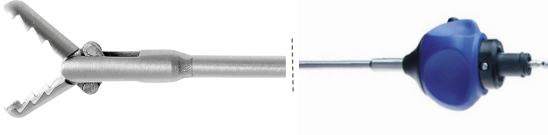
RECOMMENDED FOR CYSTOSCOPY

Grasping forceps jaw insert with sheath				Handle with overload protection	Complete instrument
					<ul style="list-style-type: none"> <li>Jaw section</li> <li>Handle</li> </ul>
	Product no.	Fr	WL	8083.001	Product no.
<b>Grasping forceps bndl</b> Distal angled with pike-mouth jaws	8642.6508	5	340 mm	•	<b>8642.6502</b>
	8645.6508	7	325 mm	•	<b>8645.6502</b>
<b>Grasping forceps bndl</b> - Spoon	8642.6008	5	340 mm	•	<b>8642.6002</b>
	8645.6008	7	340 mm	•	<b>8645.6002</b>
<b>Biopsy forceps bndl</b>	8642.6318	5	340 mm	•	<b>8642.6312</b>
<b>Scissors bndl</b>	8642.6818	5	340 mm	•	<b>8642.6812</b>
<b>Hook scissors bndl</b> Through-cutting	8992.6408	7	310 mm	•	<b>8992.6402</b>



IX23 || Subject to modifications. Please note that some products may not be available in all countries. Please always take note of the information that is provided with the product. For more detailed information, please consult with your contact partner or directly with Richard Wolf GmbH.



# RIGID FORCEPS AND SCISSORS

## SMALL MODULAR SYSTEM **HySafe**

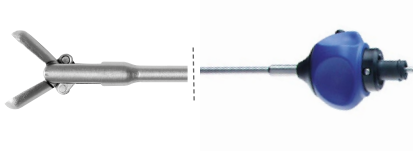
### RECOMMENDED FOR URETERORENOSCOPY







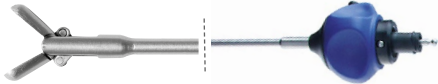

Grasping forceps jaw insert with sheath				Handle with overload protection	Complete instrument
					<ul style="list-style-type: none"> <li>Jaw section</li> <li>Handle</li> </ul>
	Product no.	Fr	WL	8083.001	Product no.
<b>Biopsy forceps bndl</b>	8952.6008	5	550 mm	•	<b>8952.6002</b>
<b>Grasping forceps bndl with mouse tooth</b>	8952.6118	4	550 mm	•	<b>8952.6112</b>
	8959.6218	5	425 mm	•	<b>8959.6212</b>
	8952.6218	5	550 mm	•	<b>8952.6212</b>
<b>Grasping forceps bndl</b>	8959.6808	5	425 mm	•	<b>8959.6802</b>
	8954.6808	5	550 mm	•	<b>8954.6802</b>
<b>Grasping forceps bndl with pike-mouth jaws, short</b>	8952.6508	5	550 mm	•	<b>8952.6502</b>

IX23 || Subject to modifications. Please note that some products may not be available in all countries. Please always take note of the information that is provided with the product. For more detailed information, please consult with your contact partner or directly with Richard Wolf GmbH.

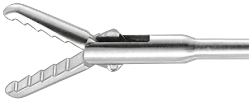
# RIGID FORCEPS AND SCISSORS

SMALL MODULAR SYSTEM **HySafe**

RECOMMENDED FOR NEPHROSCOPY

Grasping forceps jaw insert with sheath				Handle with overload protection	Complete instrument • Jaw section • Handle
					
	Product no.	Fr	WL	8083.001	Product no.
<b>Grasping forceps bndl</b> Pike-mouth jaws 	8962.6008	10.5 Fr	350 mm	•	<b>8962.6002</b>
	8962.6048	12 Fr	355 mm	•	<b>8962.6042</b>
<b>Grasping forceps bndl</b> Distal angled Pike-mouth jaws 	8962.6028	9 Fr	355 mm	•	<b>8962.6022</b>
<b>Grasping forceps bndl</b> Pike-mouth jaws 	8962.6108	10.5 Fr	350 mm	•	<b>8962.6102</b>
<b>Grasping forceps bndl</b> Peanut shape, fine toothing 	8962.6078	12 Fr	340 mm	•	<b>8962.6072</b>
<b>Grasping forceps bndl</b> Mouse tooth 	8962.6058	12 Fr	340 mm	•	<b>8962.6052</b>
<b>Grasping forceps bndl</b> Pike-mouth jaws 	8962.6808	6 Fr	425 mm	•	<b>8968.6802</b>





IX23 || Subject to modifications. Please note that some products may not be available in all countries. Please always take note of the information that is provided with the product. For more detailed information, please consult with your contact partner or directly with Richard Wolf GmbH.

## RIGID FORCEPS AND SCISSORS RECOMMENDED FOR NEPHROSCOPY

		Area of application	Fr	WL	Product no.
 Fine toothings	<b>Rigid grasping forceps 5 FR WL 340 mm</b>	Surgical urethro-cystoscopy for infants	5	340 mm	<b>8626.65</b>
 Serrated	<b>Biopsy forceps WL 270 mm</b>	Intrarenal stone surgery	8	270 mm	<b>8280.22</b>
	<b>Biopsy forceps WL 270 mm</b>	Intrarenal stone surgery	6	270 mm	<b>8280.23</b>
	<b>Scissors WL 230 mm</b>	Intrarenal stone surgery	8	230 mm	<b>8283.21</b>

# FLEXIBLE FORCEPS AND SCISSORS

RECOMMENDED FOR CYSTOSCOPY

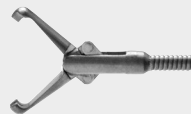
		Fr	WL	TL	Product no.
	Flex. grasping forceps 3 FR WL 230 mm	3	230 mm	380 mm	<b>828.03</b>
	Flex. grasping forceps 5 FR WL 315 mm	5	315 mm	465 mm	<b>828.05</b>
	Flex. grasping forceps 7 FR WL 365 mm	7	365 mm	515 mm	<b>828.07</b>
	Flex. grasping forceps 10 FR WL 325 mm	10	325 mm	475 mm	<b>828.10</b>
	Flex. grasping forceps 5 FR WL 550 mm	5	550 mm	720 mm	<b>828.051</b>
	Flex. biopsy forceps 3 FR WL 230 mm	3	230 mm	380 mm	<b>829.03</b>
	Flex. biopsy forceps 5 FR WL 315 mm	5	315 mm	465 mm	<b>829.05</b>
	Flex. biopsy forceps 7 FR WL 375 mm	7	375 mm	490 mm	<b>829.07</b>
	Flex. biopsy forceps 10 FR WL 325 mm	10	325 mm	475 mm	<b>829.10</b>
	Flex. biopsy forceps 5 FR WL 550 mm	5	550 mm	720 mm	<b>829.051</b>
	Flex. scissors 7 FR WL 375 mm	7	375 mm	490 mm	<b>830.07</b>
 Mouse tooth	Flex. grasping forceps 5 FR WL 550 mm	5	550 mm	680 mm	<b>8735.685</b>
	Flex. grasping forceps 6.6 FR WL 550 mm	6.6	550 mm	690 mm	<b>8736.685</b>

## FLEXIBLE FORCEPS AND SCISSORS RECOMMENDED FOR URETERORENOSCOPY



		Fr	WL	TL	Product no.
	Flex. grasping forceps 3 FR WL 530 mm	3	530 mm	665 mm	<b>828.605</b>
	Flex. grasping forceps 5 FR WL 550 mm	5	550 mm	720 mm	<b>828.051</b>
 Fine toothing	Flex. grasping forceps 3 FR WL 920 mm	3	920 mm	1,050 mm	<b>828.651</b>
	Flex. biopsy forceps 5 FR WL 550 mm	5	550 mm	720 mm	<b>829.051</b>
	Flex. biopsy forceps 3 FR WL 530 mm	3	530 mm	665 mm	<b>829.603</b>
	Flex. biopsy forceps Ø 3 FR WL 920 mm	3	920 mm	1,055 mm	<b>829.601</b>
	Flex. biopsy forceps 4 FR WL 600 mm	4	600 mm	730 mm	<b>8734.606</b>
 Pike-mouth jaws	Flex. grasping forceps 4 FR WL 600 mm	4	600 mm	750 mm	<b>8734.656</b>
 Mouse tooth	Flex. grasping forceps 4 FR WL 600 mm	4	600 mm	750 mm	<b>8734.686</b>
	Flex. grasping forceps 5 FR WL 550 mm	5	550 mm	700 mm	<b>8735.685</b>
	Flex. grasping forceps 3.5 FR WL 550 mm, Fine toothing	3.5	550 mm	700 mm	<b>8953.60</b>

# FLEXIBLE FORCEPS AND SCISSORS

RECOMMENDED FOR NEPHROSCOPY

		Fr	WL	TL	Product no.
	Flex. grasping forceps 3 FR WL 530 mm	3	530 mm	665 mm	<b>828.605</b>
	Flex. grasping forceps 5 FR WL 550 mm	5	550 mm	720 mm	<b>828.051</b>
	Flex. biopsy forceps 5 FR WL 550 mm	5	550 mm	720 mm	<b>829.051</b>
 Mouse tooth	Flex. grasping forceps 5 FR WL 550 mm	5	550 mm	680 mm	<b>8735.685</b>
	Flex. grasping forceps 6.6 FR WL 550 mm	6.6	550 mm	690 mm	<b>8736.685</b>

# ELECTRODES

		Area of applica- tion	Electrode shape	WL	Fr	Product no.
	<b>Coag. electrode mono 5 FR WL 600 mm</b>	Ureterorenoscopy	Button	600 mm	5	<b>8599.80</b>
	<b>Coag. electrode mono 4 FR WL 400 mm</b>	Cystoscopy	Button	400 mm	4	<b>823.04</b>
	<b>Coag. electrode mono 5 FR WL 400 mm</b>				5	<b>823.05</b>
	<b>Coag. electrode mono 6 FR WL 400 mm</b>				6	<b>823.06</b>
	<b>Coag. electrode mono 10 FR WL 400 mm</b>				10	<b>823.10</b>
	<b>Coag. electrode mono 3 FR WL 580 mm</b>	Ureterorenoscopy	Button	580 mm	3	<b>823.031</b>
	<b>Hook electrode mono 2.4 FR WL 600 mm</b>	Ureterorenoscopy	Hook	600 mm	2.4	<b>823.221</b>

ELECTRODES

4.6

IX23 || Subject to modifications. Please note that some products may not be available in all countries. Please always take note of the information that is provided with the product. for more detailed information, please consult with your contact partner or directly with Richard Wolf GmbH.





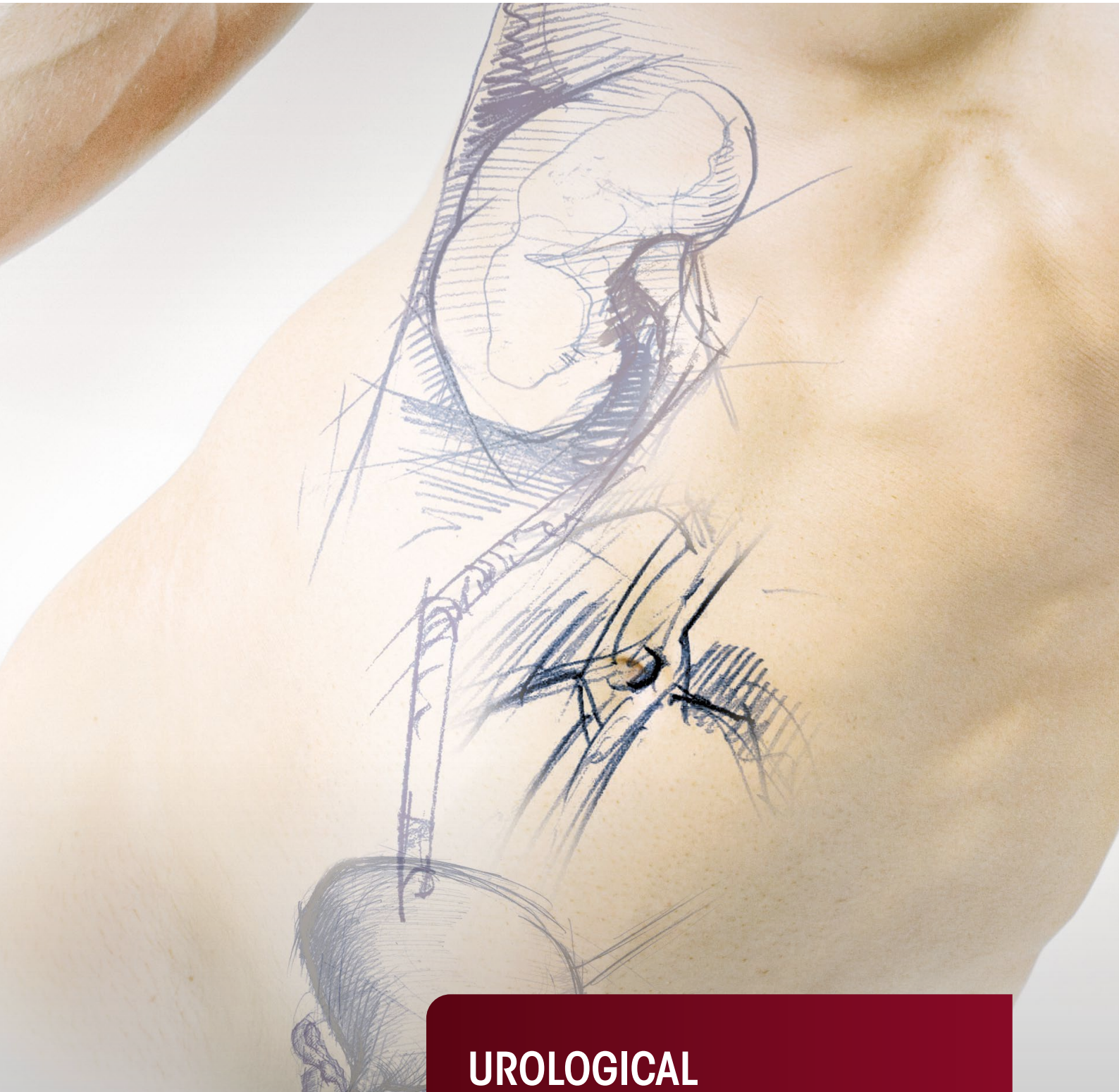

**UROLOGICAL  
LAPAROSCOPY**

## UROLOGICAL LAPAROSCOPY

1

**BASIC SETS**

2

**TELESCOPES**

3

**TROCAR SLEEVES/DILATION/EXTRACTION/REDUCING SLEEVES**

4

**ERAGONMODULAR GRASPING FORCEPS/DISSECTORS/BIOPSY FORCEPS/SCISSORS**

5

**GRASPING FORCEPS**

6

**BIPOLAR FORCEPS AND SCISSORS**

7

**HF ELECTRODES (MONOPOLAR/BIPOLAR)**

8

**MULTIFUNCTIONAL SUCTION IRRIGATION SYSTEM**

9

**TISSUE RETRACTOR**

10

**CLIP APPLICATOR**

11

**NEEDLE HOLDER/KNOT PUSHER/FASCIA CLOSURE**

12

**CANNULAS/SURGICAL PROBES/MYOMA DRILLS**

13

**DEVICES/ACCESSORIES**

14

**CHOLEDOCHOSCOPY**

15

**TRAINING MODELS**

## BASIC SET

### FOR ALL LAPAROSCOPIC PROCEDURES

Product	Product no.	Quantity	Catalog / Section
Insufflator 45 EVAC + HEAT bndl	<b>22350311</b>	1	Laparoscopy / 14
VERES cannula Ø 2.1 mm WL 152 mm	<b>8302.12</b>	1	Laparoscopy / 3
LAP suction irrigation pump bndl	<b>22160011</b>	1	Laparoscopy / 14
LED light source ENDOLIGHT LED 2.1 bndl	<b>51630011</b>	1	Imaging / Light sources
Fiber light cable		1	Imaging / Light cables
ENDOCAM Logic HD	<b>5525</b>	1	Imaging / ENDOCAM
Monitors		1	Imaging / Monitors
Device cart		1	Imaging / Device cart

## BASIC SET

### FOR LAPAROSCOPIC CHOLECYSTECTOMY

Product	Product no.	Quantity	Catalog / Section
Telescope 30° Ø 10 mm WL 307 mm	<b>8934.432</b>	1	Laparoscopy / 2
and/or			
Telescope 0° Ø 10 mm WL 307 mm	<b>8934.431</b>	1	Laparoscopy / 2
Fiber light cable bndl	<b>806650231</b>	1	Laparoscopy / 2
Trocar sleeve, slanted, capacity 5.5 mm WL 100 mm	<b>8921.013</b>	2-3	Laparoscopy / 3
and/or			
Trocar sleeve, straight, capacity 5.5 mm WL 102 mm	<b>8919.351</b>	2-3	Laparoscopy / 3
Trocar sleeve, slanted, capacity 10 mm WL 100 mm	<b>8923.013</b>	2	Laparoscopy / 3
Guide rod 5.5 mm TL 500 mm	<b>8923.921</b>	1	Laparoscopy / 3
Instrument sleeve 10 mm WL 170 mm	<b>8385.50</b>	1	Laparoscopy / 3
VERES cannula Ø 2.1 mm WL 152 mm	<b>8302.12</b>	1	Laparoscopy / 3
Multifunctional suction irrigation system			
Suction irrigation tube Ø 5 mm WL 310 mm	<b>8383.911</b>	1	Laparoscopy / 8
Suction irrigation handle	<b>8385.901</b>	1	Laparoscopy / 8
Sealing cap	<b>8385.902</b>	1	Laparoscopy / 8
<b>ERAGONmodular</b>			
Atraumatic grasping forceps Ø 5 mm bndl	<b>83932925</b>	1	Laparoscopy / 4
Atraumatic grasping forceps mono Ø 5 mm bndl	<b>83931817</b>	2	Laparoscopy / 4
Maryland dissector forceps mono Ø 5 mm bndl	<b>83932817</b>	1	Laparoscopy / 4
Metzenbaum scissors Ø 5 mm bndl	<b>83930417</b>	1	Laparoscopy / 4
Grasping forceps Ø 10 mm bndl	<b>83952048</b>	1	Laparoscopy / 4
Plate-shaped grasping forceps Ø 10 mm bndl	<b>83952347</b>	1	Laparoscopy / 4
<b>Hook electrode mono Ø 5 mm WL 340 mm</b>			
Clip applicator Ø 10 mm WL 340 mm	<b>8389.911</b>	1	Laparoscopy / 10
Ethicon® Ligaclips® (PACK= 108 PCS)	<b>8389.915</b>	1	Laparoscopy / 10
Needle forceps Ø 2.45 mm WL 160 mm	<b>8756.201</b>	1	Laparoscopy / 11
Sealing cone Ø 12-15 mm	<b>8943.915</b>	1	Laparoscopy / 11
Monopolar HF cable	<b>8106</b>	2	Laparoscopy / 14

# BASIC SET

## FOR LAPAROSCOPIC CHOLECYSTECTOMY

Product	Product no.	Quantity	Catalog / Section
Also on request:			
Telescope 30° Ø 5.3 mm WL 303 mm	<b>8935442</b>	1	Laparoscopy / 2
Trocar sleeve, slanted, capacity 5.5 mm WL 100 mm	<b>8921.013</b>	1	Laparoscopy / 3
Trocar tip sharp size 5.5 mm WL 169 mm	<b>8921.113</b>	1	Laparoscopy / 3
ERAGONmodular			
Atraumatic grasping forceps mono Ø 5 mm bndl	<b>83931957</b>	1	Laparoscopy / 4
Biopsy forceps mono Ø 5 mm bndl	<b>83930937</b>	1	Laparoscopy / 4
Dissector forceps Ø 10 mm bndl	<b>83952268</b>	1	Laparoscopy / 4
ERAGONbipolar			
Grasping forceps bipo Ø 5.5 mm bndl	<b>839300312</b>	1	Laparoscopy / 6

In addition to laparoscopic choledochus revision			
Grasping forceps Ø 5 mm WL 295 mm	<b>8383311</b>	1	Laparoscopy / 5

## BASIC SET

### FOR LAPAROSCOPIC APPENDECTOMY

Product	Product no.	Quantity	Catalog / Section
Telescope 30° Ø 10 mm WL 307 mm	<b>8934.432</b>	1	Laparoscopy / 2
and/or			
Telescope 0° Ø 10 mm WL 307 mm	<b>8934.431</b>	1	Laparoscopy / 2
Fiber light cable bndl	<b>806650231</b>	1	Laparoscopy / 2
Trocar sleeve, slanted, capacity 10 mm WL 100 mm	<b>8923.013</b>	2	Laparoscopy / 3
Trocar tip sharp size 10 mm	<b>8923.113</b>	2	Laparoscopy / 3
and/or			
Trocar sleeve, straight, capacity 5.5 mm WL 102 mm	<b>8919.351</b>	2-3	Laparoscopy / 3
Trocar tip sharp size 5.5 mm WL 144 mm	<b>8919.3512</b>	2-3	Laparoscopy / 3
Trocar sleeve, slanted, capacity 5.5 mm WL 100 mm	<b>8921.013</b>	2-3	Laparoscopy / 3
Trocar tip sharp size 5.5 mm WL 169 mm	<b>8921.113</b>	2-3	Laparoscopy / 3
Guide rod 5.5 mm TL 500 mm	<b>8923.921</b>	1	Laparoscopy / 3
Instrument sleeve 10 mm WL 170 mm	<b>8385.50</b>	1	Laparoscopy / 3
<b>ERAGONmodular</b>			
Grasping forceps mono Ø 5 mm bndl	<b>83932877</b>	1	Laparoscopy / 4
Atraumatic grasping forceps mono Ø 5 mm bndl	<b>83931817</b>	2	Laparoscopy / 4
Maryland dissector forceps mono Ø 5 mm bndl	<b>83932817</b>	1	Laparoscopy / 4
Metzenbaum scissors Ø 5 mm bndl	<b>83930417</b>	1	Laparoscopy / 4
Grasping and dissector forceps 5 mm	<b>83932827</b>	1	Laparoscopy / 4
<b>ERAGONbipolar</b>			
Grasping forceps bipo Ø 5.5 mm bndl	<b>839300312</b>	1	Laparoscopy / 6
<b>Multifunctional suction irrigation system</b>			
Suction irrigation tube Ø 5 mm WL 310 mm	<b>83839.11</b>	1	Laparoscopy / 8
Suction irrigation handle	<b>8385.901</b>	1	Laparoscopy / 8
Sealing cap	<b>8385.902</b>	1	Laparoscopy / 8
<b>Surgical probe Ø 5 mm WL 328 mm</b>			
Surgical probe Ø 5 mm WL 328 mm	<b>8383.66</b>	1	Laparoscopy / 12
VERES cannula Ø 2.1 mm WL 152 mm	<b>8302.12</b>	1	Laparoscopy / 3
Bipolar HF cable	<b>8108</b>	1	Laparoscopy / 14
Monopolar HF cable	<b>8106</b>	1	Laparoscopy / 14

# BASIC SET

## FOR LAPAROSCOPIC APPENDECTOMY

Product	Product no.	Quantity	Catalog / Section
Also on request:			
ERAGONmodular			
Dissector forceps mono Ø 5 mm bndl	<b>83932897</b>	1	Laparoscopy / 4
Grasping forceps mono Ø 5 mm bndl	<b>83931837</b>	2	Laparoscopy / 4
Biopsy forceps mono Ø 5 mm bndl	<b>83930917</b>	1	Laparoscopy / 4
Maryland dissector forceps Ø 10 mm bndl	<b>83952257</b>	1	Laparoscopy / 4
Clip applicator Ø 10 mm WL 340 mm	<b>8389.911</b>	1	Laparoscopy / 10
Ethicon® Ligaclips® (PACK= 108 PCS)	<b>8389.915</b>	1	Laparoscopy / 10
Introduction sleeve 10 mm WL 80 mm	<b>8389.991</b>	1	Laparoscopy / 10
Needle holder Ø 5 mm bndl	<b>8393.502</b>	1	Laparoscopy / 11



## BASIC SET LEVD

### LAPAROSCOPIC SINGLE-CHANNEL VARICOCELE DISSECTION

Product	Product no.	Quantity	Catalog / Section
OR endoscope bndl	<b>8920.4011</b>	1	Laparoscopy / 2
Perforated basket for telescope	<b>38008</b>		Laparoscopy / 2
Fiber light cable bndl	<b>806625231</b>	1	Laparoscopy / 2
Trocar sleeve, straight, capacity 5.5 mm WL 102 mm	<b>8919.353</b>	1	Laparoscopy / 3
Optional:			
Trocar tip blunt size 5.5 mm WL 144 mm	<b>8919.3511</b>	1	Laparoscopy / 3
Trocar tip sharp size 5.5 mm WL 144 mm	<b>8919.3512</b>	1	Laparoscopy / 3
Trocar tip triangular size 5.5 mm WL 144 mm	<b>8919.3513</b>	1	Laparoscopy / 3
ERAGONmodular mini			
Universal grasping forceps Ø 3.5 mm bndl	<b>83912097</b>	1	Laparoscopy / 4
Atraumatic grasping forceps Ø 3.5 mm bndl	<b>83912087</b>	1	Laparoscopy / 4
Babcock forceps Ø 3.5 mm bndl	<b>83912107</b>	1	Laparoscopy / 4
Dissector forceps mono Ø 3.5 mm bndl	<b>83912077</b>	1	Laparoscopy / 4
Hook scissors mono Ø 3.5 mm bndl	<b>83912277</b>	1	Laparoscopy / 4
Metzenbaum scissors mono Ø 3.5 mm bndl	<b>83912247</b>	1	Laparoscopy / 4
Connection cable			
Bipolar HF cable	<b>8108</b>	1	Laparoscopy / 14
Monopolar HF cable	<b>8106</b>	1	Laparoscopy / 14



# BASIC SET

## E-MILOS

Product	Product no.	Quantity	Catalog / Section
Telescope 30° Ø 10 mm WL 307 mm	<b>8934.432</b>	1	Laparoscopy / 2
Light tube for MILOS method Ø 10 mm	<b>893420</b>	1	Laparoscopy / 2
Trocar sleeve, straight, capacity 3.5 mm WL 100 mm	<b>8903.014</b>	2	Laparoscopy / 3
Trocar tip blunt size 3.5 mm WL 169 mm	<b>8903.103</b>	2	Laparoscopy / 3
<b>ERAGONmodular mini</b>			
Handle, pistol-shaped, mono	<b>83930073</b>	4	Laparoscopy / 4
Sheath tube insulated Ø 3.5 mm SL 330 mm	<b>8391933</b>	4	Laparoscopy / 4
Dissector forceps insert Ø 3.5 mm	<b>8391222</b>	1	Laparoscopy / 4
Metzenbaum scissors insert Ø 3.5 mm	<b>8391215</b>	1	Laparoscopy / 4
Grasping forceps insert Ø 3.5 mm	<b>8391208</b>	2	Laparoscopy / 4
<b>Electrode</b>			
Hook electrode mono Ø 3.5 mm WL 310 mm	<b>8379.452</b>	1	Laparoscopy / 7
<b>ERAGONstitch</b>			
Needle holder insert Ø 3.5 mm	<b>8391506</b>	1	Laparoscopy / 11
Sheath tube Ø 3.5 mm SL 330 mm	<b>8391533</b>	1	Laparoscopy / 11
Needle holder handle, axial	<b>8393943</b>	1	Laparoscopy / 11

# BASIC SET

## MINI E-MILOS

Product	Product no.	Quantity	Catalog / Section
Telescope 30° Ø 10 mm WL 307 mm	<b>8934.432</b>	1	Laparoscopy / 2
Light tube for MILOS method Ø 10 mm	<b>893420</b>	1	Laparoscopy / 2
Trocar sleeve, straight, capacity 5.5 mm WL 100 mm	<b>8921.014</b>	2	Laparoscopy / 3
Trocar tip blunt size 5.5 mm WL 169 mm	<b>8921.103</b>	2	Laparoscopy / 3
<b>ERAGONmodular</b>			
Handle, pistol-shaped, mono	<b>83930073</b>	4	Laparoscopy / 4
Sheath tube insulated Ø 5 mm SL 330 mm	<b>8391933</b>	4	Laparoscopy / 4
Dissector forceps insert Ø 5 mm	<b>8393240</b>	1	Laparoscopy / 4
Metzenbaum scissors insert Ø 5 mm	<b>8393.041</b>	1	Laparoscopy / 4
Grasping forceps insert Ø 3.5 mm	<b>8393.181</b>	2	Laparoscopy / 4
<b>Electrode</b>			
Hook electrode mono Ø 5 mm WL 340 mm	<b>8383.423</b>	1	Laparoscopy / 7
<b>ERAGONstitch</b>			
Needle holder insert Ø 5 mm	<b>8393508</b>	1	Laparoscopy / 11
Sheath tube Ø 5 mm SL 330 mm	<b>8393533</b>	1	Laparoscopy / 11
Needle holder handle, axial	<b>8393943</b>	1	Laparoscopy / 11

# BASIC SET

## LAPAROSCOPIC BARIATRIC SURGERY

Product	Product no.	Quantity	Catalog / Section
Telescope 0° Ø 10 mm WL 305 mm	<b>8934461</b>	1	Laparoscopy / 2
Telescope 30° Ø 10 mm WL 305 mm	<b>8934462</b>	1	Laparoscopy / 2
Fiber light cable bndl	<b>806550231</b>	1	Laparoscopy / 2
Trocar sleeve, straight, capacity 5.5 mm WL 150 mm	<b>8921.016</b>	3	Laparoscopy / 3
Trocar sleeve, straight, capacity 10 mm WL 150 mm	<b>8923.016</b>	1	Laparoscopy / 3
Trocar sleeve, straight, capacity 12.5 mm WL 150 mm	<b>8924.016</b>	1	Laparoscopy / 3
<b>Optional:</b>			
Trocar tip sharp size 5.5 mm	<b>8921.115</b>	3	Laparoscopy / 3
Trocar tip sharp size 10 mm	<b>8923.115</b>	1	Laparoscopy / 3
Trocar tip sharp size 12.7 mm	<b>8924.115</b>	1	Laparoscopy / 3
Reducing adapter	<b>8923.802</b>	1	Laparoscopy / 3
<b>Multifunctional suction irrigation system</b>			
Suction irrigation tube Ø 5 mm WL 450 mm	<b>8384.911</b>	1	Laparoscopy / 8
Suction irrigation handle	<b>8385.901</b>	1	Laparoscopy / 8
Sealing cap	<b>8385.902</b>	1	Laparoscopy / 8
Suction irrigation tube set with piercing spike L 3 m	<b>4170.956</b>	1	Laparoscopy / 8
<b>ERAGONmodular</b>			
Atraumatic grasping forceps mono Ø 5 mm bndl	<b>83941817</b>	1	Laparoscopy / 4
Dissector forceps mono Ø 5 mm bndl	<b>83942407</b>	1	Laparoscopy / 4
Metzenbaum scissors mono Ø 5 mm bndl	<b>83940417</b>	1	Laparoscopy / 4
Atraumatic Grasping forceps Ø 5 mm bndl	<b>83942297</b>	1	Laparoscopy / 4
Biopsy forceps mono Ø 5 mm bndl	<b>83940917</b>	1	Laparoscopy / 4
Atraumatic Grasping forceps Ø 5 mm bndl	<b>83942507</b>	1	Laparoscopy / 4
Stapler head grasping forceps Ø 10 mm bndl	<b>83976558</b>	1	Laparoscopy / 4
Plate-shaped grasping forceps Ø 10 mm bndl	<b>83962347</b>	1	Laparoscopy / 4
Babcock forceps Ø 10 mm bndl	<b>83961877</b>	1	Laparoscopy / 4
<b>ERAGONbipolar</b>			
Maryland dissector bipo Ø 5.5 mm bndl	<b>839400322</b>	1	Laparoscopy / 6
Metzenbaum scissors bipo Ø 5.5 mm bndl	<b>839400412</b>	1	Laparoscopy / 6
<b>Electrode</b>			
Hook electrode mono Ø 5 mm WL 420 mm	<b>8384.423</b>	1	Laparoscopy / 7

## BASIC SET

### LAPAROSCOPIC BARIATRIC SURGERY

Product	Product no.	Quantity	Catalog / Section
Clip applicator Ø 10 mm WL 340 mm	<b>8389.911</b>	1	Laparoscopy / 10
Ethicon® Ligaclips® (PACK= 108 PCS)	<b>8389.915</b>	1	Laparoscopy / 10
Needle holder Ø 5 mm bndl with carbide insert	<b>8394.502</b>	1	Laparoscopy / 11
Needle holder Ø 5 mm bndl curved to the right with carbide insert	<b>8394.511</b>	1	Laparoscopy / 11
Needle forceps Ø 2.45 mm WL 160 mm	<b>8756.201</b>	1	Laparoscopy / 11
Sealing cone Ø 12–15 mm	<b>8943.915</b>	1	Laparoscopy / 11
Sealing cone Ø 10–12 mm	<b>8934.915</b>	1	Laparoscopy / 11
VERES cannula Ø 2.1 mm WL 152 mm	<b>8302.12</b>	1	Laparoscopy / 3
Handle, axial, mono	<b>83930084</b>	1	Laparoscopy / 14
Rotatable knob	<b>8988</b>	1	Laparoscopy / 14
Connection cable			
Mono HF connection cable L 3 m	<b>8106.033</b>	1	Laparoscopy / 13
Bipo HF connection cable L 3 m	<b>8108.132</b>	1	Laparoscopy / 13

# MINI FIBER TELESCOPES 2.0 MM

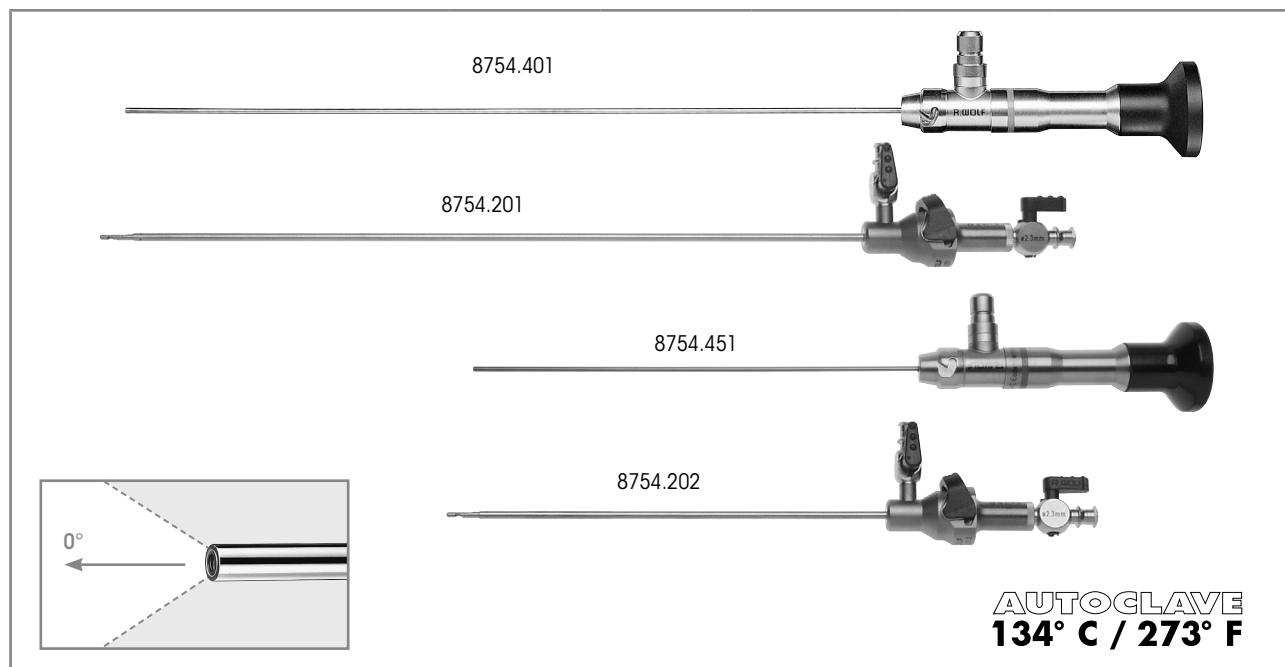

**AUTOCLAVE**  
**134° C / 273° F**

Long version	Direction of view	WL	TL	Ø	Product no.
Telescope 0° Ø 2 mm NL 268 mm	0°	268 mm	365 mm	2.0 mm	<b>8754.401</b>
<b>for this:</b>					
<b>VERES cannula Ø 2.3 mm WL 250 mm</b> consisting of: 1x VERES cannula Ø 2.3 mm WL 274 mm (8754.211) 1x outer sheath Ø 2.8 mm, WL 250 mm (8754.221)		250 mm		2.3 mm	<b>8754.201</b>
Short version	Direction of view	WL	TL	Ø	Product no.
Telescope 0° Ø 2 mm NL 158 mm	0°	158 mm	255 mm	2.0 mm	<b>8754.451</b>
<b>for this:</b>					
<b>VERES cannula Ø 2.3 mm WL 170 mm</b> consisting of: 1x VERES cannula Ø 2.3 mm WL 164 mm (8754.212) 1x outer sheath Ø 2.8 mm WL 141 mm (8754.222)		170 mm		2.3 mm	<b>8754.202</b>

Recommended accessories	Product no.
<b>Perforated basket for standard telescope 1</b> (for telescope 8754.451)	(W x H x D) 297 x 54 x 59 mm <b>38015</b>
<b>Perforated basket for standard telescope 2</b> (for telescope 8754.401)	(W x H x D) 481 x 54 x 59 mm <b>38016</b>
<b>Fiber light cable bndl</b> consisting of: Fiber light cable (80662523), projector-side adapter (8095.07), and endoscope-side adapter (809509)	Ø 2.5 mm, 2.3 m long <b>806625231</b>

11123 || Subject to modifications. Please note that some products may not be available in all countries. Please always take note of the information that is provided with the product. For more detailed information, please consult with your contact partner or directly with Richard Wolf GmbH.

# LAPAROSCOPES 3.5 MM

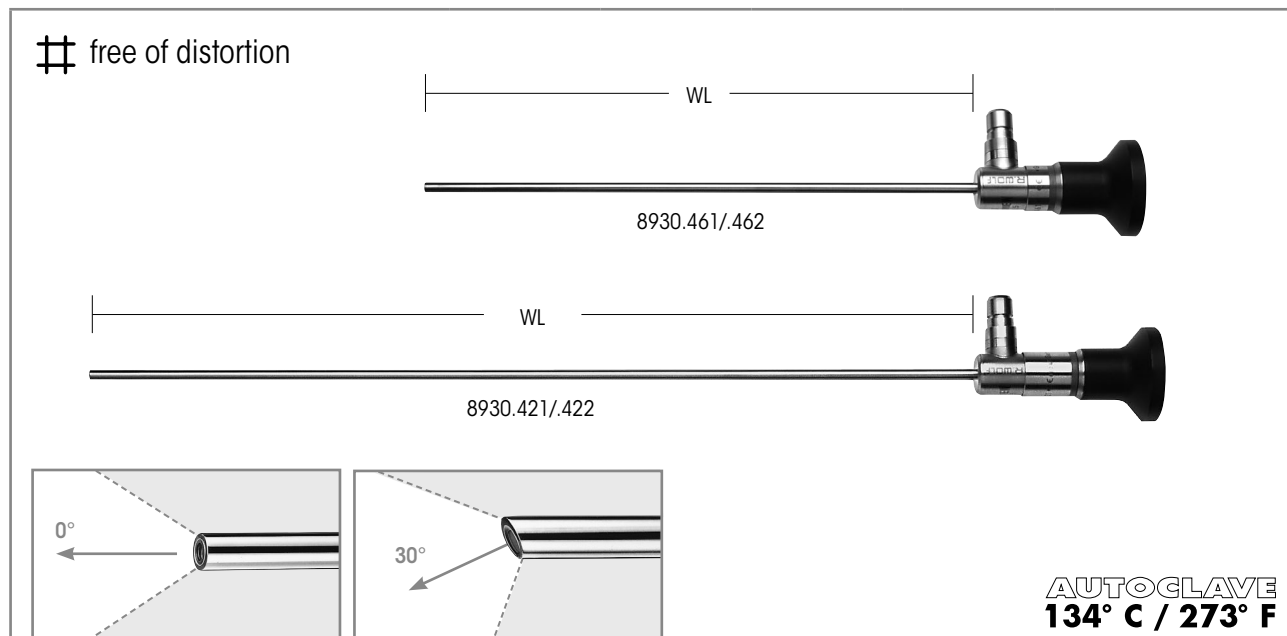

	Direction of view	WL	TL	Ø	Product no.
PANOVIEW PLUS Telescope 0° 3.5 mm WL 180 mm	0°	180 mm	232 mm	3.5 mm	<b>8930.461</b>
PANOVIEW PLUS Telescope 30° 3.5 mm WL 180 mm	30°		233 mm		<b>8930.462</b>
PANOVIEW PLUS Telescope 0° Ø 3.5 mm WL 300 mm	0°	300 mm	361 mm		<b>8930.421</b>
PANOVIEW PLUS Telescope 30° 3.5 mm WL 300 mm	30°		362 mm		<b>8930.422</b>

Recommended accessories		Product no.
<b>Perforated basket for standard telescope 1</b> (for telescope 8930.461/.462)	(W x H x D) 297 x 54 x 59 mm	<b>38015</b>
<b>Perforated basket for standard telescope 2</b> (for telescope 8930.421/.422)	(W x H x D) 481 x 54 x 59 mm	<b>38016</b>
<b>Fiber light cable bndl</b> consisting of: Fiber light cable (80662523), projector-side adapter (8095.07), and endoscope-side adapter (809509)	Ø 2.5 mm, 2.3 m long	<b>806625231</b>

III23 || Subject to modifications. Please note that some products may not be available in all countries. Please always take note of the information that is provided with the product. For more detailed information, please consult with your contact partner or directly with Richard Wolf GmbH.

# LAPAROSCOPES 5.3 MM

# free of distortion

full screen

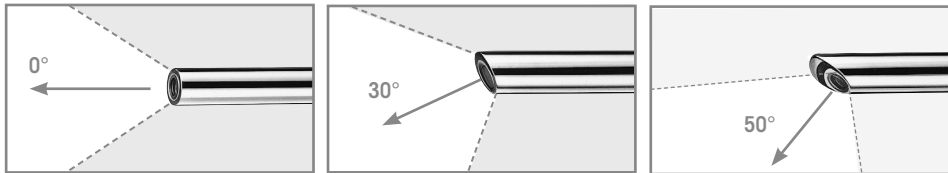
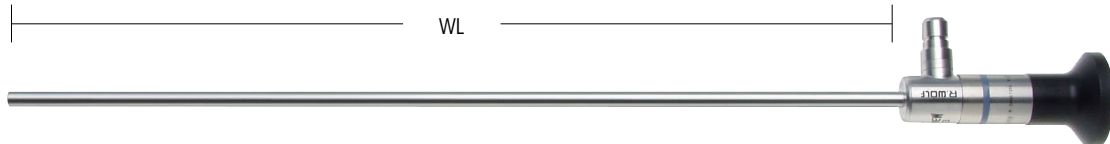

**AUTOCLAVE**  
**134° C / 273° F**

	Direction of view	WL	TL	Ø	Product no.
PANOVIEW Telescope 0° Ø 5.3 mm WL 303 mm	0°	303 mm	372 mm	5.3 mm	<b>8935.441</b>
PANOVIEW Telescope 30° Ø 5.3 mm WL 303 mm	30°		373 mm		<b>8935.442</b>
PANOVIEW Telescope 50° Ø 5.3 mm WL 309 mm	50°	309 mm	377 mm		<b>8935.443</b>

Recommended accessories		Product no.
<b>Perforated basket for standard telescope 2</b>	(W x H x D) 481 x 54 x 59 mm	<b>38016</b>
<b>Fiber light cable bndl</b> consisting of: Fiber light cable (80662523), projector-side adapter (8095.07), and endoscope-side adapter (809509)	Ø 2.5 mm, 2.3 m long	<b>806625231</b>

11123 || Subject to modifications. Please note that some products may not be available in all countries. Please always take note of the information that is provided with the product. For more detailed information, please consult with your contact partner or directly with Richard Wolf GmbH.

MINI OR LAPAROSCOPE  
5.5 MM WITH 3.5 MM WORKING CHANNEL

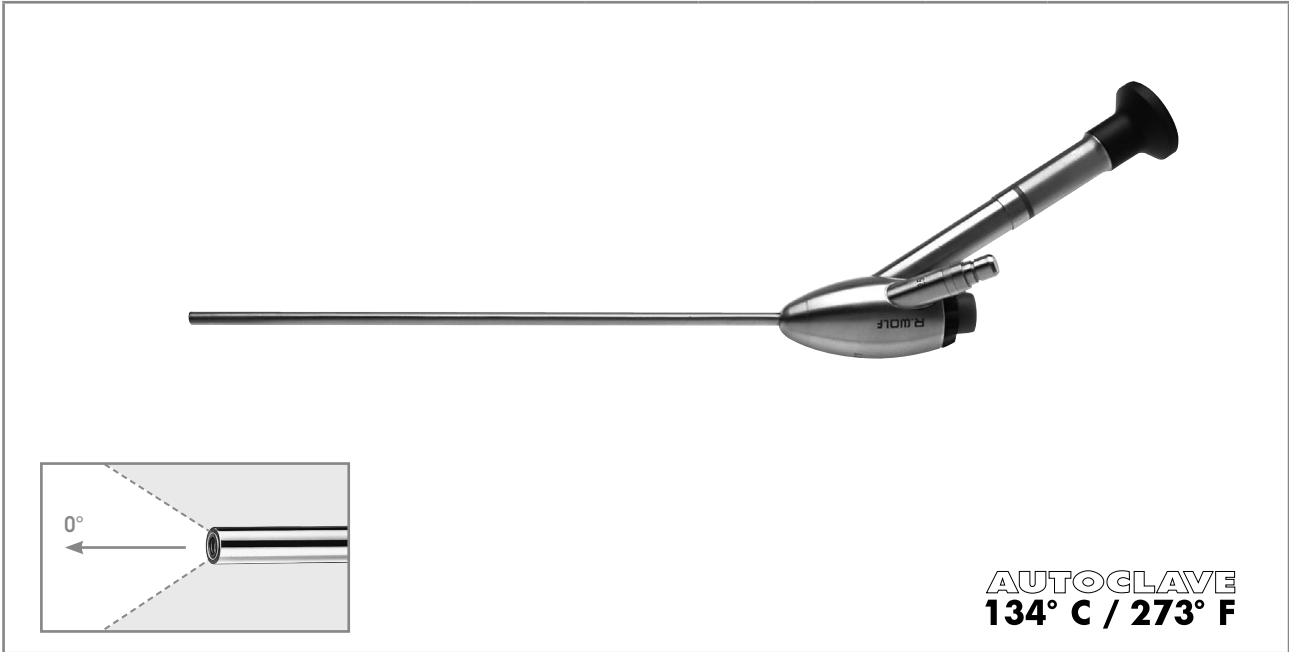

	Direction of view	SL	TL	Ø	Working channel Ø	Product no.
<b>OR endoscope bndl</b> consisting of: OR endoscope 0° Ø 5.5 mm SL 215 mm (8920.401) Autom. sealing element ID 5.7 mm (8920.311) Sealing cap, red-orange (15176.020) Sealing membrane Ø 17 mm (PACK= 10 PCS) (89.103)	0°	215 mm	370 mm	5.5 mm	3.5 mm	<b>8920.4011</b>

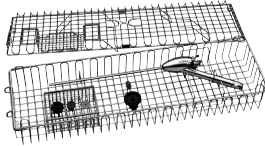
Recommended accessories		Product no.
Trocar sleeve, straight, capacity 5.5 mm WL 62 mm		<b>8919.333</b>
Trocar sleeve, straight, capacity 5.5 mm WL 102 mm		<b>8919.353</b>
<b>Perforated basket for telescope</b> Dimensions (W x L x H): 132 x 467 x 75 mm		<b>38008</b>
<b>Fiber light cable bndl</b> consisting of: Fiber light cable (80663523), projector-side adapter (8095.07), and endoscope-side adapter (809509)	Ø 3.5 mm, 2.3 m long	<b>806635231</b>

III23 || Subject to modifications. Please note that some products may not be available in all countries. Please always take note of the information that is provided with the product. For more detailed information, please consult with your contact partner or directly with Richard Wolf GmbH.



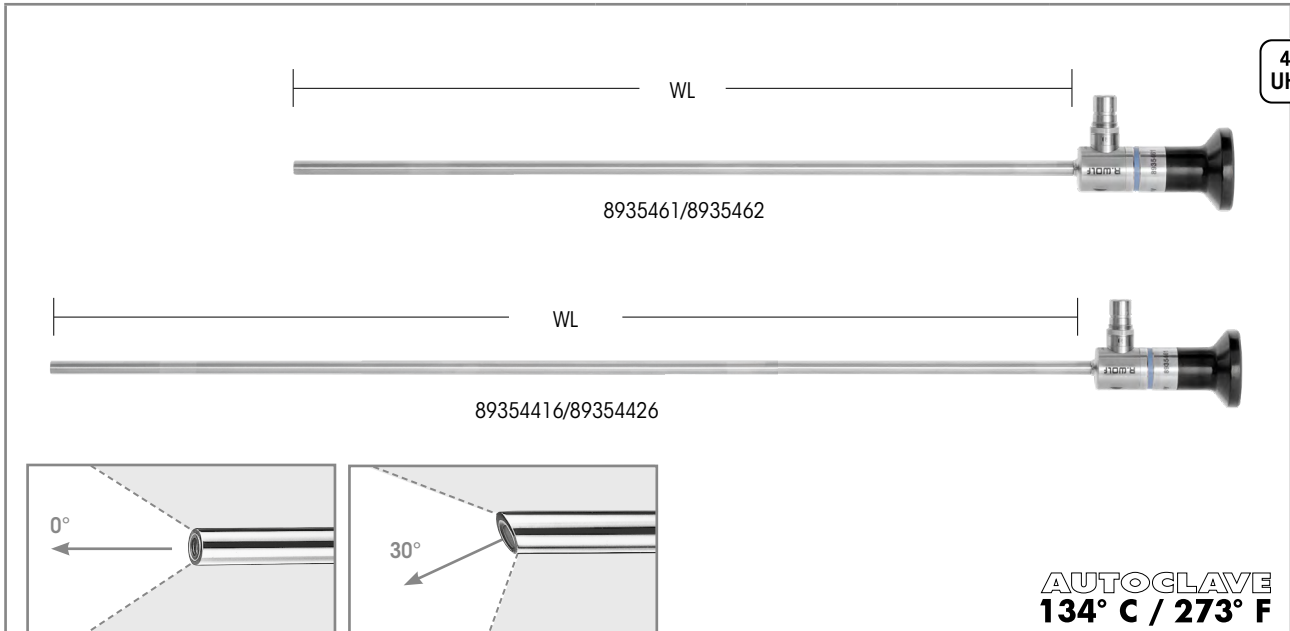

	Direction of view	WL	Ø	Product no.
PANOVIEW ULTRA Telescope Ø 5.5 mm WL 300 mm	0°	300 mm	5.5 mm	<b>8935461</b>
PANOVIEW ULTRA Telescope Ø 5.5 mm WL 300 mm	30°			<b>8935462</b>
PANOVIEW ULTRA Telescope Ø 5.5 mm WL 430 mm	0°	430 mm		<b>89354416</b>
PANOVIEW ULTRA Telescope Ø 5.5 mm WL 430 mm	30°			<b>89354426</b>

Recommended accessories		Product no.
<b>Perforated basket for standard telescope 2</b> (for telescope 8935416/8935426)	(W x H x D) 481 x 54 x 59 mm	<b>38016</b>
<b>Perforated basket for standard telescope 3</b> (for telescope 89354416/89354426)	(W x H x D) 619 x 54 x 59 mm	<b>38017</b>
<b>Fiber light cable bndI</b> consisting of: Fiber light cable (80663523), projector-side adapter (8095.07), and endoscope-side adapter (809509)	Ø 3.5 mm, 2.3 m long	<b>806635231</b>

11123 || Subject to modifications. Please note that some products may not be available in all countries. Please always take note of the information that is provided with the product. For more detailed information, please consult with your contact partner or directly with Richard Wolf GmbH.

# LAPAROSCOPES 10 MM

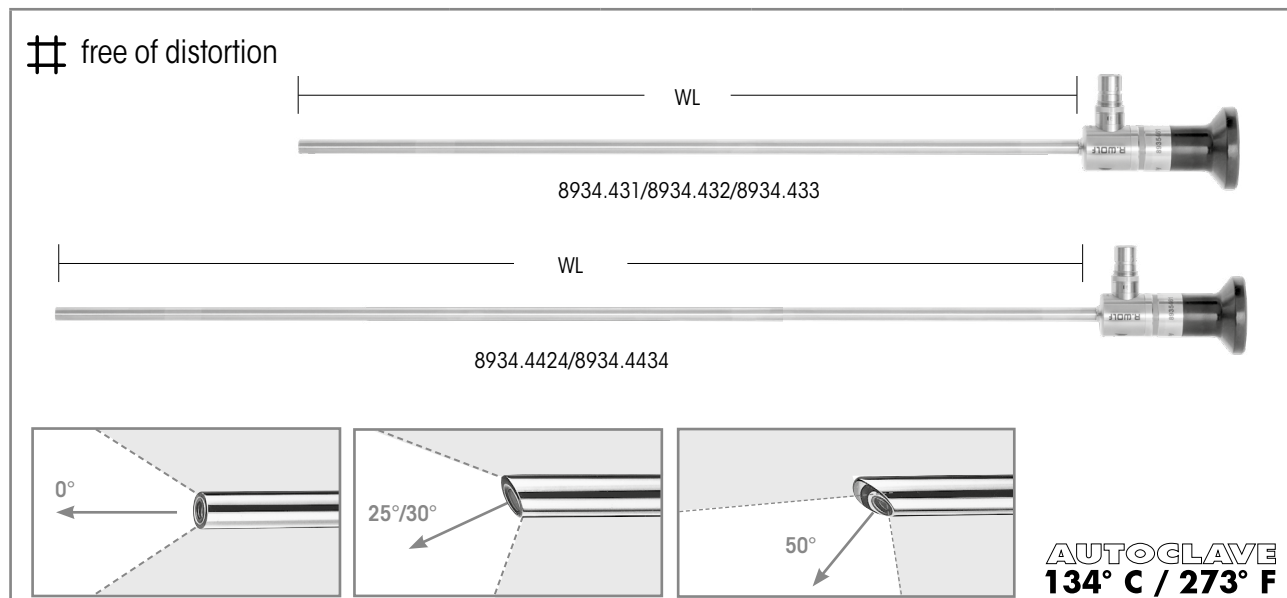

	Direction of view	WL	TL	Ø	Product no.
PANOVIEW Telescope 0° Ø 10 mm WL 307 mm	0°	307 mm	375 mm	10 mm	<b>8934.431</b>
PANOVIEW Telescope 30° Ø 10 mm WL 307 mm	30°	307 mm	375 mm		<b>8934.432</b>
PANOVIEW Telescope 50° Ø 10 mm WL 310 mm	50°	310 mm	378 mm		<b>8934.433</b>
PANOVIEW PLUS Telescope 25° Ø 10 mm WL 438 mm	25°	438 mm	507 mm		<b>8934.4424</b>
PANOVIEW PLUS Telescope 50° Ø 10 mm WL 447 mm	50°	447 mm	516 mm		<b>8934.4434</b>

Recommended accessories		Product no.
<b>Perforated basket for standard telescope 2</b> (for telescope 8934.431/.432/.433)	(W x H x D) 481 x 54 x 59 mm	<b>38016</b>
<b>Perforated basket for standard telescope 3</b> (for telescope 8934.4424/.4434)	(W x H x D) 619 x 54 x 59 mm	<b>38017</b>
<b>Fiber lightcable bndl</b> consisting of: Fiber light cable Ø 5 mm TL 2.3 m (80665023), projector-side adapter (8095.07), and endoscope-side adapter (809509)	Ø 5.0 mm, 2.3 m long	<b>806650231</b>
<b>Fusion Fiber light cable bndl</b> consisting of: Fiber light cable Ø 5 mm TL 2.3 m (80655023), projector-side adapter (8095.07), and endoscope-side adapter (809509)	Ø 5.0 mm, 2.3 m long	<b>806550231</b>

III23 || Subject to modifications. Please note that some products may not be available in all countries. Please always take note of the information that is provided with the product. For more detailed information, please consult with your contact partner or directly with Richard Wolf GmbH.

# 3D ENDOSCOPE 10 MM

# free of distortion

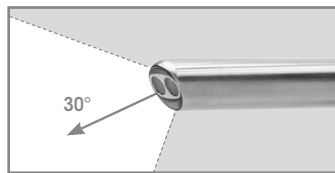
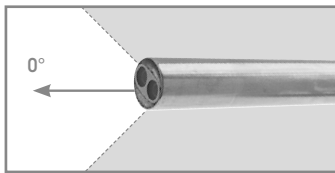
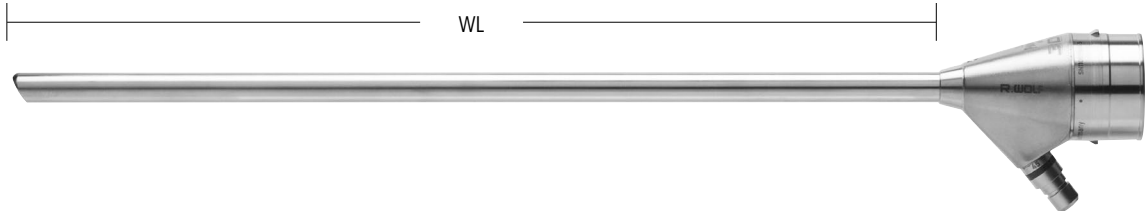

**AUTOCLAVE**  
**134° C / 273° F**

	Direction of view	WL	TL	Ø	Product no.
3D endoscope 0° Ø 10 mm WL 300 mm	0°	300 mm	366 mm	10 mm	8934631
3D endoscope 0° Ø 10 mm WL 435 mm		435 mm	500 mm		89344631
3D endoscope 30° Ø 10 mm WL 301 mm	30°	301 mm	366 mm		8934632
3D endoscope 30° Ø 10 mm WL 435 mm		435 mm	501 mm		89344632

Recommended accessories		Product no.
<b>Perforated basket for 3D telescope</b> 	(W x H x D): 583 x 200 x 80 mm	<b>38014</b>
Fusion <b>Fiber light cable bndl</b> consisting of: Fiber light cable Ø 5 mm TL 2.3 m (80655023), projector-side, adapter (8095.07), and endoscope-side adapter (809509)	Ø 5.0 mm, 2.3 m long	<b>806550231</b>

||123 || Subject to modifications. Please note that some products may not be available in all countries. Please always take note of the information that is provided with the product. For more detailed information, please consult with your contact partner or directly with Richard Wolf GmbH.

# SURGICAL LAPAROSCOPE 10 MM

## FOR ONE HOLE APPENDECTOMY

TELESOPES

2

# free of distortion

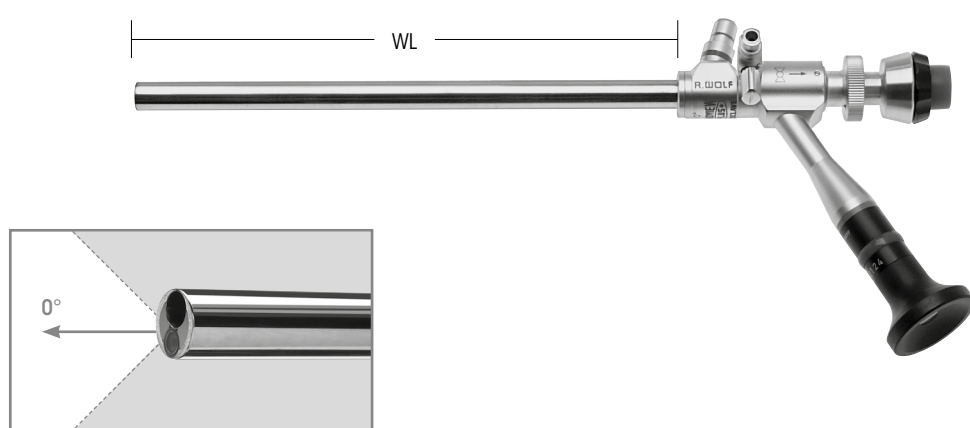

**AUTOCLAVE**  
**134° C / 273° F**

	Direction of view	WL	TL	Ø	Working channel Ø	Product no.
<b>PANOVIEW PLUS</b> <b>OR endoscope 0° Ø 10 mm WL 188 mm</b>  with lateral eyepiece	0°	188 mm	285 mm	10 mm	5.1 mm	<b>8915.501</b>

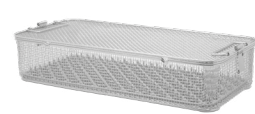
Recommended accessories		Product no.
<b>Universal perforated basket 4</b> (W x H x D): 538 x 117 x 250 mm		<b>33004</b>
for this: <b>Instrument mat for perforated basket</b>		<b>33001</b>
<b>Fiber light cable bndl</b> consisting of: Fiber light cable Ø 5 mm TL 2.3 m (80655023), projector-side adapter (8095.07), and endoscope-side adapter (809509)	Ø 5.0 mm, 2.3 m long	<b>806650231</b>
Fusion <b>Fiber light cable bndl</b> consisting of: Fiber light cable Ø 5 mm TL 2.3 m (80655023), projector-side adapter (8095.07), and endoscope-side adapter (809509)	Ø 5.0 mm, 2.3 m long	<b>806550231</b>

III23 || Subject to modifications. Please note that some products may not be available in all countries. Please always take note of the information that is provided with the product. For more detailed information, please consult with your contact partner or directly with Richard Wolf GmbH.





**AUTOCLAVE**  
**134° C / 273° F**



	Direction of view	WL	TL	Ø	Product no.
PANOVIEW ULTRA Telescope 0° Ø 10 mm WL 305 mm	0°	305 mm	375 mm	10 mm	8934461
PANOVIEW ULTRA Telescope 30° Ø 10 mm WL 305 mm	30°				8934462
PANOVIEW ULTRA Telescope 50° Ø 10 mm WL 305 mm	50°				8934463

**Note:** Compatible with System green (see Imaging Catalog) (ICG/NIR-capable) and its recommended Fusion fiber light cable

Recommended accessories		Product no.
<b>Perforated basket for standard telescope 2</b>	(W x H x D) 481 x 54 x 59 mm	<b>38016</b>
<b>Fiber lightcable bndl</b> consisting of: Fiber light cable Ø 5 mm TL 2.3 m (80665023), projector-side adapter (8095.07), and endoscope-side adapter (809509)	Ø 5.0 mm, 2.3 m long	<b>806650231</b>
<b>Fusion fiber lightcable bndl</b> consisting of: Fiber light cable Ø 5 mm TL 2.3 m (80655023), projector-side adapter (8095.07), and endoscope-side adapter (809509)	Ø 5.0 mm, 2.3 m long	<b>806550231</b>

**AUTOCLAVE**  
**134° C / 273° F**



	Direction of view	WL	TL	Ø	Product no.
PANOVIEW ULTRA Telescope 0° Ø 10 mm WL 440 mm	0°	440 mm	510 mm	10 mm	<b>89344416</b>
PANOVIEW ULTRA Telescope 30° Ø 10 mm WL 440 mm	30°				<b>89344426</b>
PANOVIEW ULTRA Telescope 50° Ø 10 mm WL 440 mm	50°				<b>89344436</b>

**Note:** Compatible with System green (see Imaging Catalog) (ICG/NIR-capable) and its recommended Fusion fiber light cable

Recommended accessories		Product no.
<b>Perforated basket for standard telescope 3</b>	(W x H x D) 619 x 54 x 59 mm	<b>38017</b>
<b>Fiber lightcable bndl</b> consisting of: Fiber light cable Ø 5 mm TL 2.3 m (80665023), projector-side adapter (8095.07), and endoscope-side adapter (809509)	Ø 5.0 mm, 2.3 m long	<b>806650231</b>
Fusion <b>Fiber light cable bndl</b> consisting of: Fiber light cable Ø 5 mm TL 2.3 m (80655023), projector-side adapter (8095.07), and endoscope-side adapter (809509)	Ø 5.0 mm, 2.3 m long	<b>806550231</b>

III23 || Subject to modifications. Please note that some products may not be available in all countries. Please always take note of the information that is provided with the product. For more detailed information, please consult with your contact partner or directly with Richard Wolf GmbH.

**LIGHT TUBE FOR MILOS METHOD  
(MINI LESS OPEN SUBLAY METHOD)**



**AUTOCLAVE  
134° C / 273° F**

		Ø	TL	Product no.
	<p><b>Light tube for MILOS method Ø 10 mm</b></p> <p>Instrument channel for 5 mm instruments</p>	10 mm	200 mm	<b>893420</b>

Recommended accessories	Product no.	
<p><b>Fiber light cable bndl</b> consisting of: Fiber light cable Ø 5 mm, TL 2.3 m (80665023), projector-side adapter (8095.07), and endoscope-side adapter (809509)</p>	Ø 5.0 mm, 2.3 m long	<b>806650231</b>
<p>Fusion <b>Fiber light cable bndl</b> consisting of: Fiber light cable Ø 5 mm, TL 2.3 m (80655023), projector-side adapter (8095.07), and endoscope-side adapter (809509)</p>	Ø 5.0 mm, 2.3 m long	<b>806550231</b>
Sealing cap, sulfur yellow, cap. 1.3 mm		<b>8934201</b>

11123 || Subject to modifications. Please note that some products may not be available in all countries. Please always take note of the information that is provided with the product. For more detailed information, please consult with your contact partner or directly with Richard Wolf GmbH.

LAPAROSCOPES  
ACCESSORIES

			Product no.
	<b>Sterile adapter</b>	immersible and autoclavable for changing telescopes	<b>8580.91</b>

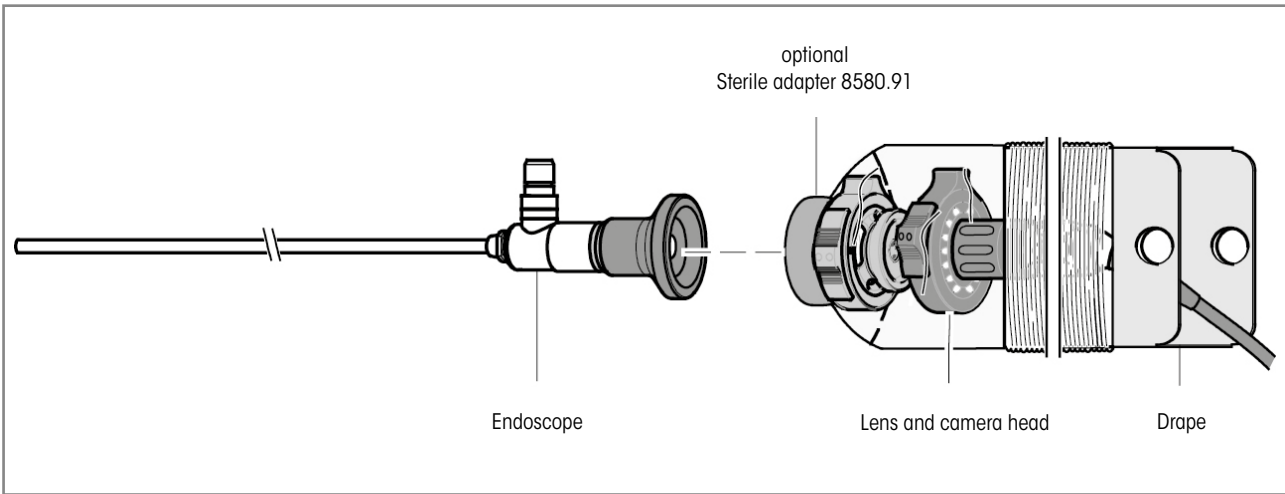



# TROCAR SLEEVES 2.2 / 2.5 MM

				Tip triangular
				Trocar tip triangular Size 2.2 mm
<b>Plastic sheath tube with thread</b>	<b>WL</b>	<b>Capacity</b>	<b>Product no.</b>	WL 82 mm
Trocar sleeve capacity 2.2 mm WL 60 mm with universal sealing valve	60 mm	2.2 mm	<b>8309.072</b>	<b>8309.121</b>







Trocar sleeve with insufflation connector  				Tip triangular
				Trocar tip triangular Size 2.2 mm
<b>Stainless steel sheath tube, smooth</b>	<b>WL</b>	<b>Capacity</b>	<b>Product no.</b>	WL 82 mm
Trocar sleeve capacity 2.5 mm WL 95 mm	95 mm	2.5 mm	<b>8309.014</b>	<b>8309.121</b>
				WL 119 mm
Trocar sleeve capacity 2.5 mm WL 95 mm	95 mm	2.5 mm	<b>8309.014</b>	<b>8309.123</b>

<b>Accessories</b>	<b>Product no.</b>
Rubber cap capacity 0.8 mm (PACK= 10 PCS) red	<b>88.01</b>

11123 || Subject to modifications. Please note that some products may not be available in all countries. Please always take note of the information that is provided with the product. For more detailed information, please consult with your contact partner or directly with Richard Wolf GmbH.

# TROCAR SLEEVES 3.5 MM

## WITH INSUFFLATION STOPCOCK







<b>RIWO-ART trocar sleeves</b> with magnetic ball valve with insufflation stopcock				<b>Tip tapered/blunt</b>	<b>Tip triangular</b>
					
				<b>Trocar tip blunt</b> Size 3.5 mm	<b>Trocar tip triangular</b> Size 3.5 mm
<b>Stainless steel sheath tube, smooth</b>	WL	Capacity	<b>Product no.</b>	WL 169 mm	WL 169 mm
<b>Trocar sleeve straight</b> capacity 3.5 mm WL 100 mm	 100 mm	3.5 mm	<b>8903.014</b>	<b>8903.103</b>	<b>8903.123</b>
<b>Plastic sheath tube with thread</b>					
<b>Trocar sleeve straight</b> capacity 3.5 mm WL 100 mm	 100 mm	3.5 mm	<b>8903.034</b>	<b>8903.103</b>	<b>8903.123</b>
				WL 129 mm	WL 129 mm
<b>Trocar sleeve slanted</b> capacity 3.5 mm WL 60 mm	 60 mm	3.5 mm	<b>8903.072</b>	<b>8903.101</b>	<b>8903.121</b>

Accessories	Product no.
Spare ball capacity 5.5 mm	8921.901
Spare O rings capacity 3.5 mm (PACK= 10 PCS), capacity Ø 3.5–5.5 mm	8921.951
Sealing cap capacity 2.4–3.4 mm (PACK= 10 PCS) red	89.01
Stopcock insert bndl cap. 3.0 mm (PACK= 5 PCS)	896.0002

<b>Trocar sleeve</b> with membrane valve				<b>Tip tapered/blunt</b>	
				<b>Trocar tip blunt</b> Size 3.5 mm	
<b>Plastic sheath tube with distal screw anchor</b>	WL	Capacity	<b>Product no.</b>	WL 169 mm	
<b>Trocar sleeve straight</b> capacity 3.5 mm WL 40 mm	 40 mm	3.5 mm	<b>8929.223</b>	<b>8903.103</b>	



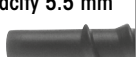



III23 || Subject to modifications. Please note that some products may not be available in all countries. Please always take note of the information that is provided with the product. For more detailed information, please consult with your contact partner or directly with Richard Wolf GmbH.

# TROCAR SLEEVES 5.5 MM

<b>RIWO-ART trocar sleeves</b> with magnetic ball valve with insufflation stopcock 				Tip tapered/blunt	Tip tapered/ pointed	Tip triangular
				Trocar tip blunt Size 5.5 mm	Trocar tip pointed Size 5.5 mm	Trocar tip triangular Size 5.5 mm
<b>Stainless steel sheath tube</b>	<b>WL</b>	<b>Capacity</b>	<b>Product no.</b>	<b>WL 169 mm</b>	<b>WL 169 mm</b>	<b>WL 169 mm</b>
<b>Trocar sleeve straight capacity 5.5 mm</b> <b>WL 100 mm</b> smooth 	100 mm	5.5 mm	<b>8921.014</b>	<b>8921.103</b>	<b>8921.113</b>	<b>8921.123</b>
<b>Trocar sleeve slanted capacity 5.5 mm</b> <b>WL 100 mm</b> smooth 	100 mm	5.5 mm	<b>8921.013</b>	<b>8921.103</b>	<b>8921.113</b>	<b>8921.123</b>
<b>Trocar sleeve straight capacity 5.5 mm</b> <b>WL 100 mm</b> with thread 	100 mm	5.5 mm	<b>8921.024</b>	<b>8921.103</b>	<b>8921.113</b>	<b>8921.123</b>
<b>Trocar sleeve slanted capacity 5.5 mm</b> <b>WL 100 mm</b> with thread 	100 mm	5.5 mm	<b>8921.023</b>	<b>8921.103</b>	<b>8921.113</b>	<b>8921.123</b>
Plastic tube <b>Trocar sleeve straight capacity 5.5 mm</b> <b>WL 100 mm</b> with thread 	100 mm	5.5 mm	<b>8921.034</b>	<b>8921.103</b>	<b>8921.113</b>	<b>8921.123</b>
				<b>WL 219 mm</b>	<b>WL 219 mm</b>	<b>WL 219 mm</b>
<b>Trocar sleeve straight capacity 5.5 mm</b> <b>WL 150 mm</b> smooth 	150 mm	5.5 mm	<b>8921.016</b>	<b>8921.105</b>	<b>8921.115</b>	<b>8921.125</b>
<b>Trocar sleeve straight capacity 5.5 mm</b> <b>WL 150 mm</b> with thread 	150 mm	5.5 mm	<b>8921.026</b>	<b>8921.105</b>	<b>8921.115</b>	<b>8921.125</b>

Accessories	Product no.
<b>Spare ball capacity 5.5 mm</b>	<b>8921.901</b>
<b>Spare O rings capacity 3.5 mm (PACK= 10 PCS), capacity Ø 3.5–5.5 mm</b>	<b>8921.951</b>
<b>Sealing cap capacity 3.4–5.1 mm (PACK= 10 PCS) blue</b>	<b>89.02</b>
<b>Stopcock insert bndl cap. 3.0 mm (PACK= 5 PCS)</b>	<b>896.0002</b>

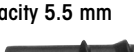
# TROCAR SLEEVES 5.5 MM





RIWO-ART trocar sleeves with magnetic ball valve 				Tip tapered/blunt	Tip tapered/ pointed	Tip triangular	
				Trocar tip blunt Size 5.5 mm	Trocar tip pointed Size 5.5 mm	Trocar tip triangular Size 5.5 mm	
Stainless steel sheath tube		WL	Capacity	Product no.	WL 129 mm	WL 129 mm	WL 129 mm
Trocar sleeve straight capacity 5.5 mm WL 60 mm smooth 		60 mm	5.5 mm	8921.052	8921.101	8921.111	8921.121
Trocar sleeve slanted capacity 5.5 mm WL 60 mm smooth 		60 mm	5.5 mm	8921.051	8921.101	8921.111	8921.121
Trocar sleeve straight capacity 5.5 mm WL 60 mm with thread 		60 mm	5.5 mm	8921.062	8921.101	8921.111	8921.121
Trocar sleeve slanted capacity 5.5 mm WL 60 mm with thread 		60 mm	5.5 mm	8921.061	8921.101	8921.111	8921.121
Plastic tube Trocar sleeve straight capacity 5.5 mm WL 60 mm with thread 		60 mm	5.5 mm	8921.072	8921.101	8921.111	8921.121
					WL 169 mm	WL 169 mm	WL 169 mm
Trocar sleeve straight capacity 5.5 mm WL 100 mm smooth 		100 mm	5.5 mm	8921.054	8921.103	8921.113	8921.123
Trocar sleeve straight capacity 5.5 mm WL 100 mm with thread 		100 mm	5.5 mm	8921.053	8921.103	8921.113	8921.123

Accessories	Product no.
Spare ball capacity 5.5 mm	8921.901
Spare O rings capacity 3.5 mm (PACK= 10 PCS), capacity Ø 3.5–5.5 mm	8921.951
Sealing cap capacity 3.4–5.1 mm (PACK= 10 PCS) blue	89.02

# TROTEC

## TROCAR WITH AUTOMATIC PROTECTIVE FUNCTION

### FOR TROCAR SLEEVES 5.5 MM

Trocar consisting of:		Product no.	for RIWO-ART trocar sleeve with WL 100 mm, Ø 5,5 mm
Sheath with trocar tip Size 5.5 mm WL 181 mm	<b>Tapered tip</b> 	8921.132	
Sheath with trocar tip Size 5.5 mm WL 181 mm	<b>Two-sided tip</b> 	8921.134	
<b>Spring-loaded protective rod</b> WL 184 mm		8923.135	

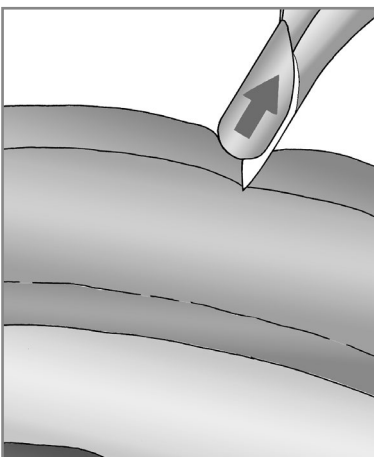

Protective tip automatically pushes back into the cannula through contact with the abdominal wall

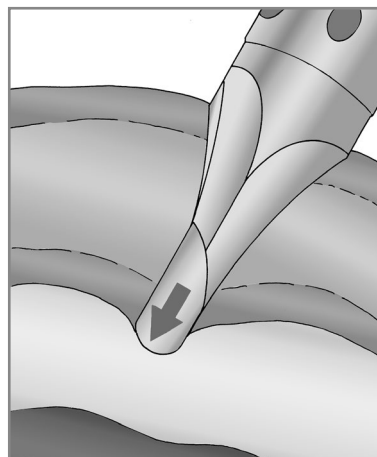

The protective tip advances into the free abdomen immediately after penetration of the peritoneum

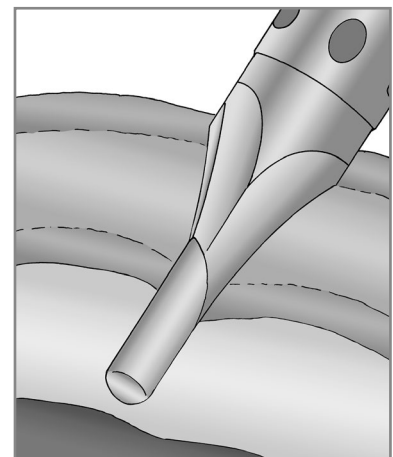









The atraumatic protective tip in a far distal position prevents perforation of organs and vessels

11123 | Subject to modifications. Please note that some products may not be available in all countries. Please always take note of the information that is provided with the product. For more detailed information, please consult with your contact partner or directly with Richard Wolf GmbH.

# TROCAR SLEEVE 5.5 MM/5.8 MM

PLASTIC WITH SEALING MEMBRANE

 <p><b>AUTOCLAVE</b> <b>134° C / 273° F</b></p>					Tip tapered/blunt	Tip tapered/pointed	Tip triangular
							
					Trocar tip blunt Size 5.5 mm	Trocar tip pointed Size 5.5 mm	Trocar tip triangular Size 5.5 mm
Flexible plastic sheath tube with thread	WL	Capacity	with stopcock	Product no.	WL 104 mm	WL 104 mm	WL 104 mm
Trocar sleeve straight capacity 5.5 mm WL 62 mm with membrane valve	62 mm	5.5 mm	●	8919.333	8919.3311	8919.3312	8919.3313
				8919.331			
					WL 144 mm	WL 144 mm	WL 144 mm
Trocar sleeve straight capacity 5.5 mm WL 102 mm with membrane valve	102 mm	5.5 mm	●	8919.353	8919.3511	8919.3512	8919.3513
				8919.351			

for curved instruments				Tip tapered/blunt	Tip tapered/pointed	Tip triangular	Tip tapered/blunt
 <p><b>AUTOCLAVE</b> <b>134° C / 273° F</b></p>							
				Trocar tip blunt Size 5.5 mm	Trocar tip pointed Size 5.5 mm	Trocar tip triangular Size 5.5 mm	Trocar tip blunt Size 5.5 mm
Flexible plastic sheath tube with thread	WL	Capacity	Product no.	WL 80 mm	WL 80 mm	WL 80 mm	WL 80 mm
Trocar sleeve straight capacity 5.8 mm WL 62 mm with membrane valve	62 mm	5.8 mm	8905.331	8905.3311	8905.3312	8905.3313	8905.3315
				WL 120 mm	WL 120 mm	WL 120 mm	WL 120 mm
Trocar sleeve straight capacity 5.8 mm WL 102 mm with membrane valve	102 mm	5.8 mm	8905.3515	8905.3511	8905.3512	8905.3513	8905.3515

Accessories	Product no.
Sealing membrane Ø 17 mm, yellow (PACK= 10 PCS)	89.103
Stopcock insert bndl cap 3.0 mm (PACK= 5 PCS)	896.0002







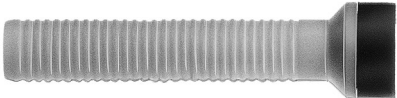

# TROCAR SLEEVE 5.7 MM/7 MM/10 MM/12.5 MM

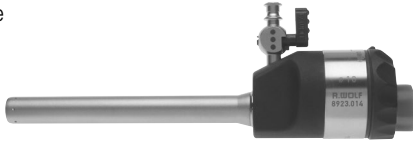
## FLEXIBLE PLASTIC SHEATH TUBE

				Tip tapered/blunt
				Trocar tip blunt
Flexible plastic sheath tube with thread	WL	Capacity	Product no.	Size 5.5 mm/WL 83 mm
Trocar sleeve straight capacity 5.7 mm WL 60 mm with rubber cap	60 mm	5.7 mm	8906.051	8906.151

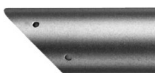
				Tip tapered/blunt
				Trocar tip blunt
Ribbed flexible plastic sheath tube	WL	Capacity	Product no.	Size 7.3 mm/TL 108 mm
Trocar sleeve flexible capacity 7 mm WL 74 mm with universal seal	74 mm	7 mm	8906.001	8913.11
				Size 10 mm/TL 85 mm
Trocar sleeve flexible capacity 10 mm WL 56 mm with universal seal	56 mm	10 mm	8906.011	8906.111
				Size 12.5 mm/TL 86 mm
Trocar sleeve flexible capacity 12.5 mm WL 57 mm with universal seal	57 mm	12.5 mm	8906.031	8906.131

# TROCAR SLEEVE 10 MM WITH INSUFFLATION STOPCOCK





RIWO-ART trocar sleeves with magnetic ball valve 				Tip tapered/blunt 	Tip tapered/pointed 	Tip triangular 	
				Trocar tip blunt Size 10 mm	Trocar tip pointed Size 10 mm	Trocar tip triangular Size 10 mm	
Stainless steel sheath tube		WL	Capacity	Product no.	WL 164 mm	WL 164 mm	WL 164 mm
Trocar sleeve straight capacity 10 mm WL 100 mm 	100 mm	10 mm	<b>8923.014</b>	<b>8923.103</b>	<b>8923.113</b>	<b>8923.123</b>	
Trocar sleeve slanted capacity 10 mm WL 100 mm 	100 mm	10 mm	<b>8923.013</b>	<b>8923.103</b>	<b>8923.113</b>	<b>8923.123</b>	
Trocar sleeve straight capacity 10 mm WL 100 mm with thread 	100 mm	10 mm	<b>8923.024</b>	<b>8923.103</b>	<b>8923.113</b>	<b>8923.123</b>	
Trocar sleeve slanted capacity 10 mm WL 100 mm with thread 	100 mm	10 mm	<b>8923.023</b>	<b>8923.103</b>	<b>8923.113</b>	<b>8923.123</b>	
				WL 214 mm	WL 214 mm	WL 214 mm	
Trocar sleeve straight capacity 10 mm WL 150 mm 	150 mm	10 mm	<b>8923.016</b>	-	<b>8923.115</b>	<b>8923.125</b>	
Trocar sleeve straight capacity 10 mm WL 150 mm with thread 	150 mm	10 mm	<b>8923.026</b>	-	<b>8923.115</b>	<b>8923.125</b>	

Accessories	Product no.
Spare ball capacity 7 mm	<b>8923901</b>
Spare O rings capacity 7 mm (PACK= 10 PCS), capacity Ø 7–12.5 mm	<b>8923951</b>
Sealing cap capacity 9.5–10.1 mm (PACK= 10 PCS) red	<b>8908</b>
Stopcock insert bndl cap. 3.0 mm (PACK= 5 PCS)	<b>896.0002</b>

III23 || Subject to modifications. Please note that some products may not be available in all countries. Please always take note of the information that is provided with the product. For more detailed information, please consult with your contact partner or directly with Richard Wolf GmbH.



**TROTEC**  
**TROCAR WITH AUTOMATIC PROTECTIVE FUNCTION**  
 FOR TROCAR SLEEVES 10 MM

Trocar consisting of:		Product no.	for RIWO-ART trocar sleeve with WL 100 mm, ø 10 mm
Sheath with trocar tip Size 10 mm WL 181 mm	Tapered tip 	8923.132	
Sheath with trocar tip Size 10 mm WL 181 mm	Two-sided tip 	8923.134	
Spring-loaded protective rod WL 184 mm		8923.135	

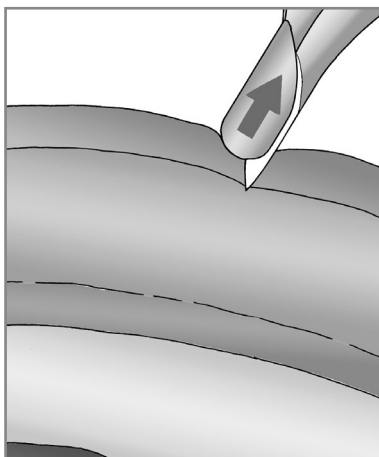

Protective tip automatically pushes back into the cannula through contact with the abdominal wall

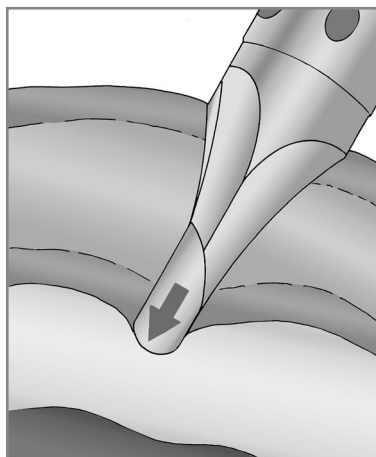

The protective tip advances into the free abdomen immediately after penetration of the peritoneum

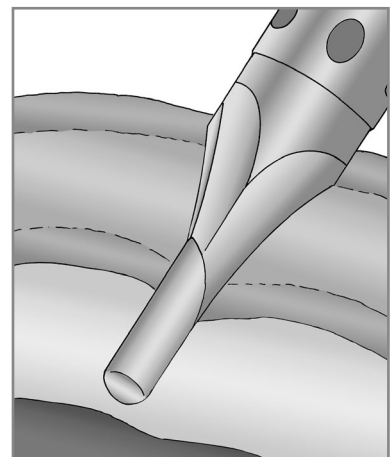

The atraumatic protective tip in a far distal position prevents perforation of organs and vessels





11123 | Subject to modifications. Please note that some products may not be available in all countries. Please always take note of the information that is provided with the product. For more detailed information, please consult with your contact partner or directly with Richard Wolf GmbH.

# HIGH FLOW TROCAR SLEEVE 10 MM

## WITH CONNECTOR FOR HIGH FLOW INSUFFLATION TUBE

TROCAR SLEEVES

3







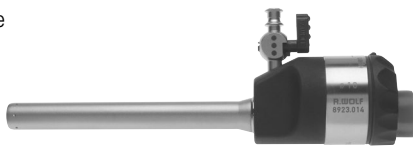

RIWO-ART trocar sleeves with magnetic ball valve 				Tip tapered/blunt	Tip tapered/pointed	Tip triangular		
								
				Trocar tip blunt Size 10 mm	Trocar tip pointed Size 10 mm	Trocar tip triangular Size 10 mm		
Stainless steel sheath tube		WL	Capacity	Product no.	WL 164 mm	WL 164 mm	WL 164 mm	
Trocar sleeve straight capacity 10 mm WL 100 mm			100 mm	10 mm	<b>8923.042</b>	<b>8923.103</b>	<b>8923.113</b>	<b>8923.123</b>
for this:						Product no.		
Reducing adapter (PACK= 5 PCS)				for reduction from Ø 7 mm, Ø 10 mm, and Ø 12.5 mm to Ø 5.5 mm		<b>8923802</b>		

Accessories	Product no.
Spare ball capacity 7 mm	<b>8923901</b>
Spare O rings capacity 7 mm (PACK= 10 PCS), capacity Ø 7–12.5 mm	<b>8923951</b>
Sealing cap capacity 9.5–10.1 mm (PACK= 10 PCS) red	<b>8908</b>

11123 || Subject to modifications. Please note that some products may not be available in all countries. Please always take note of the information that is provided with the product. For more detailed information, please consult with your contact partner or directly with Richard Wolf GmbH.

# TROCAR SLEEVE 12.5 MM

## WITH INSUFFLATION STOPCOCK

RIWO-ART trocar sleeves with magnetic ball valve 				Tip tapered/blunt 	Tip tapered/pointed 	Tip triangular 	
				Trocar tip blunt Size 12.7 mm	Trocar tip pointed Size 12.7 mm	Trocar tip triangular Size 12.7 mm	
Stainless steel sheath tube		WL	Capacity	Product no.	WL 164 mm	WL 164 mm	WL 164 mm
Trocar sleeve straight capacity 12.5 mm WL 100 mm 	100 mm	12.5 mm	<b>8924.014</b>	<b>8924.103</b>	<b>8924.113</b>	<b>8924.123</b>	
Trocar sleeve slanted capacity 12.5 mm WL 100 mm 	100 mm	12.5 mm	<b>8924.013</b>	<b>8924.103</b>	<b>8924.113</b>	<b>8924.123</b>	
				WL 214 mm	WL 214 mm	WL 214 mm	
Trocar sleeve straight capacity 12.5 mm WL 150 mm with thread 	150 mm	12.5 mm	<b>8924.026</b>	-	<b>8924.115</b>	<b>8924.125</b>	
Trocar sleeve straight capacity 12.5 mm WL 150 mm 	150 mm	12.5 mm	<b>8924.016</b>	-	<b>8924.115</b>	<b>8924.125</b>	
for this:							
Reducing adapter (PACK= 5 PCS) 		for reduction from Ø 10 mm to Ø 5.5 mm and Ø 12.5 mm to Ø 5.5 mm			<b>8923.802</b>		
		for reduction from Ø 12.5 mm to Ø 10 mm			<b>8924.802</b>		

Accessories	Product no.
Spare ball capacity 7 mm	<b>8923.901</b>
Spare O rings capacity 7 mm (PACK= 10 PCS), capacity Ø 7–12.5 mm	<b>8923.951</b>
Sealing cap capacity 9.5–10.1 mm (PACK= 10 PCS) red	<b>89.08</b>
Stopcock insert bndl cap. 3.0 mm (PACK= 5 PCS)	<b>896.0002</b>





# TROTEC

## TROCAR WITH AUTOMATIC PROTECTIVE FUNCTION

### FOR TROCAR SLEEVES 12.5 MM

TROCAR SLEEVES

3

			
Trocar consisting of:		Product no.	for RIWO-ART trocar sleeve with WL 100 mm, Ø 12,5 mm
Sheath with trocar tip Size 12.5 mm WL 181 mm	Two-sided tip 	8924.134	
Spring-loaded protective rod WL 184 mm		8923.135	

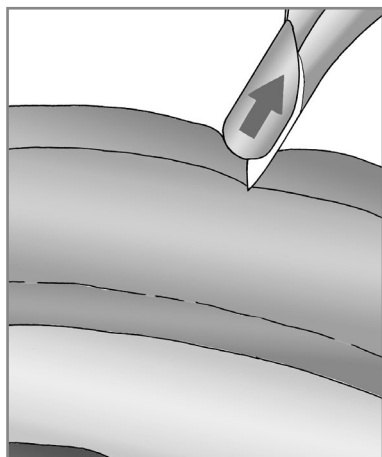

Protective tip automatically pushes back into the cannula through contact with the abdominal wall

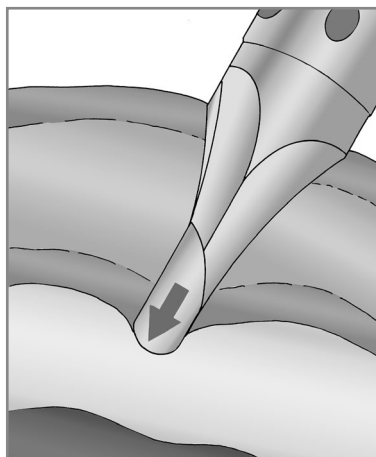

The protective tip advances into the free abdomen immediately after penetration of the peritoneum

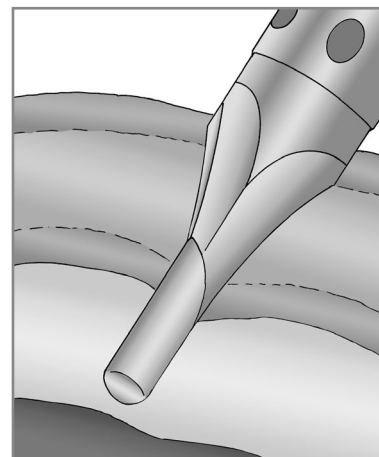

The atraumatic protective tip in a far distal position prevents perforation of organs and vessels

III23 || Subject to modifications. Please note that some products may not be available in all countries. Please always take note of the information that is provided with the product. For more detailed information, please consult with your contact partner or directly with Richard Wolf GmbH.

# DILATATION AND EXTRACTION INSTRUMENTS

## 5.5 TO 10/10 TO 12.5 MM

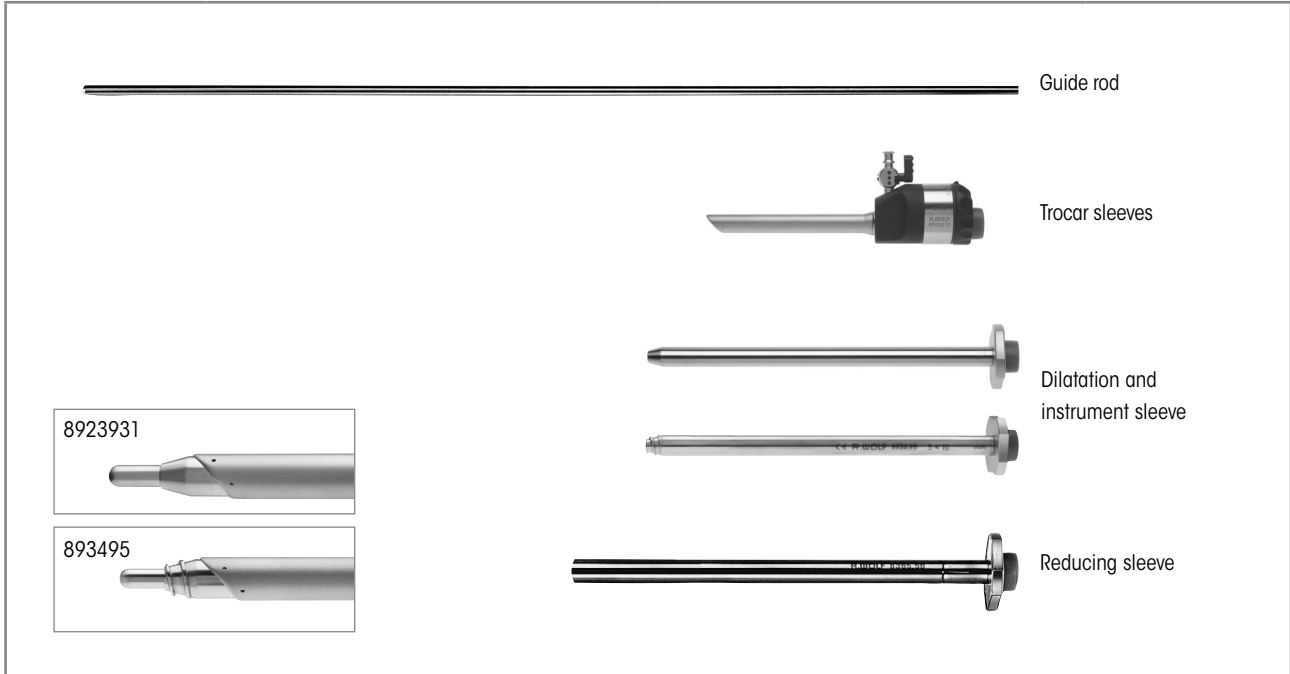

Incision widening	Guide rod	Trocar sleeve slanted	Dilatation sleeve	Instrument sleeve	Reducing sleeve
3.5 mm < 5.5 mm	-	<b>8921.013</b> capacity 5.5 mm WL 100 mm			<b>8383.78</b> Size 5 mm L 155 mm
5.5 mm < 10 mm	<b>8923.921</b> 5.5 mm TL 500 mm	<b>8923.013</b> capacity 10 mm WL 100 mm	<b>8923.931</b> Size 10 mm WL 170 mm	<b>8385.50</b> 10 mm WL 170 mm	
5.0 mm < 10 mm	<b>8934.951</b> 5 mm TL 500 mm		<b>8934.95</b> Size 10 mm WL 172 mm		
10 mm < 12.5 mm		<b>8924.013</b> capacity 12.5 mm WL 100 mm			<b>8941.901</b> 12 mm WL 180 mm
5.5 mm < 12.5 mm					<b>8941.951</b> 12 mm WL 180 mm
10 mm < 15 mm	<b>8943.901</b> 10 mm TL 500 mm				

11123 || Subject to modifications. Please note that some products may not be available in all countries. Please always take note of the information that is provided with the product. For more detailed information, please consult with your contact partner or directly with Richard Wolf GmbH.

## REDUCING SLEEVES FOR RIWO-ART TROCAR SLEEVES

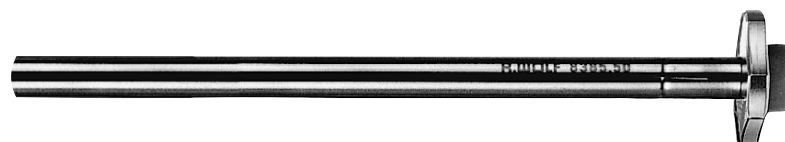



Stainless steel sheath tube	Outer Ø	WL	for instruments	Product no.
<b>Reducing sleeve</b> Size 5 mm WL 155 mm	5 mm	155 mm	3.5 mm	<b>8383.78</b>
<b>Instrument sleeve</b> 10 mm WL 170 mm	10 mm	170 mm	5.5 mm	<b>8385.50</b>
<b>Reducing sleeve</b> 12 mm WL 180 mm	12 mm	180 mm	10 mm	<b>8941.901</b>
<b>Reducing sleeve</b> 12 mm WL 180 mm	12 mm	180 mm	5.5 mm	<b>8941.951</b>
for this:				
<b>Reducing adapter</b> (PACK= 5 PCS)		for reduction from Ø 7 mm, Ø 10 mm, and Ø 12.5 mm to Ø 5.5 mm		<b>8923802</b>
		for reduction from Ø 12.5 mm to Ø 10 mm		<b>8924802</b>

Accessories	Product no.
<b>Sealing cap capacity 3.4–5.1 mm (PACK= 10 PCS) blue</b>	<b>89.02</b>
<b>Sealing cap capacity 9.5–10.1 mm (PACK= 10 PCS) red</b>	<b>8908</b>

# VERES CANNULAS

## FOR CREATION OF THE PNEUMOPERITONEUM

				
		Outer Ø	WL	Product no.
	VERES cannula Ø 2.1 mm WL 150 mm	<b>2.1 mm</b>	150 mm	<b>8302.15</b>
	VERES cannula Ø 2.1 mm WL 152 mm (standard length)		120 mm	<b>8302.12</b>
	VERES cannula Ø 2.1 mm WL 80 mm		80 mm	<b>8302.08</b>
<b>for this:</b>				
Tube with Luer-Lock connector				<b>886.00</b>

Accessories	Product no.
Stopcock insert bndl cap. 3.0 mm (PACK= 5 PCS)	<b>896.0002</b>

11123 || Subject to modifications. Please note that some products may not be available in all countries. Please always take note of the information that is provided with the product. For more detailed information, please consult with your contact partner or directly with Richard Wolf GmbH.

# ERAGON<sup>modular</sup>

## THE LAPAROSCOPIC TOOLBOX

### The toolbox principle

**ERAGONmodular** allows the surgeon to create their ideal laparoscopic set. Ergonomic handles, diameters relevant to all medical practice, useful working lengths, and a range of jaw sections can be combined as necessary. This universal compatibility also ensures that individual trays can comprise fewer instruments – for more efficiency and one way of cutting costs

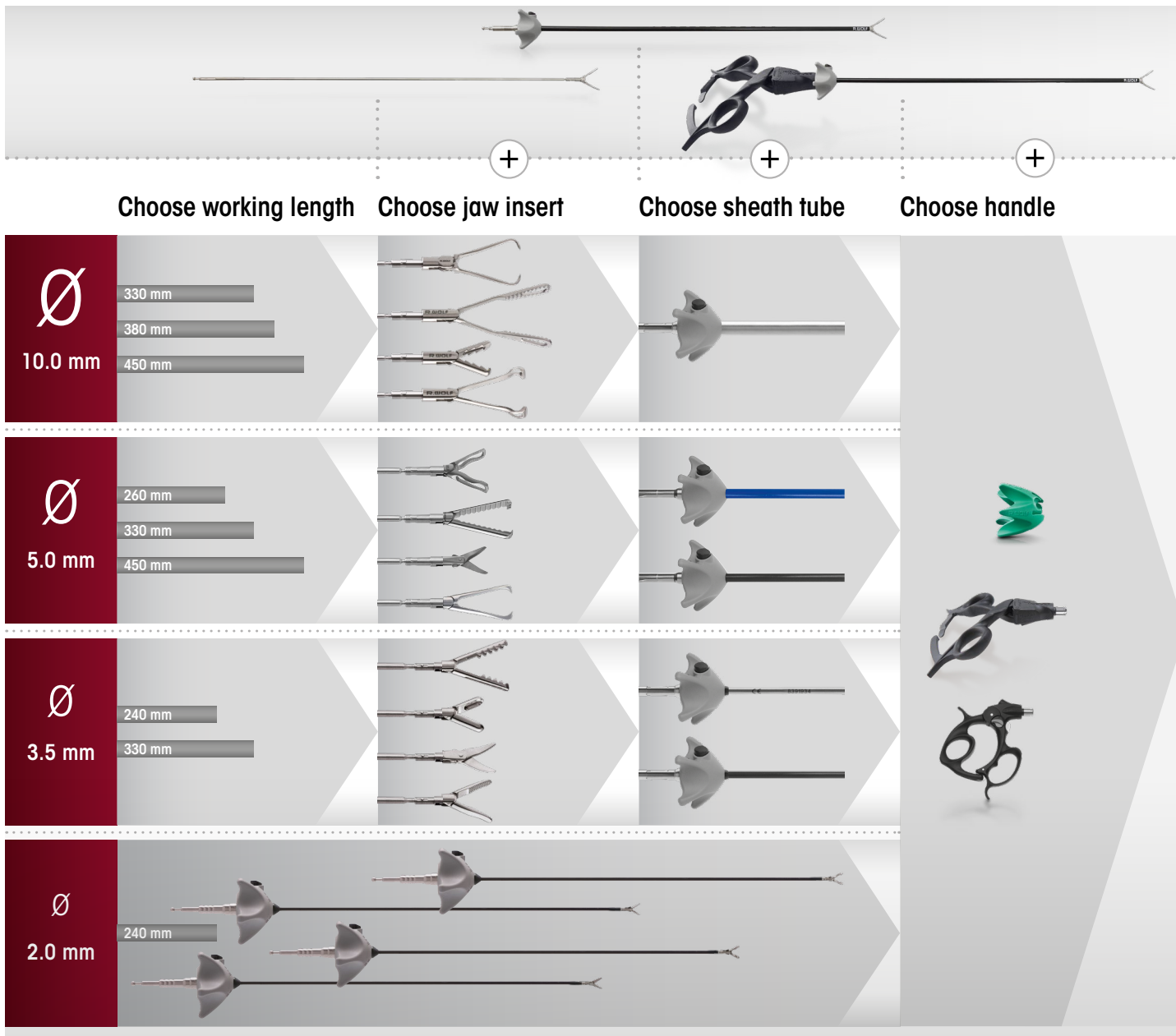



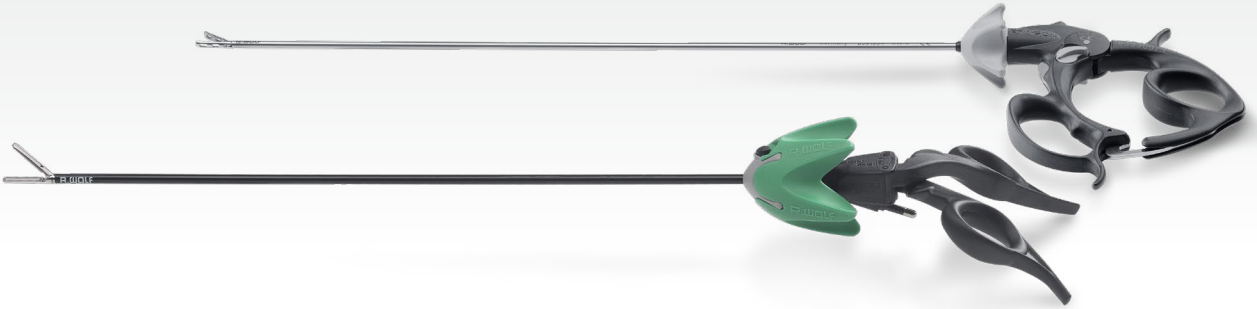



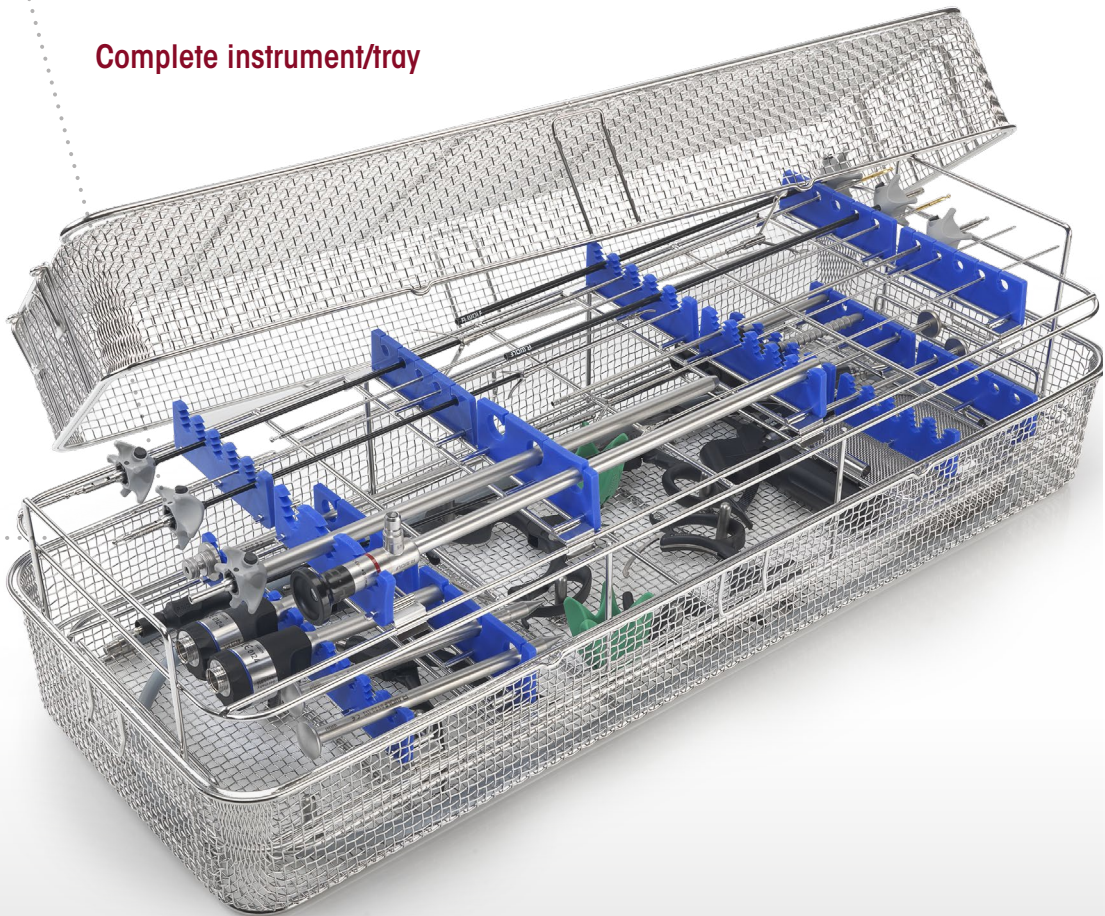





**Complete instrument/tray**







**ERAGON** modular  
micro  
Ø 2 MM, INSULATED

		Handle, axial	
<b>ERAGON</b> axial			
All jaw inserts and sheath tubes can also be combined with <b>ERAGON</b> axial		without lock, with HF connector	without lock, with HF connector
<b>Rotatable knob</b>	<b>Product no.</b>	83930083	83930084
	8988	•	•

Jaw insert			Sheath tube, Ø 2.0 mm, insulated	Handle, pistol-shaped	Complete instrument • Jaw insert with sheath tube • Handle
					<b>Product no.</b> 83930073
			WL 240 mm	without lock, with HF, mono	
	<b>JL*</b>	<b>Product no.</b>			<b>Product no.</b>
 Scissors mono Ø 2 mm bndl straight, double-action	7 mm	8388200	•	•	<b>83882007</b>
 Dissector forceps mono Ø 2 mm bndl straight, double-action	7 mm	8388201	•	•	<b>83882017</b>
 Atraumatic grasping forceps mono Ø 2 mm bndl fenestrated, double-action	7 mm	8388202	•	•	<b>83882027</b>

\* JL = jaw length when jaw section closed (approximate measurements)  
HF connection cable: see sheet BDE116/117

**ERAGON** *modular*  
*micro*  
Ø 2 MM, INSULATED

Jaw insert		Sheath tube, Ø 2.0 mm, insulated		Handle, pistol-shaped	Complete instrument • Jaw insert with sheath tube • Handle
					
		WL 240 mm		with lock, with HF, mono	
	JL*	Product no.		83930074	Product no.
 Grasping forceps mono Ø 2 mm bndl  double-action	7 mm	8388203	•	•	<b>83882037</b>

\* JL = jaw length when jaw section closed (approximate measurements)  
HF connection cable: see sheet BDE116/117



Accessories for manual and machine reprocessing		Product no.
	Irrigation adapter Ø 9 mm, length 64 mm	<b>163502</b>







**ERAGON** modular mini

Ø 3.5 MM, INSULATED

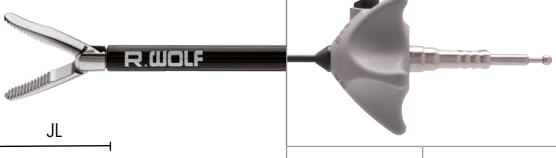
ERAGONMODULAR

4

		Handle, axial	
<b>ERAGON</b> axial			
All jaw inserts and sheath tubes can also be combined with <b>ERAGON</b> axial		without lock, with HF connector	without lock, with HF connector
<b>Rotatable knob</b>	<b>Product no.</b>	83930083	83930084
	8988	•	•

Jaw insert		Sheath tube, Ø 3.5 mm, insulated		Handle, pistol-shaped	Complete instrument	
					<ul style="list-style-type: none"> <li>• Jaw insert with sheath tube</li> <li>• Handle</li> </ul>	
JL		WL 240 mm	WL 330 mm	with lock, with HF, mono		
	JL*	<b>Product no.</b>	8390933	8391933	83930074	<b>Product no.</b>
	15 mm	8390207	•	•	•	<b>83902077</b>
curved to the left, double-action		8391207		•	•	<b>83912077</b>
	18 mm	8390221	•	•	•	<b>83902217</b>
long, fine tip, double-action		8391221		•	•	<b>83912217</b>
	14 mm	8390222	•	•	•	<b>83902227</b>
short, fine tip, double-action		8391222		•	•	<b>83912227</b>
	14 mm	8390223	•	•	•	<b>83902237</b>
angled, double-action		8391223		•	•	<b>83912237</b>









\* JL = jaw length when jaw section closed (approximate measurements)

HF connection cable: see sheet BDE116/117

|||23 || Subject to modifications. Please note that some products may not be available in all countries. Please always take note of the information that is provided with the product. For more detailed information, please consult with your contact partner or directly with Richard Wolf GmbH.

**ERAGON modular mini**

**Ø 3.5 MM, INSULATED**

Jaw insert			Sheath tube, Ø 3.5 mm, insulated		Handle, pistol-shaped		Complete instrument • Jaw insert with sheath tube • Handle
							
			WL 240 mm	WL 330 mm	without lock, with HF, mono	with lock, with HF, mono	
	JL*	Product no.	8390933	8391933	83930073	83930074	Product no.
 Metzenbaum scissors mono Ø 3.5 mm bndl 16 mm double-action		8390215	•		•		83902157
		8391215		•	•		83912157
 Metzenbaum scissors mono Ø 3.5 mm bndl 14 mm fine-toothed, curved, double-action		8390224	•		•		83902247
		8391224		•	•		83912247
 Hook scissors mono Ø 3.5 mm bndl 8 mm single-action		8390227	•		•		83902277
		8391227		•	•		83912277
 Double spoon forceps mono Ø 3.5 mm bndl 12 mm		8390216	•			•	83902167
		8391216		•		•	83912167
 Friedel punch mono Ø 3.5 mm bndl 10 mm		8390217	•			•	83902177
		8391217		•		•	83912177



\* JL = jaw length when jaw section closed (approximate measurements)







HF connection cable: see sheet BDE116/117

Accessories for manual and machine reprocessing		Product no.
	Irrigation adapter Ø 9 mm, length 64 mm	163502

1123 || Subject to modifications. Please note that some products may not be available in all countries. Please always take note of the information that is provided with the product. For more detailed information, please consult with your contact partner or directly with Richard Wolf GmbH.

**ERAGON** modular mini  
Ø 3.5 MM, UNINSULATED

		Handle, axial	
<b>ERAGON</b> axial			
All jaw inserts and sheath tubes can also be combined with <b>ERAGON</b> axial		with lock, without HF connector	with lock, without HF connector, not rotatable
<b>Rotatable knob</b>	<b>Product no.</b>	83930082	83930085
	8988	.	

Jaw insert		Sheath tube, Ø 3.5 mm, uninsulated		Handle, pistol-shaped	Complete instrument	
					<ul style="list-style-type: none"> <li>• Jaw insert with sheath tube</li> <li>• Handle</li> </ul>	
JL		WL 240 mm	WL 330 mm	with lock, without HF		
	JL*	<b>Product no.</b>	8390933	8391933	83930072	<b>Product no.</b>
	14 mm	8390208	.	.	.	<b>83902087</b>
fenestrated, double-action		8391208	.	.	.	<b>83912087</b>
	17 mm	8390218	.	.	.	<b>83902187</b>
fenestrated, single-action		8391218	.	.	.	<b>83912187</b>
	17 mm	8390225	.	.	.	<b>83902257</b>
double fenestrated, curved, single-action		8391225	.	.	.	<b>83912257</b>
	19 mm	8390226	.	.	.	<b>83902267</b>
fenestrated, double-action		8391226	.	.	.	<b>83912267</b>







\* JL = jaw length when jaw section closed (approximate measurements)

HF connection cable: see sheet BDE116/117

|||23 || Subject to modifications. Please note that some products may not be available in all countries. Please always take note of the information that is provided with the product. For more detailed information, please consult with your contact partner or directly with Richard Wolf GmbH.



**ERAGON modular mini**  
Ø 3.5 MM, UNINSULATED

Jaw insert			Sheath tube, Ø 3.5 mm, uninsulated		Handle, pistol-shaped	Complete instrument • Jaw insert with sheath tube • Handle
			WL 240 mm	WL 330 mm	 with lock, without HF	
			Product no.	8390933		8391933
 fenestrated, double-action	13 mm	8390219	•		•	83902197
		8391219		•	•	83912197
 fenestrated, single-action	17 mm	8390220	•		•	83902207
		8391220		•	•	83912207
 double-action	14 mm	8390209	•		•	83902097
		8391209		•	•	83912097
 double-action	19 mm	8390210	•		•	83902107
		8391210		•	•	83912107

\* JL = jaw length when jaw section closed (approximate measurements)







HF connection cable: see sheet BDE116/117







Accessories for manual and machine reprocessing		Product no.
	Irrigation adapter Ø 9 mm, length 64 mm	163503

**ERAGON** modular  
Ø 5.0 MM, INSULATED

ERAGONMODULAR

4

		Handle, axial			
 All jaw inserts and sheath tubes can also be combined with <b>ERAGONaxial</b>					
		with lock	without lock, with HF connector	without lock, with HF connector	with lock, not rotatable
<b>Rotatable knob</b>	<b>Product no.</b>	83930082	83930083	83930084	83930085
	8988	•	•	•	

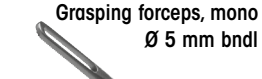
Jaw insert		Sheath tube, Ø 5.0 mm, insulated		Handle, pistol-shaped	Complete instrument
					<ul style="list-style-type: none"> <li>• Jaw insert with sheath tube</li> <li>• Handle</li> </ul>
	JL*	SL 330 mm	SL 450 mm	with lock, with HF, mono	<b>Product no.</b>
	<b>Product no.</b>	8393933	8394933	83930074	
	21 mm	•		•	<b>83932817</b>
Maryland dissector forceps mono Ø 5 mm bndl curved, with fine cross tothing, double-action		8393.281			
		8394.281	•	•	<b>83942817</b>
	22 mm	•		•	<b>83932837</b>
Mixer dissector forceps mono Ø 5 mm bndl angled, fine, pyramid-shaped tothing, double-action		8393.283			
	21 mm	•		•	<b>83931857</b>
Grasping forceps, mono Ø 5 mm bndl fenestrated, with fine cross tothing, 15 mm long, single-action		8393.185			
	26 mm	•		•	<b>83931847</b>
Grasping forceps, mono Ø 5 mm bndl fenestrated, with fine cross tothing, 20 mm long, single-action		8393.184			
		8394.184	•	•	<b>83941847</b>

\* JL = jaw length when jaw section closed (approximate measurements)







HF connection cable: see sheet BDE116/117

III23 || Subject to modifications. Please note that some products may not be available in all countries. Please always take note of the information that is provided with the product. For more detailed information, please consult with your contact partner or directly with Richard Wolf GmbH.

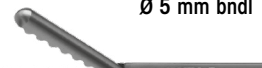

**ERAGON** modular

Ø 5.0 MM, INSULATED

Jaw insert			Sheath tube, Ø 5.0 mm, insulated			Handle, pistol-shaped			Complete instrument • Jaw insert with sheath tube • Handle
			SL 260 mm	SL 330 mm	SL 450 mm	with lock, without HF	without lock, with HF, mono	with lock, with HF, mono	
	JL*	Product no.	8392933	8393933	8394933	83930072	83930073	83930074	Product no.
 <b>Dolphin dissector forceps mono Ø 5 mm bndl</b> angled, with fine cross-toothing, with channel, narrow, 15 mm long, double-action	17 mm	8393.285		•			•		<b>83932857</b>
 <b>Dissector forceps mono Ø 5 mm bndl</b> fine pyramid-shaped toothing, narrow, 18 mm, double-action	23 mm	8393.289		•				•	<b>83932897</b>
 <b>Atraumatic grasping forceps Ø 5 mm bndl</b> Channel with wavy tooth edge, 20 mm, single-action	26 mm	8393.292		•			•		<b>83932925</b>
 <b>Atraumatic grasping forceps Ø 5 mm bndl</b> Channel with wavy tooth edge, 20 mm, double-action	26 mm	8393.293		•			•		<b>83932935</b>
		8394.293			•		•		<b>83942935</b>
 <b>Grasping forceps, mono Ø 5 mm bndl</b> fine, pyramid-shaped toothing, narrow double-action	19 mm	8393.288		•				•	<b>83932887</b>
 <b>Atraumatic grasping forceps mono Ø 5 mm bndl</b> fenestrated, with cross toothing, double-action	19 mm	8392.181	•					•	<b>83921817</b>
		8393.181		•				•	<b>83931817</b>
		8394.181			•			•	<b>83941817</b>

\* JL = jaw length when jaw section closed (approximate measurements)







HF connection cable: see sheet BDE116/117







11123 || Subject to modifications. Please note that some products may not be available in all countries. Please always take note of the information that is provided with the product. For more detailed information, please consult with your contact partner or directly with Richard Wolf GmbH.

**ERAGON** modular  
Ø 5.0 MM, INSULATED

ERAGONMODULAR

4

		Handle, axial			
 All jaw inserts and sheath tubes can also be combined with ERAGONaxial					
		with lock	without lock, with HF connector	without lock, with HF connector	with lock, not rotatable
<b>Rotatable knob</b>	<b>Product no.</b>	83930082	83930083	83930084	83930085
	8988	•	•	•	









Jaw insert		Sheath tube, Ø 5.0 mm, insulated		Handle, pistol-shaped		Complete instrument • Jaw insert with sheath tube • Handle	
							
	JL*	<b>Product no.</b>	SL 330 mm	SL 450 mm	with lock, without HF	without lock, with HF, mono	<b>Product no.</b>
	18 mm	8393.195	•			•	<b>83931957</b>
smooth, double-action		8394.195		•			•
	24 mm	8393.186	•			•	<b>83931867</b>
Gripping surface with fine cross tothing, double-action							
	26 mm	8393.187	•			•	<b>83931877</b>
large distal gripping surface with fine cross tothing, double-action		8394.187		•		•	
	39 mm	8393190	•			•	<b>83931907</b>
atraumatic clamp, double-action							

\* JL = jaw length when jaw section closed (approximate measurements)

HF connection cable: see sheet BDE50 1710

III23 || Subject to modifications. Please note that some products may not be available in all countries. Please always take note of the information that is provided with the product. For more detailed information, please consult with your contact partner or directly with Richard Wolf GmbH.

**ERAGON** modular  
Ø 5.0 MM, INSULATED

Jaw insert			Sheath tube, Ø 5.0 mm, insulated		Handle, pistol-shaped		Complete instrument • Jaw insert with sheath tube • Handle
							
			SL 330 mm	SL 450 mm	with lock, without HF	with lock, with HF, mono	
	JL*	Product no.	8393933	8394933	83930072	83930074	Product no.
 <b>Debaque forceps</b> Ø 5 mm bndl atraumatic clamp, double-action	48 mm	8393191	•		•		<b>83931917</b>
 <b>Grasping forceps, mono</b> Ø 5 mm bndl with a row of teeth, double-action	17 mm	8393.485	•			•	<b>83934857</b>
 <b>Grasping forceps, mono</b> Ø 5 mm bndl with one tooth, fine cross toothing, narrow, double-action	19 mm	8393.486	•			•	<b>83934867</b>
 <b>Grasping forceps, mono</b> Ø 5 mm bndl with two teeth, fine cross toothing, single-action	17 mm	8393.487	•			•	<b>83934877</b>
 <b>Grasping forceps</b> Ø 5 mm bndl with two teeth wavy gripping surface, double-action	26 mm	8393.490	•		•		<b>83934907</b>
		8394.490			•	•	<b>83944907</b>
 <b>Petelin dissector forceps</b> mono Ø 5 mm bndl angled 30° to the left, with cross toothing, single-action	17 mm	8393.282	•			•	<b>83932827</b>







\* JL = jaw length when jaw section closed (approximate measurements)









HF connection cable: see sheet BDE116/117

**ERAGON** modular  
Ø 5.0 MM, INSULATED

ERAGONMODULAR

4







		Handle, axial			
 All jaw inserts and sheath tubes can also be combined with <b>ERAGONaxial</b>					
		with lock	without lock, with HF connector	without lock, with HF connector	with lock, not rotatable
<b>Rotatable knob</b>	<b>Product no.</b>	83930082	83930083	83930084	83930085
	8988	•	•	•	

Jaw insert		Sheath tube, Ø 5.0 mm, insulated	Handle, pistol-shaped			Complete instrument	
		 SL 330 mm				• Jaw insert with sheath tube • Handle	
	JL*	<b>Product no.</b>	8393933	83930072	83930073	83930074	<b>Product no.</b>
 <b>Plate-shaped grasping forceps mono Ø 5 mm bndl</b> fenestrated with fine cross tothing, double-action	18 mm	8393.182	•			•	<b>83931827</b>
 <b>Grasping forceps mono Ø 5 mm bndl</b> with cross tothing, double-action	21 mm	8393.183	•		•		<b>83931837</b>
 <b>Grasping forceps mono Ø 5 mm bndl</b> distal cross tothing with channel, double-action	15 mm	8393.287	•		•		<b>83932877</b>
 <b>Claw grasping forceps Ø 5 mm bndl</b> double-action	27 mm	8393.494	•	•			<b>83934945</b>

\* JL = jaw length when jaw section closed (approximate measurements)

HF connection cable: see sheet BDE116/117

**ERAGON** modular  
Ø 5.0 MM, INSULATED

Jaw insert			Sheath tube, Ø 5.0 mm, insulated		Handle, pistol-shaped			Complete instrument • Jaw insert with sheath tube • Handle
			SL 330 mm	SL 450 mm	with lock, without HF	without lock, with HF, mono	with lock, with HF, mono	
	JL*	Product no.	8393933	8394933	83930072	83930073	83930074	Product no.
<b>Myoma grasping forceps</b> Ø 5 mm bndl  2x3-claw, single-action	29 mm	8393.488	•		•			<b>83934887</b>
<b>Universal grasping forceps mono</b> Ø 5 mm bndl  with pyramid-shaped tothing and cross tothing, double-action	18 mm	8393.481	•				•	<b>83934817</b>
<b>Universal grasping forceps</b> Ø 5 mm bndl  pyramid-shaped tothing and cross tothing, double-action	26 mm	8393.482	•		•			<b>83934827</b>
<b>Grasping forceps mono</b> Ø 5 mm bndl  Pike-mouth, double-action	20 mm	8393.483	•				•	<b>83934837</b>
<b>Biopsy forceps mono</b> Ø 5 mm bndl  with spikes, double-action	13 mm	8393.091	•				•	<b>83930917</b>
		8394.091		•		•		<b>83940917</b>
<b>Biopsy forceps mono</b> Ø 5 mm bndl  severing, single-action	14 mm	8393.092	•				•	<b>83930927</b>
		8394.092		•		•		<b>83940927</b>

\* JL = jaw length when jaw section closed (approximate measurements)







HF connection cable: see sheet BDE116/117







11123 || Subject to modifications. Please note that some products may not be available in all countries. Please always take note of the information that is provided with the product. For more detailed information, please consult with your contact partner or directly with Richard Wolf GmbH.

**ERAGON** modular  
Ø 5.0 MM, INSULATED

ERAGONMODULAR

4







		Handle, axial			
 All jaw inserts and sheath tubes can also be combined with ERAGONaxial					
		with lock	without lock, with HF connector	without lock, with HF connector	with lock, not rotatable
<b>Rotatable knob</b>	<b>Product no.</b>	83930082	83930083	83930084	83930085
	8988	•	•	•	

Jaw insert			Sheath tube, Ø 5.0 mm, insulated		Handle, pistol-shaped		Complete instrument • Jaw insert with sheath tube • Handle
 JL			SL 330 mm	SL 450 mm	 with lock, without HF	 without lock, with HF, mono	
	JL*	<b>Product no.</b>	8393933	8394933	83930072	83930073	<b>Product no.</b>
 <b>Biopsy forceps mono Ø 5 mm bndl</b> pointed spoon forceps, single-action	20 mm	8393.093	•			•	<b>83930937</b>
 <b>Knot pusher Ø 5 mm bndl</b> with distal recess, double-action	17 mm	8393.345	•		•		<b>83933457</b>
		8394.345		•			<b>83943457</b>
 <b>Grasping forceps Ø 5 mm bndl</b> spring jaw sections fenestrated with cross tothing, double-action	37 mm	8393.188	•		•		<b>83931887</b>
 <b>Grasping forceps Ø 5 mm bndl</b> spring jaw sections fenestrated with cross tothing, double-action	47 mm	8393.189	•		•		<b>83931897</b>
		8394.189		•			<b>83941897</b>

\* JL = jaw length when jaw section closed (approximate measurements)  
 HF connection cable: see sheet BDE116/117

III23 || Subject to modifications. Please note that some products may not be available in all countries. Please always take note of the information that is provided with the product. For more detailed information, please consult with your contact partner or directly with Richard Wolf GmbH.

**ERAGON** modular  
Ø 5.0 MM, INSULATED

Jaw insert			Sheath tube, Ø 5.0 mm, insulated		Handle, pistol-shaped		Complete instrument • Jaw insert with sheath tube • Handle
			SL 330 mm	SL450 mm	with lock, without HF	with lock, with HF, mono	
	JL*	Product no.	8393933	8394933	83930072	83930074	Product no.
 <b>Debaquey forceps</b> Ø 5 mm bndl atraumatic, spring jaw sections with cross toothing, double-action	47 mm	8393.291	•		•		<b>83932917</b>
 <b>Dissector forceps mono</b> Ø 5 mm bndl angled, double-action	18 mm	8393192	•			•	<b>83931927</b>
		8394192		•		•	<b>83941927</b>
 <b>Grasping forceps, mono</b> Ø 5 mm bndl double-action	16 mm	8393193	•		•		<b>83931937</b>
		8394193		•	•		<b>83941937</b>
 <b>Dissector forceps mono</b> Ø 5 mm bndl double-action	24 mm	8393194	•			•	<b>83931947</b>
		8394194		•		•	<b>83941947</b>
 <b>Dissector forceps mono</b> Ø 5 mm bndl double-action	30 mm	8393197	•			•	<b>83931977</b>
		8394197		•		•	<b>83941977</b>
 <b>Dissector forceps mono</b> Ø 5 mm bndl fine tips double-action	33 mm	8393198	•			•	<b>83931987</b>
		8394198		•		•	<b>83941987</b>







\* JL = jaw length when jaw section closed (approximate measurements)







HF connection cable: see sheet BDE116/117

**ERAGON** modular  
Ø 5.0 MM, INSULATED

ERAGONMODULAR

4

		Handle, axial			
 All jaw inserts and sheath tubes can also be combined with ERAGONaxial					
		with lock	without lock, with HF connector	without lock, with HF connector	with lock, not rotatable
Rotatable knob	Product no.	83930082	83930083	83930084	83930085
	8988	•	•	•	

Jaw insert		Sheath tube, Ø 5.0 mm, insulated		Handle, pistol-shaped	Complete instrument
					• Jaw insert with sheath tube • Handle
	JL*	SL 330 mm	SL 450 mm	with lock, with HF, mono	Product no.
	Product no.	8393933	8394933	83930074	
 Dissector forceps mono Ø 5 mm bndl 32 mm double-action	8393199	•		•	<b>83931997</b>
	8394199		•	•	<b>83941997</b>
 Dissector forceps mono Ø 5 mm bndl 19 mm fine tip, double-action	8393200	•		•	<b>83932007</b>
	8394200		•	•	<b>83942007</b>
 Atraumatic grasping forceps mono Ø 5 mm bndl 16 mm atraumatic, with cross toothing, double-action	8393210	•		•	<b>83932107</b>
	8393220	•		•	<b>83932207</b>
 Atraumatic grasping forceps mono Ø 5 mm bndl 19mm atraumatic, with cross toothing, double-action	8393220	•		•	<b>83932207</b>
	8394220		•	•	<b>83942207</b>









\* JL = jaw length when jaw section closed (approximate measurements)  
 HF connection cable: see sheet BDE116/117

11123 || Subject to modifications. Please note that some products may not be available in all countries. Please always take note of the information that is provided with the product. For more detailed information, please consult with your contact partner or directly with Richard Wolf GmbH.



**ERAGON** modular

Ø 5.0 MM, INSULATED

Jaw insert			Sheath tube, Ø 5.0 mm, insulated		Handle, pistol-shaped		Complete instrument • Jaw insert with sheath tube • Handle
							
			SL 330 mm	SL 450 mm	with lock, without HF	with lock, with HF, mono	
	JL*	Product no.:	8393933	8394933	83930072	83930074	Product no.:
 <b>Atraumatic grasping forceps Ø 5 mm bndl</b> atraumatic, with pyramid-shaped tothing and cross tothing, double-action	29 mm	8393223	•		•		83932237
		8394223		•	•		83942237
 <b>Atraumatic grasping forceps Ø 5 mm bndl</b> atraumatic, single fenestrated with cross tothing, double-action	25 mm	8393250	•		•		83932507
		8394250		•	•		83942507
 <b>Atraumatic grasping forceps Ø 5 mm bndl</b> atraumatic, double fenestrated and curved single-action	32 mm	8393229	•		•		83932297
		8394229		•	•		83942297
 <b>Grasping forceps Ø 5 mm bndl</b> atraumatic, narrow and rounded, double-action	15 mm	8393230	•		•		83932307
		8394230		•	•		83942307
 <b>Dissector forceps mono Ø 5 mm bndl</b> curved, double-action	19 mm	8393240	•			•	83932407
		8394240		•		•	83942407
 <b>Dissector forceps mono Ø 5 mm bndl</b> single fenestrated double-action	17 mm	8393242	•		•		83932427
		8394242		•	•		83942427







\* JL = jaw length when jaw section closed (approximate measurements)





HF connection cable: see sheet BDE116/117

**ERAGON** modular  
Ø 5.0 MM, INSULATED

ERAGONMODULAR

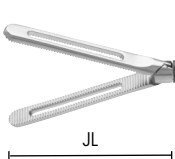
4

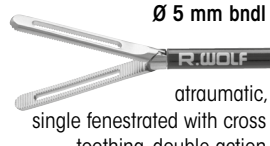

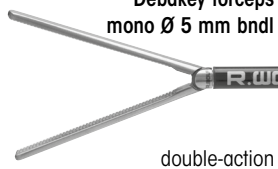





		Handle, axial			
 All jaw inserts and sheath tubes can also be combined with ERAGONaxial					
		with lock	without lock, with HF connector	without lock, with HF connector	with lock, not rotatable
Rotatable knob	Product no.	83930082	83930083	83930084	83930085
	8988	•	•	•	

Jaw insert			Sheath tube, Ø 5.0 mm, insulated		Handle, pistol-shaped		Complete instrument • Jaw insert with sheath tube • Handle
							
	JL*	Product no.	SL 330 mm	SL 450 mm	with lock, without HF	with lock, with HF, mono	Product no.
 Intestine grasping forceps Ø 5 mm bndl atraumatic, single fenestrated with cross tooting, double-action	38 mm	8393249	•		•		<b>83932497</b>
		8394249		•	•		<b>83942497</b>
 Debakey forceps mono Ø 5 mm bndl curved, double-action	35 mm	8393256	•			•	<b>83932567</b>
		8393258	•			•	<b>83932587</b>
 Debakey forceps mono Ø 5 mm bndl double-action	47 mm	8394258		•		•	<b>83942587</b>

\* JL = jaw length when jaw section closed (approximate measurements)  
 HF connection cable: see sheet BDE116/117

**ERAGON** modular

Ø 5.0 MM, INSULATED

Jaw insert			Sheath tube, Ø 5.0 mm, insulated		Handle, pistol-shaped	Complete instrument • Jaw insert with sheath tube • Handle
						
			SL 330 mm	SL 450 mm	without lock, with HF, mono	
	JL*	Product no.	8393933	8394933	83930073	Product no.
 <b>Metzenbaum scissors mono Ø 5 mm bndl</b> 23 mm		8393.041	•		•	<b>83930417</b>
		8394.041		•		•
 <b>Metzenbaum micro scissors mono Ø 5 mm bndl</b> 18 mm		8393.044	•		•	<b>83930447</b>
 <b>Scissors mono Ø 5 mm bndl</b> 20 mm		8393.045	•		•	<b>83930457</b>
 <b>Hook scissors mono Ø 5 mm bndl</b> 14 mm		8393.081	•		•	<b>83930817</b>
		8394.081		•		•
 <b>Metzenbaum micro scissors mono Ø 5 mm bndl</b> 21 mm		8393243	•		•	<b>83932437</b>
		8394243		•		•
 <b>Scissors mono Ø 5 mm bndl</b> 26 mm		8393246	•		•	<b>83932467</b>
		8394246		•		•







\* JL = jaw length when jaw section closed (approximate measurements)







HF connection cable: see sheet BDE116/117

**ERAGON<sup>modular</sup>**  
 Ø 5.0 MM, INSULATED

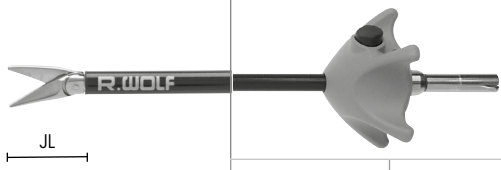
ERAGONMODULAR

4

		Handle, axial			
 All jaw inserts and sheath tubes can also be combined with ERAGONaxial					
		with lock	without lock, with HF connector	without lock, with HF connector	with lock, not rotatable
Rotatable knob	Product no.	83930082	83930083	83930084	83930085
	8988	•	•	•	

Jaw insert		Sheath tube, Ø 5.0 mm, insulated		Handle, pistol-shaped		Complete instrument	
 JL						• Jaw insert with sheath tube • Handle	
		SL 330 mm	SL 450 mm	with lock, without HF	without lock, with HF, mono		
	JL*	Product no.	8393933	8394933	83930072	83930073	Product no.
 <b>Scissors mono Ø 5 mm bndl</b> 22 mm		8393248	•			•	<b>83932487</b>
	fine-toothed, fine tip double-action	8394248		•		•	<b>83942487</b>
 <b>Knot pusher Ø 5 mm bndl</b> 17 mm		8393.345	•			•	<b>83933457</b>
	with distal recess, double-action	8394345		•		•	<b>83943457</b>
 <b>Gastric band manipulator Ø 5 mm bndl</b> 47 mm		8393253	•			•	<b>83932537</b>
	90° articulating with distal slot	8394253		•		•	<b>83942537</b>



\* JL = jaw length when jaw section closed (approximate measurements)

HF connection cable: see sheet BDE116/117

Accessories for manual and machine reprocessing		Product no.
	<b>Irrigation adapter</b> Ø 9 mm, length 64 mm	<b>163502</b>

III23 || Subject to modifications. Please note that some products may not be available in all countries. Please always take note of the information that is provided with the product. For more detailed information, please consult with your contact partner or directly with Richard Wolf GmbH.

**ERAGON<sup>modu</sup> blades**  
 Ø 5.0 MM, INSULATED

 All jaw inserts and sheath tubes can also be combined with <b>ERAGONaxial</b>		 without lock, with HF connector		
		<b>Rotatable knob</b>	<b>Product no.</b>	83930083
		8988	•	

Scissors attachment		Tension rod Ø 5.0 mm			Sheath tube insulated Ø 5.0 mm			Handle pistol-shaped	Complete instrument • Jaw insert with sheath tube • Handle
									
		for SL 260 mm	for SL 330 mm	for SL 450 mm	SL 240 mm	SL 310 mm	SL 430 mm	without lock, rotatable with HF connector	
	<b>Product no.</b>	8392934	8393934	8394934	8392935	8393935	8394935	83930073	<b>Product no.</b>
<b>Metzenbaum scissors attachment mono</b> 		•			•			•	<b>83920407</b>
4393040 (PACK= 10 PCS), sterile, disposable			•			•		•	<b>83930407</b>
				•			•	•	<b>83940407</b>











HF connection cable: see sheet BDE116/117

III23 || Subject to modifications. Please note that some products may not be available in all countries. Please always take note of the information that is provided with the product. For more detailed information, please consult with your contact partner or directly with Richard Wolf GmbH.

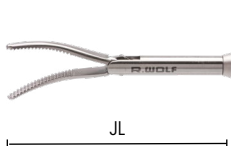
**ERAGON** modular

Ø 10 MM, UNINSULATED

		Handle, axial	
<b>ERAGON</b> axial			
All jaw inserts and sheath tubes can also be combined with <b>ERAGON</b> axial		with lock, without HF connector	with lock, without HF connector, not rotatable
<b>Rotatable knob</b>	<b>Product no.</b>	83930082	83930085
	8988	.	.







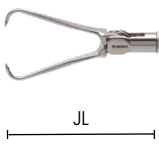

Jaw insert		Sheath tube, Ø 10.0 mm, uninsulated		Handle, pistol-shaped	Complete instrument
					<ul style="list-style-type: none"> <li>• Jaw insert with sheath tube</li> <li>• Handle</li> </ul>
		SL 327 mm	SL 447 mm	with lock, without HF	
	<b>JL*</b>	<b>Product no.</b>	8395902	8396902	<b>Product no.</b>
	36 mm	8395.225	.	.	<b>83952257</b>
double-action		8396225	.	.	<b>83962257</b>
	35 mm	8395.226	.	.	<b>83952268</b>
angled, double-action		8396226	.	.	<b>83962267</b>
	20 mm	8395.236	.	.	<b>83952368</b>
Pike-mouth double-action		8396236	.	.	<b>83962367</b>
	49 mm	8395.204	.	.	<b>83952048</b>
2/3 jaws single-action		8396204	.	.	<b>83962047</b>

\* JL = jaw length when jaw section closed (approximate measurements)

HF connection cable: see sheet BDE116/117

||| Subject to modifications. Please note that some products may not be available in all countries. Please always take note of the information that is provided with the product. For more detailed information, please consult with your contact partner or directly with Richard Wolf GmbH.



**ERAGON** modular  
Ø 10 MM, UNINSULATED





Jaw insert			Sheath tube, Ø 10.0 mm, uninsulated			Handle, pistol-shaped		Complete instrument • Jaw insert with sheath tube • Handle
			SL 327 mm	SL 447 mm	SL 387 mm	with lock, without HF		
	JL*	Product no.	8395902	8396902	8397902	83930072	83930082	Product no.
 Claw grasping forceps Ø 10 mm bndl double-action	38 mm	8395.489	•			•		83954897
 Claw grasping forceps Ø 10 mm bndl with additional row of teeth, double-action	38 mm	8395490	•			•		83954907
 Babcock forceps Ø 10 mm bndl large distal gripping surface with fine cross toothing, double-action	42 mm	8395.187	•			•		83951877
		8396187		•		•		83961877
 Babcock forceps Ø 10 mm bndl double-action	38 mm	8395.214	•			•		83952148
 Plate-shaped grasping forceps Ø 10 mm bndl double-action	50 mm	8395.234	•			•		83952347
		8396234		•		•		83962347
 Spoon forceps Ø 10 mm bndl single-action	31 mm	8395.244	•			•		83952448
 Stapler head grasping forceps Ø 10 mm bndl angled 30°, double-action		8397.655			•		•	83976558

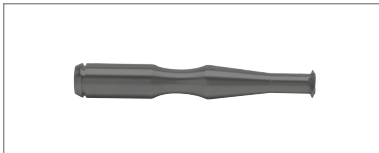

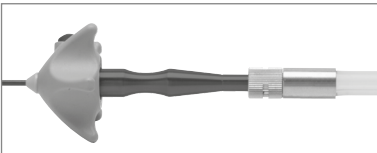

\* JL = jaw length when jaw section closed (approximate measurements)/HF connection cable: see sheet BDE116/117

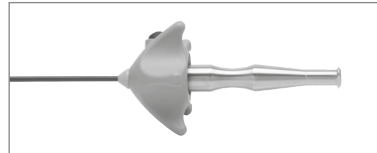
11123 || Subject to modifications. Please note that some products may not be available in all countries. Please always take note of the information that is provided with the product. For more detailed information, please consult with your contact partner or directly with Richard Wolf GmbH.

**ERAGON** modular  
ACCESSORIES

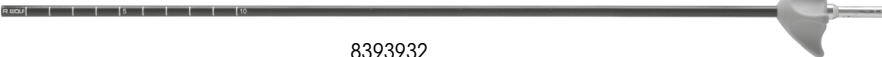
For insulated sheath tubes		Product no.
	For manual and machine reprocessing:  <b>Irrigation adapter</b> Ø 9 mm, length 64 mm for insulated sheath tubes	<b>163502</b>
		

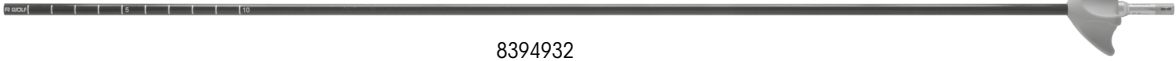
For uninsulated sheath tubes		Product no.
	For manual and machine reprocessing:  <b>Irrigation adapter cleaning</b> Ø 9 mm, length 64 mm for uninsulated sheath tubes	<b>163503</b>
		





	<b>8393932</b>	
	<b>8394932</b>	





		Ø	SL	Product no.
ERAGONmodular	<b>Sheath tube insulated Ø 5 mm SL 330 mm</b> with distal cm scale	5 mm	330 mm	<b>8393932</b>
	<b>Sheath tube insulated Ø 5 mm SL 450 mm</b> with distal cm scale	5 mm	450 mm	<b>8394932</b>



III23 || Subject to modifications. Please note that some products may not be available in all countries. Please always take note of the information that is provided with the product. For more detailed information, please consult with your contact partner or directly with Richard Wolf GmbH.



## HANDLE VARIANTS FOR MODULAR SYSTEMS

Handle, pistol-shaped 	rotatable	with lock	without lock	with HF	without HF	Product no.
	•	•			•	83930072
	•		•	•		83930073
	•	•		•		83930074

Handle, axial 	rotatable	with lock	without lock	with HF	without HF	Product no.
	•	•			•	83930082
	•		•	•		83930083
	•	•		•		83930084
		•			•	83930085

Optional for 83930082/83930083/83930084:		Product no.
 	Rotatable knob autoclavable	8988

All ERAGON<sup>modular</sup> components are compatible with ERAGON<sup>axial</sup>

# CHOLANGIOGRAPHY CATHETERGRASPING FORCEPS 5 MM

FORCEPS

5

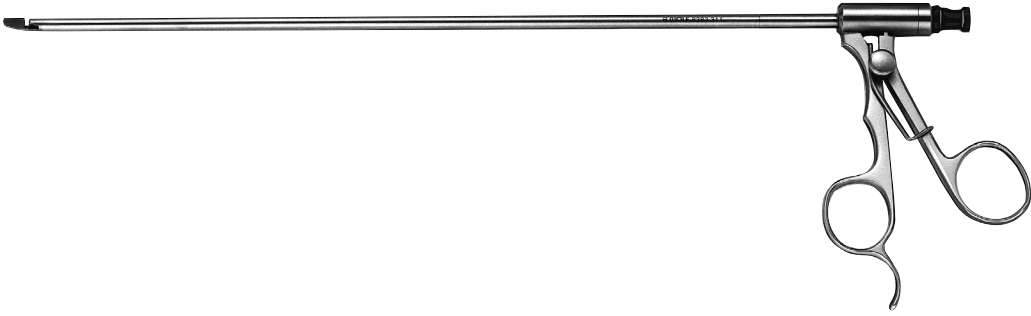







		Outer Ø	WL	Product no.
	Grasping forceps Ø 5 mm WL 295 mm	5.0 mm	295 mm	<b>8383.311</b>

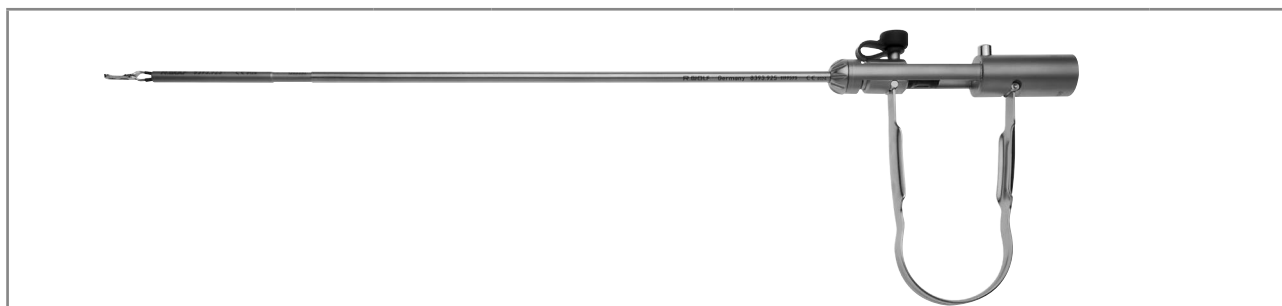

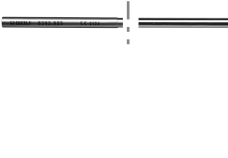

- For inserting a cholangiography catheter up to 7 Fr into the cystic duct

# BIPOLAR FORCEPS 3.5 MM/5.0 MM

WITH SPRING HANDLE  
MODULAR SYSTEM









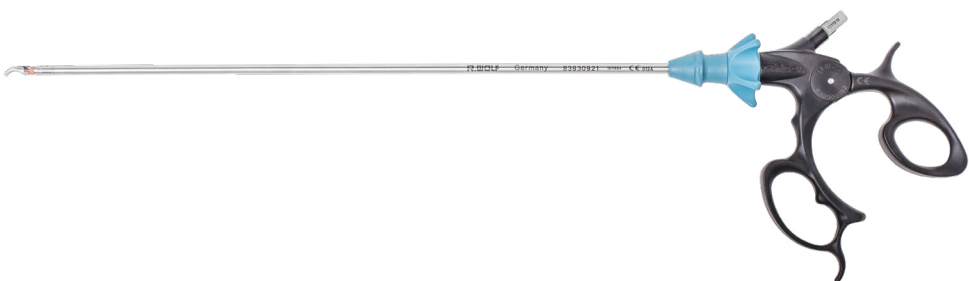

Grasping forceps jaw insert			Outer tube Ø 3.5 mm SL 348 mm	Screw cap with sleeve Ø 5.0 mm SL 107 mm	Spring handle bipo	complete instrument • Jaw insert • Sliding sleeve • Outer tube • Spring handle
						
	JL*	Product no.	8391.921	8393.978	8393.975	Product no.
	39 mm	8391.715	•	•	•	<b>8391.742</b>

Kleppinger grasping forceps jaw insert			Sliding sleeve SL 319 mm	Outer tube Ø 5 mm SL 237 mm	Spring handle bipo	complete instrument • Jaw insert • Sliding sleeve • Outer tube • Spring handle
						
	JL*	Product no.	8393.923	8393.925	8393.975	Product no.
	53 mm	8393.714	•	•	•	<b>8393.741</b>

Accessories	Product no.
RIWO rubber cap, jet black	15220.019
Luer sealing cap	15023.153

\* JL = jaw length when jaw section closed (approximate measurements)  
Bipolar connection cable: see sheet BDE118/119





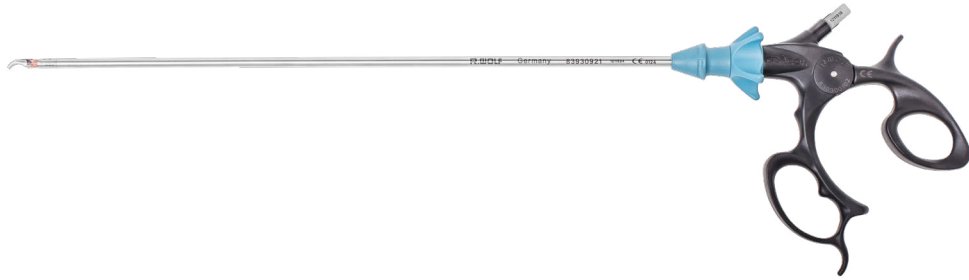

**ERAGON** bipolar  
MODULAR BIPOLAR INSTRUMENTS, 5.5 MM  
ROTATABLE

						
Jaw insert			Sheath tube Ø 5.5 mm		Handle, pistol-shaped, bipo	Complete instrument • Jaw insert • Sheath tube • Handle
						
			SL 320 mm	SL 435 mm	rotatable	
	JL*	Product no.	83930921	82340024	839300102	Product no.
	21 mm	83930031	•		•	<b>839300312</b>
		839400310			•	<b>839400312</b>
	23 mm	83930032	•		•	<b>839300322</b>
		839400320			•	<b>839400322</b>
	21 mm	83930033	•		•	<b>839300332</b>
		839400330			•	<b>839400332</b>
	23 mm	83930034	•		•	<b>839300342</b>
		839400340			•	<b>839400342</b>
	19 mm	83930035	•		•	<b>839300352</b>
		839400350			•	<b>839400352</b>

\* JL = jaw length when jaw section closed (approximate measurements)  
Bipolar connection cable: see sheet BDE118/119

**ERAGON** bipolar  
MODULAR BIPOLAR INSTRUMENTS, 5.5 MM,  
ROTATABLE



Jaw insert			Sheath tube Ø 5.5 mm		Handle, pistol-shaped, bipo	Complete instrument • Jaw insert • Sheath tube • Handle
						
			SL 320 mm	SL 435 mm	rotatable	
	JL*	Product no.	83930921	82340024	839300102	Product no.
	19 mm	83930036	•		•	839300362
	22 mm	83930037	•		•	839300372
		83930038	•		•	839300382
	15 mm	839400380		•	•	839400382
	22 mm	83930041	•		•	839300412
		839400410		•	•	839400412



\* JL = jaw length when jaw section closed (approximate measurements)  
Bipolar connection cable: see sheet BDE118/119

11123 || Subject to modifications. Please note that some products may not be available in all countries. Please always take note of the information that is provided with the product. For more detailed information, please consult with your contact partner or directly with Richard Wolf GmbH.





# ELECTRODES 2.0 MM/3.5 MM

## MONOPOLAR



		Outer Ø	WL	Product no.
	Coagulation electrode mono 5 FR WL 400 mm	1.67 mm	400 mm	<b>823.05</b>
	Coagulation electrode mono 6 FR WL 400 mm	2.0 mm	400 mm	<b>823.06</b>





		Outer Ø	WL	Product no.
	Hook electrode mono Ø 3.5 mm WL 310 mm	3.5 mm	310 mm	<b>8379.452</b>
	Hook electrode mono Ø 3.5 mm WL 240 mm with distally extended insulation	3.5 mm	240 mm	<b>8785.642</b>
	Needle electrode mono Ø 3.5 mm WL 310 mm	3.5 mm	310 mm	<b>8379.482</b>
	Coagulation electrode mono Ø 3.5 mm WL 310 mm	3.5 mm	310 mm	<b>8379.462</b>

HF connection cable: see sheet BDE116/117





# ELECTRODES 5.0 MM

## MONOPOLAR



		Outer Ø	WL	Product no.
	Coagulation electrode mono Ø 5 mm WL 330 mm	5.0 mm	330 mm	<b>8383.40</b>
	Coagulation electrode mono Ø 5 mm WL 450 mm	5.0 mm	450 mm	<b>8384.40</b>



		Outer Ø	WL	Product no.
	Hook electrode mono Ø 5 mm WL 340 mm	5.0 mm	340 mm	<b>8383.423</b>
	Hook electrode mono Ø 5 mm WL 420 mm		420 mm	<b>8384.423</b>
	Needle electrode mono Ø 5 mm WL 340 mm	5.0 mm	340 mm	<b>8383.426</b>
	Spatula electrode mono Ø 5 mm WL 340 mm	5.0 mm	340 mm	<b>8383.428</b>
	Myoma dissector mono Ø 5 mm WL 340 mm	5.0 mm	340 mm	<b>8383429</b>

HF connection cable: see sheet BDE116/117

# MULTIFUNCTIONAL SUCTION IRRIGATION SYSTEM

## COMBINATION OPTIONS

MULTIFUNCTIONAL SUCTION IRRIGATION SYSTEM

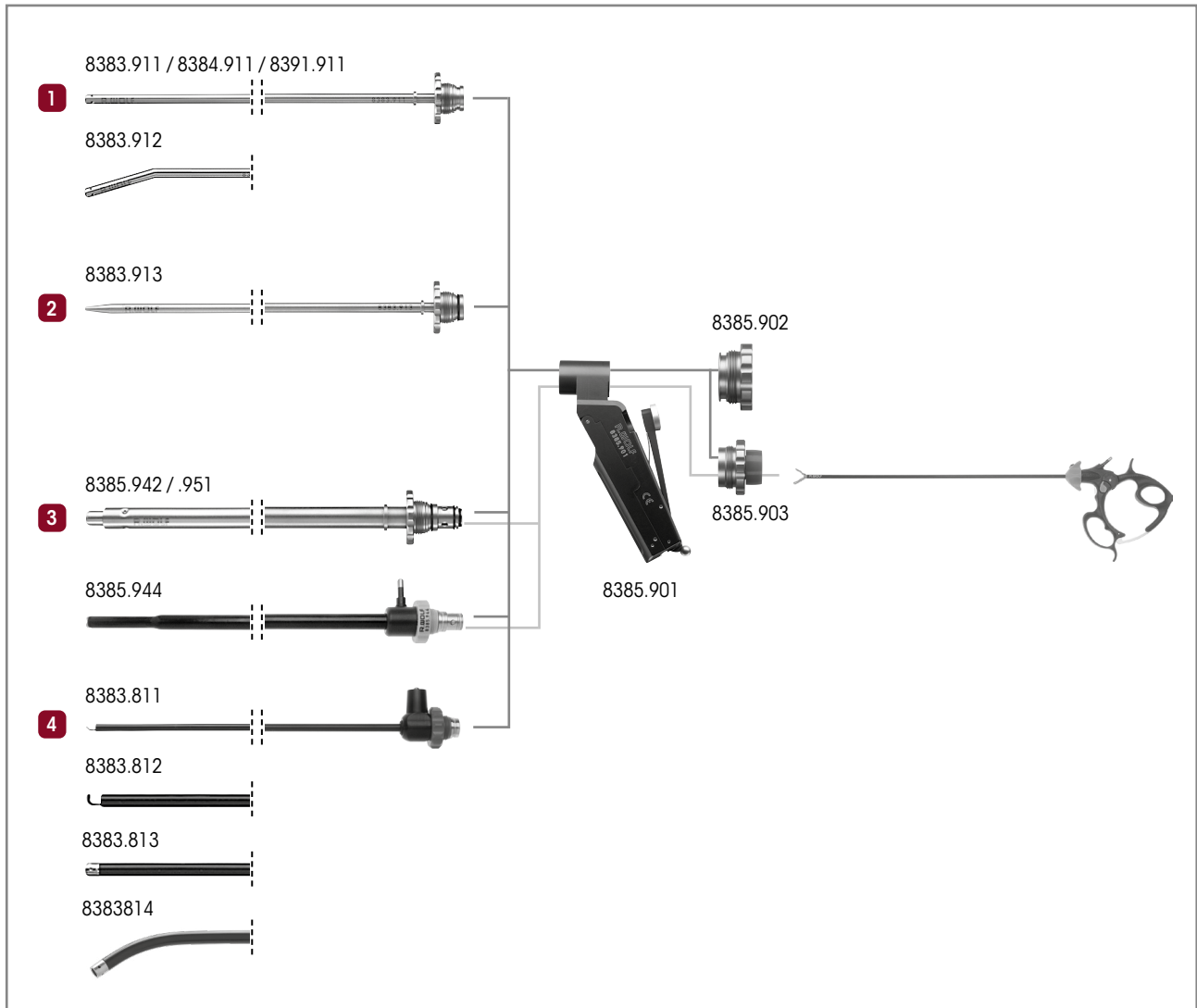

- 1 Suction or irrigation:**
- Suction irrigation tube Ø 5 mm WL 310 mm ..... 8383.911
  - Suction irrigation tube Ø 5 mm WL 450 mm ..... 8384.911
  - Suction irrigation tube Ø 3.5 mm WL 300 mm ..... 8391.911
  - Suction irrigation tube curved Ø 5 mm WL 310 mm... 8383.912
  - for this: **Sealing cap** ..... 8385.902

- 2 Blunt aquadissection:**
- Pressure irrigation tube Ø 5 mm WL 310 mm ..... 8383.913
  - for this: **Sealing cap** ..... 8385.902

- 3 Suction, irrigation, and use of auxiliary instruments Ø 5 mm:**
- Suction irrigation tube Ø 10 mm WL 225 mm ..... 8385.942
  - Suction irrigation tube Ø 10 mm WL 330 mm ..... 8385.951
  - Suction irrigation tube Ø mono 10 mm WL 330 mm, insulated, with atraumatic preparation tip ..... 8385.944
  - for this: **Sealing adapter** ..... 8385.903

- 4 Preparation of tissue with HF:**
- HF suction irrigation tube Ø 5.2 mm WL 317 mm insulated with integrated HF spatula probe** ..... 8383.811
  - HF suction irrigation tube Ø 5.2 mm WL 317 mm insulated with integrated HF hook electrode** ..... 8383.812
  - HF suction irrigation tube Ø 5.2 mm WL 317 mm insulated with integrated HF button electrode** ..... 8383.813
  - HF suction irrigation tube Ø 5.4 mm WL 380 mm curved with distal openings, insulated with integrated HF button electrode** ..... 8383.814
  - for this: **Sealing cap** ..... 8385.902

III23 || Subject to modifications. Please note that some products may not be available in all countries. Please always take note of the information that is provided with the product. For more detailed information, please consult with your contact partner or directly with Richard Wolf GmbH.



# MULTIFUNCTIONAL SUCTION IRRIGATION SYSTEM

## SUCTION IRRIGATION HANDLE

 <p>8385.901</p> <p><b>AUTOGLAVE</b> <b>134° C / 273° F</b></p> <p>8385.902</p> <p>8385.903</p>	
Product no.	
Suction irrigation handle	<b>8385.901</b>
Sealing cap	<b>8385.902</b>
Required to use auxiliary instruments Ø 5 mm: Sealing attachment with opening and membrane valve	<b>8385.903</b>
Spare Sealing membrane Ø 17 mm yellow, Ø 17 mm, PACK= 10 PCS, for instruments from 3 to 6 mm	<b>89.103</b>

# MULTIFUNCTIONAL SUCTION IRRIGATION SYSTEM

## SUCTION IRRIGATION TUBE SETS – ILLUSTRATION

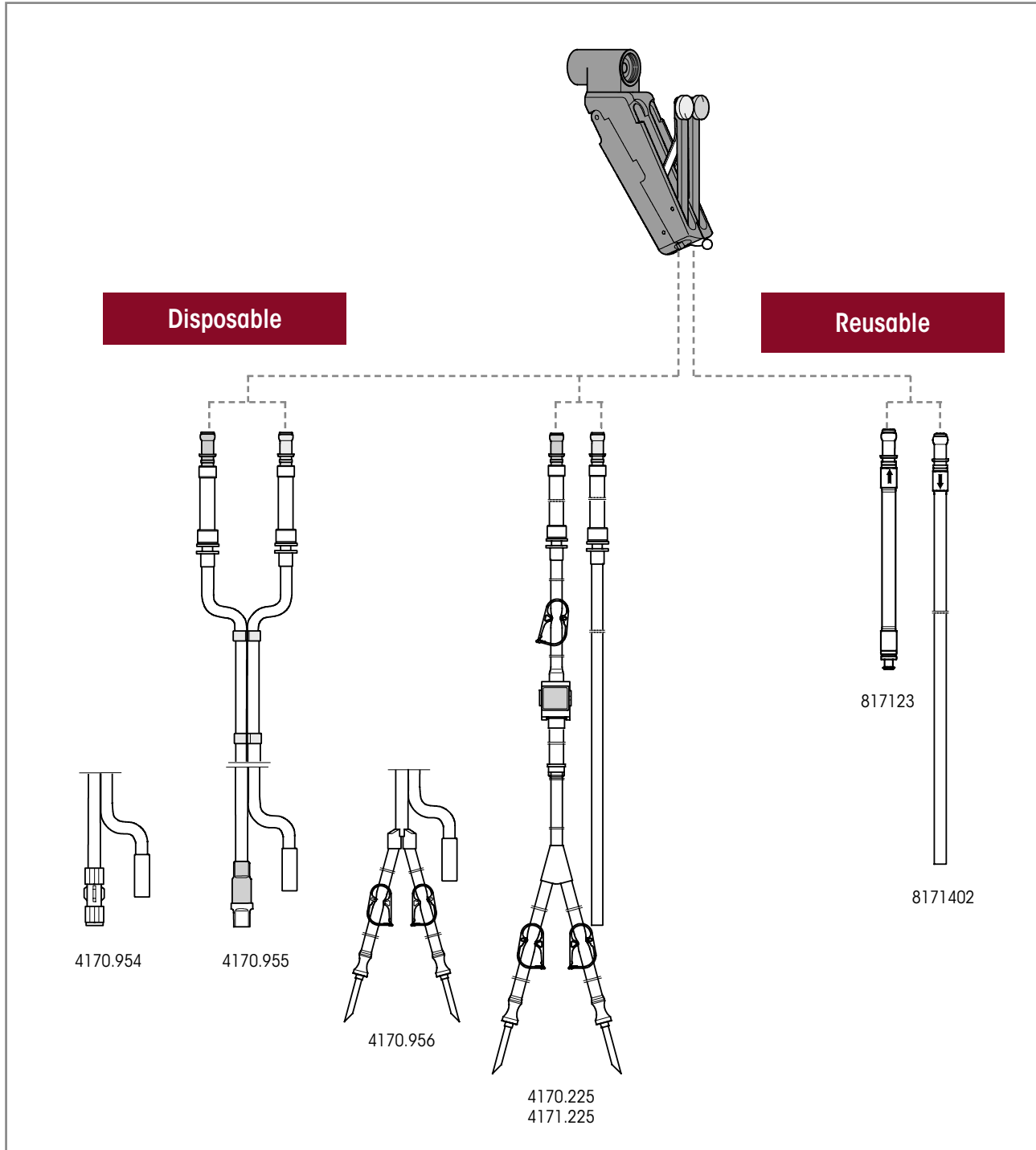

**Suction irrigation tube sets** are used in conjunction with the suction irrigation handle 8385.901 and pump-side tube systems as well as corresponding collection and secretion containers and/or vacuum pumps (e.g., FLUID CONTROL LAP 2216, LAPARO PUMP 2215)







# MULTIFUNCTIONAL SUCTION IRRIGATION SYSTEM

## SUCTION IRRIGATION TUBE SETS FOR SUCTION IRRIGATION HANDLE 8385.901

Disposable		Product no.
<b>Suction irrigation tube set, L 3 m</b>  (PACK= 10 PCS), sterile	<b>Irrigation tube:</b> With Luer-Lock, for connection to the irrigation tube of a suction irrigation tube set, e.g., irrigation tube of the Endo-Irrigator 2211 <b>Suction tube:</b> For connection to a collection or secretion container and/or vacuum pump	<b>4170.954</b>
<b>Suction irrigation tube set with care-lock, L 3 m</b>  (PACK= 10 PCS), sterile	<b>Irrigation tube:</b> With CARE-LOCK, for connection to an irrigation container <b>Suction tube:</b> For connection to a collection or secretion container and/or vacuum pump	<b>4170.955</b>
<b>Suction irrigation tube set with piercing spike, L 3 m</b>  (PACK= 10 PCS), sterile	<b>Irrigation tube:</b> With 2 piercing spikes, for connection to an irrigation container <b>Suction tube:</b> For connection to a collection or secretion container and/or vacuum pump	<b>4170.956</b>
<b>Suction irrigation tube set with piercing spike, L 3 m</b>  (PACK= 10 PCS), sterile	<b>Irrigation tube:</b> With 2 piercing spikes, for connection to an irrigation container, plus Laparo Pump 2215 and Fluid Control Lap 2216 <b>Suction tube:</b> For connection to a collection or secretion container and/or vacuum pump  Also observe instruction manual GA-A 167	<b>4170.225</b>
<b>Suction irrigation tube set, L 3 m</b>  (PACK= 10 PCS), sterile	<b>Irrigation tube:</b> With 2 piercing spikes, for connection to an irrigation container, and Fluid Control Lap 2216 <b>Suction tube:</b> For connection to a collection or secretion container and/or vacuum pump  Also observe instruction manual GA-A 276	<b>4171.225</b>
<b>Secretion container, 2.5 l</b>	2.5 liters	<b>41706566</b>
<b>Tube set for suction (2 connections)</b>	sterile disposable product (PACK= 10 PCS), for connecting instruments to collecting container	<b>T0503-01</b>
Reusable		Product no.
<b>Irrigation tube L 1.2 m</b>	<b>Irrigation tube:</b> With Luer-Lockconnection for connection to the irrigation tube of a suction irrigation tube set, e.g., 8171223 or 8170.223	<b>817123</b>
<b>Suction tube L 3 m</b>	silicone, for suction irrigation handle 8385.901	<b>8171402</b>
<b>Secretion container, 2 l</b>	2 liters, with lid	<b>8170.655</b>
<b>Secretion container, 2 l</b>	2 liters, no lid	<b>8170.6551</b>

# MULTIFUNCTIONAL SUCTION IRRIGATION SYSTEM

## SUCTION IRRIGATION TUBES





		Outer Ø	WL	Product no.
				
	Suction irrigation tube Ø 3.5 mm WL 300 mm	3.5 mm	300 mm	<b>8391.911</b>
	Suction irrigation tube Ø 5 mm WL 310 mm	5.0 mm	310 mm	<b>8383.911</b>
	Suction irrigation tube Ø 5 mm WL 450 mm	5.0 mm	450 mm	<b>8384.911</b>
	Suction irrigation tube curved Ø 5 mm WL 310 mm	5.0 mm	310 mm	<b>8383.912</b>
	Pressure irrigation tube Ø 5 mm WL 310 mm	5.0 mm	310 mm	<b>8383.913</b>
for use of 5 mm auxiliary instruments				
 capacity 5.0 mm	Suction irrigation tube Ø 10 mm WL 225 mm	10.0 mm	225 mm	<b>8385.942</b>
	Suction irrigation tube Ø 10 mm WL 330 mm	10.0 mm	330 mm	<b>8385.951</b>
 insulated, with atraumatic preparation tip	Suction irrigation tube mono Ø 10 mm WL 330 mm	10.0 mm	330 mm	<b>8385.944</b>
	required for 8385.951:  <b>Sealing attachment</b> with opening and membrane valve Sealing membrane Ø 17 mm			<b>8385.903</b>

III23 || Subject to modifications. Please note that some products may not be available in all countries. Please always take note of the information that is provided with the product. For more detailed information, please consult with your contact partner or directly with Richard Wolf GmbH.

# MULTIFUNCTIONAL SUCTION IRRIGATION SYSTEM

## SUCTION IRRIGATION TUBES



		Outer Ø	WL	Product no.
 insulated with integrated HF spatula probe	<b>HF suction irrigation tube Ø 5.2 mm WL 317 mm</b>	5.2 mm	317 mm	<b>8383.811</b>
 insulated with integrated HF hook probe	<b>HF suction irrigation tube Ø 5.2 mm WL 317 mm</b>	5.2 mm	317 mm	<b>8383.812</b>
 insulated with integrated HF button electrode	<b>Suction irrigation tube Ø 5 mm WL 450 mm</b>	5 mm	317 mm	<b>8383.813</b>
as alternative to suction irrigation handle:				
	<b>Suction irrigation adapter</b> with maintenance-free two-way stopcock, for multifunctional suction irrigation system			<b>8583819</b>







Accessories	Product no.
HF connection cable	See page BDE116/117

# MULTIFUNCTIONAL SUCTION IRRIGATION SYSTEM

## SUCTION IRRIGATION TUBES

MULTIFUNCTIONAL SUCTION IRRIGATION SYSTEM

8

				
		Outer Ø	WL	Product no.
	Suction tube OD 2.8 mm WL 450 mm	2.8 mm	450 mm	<b>8380.68</b>
	Suction irrigation tube Ø 5 mm WL 310 mm	5.0 mm	310 mm	<b>8383.911</b>
	Suction irrigation tube Ø 5 mm WL 450 mm	5.0 mm	450 mm	<b>8384.911</b>
	Suction irrigation tube curved Ø 5 mm WL 310 mm	5.0 mm	310 mm	<b>8383.912</b>
	Pressure irrigation tube Ø 5 mm WL 310 mm	5.0 mm	310 mm	<b>8383.913</b>
for use of 5 mm auxiliary instruments				
 capacity 5.0 mm	Suction irrigation tube Ø 10 mm WL 225 mm	10.0 mm	225 mm	<b>8385.942</b>
	Suction irrigation tube Ø 10 mm WL 330 mm	10.0 mm	330 mm	<b>8385.951</b>
 insulated, with atraumatic preparation tip	Suction irrigation tube mono Ø 10 mm WL 330 mm	10.0 mm	330 mm	<b>8385.944</b>
	required for 8385.951:  <b>Sealing attachment</b> with opening and membrane valve, sealing membrane Ø 17 mm			<b>8385.903</b>

III23 || Subject to modifications. Please note that some products may not be available in all countries. Please always take note of the information that is provided with the product. For more detailed information, please consult with your contact partner or directly with Richard Wolf GmbH.

## ACCESSORIES FOR SUCTION AND IRRIGATION

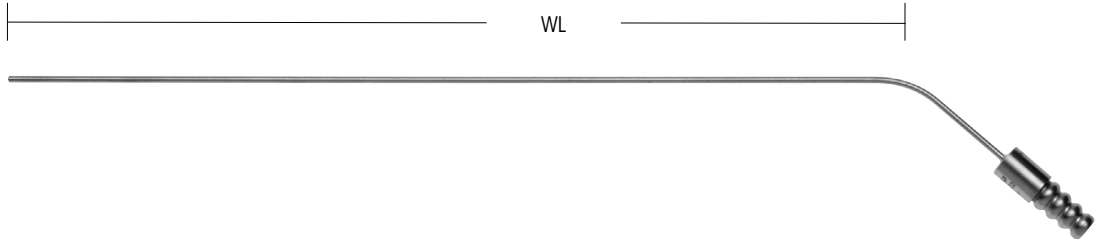

		Outer Ø	WL	Product no.
 central, lateral openings, rigid	suction tube OD 2 mm WL 250 mm	2.0 mm	250 mm	<b>8291.22</b>
	suction tube OD 2.5 mm WL 250 mm	2.5 mm	250 mm	<b>8291.23</b>
	suction tube OD 3 mm WL 250 mm	3.0 mm	250 mm	<b>8291.24</b>
	suction tube OD 4 mm WL 500 mm	4.0 mm	500 mm	<b>8291.45</b>



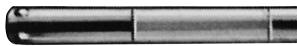



		Outer Ø	WL	Product no.
	Suction tube OD 2.8 mm WL 450 mm	2.8 mm	450 mm	<b>8380.68</b>

11123 || Subject to modifications. Please note that some products may not be available in all countries. Please always take note of the information that is provided with the product. For more detailed information, please consult with your contact partner or directly with Richard Wolf GmbH.

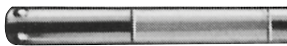
**ACCESSORIES**  
FOR SUCTION AND IRRIGATION

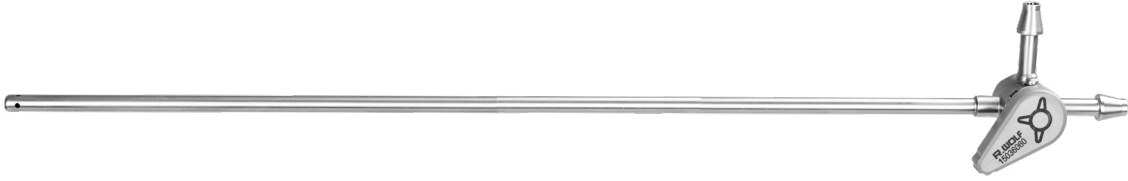





MULTIFUNCTIONAL SUCTION IRRIGATION SYSTEM

				
	<b>Suction tube graduated Ø 5 mm WL 330 mm</b>	<b>Outer Ø</b>	<b>WL</b>	<b>Product no.</b>
graduated, with 3 mm Luer connector		5.0 mm	330 mm	<b>8383.68</b>
				
	<b>Suction irrigation tube Ø 5 mm WL 300 mm</b>	<b>Outer Ø</b>	<b>WL</b>	<b>Product no.</b>
with stop valve		5.0 mm	300 mm	<b>8383.94</b>
				
	<b>Suction irrigation tube WL 290 mm</b>	<b>Outer Ø</b>	<b>WL</b>	<b>Product no.</b>
with maintenance-free two-way stopcock, sheath tube, with distal openings, reusable	<b>Suction irrigation tube WL 410 mm</b>	5.0 mm	290 mm	<b>8583732</b>
		5.0 mm	410 mm	<b>8584732</b>

III23 || Subject to modifications. Please note that some products may not be available in all countries. Please always take note of the information that is provided with the product. For more detailed information, please consult with your contact partner or directly with Richard Wolf GmbH.

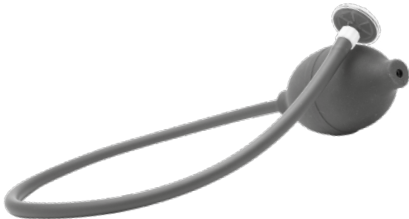

## ACCESSORIES / DISPOSABLE HAND BLOWER FOR SUCTION AND IRRIGATION

				
<b>Outer Ø</b> <b>WL</b> <b>Product no.</b>				
	<b>Suction irrigation tube Ø 3 mm WL 300 mm</b>	3.0 mm	330 mm	<b>8383.72</b>
with Luer connector				
				
<b>Outer Ø</b> <b>WL</b> <b>Product no.</b>				
	<b>HF coagulation suction device mono Ø 5 mm WL 315 mm</b>	5.0 mm	315 mm	<b>8383.71</b>
with Luer connector and a valve	<b>HF coagulation suction device mono Ø 5 mm WL 350 mm</b>	5.0 mm	450 mm	<b>8384.71</b>
				
<b>for air insufflation</b> <b>Ø</b> <b>TL</b> <b>Product no.</b>				
	<b>Hand blower with disposable filter, sterile (PACK= 5 PCS)</b>	49 mm	567 mm	<b>412700</b>

HF connection cable: see sheet BDE116/117

# TISSUE RETRACTOR 5 MM





		Outer Ø	WL	Product no.
	tissue retractor Ø 5 mm WL 320 mm	5.0 mm	320 mm	<b>8383.691</b>

Accessories	Product no.
Luer sealing cap	<b>887.00</b>

III23 || Subject to modifications. Please note that some products may not be available in all countries. Please always take note of the information that is provided with the product. For more detailed information, please consult with your contact partner or directly with Richard Wolf GmbH.

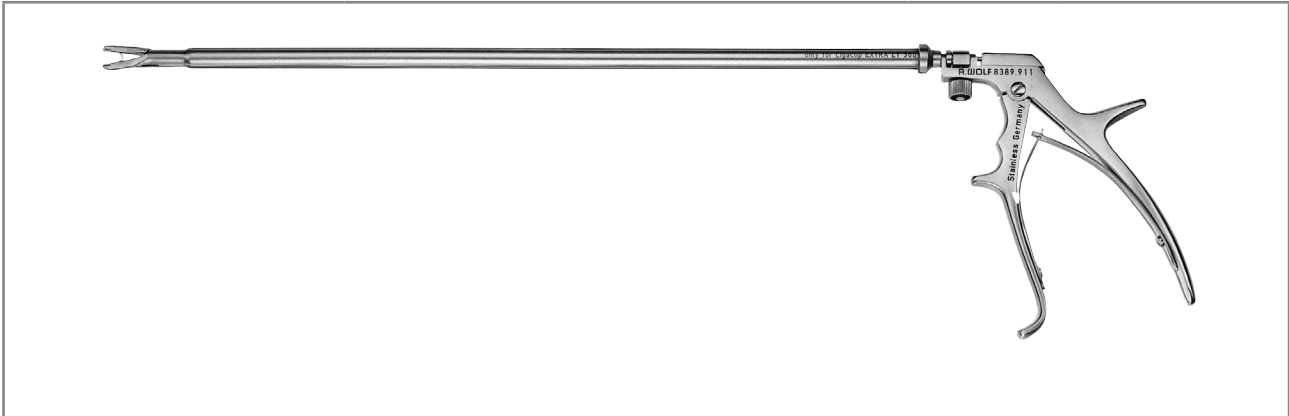
# CLIP APPLICATOR 10 MM FOR SUCTION AND IRRIGATION



		Outer Ø	WL	Product no.
	<b>Clip applicator Ø 10 mm WL 340 mm</b>	10 mm	340 mm	<b>8389.911</b>
<b>for this:</b>				<b>Product no.</b>
	<b>Introduction sleeve 10 mm WL 80 mm with sealing cap</b>			<b>8389.991</b>
For clip ligation with Ethicon® Ligaclip® EXTRA LT 300				
<b>Ethicon® Ligaclips® (PACK= 108 PCS)</b>				<b>8389.915</b>

Accessories	Product no.
Sealing cap capacity 9.5–10.1 mm	<b>89.08</b>

CLIP APPLICATOR

10

11123 || Subject to modifications. Please note that some products may not be available in all countries. Please always take note of the information that is provided with the product. For more detailed information, please consult with your contact partner or directly with Richard Wolf GmbH.

# ERAGON<sup>stitch</sup>

## THE ERGONOMIC GENERATION OF NEEDLE HOLDERS

Thanks to the custom combination options it offers, **ERAGON<sup>stitch</sup>** can accommodate any user requirement. The way in which it brings together ergonomics, versatility, modularity, and precision sets new standards in comfort

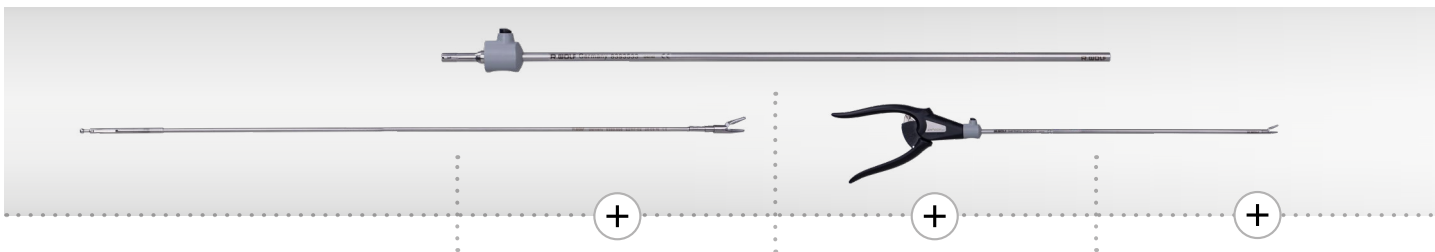

Choose working length

Choose jaw insert

Choose sheath tube

Choose handle





<p>∅ 5.0 mm</p>	<p>330 mm 450 mm</p>			
<p>∅ 3.5 mm</p>	<p>240 mm 330 mm</p>			

**ERAGONstitch needle holders**



**ERAGON<sup>stitch</sup>**  
NEEDLE HOLDER Ø 3.5 MM









Needle holder jaw insert			Sheath tube, Ø 3.5 mm		Needle holder handle		Complete instrument • Jaw insert • Sheath tube • Handle  <b>Product no.</b>	
					 			<ul style="list-style-type: none"> <li>with on-off detent mechanism, single-action</li> </ul>
					Axial	Angled		
	JL*	<b>Product no.</b>	8390533	8391533	8393943	8393944	<b>Product no.</b>	
	12 mm	8391505	•		•		<b>83915053</b>	
			•		•		<b>83915054</b>	
straight with carbide insert single-action		8391506		•	•		<b>83915063</b>	
				•		•	<b>83915064</b>	

\* JL = jaw length when jaw section closed (approximate measurements)

Accessories for manual and machine reprocessing	Product no.
 <b>Irrigation adapter cleaning</b> Ø 9 mm, length 64 mm for uninsulated sheath tubes	<b>163503</b>

1123 || Subject to modifications. Please note that some products may not be available in all countries. Please always take note of the information that is provided with the product. For more detailed information, please consult with your contact partner or directly with Richard Wolf GmbH.





**ERAGON** *stitch*  
NEEDLE HOLDER Ø 5.0 MM

Needle holder jaw insert			Sheath tube, Ø 5.0 mm		Needle holder handle		Complete instrument • Jaw insert • Sheath tube • Handle	
								
	JL*	Product no.	8393533	8394533	8393943	8393944	Product no.	
	19 mm	8393507	•		•		83935073	
			•			•	83935074	
straight with carbide insert single-action	19 mm	8394507		•	•		83945073	
				•		•	83945074	
	19 mm	8393508	•		•		83935083	
			•			•	83935084	
straight and narrow with carbide insert single-action	19 mm	8394508		•	•		83945083	
				•		•	83945084	
	19 mm	8393509	•		•		83935093	
			•			•	83935094	
straight, with self-righting function single-action	19 mm	8394509		•	•		83945093	
				•		•	83945094	

\* JL = jaw length when jaw section closed (approximate measurements)

Accessories for manual and machine reprocessing	Product no.
	<b>Irrigation adapter cleaning</b> Ø 9 mm, length 64 mm for uninsulated sheath tubes  <b>163503</b>

**ERAGON** *stitch*  
NEEDLE HOLDER Ø 5.0 MM

Needle holder jaw insert			Sheath tube, Ø 5.0 mm		Needle holder handle		Complete instrument • Jaw insert • Sheath tube • Handle	
								
			SL 330 mm	SL 450 mm	with on-off detent mechanism, single-action			
					Axial	Angled		
	JL*	Product no.	8393533	8394533	8393943	8393944	Product no.	
 Needle holder Ø 5 mm bndl  19 mm  curved right with carbide insert single-action		8393518	•		•		<b>83935183</b>	
			•			•	<b>83935184</b>	
		8394518		•		•		<b>83945183</b>
				•			•	<b>83945184</b>
 Needle holder Ø 5 mm bndl  19 mm  Curved left with carbide insert single-action		8393519	•		•		<b>83935193</b>	
			•			•	<b>83935194</b>	
		8394519		•		•		<b>83945193</b>
				•			•	<b>83945194</b>

Accessories for manual and machine reprocessing	Product no.
 Irrigation adapter cleaning Ø 9 mm, length 64 mm for uninsulated sheath tubes	<b>163503</b>

III23 || Subject to modifications. Please note that some products may not be available in all countries. Please always take note of the information that is provided with the product. For more detailed information, please consult with your contact partner or directly with Richard Wolf GmbH.

ERAGONSTITCH NEEDLE HOLDER











11

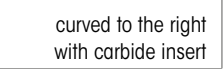

# NEEDLE HOLDER Ø 3.5 MM/5 MM

## MODULAR SYSTEM

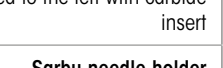

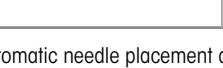

Needle holder jaw insert with sheath				Needle holder handle, axial		Complete instrument • Jaw insert • Sheath tube • Handle
						
	Product no.	Ø	SL	8393.941	Product no.	
 with carbide insert	8391504	3.5 mm	340 mm	•		<b>8391.501</b>
 for straight needles	8393504	5 mm	340 mm	•		<b>8393.501</b>
 with carbide insert	8393505	5 mm	340 mm	•		<b>8393.502</b>
 with carbide insert	8394505	5 mm	430 mm	•		<b>8394.502</b>
 curved to the right with carbide insert	8393514	5 mm	340 mm	•		<b>8393.511</b>
 curved to the right with carbide insert	8394514	5 mm	430 mm	•		<b>8394.511</b>
 curved to the left with carbide insert	8393515	5 mm	340 mm	•		<b>8393.512</b>
 curved to the left with carbide insert	8394515	5 mm	430 mm	•		<b>8394.512</b>
 Sarbu needle holder Ø 5 mm bndl	8393506	5 mm	340 mm	•		<b>8393.503*</b>
 Sarbu needle holder Ø 5 mm bndl	8394506	5 mm	430 mm	•		<b>8394.503*</b>

\* with automatic needle placement apparatus and cutting edge

# NEEDLE HOLDER HANDLE







Needle holder handle, axial	not rotatable	with lock	without HF	Product no.
	•	•	•	<b>8393.941</b>



Needle holder handle <small>ERAGON</small> <small>stitch</small>	axial	angled	with on-off detent mechanism	single-action	Not rotatable	Product no.
	•		•	•	•	<b>8393943</b>
		•	•	•	•	<b>8393944</b>

III23 || Subject to modifications. Please note that some products may not be available in all countries. Please always take note of the information that is provided with the product. For more detailed information, please consult with your contact partner or directly with Richard Wolf GmbH.

**ERAGON**<sub>modular</sub>

**MODULAR KNOT PUSHER Ø 5.0 MM, INSULATED**

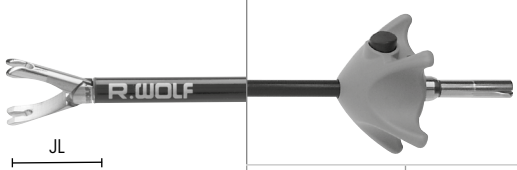
		Handle, axial			
 All jaw inserts and sheath tubes can also be combined with <b>ERAGONaxial</b>					
		with lock	without lock, with HF connector	without lock, with HF connector	with lock, not rotatable
<b>Rotatable knob</b>	<b>Product no.</b>	83930082	83930083	83930084	83930085
	8988	•	•	•	•

Jaw insert		Sheath tube, Ø 5.0 mm, insulated		Handle	Complete instrument • Jaw insert with sheath tube • Handle	
  JL		SL 330 mm	SL 450 mm	 with lock, without HF		
	JL*	<b>Product no.</b>	8393933	8394933	83930072	<b>Product no.</b>
<b>Knot pusher Ø 5 mm bndl</b>	17 mm	8393.345	•		•	<b>83933457</b>
with distal recess, double-action		8394345		•	•	<b>83943457</b>

KNOT PUSHER

11



\* JL = jaw length when jaw section closed (approximate measurements)

HF connection cable: see sheet BDE116/117

1123 || Subject to modifications. Please note that some products may not be available in all countries. Please always take note of the information that is provided with the product. For more detailed information, please consult with your contact partner or directly with Richard Wolf GmbH.

# KNOT PUSHER 5 MM FOR ENDOSCOPIC SUTURING



		Outer Ø	WL	TL	Product no.
	<b>Knot pusher Ø 3.7 mm WL 330 mm</b>	3.7 mm	330 mm	380 mm	<b>8383.55</b>
for intraabdominal knots					
	<b>Knot pusher Ø 3.7 mm WL 330 mm</b>	3.7 mm	330 mm	380 mm	<b>8383.551</b>
for extracorporeal knots					





		Outer Ø	WL	TL	Product no.
	<b>Knot pusher Ø 5 mm WL 330 mm</b> as per Bueß	5.0 mm	330 mm	380 mm	<b>8383.552</b>
with distal notch and lateral opening for optimum knotting, extremely atraumatic tip for use as a surgical probe					

|||23 || Subject to modifications. Please note that some products may not be available in all countries. Please always take note of the information that is provided with the product. For more detailed information, please consult with your contact partner or directly with Richard Wolf GmbH.







# Endoscopically controlled fascia closure system AS PER BUSCHE



				Product no.
 for subcutaneous fascia suture	Sealing cone Ø 10–12 mm			8934.915
	Sealing cone Ø 12–15 mm			8943.915
	Sealing cone Ø 15–20 mm			8945.915
		Ø	WL	Product no.
 Needle forceps with active suture holder	Needle forceps Ø 2.45 mm WL 160 mm	2.45 mm	160 mm	8756.201

11123 || Subject to modifications. Please note that some products may not be available in all countries. Please always take note of the information that is provided with the product. For more detailed information, please consult with your contact partner or directly with Richard Wolf GmbH.

## CANNULAS 3.0 MM/4.7 MM

				
<b>with Luer connector</b>		<b>Outer Ø</b>	<b>WL</b>	<b>Product no.</b>
 Tip Ø 1.4 mm	<b>Injection cannula Ø 3 mm WL 340 mm</b>	3.0 mm	340 mm	<b>8379.732</b>
				
<b>with 3 mm Luer connector</b>		<b>Ø</b>	<b>WL</b>	<b>Product no.</b>
 Tip Ø 1.8 mm	<b>Injection cannula Ø 4.7 mm WL 350 mm</b>	4.7 mm	350 mm	<b>8383.65</b>
				
<b>with suction regulator and 4 mm Luer connector</b>		<b>Ø</b>	<b>WL</b>	<b>Product no.</b>
 Tip Ø 1.8 mm	<b>Puncture cannula Ø 4.7 mm WL 320 mm</b>	4.7 mm	320 mm	<b>8383.49</b>
<b>for this:</b>		<b>WL</b>	<b>Product no.</b>	
	<b>Introduction sleeve size 5.5 mm WL 45 mm</b>  This sleeve prevents damage to the cannula tip when the trocar sleeve valve is opened	45 mm	<b>8383.00</b>	

# SURGICAL PROBES



		Ø	WL	Product no.
	<b>Surgical probe 3.5 mm WL 350 mm graduated</b>	3.5 mm	350 mm	<b>8379.672</b>



		Ø	WL	Product no.
	<b>Surgical probe Ø 5 mm WL 328 mm graduated</b>	5.0 mm	328 mm	<b>8383.66</b>
	<b>Surgical probe Ø 5 mm WL 448 mm graduated</b>	5.0 mm	448 mm	<b>8384.66</b>

11123 || Subject to modifications. Please note that some products may not be available in all countries. Please always take note of the information that is provided with the product. For more detailed information, please consult with your contact partner or directly with Richard Wolf GmbH.

# MYOMA DRILL 5 MM/10 MM



		Ø	WL	Product no.
	Myoma drill Ø 5 mm WL 320 mm	5 mm	320 mm	<b>8383.611</b>
	Myoma drill Ø 10 mm	10 mm	340 mm	<b>8385.301</b>

III23 || Subject to modifications. Please note that some products may not be available in all countries. Please always take note of the information that is provided with the product. For more detailed information, please consult with your contact partner or directly with Richard Wolf GmbH.



# INSUFFLATOR HIGHFLOW 45 BASIC



		Product no.
<b>Insufflator 45 BASIC bndI</b> consisting of: Insufflator 45 BASIC FR 45 l/min (2235001), Insufflation tube set L 2.5 m (8170.101), Hygiene filter, sterile, disposable (PACK= 10 PCS) (4171.111) and power cable 3 m long (2440.03)		<b>22350011</b>
<b>Accessories: Tube sets for insufflation</b>		
Insufflation tube set L 2.5 m, High Flow, D = 8 mm, autoclavable		<b>8170.232</b>
Insufflation tube set L 2.5 m, autoclavable		<b>8170.101</b>
Insufflation tube set L 2.7 m, with integrated hygiene filter, disposable, (PACK= 10 PCS) in individual sterile packaging		<b>4170.501</b>
Hygiene filter, sterile, disposable (PACK= 10 PCS) in individual sterile packaging		<b>4171.111</b>
<b>Accessories for gas supply</b>		
CO <sub>2</sub> connection tube 1.5 m NIST-NIST		<b>74021038</b>
with		
Pressure reducer for CO <sub>2</sub> connector DIN 477-1	DIN 477-1	<b>74007054</b>
Pressure reducer for CO <sub>2</sub> connector DIN EN ISO 407	DIN EN ISO 407	<b>74007055</b>
Pressure reducer for CO <sub>2</sub> connector ISO 5145	ISO 5145	<b>74007056</b>
or		
Connection tube for CO <sub>2</sub> 5.0 m DIN for centralized CO <sub>2</sub> gas supply (Dräger)		<b>74021039</b>
Connection tube for CO <sub>2</sub> 5.0 m NF for centralized CO <sub>2</sub> gas supply (Liquid Air)		<b>74021040</b>
<b>Software modules (optional)</b>		
Software module CAN bus CAN bus interface for integration in CORE		<b>2235101</b>
Software module BABY MODE BABY MODE for special use in pediatrics		<b>2235102</b>
Software module VIDEO DISPLAY: video display using DIALOG via CAN bus		<b>2235103</b>

# TECHNICAL DATA

## INSUFFLATOR HIGHFLOW 45 BASIC

Insufflator 45 BASIC		2235001
<b>Device properties</b>		
Operating mode	Continuous operation	
Operating conditions	+10°C to +40°C, 30% to 75% rel. humidity, atmospheric pressure 700 hPa to 1,060 hPa	
Storage and transport conditions	-20°C to +60°C, 10% to 90% rel. humidity, atmospheric pressure 700 hPa to 1,060 hPa	
<b>Power supply</b>		
Mains + frequency	100–240 V~, 50/60 Hz	
Power consumption	60 VA	
Current rating	0.6–0.2 A	
Fuse	T 3.15 AH 250 V	
<b>Regulatory standards</b>		
Protection class to IEC/EN 60601-1 (UL 60601-1/CSA C222 No6011 – for USA)	I	
Electromagnetic compatibility (EMC)	IEC/EN 60601-1-2	
Medical Devices Directive 93/42/EEC	Class IIb	
Protection against electric shock	Type CF applied part	
Degree of protection against the ingress of liquids	IP 20 (not protected)	
Degree of protection in the presence of flammable mixtures	Device is not protected against explosions (do not operate this device in explosive atmospheres)	
<b>Dimensions and weights</b>		
Weight	8.9 kg (19.5 lbs)	
Dimensions (W x H x D)	300 mm x 160 mm x 455 mm	

Relevant application parameters	
Insufflation medium	Medical-grade CO <sub>2</sub> (degree of purity > 99.5%)
Intraabdominal pressure	3 mmHg to 25 mmHg (± 2 mmHg) selectable in increments of 1 mmHg
Gas flow rate primary filling	1 l/min (± 50%)
Gas flow rate, High Flow	2 l/min to 45 l/min (± 20%) selectable in increments of 1 l/min
Consumption indicator	0 l to 9,999 l (± 20%)

# INSUFFLATOR HIGHFLOW 45 EVAC WITH SMOKE GAS EVACUATION



		Product no.
<b>Insufflator 45 EVAC bndl</b> consisting of: Insufflator 45 EVAC FR 45 l/min (2235011), Insufflation tube set L 2.5 m (8170.101), Hygiene filter, sterile, disposable (PACK= 10 PCS) (4171.111), Insufflation tube set L 2.7 m with integrated hygiene filter, sterile, disposable (PACK= 10 PCS) (4170.501) Smoke gas evacuation tube set L 2.7 m, sterile, disposable (PACK= 10 PCS) (4170503) Footswitch with 1 pedal (20301031) and power cable, 3 m long (2440.03)		<b>22350111</b>
<b>Accessories: Tube sets for insufflation</b>		
Smoke gas evacuation tube set L 2.7 m, sterile, disposable (PACK= 10 PCS)		<b>4170503</b>
<b>Accessories for gas supply</b>		
CO <sub>2</sub> connection tube 1.5 m NIST-NIST		<b>74021038</b>
with		
Pressure reducer for CO <sub>2</sub> connector DIN 477-1	DIN 477-1	<b>74007054</b>
Pressure reducer for CO <sub>2</sub> connector DIN EN ISO 407	DIN EN ISO 407	<b>74007055</b>
Pressure reducer for CO <sub>2</sub> connector ISO 5145	ISO 5145	<b>74007056</b>
or		
Connection tube for CO <sub>2</sub> 5.0 m DIN for centralized CO <sub>2</sub> gas supply (Dräger)		<b>74021039</b>
Connection tube for CO <sub>2</sub> 5.0 m NF for centralized CO <sub>2</sub> gas supply (Liquid Air)		<b>74021040</b>
<b>Software modules (optional)</b>		
Software module CAN bus CAN bus interface for integration in CORE		<b>2235101</b>
Software module BABY MODE BABY MODE for special use in pediatrics		<b>2235102</b>
Software module VIDEO DISPLAY: video display using DIALOG via CAN bus		<b>2235103</b>

# TECHNICAL DATA

## INSUFFLATOR HIGHFLOW 45 EVAC

Insufflator 45 EVAC		2235011
<b>Device properties</b>		
Operating mode	Continuous operation	
Operating conditions	+10°C to +40°C, 30% to 75% rel. humidity, atmospheric pressure 700 hPa to 1,060 hPa	
Storage and transport conditions	-20°C to +60°C, 10% to 90% rel. humidity, atmospheric pressure 700 hPa to 1,060 hPa	
<b>Power supply</b>		
Mains + frequency	100–240 V~, 50/60 Hz	
Power consumption	60 VA	
Current rating	0.6–0.2 A	
Fuse	T 3.15 AH 250 V	
<b>Regulatory standards</b>		
Protection class to IEC/EN 60601-1 (UL 60601-1/CSA C222 No6011 – for USA)	I	
Electromagnetic compatibility (EMC)	IEC/EN 60601-1-2	
Medical Devices Directive 93/42/EEC	Class IIb	
Protection against electric shock	Type CF applied part	
Degree of protection against the ingress of liquids	IP 20 (not protected)	
Degree of protection in the presence of flammable mixtures	Device is not protected against explosions (do not operate this device in explosive atmospheres)	
<b>Dimensions and weights</b>		
Weight	8.9 kg (19.5 lbs)	
Dimensions (W x H x D)	300 mm x 160 mm x 455 mm	

Relevant application parameters	
Insufflation medium	Medical-grade CO <sub>2</sub> (degree of purity > 99.5%)
Intraabdominal pressure	3 mmHg to 25 mmHg (± 2 mmHg) selectable in increments of 1 mmHg
Gas flow rate primary filling	1 l/min (± 50%)
Gas flow rate, High Flow	2 l/min to 45 l/min (± 20%) selectable in increments of 1 l/min
Consumption indicator	0 l to 9,999 l (± 20%)

# INSUFFLATOR HIGHFLOW 45 HEAT WITH GAS HEATING



		Product no.
<b>Insufflator 45 HEAT bndI</b> consisting of: Insufflator 45 HEAT FR 45 L/min(2235021), Insufflation tube for 2235021/031 L 3 m (8170202) Hygiene filter, sterile, disposable (PACK= 10 PCS) (4171.111) and power cable 3 m long (2440.03)		<b>22350211</b>
<b>Accessories: Tube sets for insufflation</b>		
<b>Insufflation tube set L 3 m</b> Highflow, with heating wire and integrated hygiene filter, sterile, disposable, (PACK= 10 PCS) in individual sterile packaging		<b>4170502</b>
<b>Insufflation tube for 2235021/031 L 3 m</b> Highflow, with heating wire, autoclavable, 3.0 m The reusable tube can be used up to 100 times		<b>8170202</b>
<b>Hygiene filter</b> , sterile, disposable (PACK= 10 PCS) in individual sterile packaging		<b>4171.111</b>
<b>Accessories for gas supply</b>		
<b>CO<sub>2</sub> connection tube 1.5 m NIST-NIST</b>		<b>74021038</b>
with		
<b>Pressure reducer for CO<sub>2</sub> connector DIN 477-1</b>	DIN 477-1	<b>74007054</b>
<b>Pressure reducer for CO<sub>2</sub> connector DIN EN ISO 407</b>	DIN EN ISO 407	<b>74007055</b>
<b>Pressure reducer for CO<sub>2</sub> connector ISO 5145</b>	ISO 5145	<b>74007056</b>
or		
<b>Connection tube for CO<sub>2</sub> 5.0 m DIN</b> for centralized CO <sub>2</sub> gas supply (Dräger)		<b>74021039</b>
<b>Connection tube for CO<sub>2</sub> 5.0 m NF</b> for centralized CO <sub>2</sub> gas supply (Liquid Air)		<b>74021040</b>
<b>Software modules (optional)</b>		
<b>Software module CAN bus</b> CAN bus interface for integration in CORE		<b>2235101</b>
<b>Software module BABY MODE</b> BABY MODE for special use in pediatrics		<b>2235102</b>
<b>Software module VIDEO DISPLAY:</b> video display using DIALOG via CAN bus		<b>2235103</b>

# TECHNICAL DATA

## INSUFFLATOR HIGHFLOW 45 HEAT

Insufflator 45 HEAT		2235021
<b>Device properties</b>		
Operating mode	Continuous operation	
Operating conditions	+10°C to +40°C, 30% to 75% rel. humidity, atmospheric pressure 700 hPa to 1,060 hPa	
Storage and transport conditions	-20°C to +60°C, 10% to 90% rel. humidity, atmospheric pressure 700 hPa to 1,060 hPa	
<b>Power supply</b>		
Mains + frequency	100–127/220–240 V~, 50/60 Hz	
Power consumption	80 VA	
Current rating	0.8–0.3 A	
Fuse	T 3.15 AH 250 V	
<b>Regulatory standards</b>		
Protection class to IEC/EN 60601-1 (UL 60601-1/CSA C222 No6011 – for USA)	I	
Electromagnetic compatibility (EMC)	IEC/EN 60601-1-2	
Medical Devices Directive 93/42/EEC	Class IIb	
Protection against electric shock	Type CF applied part	
Degree of protection against the ingress of liquids	IP 20 (not protected)	
Degree of protection in the presence of flammable mixtures	Device is not protected against explosions (do not operate this device in explosive atmospheres)	
<b>Dimensions and weights</b>		
Weight	11.0 kg (23.3 lbs)	
Dimensions (W x H x D)	300 mm x 160 mm x 455 mm	
<b>Relevant application parameters</b>		
Insufflation medium	Medical-grade CO <sub>2</sub> (degree of purity > 99.5%)	
Intraabdominal pressure	3 mmHg to 25 mmHg (± 2 mmHg) selectable in increments of 1 mmHg	
Gas flow rate primary filling	1 l/min (± 50%)	
Gas flow rate, High Flow	2 l/min to 45 l/min (± 20%) selectable in increments of 1 l/min	
Consumption indicator	0 l to 9,999 l (± 20%)	

# INSUFFLATOR HIGHFLOW 45 EVAC + HEAT

## WITH SMOKE GAS EVACUATION AND GAS HEATING



		Product no.
<b>Insufflator 45 EVAC + HEAT bndl</b>		<b>22350311</b>
consisting of: Insufflator 45 EVAC + HEAT FR 45 l/min(2235031),		
Insufflation tube for 2235021/031 L 3 m (8170202),		
Insufflation tube set L 3 m, sterile, disposable, (PACK= 10 PCS) (4170502),		
Hygiene filter, sterile, disposable (PACK= 10 PCS) (4171.111),		
Smoke gas evacuation tube set L 2.7 m, sterile, disposable (PACK= 10 PCS) (4170503)		
Footswitch 1 pedal (20301031) and power cable 3 m long (2440.03)		
<b>Accessories: Tube sets for insufflation</b>		
<b>Insufflation tube set L 3 m</b> Highflow, with heating wire and integrated hygiene filter, sterile, disposable, (PACK= 10 PCS) in individual sterile packaging		<b>4170502</b>
<b>Insufflation tube for 2235021/031 L 3 m</b> Highflow, with heating wire, autoclavable, 3.0 m The reusable tube can be used up to 100 times		<b>8170202</b>
<b>Hygiene filter</b> , sterile, disposable (PACK= 10 PCS) in individual sterile packaging		<b>4171.111</b>
<b>Smoke gas evacuation tube set L 2.7 m</b> , sterile, disposable (PACK= 10 PCS)		<b>4170503</b>
<b>Accessories for gas supply</b>		
<b>CO<sub>2</sub> connection tube 1.5 m NIST-NIST</b>		<b>74021038</b>
with		
<b>Pressure reducer for CO<sub>2</sub> connector DIN 477-1</b>	DIN 477-1	<b>74007054</b>
<b>Pressure reducer for CO<sub>2</sub> connector DIN EN ISO 407</b>	DIN EN ISO 407	<b>74007055</b>
<b>Pressure reducer for CO<sub>2</sub> connector ISO 5145</b>	ISO 5145	<b>74007056</b>
or		
<b>Connection tube for CO<sub>2</sub> 5.0 m DIN</b> for centralized CO <sub>2</sub> gas supply (Dräger)		<b>74021039</b>
<b>Connection tube for CO<sub>2</sub> 5.0 m NF</b> for centralized CO <sub>2</sub> gas supply (Liquid Air)		<b>74021040</b>
<b>Software modules (optional)</b>		
<b>Software module CAN bus</b> CAN bus interface for integration in CORE		<b>2235101</b>
<b>Software module BABY MODE</b> BABY MODE for special use in pediatrics		<b>2235102</b>
<b>Software module VIDEO DISPLAY:</b> video display using DIALOG via CAN bus		<b>2235103</b>

# TECHNICAL DATA

## INSUFFLATOR HIGHFLOW 45 EVAC + HEAT

Insufflator 45 EVAC + HEAT		2235031
<b>Device properties</b>		
Operating mode	Continuous operation	
Operating conditions	+10°C to +40°C, 30% to 75% rel. humidity, atmospheric pressure 700 hPa to 1,060 hPa	
Storage and transport conditions	-20°C to +60°C, 10% to 90% rel. humidity, atmospheric pressure 700 hPa to 1,060 hPa	
<b>Power supply</b>		
Mains + frequency	100–127/220–240 V~, 50/60 Hz	
Power consumption	80 VA	
Current rating	0.8–0.3 A	
Fuse	T 3.15 AH 250 V	
<b>Regulatory standards</b>		
Protection class to IEC/EN 60601-1 (UL 60601-1/CSA C222 No6011 – for USA)	I	
Electromagnetic compatibility (EMC)	IEC/EN 60601-1-2	
Medical Devices Directive 93/42/EEC	Class IIb	
Protection against electric shock	Type CF applied part	
Degree of protection against the ingress of liquids	IP 20 (not protected)	
Degree of protection in the presence of flammable mixtures	Device is not protected against explosions (do not operate this device in explosive atmospheres)	
<b>Dimensions and weights</b>		
Weight	11.0 kg (23.3 lbs)	
Dimensions (W x H x D)	300 x 160 x 455 mm	

Relevant application parameters	
Insufflation medium	Medical-grade CO <sub>2</sub> (degree of purity > 99.5%)
Intraabdominal pressure	3 mmHg to 25 mmHg (± 2 mmHg) selectable in increments of 1 mmHg
Gas flow rate primary filling	1 l/min (± 50%)
Gas flow rate, High Flow	2 l/min to 45 l/min (± 20%) selectable in increments of 1 l/min
Consumption indicator	0 l to 9,999 l (± 20%)



# LAPARO-CO<sub>2</sub>-PNEU 2233



		Product no.
<b>LAPARO-CO<sub>2</sub>-PNEU bndl</b> consisting of: LAPARO-CO2-PNEU 2233 FR 20 L/MIN (2233.001) Insufflation tube set L 2.5 m (8170.101), Hygiene filter, sterile, disposable (PACK= 10 PCS) (4171.111), and power cable 3 m long (2440.03)		<b>22330011</b>
<b>Accessories: Tube sets for insufflation</b>		
<b>Insufflation tube set, L 2.7 m</b> with integrated hygiene filter, sterile, disposable, (PACK= 10 PCS) in individual sterile packaging		<b>4170.501</b>
<b>Accessories for gas supply</b>		
<b>CO<sub>2</sub> connection tube 1.5 m NIST-NIST</b>		<b>74021038</b>
with		
<b>Pressure reducer for CO<sub>2</sub> connector DIN 477-1</b>	DIN 477-1	<b>74007054</b>
<b>Pressure reducer for CO<sub>2</sub> connector DIN EN ISO 407</b>	DIN EN ISO 407	<b>74007055</b>
<b>Pressure reducer for CO<sub>2</sub> connector ISO 5145</b>	ISO 5145	<b>74007056</b>
or		
<b>Connection tube for CO<sub>2</sub> 5.0 m DIN for centralized CO<sub>2</sub> gas supply (Dräger)</b>		<b>74021039</b>
<b>Connection tube for CO<sub>2</sub> 5.0 m NF for centralized CO<sub>2</sub> gas supply (Liquid Air)</b>		<b>74021040</b>



# TECHNICAL DATA

## LAPARO-CO<sub>2</sub>-PNEU 2233

LAPARO-CO <sub>2</sub> -PNEU 2233		2233.001
<b>Device properties</b>		
Operating mode	Continuous operation	
Operating conditions	+10°C to +40°C, 30% to 75% rel. humidity, atmospheric pressure 700 hPa to 1,060 hPa	
Storage and transport conditions	-20°C to +60°C, 10% to 90% rel. humidity, atmospheric pressure 700 hPa to 1,060 hPa	
<b>Power supply</b>		
Mains + frequency	100–230 V~, 50/60 Hz	
Power consumption	80 VA	
Current rating	0.8 A	
Fuse	T 2 AL 250 V	
<b>Regulatory standards</b>		
Protection class to IEC/EN 60601-1 (UL 60601-1/CSA C222 No6011 – for USA)	I	
Electromagnetic compatibility (EMC)	EN/IEC 60601--1--2	
Medical Devices Directive 93/42/EEC	Class IIb	
Protection against electric shock	Type CF applied part	
Degree of protection against the ingress of liquids	IP 20 (not protected)	
Degree of protection in the presence of flammable mixtures	Device is not protected against explosions (do not operate this device in explosive atmospheres)	
Maximum suction vacuum	-60 kPa	
<b>Dimensions and weights</b>		
Weight	9.5 kg	
Dimensions (W x H x D)	330 mm x 155 mm x 390 mm	

Relevant application parameters	
Insufflation medium	Medical-grade CO <sub>2</sub> (degree of purity > 99.5%)
Intraabdominal pressure	3 mmHg to 25 mmHg (± 2 mmHg) selectable in increments of 1 mmHg
Gas flow rate primary filling	1 l/min (± 50%)
Gas flow rate, High Flow	2 l/min to 20 l/min (± 20%) selectable in increments of 1 l/min
Consumption indicator	0 l to 9,999 l (± 20%)

**STERILE SMOKE**  
FOR SMOKE GAS DISCHARGE

 	
<b>Product no.</b>	
<p><b>Smoke set</b> smoke filter with tube (PACK= 10 PCS) in individual sterile packaging</p>	<p><b>2200/47BDKBTUA123</b></p>

III23 || Subject to modifications. Please note that some products may not be available in all countries. Please always take note of the information that is provided with the product. For more detailed information, please consult with your contact partner or directly with Richard Wolf GmbH.

# FLUID CONTROL 2225

## SUCTION IRRIGATION PUMP



core

		Product no.
FLUID CONTROL 2225 <b>Irrigation pump for Hys/Uro/Lap bndl</b> consisting of: Irrigation pump for Hys/Uro/Lap (2225001) and power cable 3 m long (2440.03)		<b>22250011</b>
<b>for this:</b>		
<b>Balancing module</b> for hysteroscopy and endourology, fluid management for fluid balancing in combination with FLUID CONTROL 2225, mobile stand with integrated weighing cells and space for up to 4 irrigation fluid bags		<b>2225023</b>

Accessories		Product no.
<b>Footswitch</b>	only for use in urology and within the indication TUR/enucleation, possibility of short-term increase in pressure if visibility is poor (Flush function)	<b>2204901</b>

|||23 || Subject to modifications. Please note that some products may not be available in all countries. Please always take note of the information that is provided with the product. For more detailed information, please consult with your contact partner or directly with Richard Wolf GmbH.

# FLUID CONTROL 2225

## SUCTION IRRIGATION TUBE SETS

Irrigation			Product no.
<b>Accessories – reusable</b>	<b>Tube set with piercing spike</b>	with Luer-Lock connection, autoclavable, incl. 10 spare membranes, reusable for 20 reprocessing cycles	<b>8171223</b>
<b>Accessories – disposable</b>	<b>Irrigation tube set with piercing spike, L 3 m</b>	(PACK= 10 PCS), with Luer-Lock connection, sterile, disposable product	<b>4171223</b>
	<b>Tube set with CARE-LOCK, L 3 m</b>	(PACK= 10 PCS), sterile, disposable product	<b>4171224</b>
	<b>Suction irrigation tube set</b>	(PACK= 10 PCS), with piercing spike, sterile disposable product, PVC	<b>4171225</b>
	<b>Day irrigation tube set</b>	(PACK= 10 PCS), sterile, disposable product, PVC	<b>4171226</b>
	<b>Patient irrigation tube set, sterile</b>	(PACK= 10 PCS), with Luer-Lock connection, sterile, disposable product, PVC	<b>4171227</b>
<i>Note: Day tube and patient tube can only be used together. A new patient tube is required for each patient; the day tube can be used for up to 20 patients</i>			

Suction			Product no.
<b>Accessories – reusable</b>	<b>Tube set for vacuum, incl. filter</b>	with integrated hygiene filter, PACK= 10 PCS, service life: 30 days (connected to irrigation pump)	<b>2206207</b>
	<b>Irrigation tube</b>	L 1.2 m, with Luer-Lock, for suction irrigation handle 8385.901 and tube set 8171223 or 8170.223	<b>817123</b>
	<b>Suction tube L 3 m</b>	for suction irrigation handle 8385.901	<b>8171402</b>
	<b>Secretion container, 2 l</b>	2 liters, with lid	<b>8170.655</b>
	<b>Secretion container, 2 l</b>	2 liters, no lid	<b>8170.6551</b>
<b>Accessories – disposable</b>	<b>Secretion container, 2.5 l</b>	2.5 liters	<b>41706566</b>
	<b>Secretion container bndl consisting of:</b>	Secretion container 2.5 l (41706566) and secretion bag (PACK= 90 PCS) (41706564)	<b>4170657</b>
	<b>Tube set for suction (2 connections)</b>	sterile, disposable product, (PACK= 10 PCS) for connecting instruments to collecting container	<b>T0503-01</b>
	<b>Angled 90° plug-in coupling</b>	(PACK= 10 PCS) For connecting vacuum tube 2206207 to disposable container systems	<b>0771019</b>

# FLUID CONTROL 2225

## CABLE ACCESSORIES

		Product no.
Patch cable, RJ45 SFTP, 0.5 m	Cable length 0.5 m	<b>72325378</b>
Patch cable, RJ45 HRS TM11, 1.0 m	Cable length 1.0 m	<b>72325429</b>
Patch cable, RJ45 S/FTP CAT6 10 m	Cable length 10 m	<b>72325434</b>
Plastic caps for network socket	(PACK= 8 PCS)	<b>5592105</b>
Power cable	Cable length 3 m	<b>2440.03</b>

III23 || Subject to modifications. Please note that some products may not be available in all countries. Please always take note of the information that is provided with the product. For more detailed information, please consult with your contact partner or directly with Richard Wolf GmbH.

# TECHNICAL DATA

## FLUID CONTROL 2225

FLUID CONTROL 2225		2225001
<b>Device properties</b>		
Operating conditions		+10°C to +40°C, 30% to 75% rel. humidity, 70 to 106 kPa atmospheric pressure 3,000 m max. altitude above sea level
Storage and transport conditions		-20°C to +60°C, 10% to 90% rel. humidity 70 to 106 kPa atmospheric pressure
<b>Power supply</b>		
Mains + frequency		100–240 V~, 50/60 Hz
Power consumption	100 V/60 Hz	110 VA
	240 V/50 Hz	120 VA
Current rating	100 V/60 Hz	1.10 A
	240 V/50 Hz	0.50 A
Fuse		T 3.15 AH, 250 V
<b>Regulatory standards</b>		
Protection class (I, II)		I
Electromagnetic compatibility (EMC)		EN 60601-1/IEC 60601-1 EN 60601-1-2/IEC 60601-1-2
Medical Devices Directive 93/42/EEC		Class IIb
Housing protection rating (IP code)		IP21
Protection against electric shock		Type BF applied part
Degree of protection in the presence of flammable mixtures		Device is not protected against explosions (do not operate this device in explosive atmospheres)
Maximum suction vacuum		-60 kPa
<b>Dimensions and weights</b>		
Weight		8.8 kg
Dimensions (W x H x D)		300 mm x 157 mm x 436 mm
<b>Relevant application parameters</b>		
Nominal flow range		Hysteroscopy: 800 ml/min (max. flow, not adjustable) Endourology: 10–800 ml/min (max. flow) Laparoscopy: 0.1–1.8 l/min (max. flow)
Suction power		max. 2 l/min
Starting nominal pressure range		Hysteroscopy: 15–200 mmHg Endourology: 15–90 mmHg/20–120 cmH2O Laparoscopy: 300 mmHg (not adjustable)
Pressure		0–300 mmHg
Deficit		-9,990 to +9,990 ml/0 to 99.9 l

# TECHNICAL DATA

## FLUID CONTROL 2225

<b>Balancing module</b>		<b>2225023</b>
<b>Device properties</b>		
Operating conditions	+10°C to +40°C, 30% to 75% rel. humidity, 70 to 106 kPa atmospheric pressure 3,000 m max. altitude above sea level	
Storage and transport conditions	-20°C to +60°C , 10% to 90% rel. humidity 70 to 106 kPa atmospheric pressure	
<b>Regulatory standards</b>		
Electromagnetic compatibility (EMC)	EN 60601-1/IEC 60601-1 EN 60601-1-2/IEC 60601-1-2	
Housing protection rating (IP code)	IP21	
Maximum load of container scale	16 kg/4 containers of 3 l each	
Maximum load of bag scale	23 kg/4 bags of 5 l each	
<b>Dimensions and weights</b>		
Weight	15.4 kg	
Dimensions (W x H x D)	618 mm x 1,064 mm x 618 mm	

<b>Footswitch</b>		<b>2204901</b>
<b>Power supply</b>		
Power supply connection	max. 24 V	
Power consumption	max. 0.1 A	
<b>Regulatory standards</b>		
Electromagnetic compatibility (EMC)	EN 60601-1/IEC 60601-1	
Housing protection rating (IP code)	IPX8	
Plug	7-pin circular connector	
Cable length	4.5 m	
<b>Dimensions and weights</b>		
Weight	300 g	
Dimensions (W x H x D)	66 mm x 27 mm x 91 mm	



# FLUID CONTROL LAP 2216

	
<b>Product no.</b>	
<p>FLUID CONTROL <b>LAP suction irrigation pump bndl</b> consisting of: LAP suction irrigation pump (2216001) and power cable 3 m long (2440.03)</p>	<b>22160011</b>

Accessories		Product no.
<b>Bracket</b>	for fixing the suction container on the irrigator stand or MUT cart	<b>2215.992</b>
<b>Universal holder</b>	for FLUID CONTROL LAP on RIWomobil	<b>32114605</b>

# LAP SUCTION IRRIGATION PUMP 2216

## SUCTION IRRIGATION TUBE SETS

Irrigation			Product no.
Accessories – reusable	Tube set with piercing spike	with Luer-Lock connection, autoclavable, incl. 10 spare membranes, reusable for 20 reprocessing cycles	<b>8171223</b>
	Irrigation tube set with piercing spike, L 3 m	(PACK= 10 PCS), with Luer-Lock connection, sterile, disposable product	<b>4171223</b>
Accessories – disposable	Tube set with CARE-LOCK, L 3 m	(PACK= 10 PCS), sterile, disposable product	<b>4171224</b>
	Suction irrigation tube set	(PACK= 10 PCS), with piercing spike, sterile disposable product, PVC	<b>4171225</b>
	Day irrigation tube set	(PACK= 10 PCS), sterile, disposable product, PVC	<b>4171226</b>
	Patient irrigation tube set, sterile	(PACK= 10 PCS), with Luer-Lock connection, sterile, disposable product, PVC	<b>4171227</b>
<i>Note: Day tube and patient tube can only be used together. A new patient tube is required for each patient; the day tube can be used for up to 20 patients</i>			

Suction			Product no.
Accessories – reusable	Tube set for vacuum, incl. filter	with integrated hygiene filter, PACK= 10 PCS, service life: 30 days (connected to irrigation pump)	<b>2206207</b>
	Irrigation tube	L 1.2 m, with Luer-Lock, for suction irrigation handle 8385.901 and tube set 8171223 or 8170.223	<b>817123</b>
	Suction tube L 3 m	for suction irrigation handle 8385.901	<b>8171402</b>
	Secretion container, 2 l	2 liters, with lid	<b>8170.655</b>
	Secretion container, 2 l	2 liters, no lid	<b>8170.6551</b>
Accessories – disposable	Secretion container, 2.5 l	2.5 liters	<b>41706566</b>
	Secretion container bndl consisting of:	Secretion container 2.5 l (41706566) and secretion bag (PACK= 90 PCS) (41706564)	<b>4170657</b>
	Tube set for suction (2 connections)	sterile, disposable product, (PACK= 10 PCS) for connecting instruments to collecting container	<b>T0503-01</b>
	Angled 90° plug-in coupling	(PACK= 10 PCS) For connecting vacuum tube 2206207 to disposable container systems	<b>0771019</b>

# TECHNICAL DATA

## FLUID CONTROL LAP 2216

LAP suction irrigation pump		2216001
<b>Device properties</b>		
Operating conditions	+10°C to +40°C, 30% to 75% rel. humidity, atmospheric pressure 700 hPa to 1,060 hPa 3,000 m max. altitude above sea level	
Storage conditions	+5°C to +40°C, 5% to 90% rel. humidity, atmospheric pressure 700 hPa to 1,060 hPa	
Transport and shipping conditions	-20°C to +60°C, 5% to 90% rel. humidity, atmospheric pressure 700 hPa to 1,060 hPa	
<b>Power supply</b>		
Mains + frequency	100–240 V~, 50/60 Hz	
Power consumption	100 V/60 Hz	65 VA
	240 V/50 Hz	96 VA
Current rating	100 V/60 Hz	0.65 A
	240 V/50 Hz	0.42 A
Protection class	I	
Electromagnetic compatibility (EMC)	IEC 60601-1/EN 60601-1 IEC 60601-1-2/EN 60601-1-2	
Medical Devices Directive 93/42/EEC	Class IIa	
Protection against electric shock	Type BF applied part	
Degree of protection against the ingress of liquids	IP 41	
Degree of protection in the presence of flammable mixtures	Device is not protected against explosions (do not operate this device in explosive atmospheres)	
<b>Dimensions and weights</b>		
Weight	4 kg	
Dimensions (W x H x D) with toggle screw	140 mm x 210 mm x 295 mm	

Relevant application parameters	
Maximum delivery rate	Rinsing: 2.0 l/min (± 10%), suction: 2.0 l/min (+0.4/-0.1 l/min)
Maximum pump pressure	400 mmHg (± 50 mmHg)
Motor cut-out	500 mmHg after 5 s (± 25 mmHg)
Suction pressure	between -50 kPa and -60 kPa
Connections	Equipotential bonding, vacuum connection

# HF GENERATOR 2260



core

		Product no.
HF surgical generator 400 kHz	for the connection of monopolar and bipolar accessories, international version (BOWA, KLS Martin, Olympus, Karl Storz, Valleylab)	2260001
HF surgical generator 400 kHz	for the connection of monopolar and bipolar accessories, E version (Erbe)	2260002

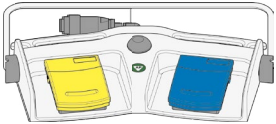
Accessories required	Cable length	Product no.
<b>Footswitch, 2 pedals L 5 m</b> with fixed connection cable, reusable 		2260021
<b>Neutral electrode</b> for use with high-frequency surgical device, Foil bag with 5 neutral electrodes, (PACK= 50 PCS)		1280H
<b>Mono HF neutral electrode cable, L 4.5 m</b>	4.5 m	2260031
<b>Power cable</b>	3.0 m	2440.03
<b>Bipo HF connection cable L 3 m</b>	3.0 m	8108233
<b>Bipo HF connection cable L 5 m</b>	5.0 m	8108253







III23 || Subject to modifications. Please note that some products may not be available in all countries. Please always take note of the information that is provided with the product. For more detailed information, please consult with your contact partner or directly with Richard Wolf GmbH.

# HF GENERATOR 2260

## TECHNICAL DATA

HF surgical generator 400kHz		2260001/2260002
<b>Device properties</b>		
Type of controls on housing front		Touch panel
Output power	max.cutting power	400 W
	max.coagulation power	350 W
LF and HF leakage currents		acc. to DIN EN 60601 1 and DIN EN 60601 2 2
Signal level		HF indicator 55 dB(A); adjustable 45–60 dB(A) Alarm 65 dB(A)
Operating conditions		+10°C to +40°C, 30% to 75% rel humidity, 700 hPa to 1,060 hPa atmospheric pressure
Storage and transport conditions		- 20°C to + 60°C, 10% to 90% rel humidity, 700 hPa to 1,060 hPa atmospheric pressure
<b>Power supply</b>		
Mains + frequency		100–240 V~, 50/60 Hz
Power consumption	without HF output	45 VA
	at max. output power	650 VA
Current rating		max. 6.3 A
Fuse		T 6.3 AH 250 V
<b>Regulatory standards</b>		
Protection class to EN/IEC 60601-1 (UL 2601-1/CSA C222 No6011 – for USA)		I
Electromagnetic compatibility (EMC)		EN/IEC 60601-1-2
Medical Devices Directive 93/42/EEC		Class IIb
Degree of protection against the ingress of liquids (DIN EN/IEC 60529)		IPX0
Degree of protection against the ingress of solids		IP2X
Duty factor (duty cycle DC)		Intermittent INT 10 s/30 s corresponding to 25% DC
Protection against electric shock		Model CF applied part, defibrillator-proof
Degree of protection in the presence of flammable mixtures		Device is not protected against explosions (do not operate this device in explosive atmospheres)
<b>Dimensions and weights</b>		
Weight		10.2 kg (22.4 lbs)
Dimensions (W x H x D)		300 x 159 x 419 mm

# HF CONNECTION CABLE MONO 815xxx





Instrument connector	Device connector		Product no.
<b>WOLF resectoscope</b> 	 Erbe (ACC/ICC/VIO)/BOWA (EU) R. Wolf HF surgical generator 400 kHz 2260002	HF connection cable mono L 3 m	<b>815.032</b>
		HF connection cable mono L 5 m	<b>815.052</b>
	 Erbe (T series)	HF connection cable mono L 3 m	<b>815.132</b>
		HF connection cable mono L 5 m	<b>815.152</b>
<b>HF electrodes, monopolar</b> 	 Martin (M-version)/Berchtold/ Aesculap	HF connection cable mono L 3 m	<b>815.031</b>
		HF connection cable mono L 5 m	<b>815.051</b>
	 Bovie/Valleylab/Erbe (Int.)/ BOWA (Int.) R. Wolf HF surgical generator 400 kHz 2260001	HF connection cable mono L 3 m	<b>815.033</b>
		HF connection cable mono L 5 m	<b>815.053</b>
	 BOWA (Int./EU) Eschmann and other devices with 4 mm plugs R. Wolf HF surgical generator 400 kHz 2260001	HF connection cable mono L 3 m	<b>815.034</b>
		HF connection cable mono L 5 m	<b>815.054</b>

III23 || Subject to modifications. Please note that some products may not be available in all countries. Please always take note of the information that is provided with the product. For more detailed information, please consult with your contact partner or directly with Richard Wolf GmbH.

# HF CONNECTION CABLE MONO 8106xxx

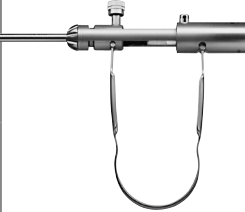
Instrument connector	Device connector		Product no.
<p><b>WOLF Instruments/surgical generator</b></p> 		<p>HF connection cable mono L 3 m</p>	<p><b>8106.032</b></p>
	<p>Erbe (ACC/ICC/VIO)/BOWA (EU) R. Wolf HF surgical generator 400 kHz 2260002</p>	<p>HF connection cable mono L 5 m</p>	<p><b>8106.052</b></p>
		<p>HF connection cable mono L 3 m</p>	<p><b>8106.132</b></p>
	<p>Erbe (T series)</p>	<p>HF connection cable mono L 5 m</p>	<p><b>8106.152</b></p>
<p><b>HF electrodes, monopolar</b></p> 		<p>HF connection cable mono L 3 m</p>	<p><b>8106.031</b></p>
	<p>Martin (M-version)/Berchtold/ Aesculap</p>	<p>HF connection cable mono L 5 m</p>	<p><b>8106.051</b></p>
		<p>HF connection cable mono L 3 m</p>	<p><b>8106.033</b></p>
	<p>Bovie/Valleylab/Erbe (Int.)/ BOWA (Int.) R. Wolf HF surgical generator 400 kHz 2260001</p>	<p>HF connection cable mono L 5 m</p>	<p><b>8106.053</b></p>
		<p>HF connection cable mono L 3 m</p>	<p><b>8106.034</b></p>
	<p>BOWA (Int./EU) Eschmann and other devices with 4 mm plugs R. Wolf HF surgical generator 400 kHz 2260001/2260002</p>	<p>HF connection cable mono L 5 m</p>	<p><b>8106.054</b></p>









**BIPO HF CONNECTION CABLE**  
8108xxx

Instrument connector	Device connector		Product no.
<p><b>WOLF</b> <b>Bipolar forceps</b></p> 		<p>HF connection cable bipo, L 3 m</p>	<p><b>8108.032</b></p>
	<p>Erbe (ACC/ICC/T)/BOWA (EU) R. Wolf HF surgical generator 400 kHz 2260001/2260002</p>	<p>HF connection cable bipo, L 5 m</p>	<p><b>8108.052</b></p>
		<p>HF connection cable bipo, L 3 m</p>	<p><b>8108.033</b></p>
	<p>Martin (Int.)/2 pin Valleylab/ BOWA (Int.) R. Wolf HF surgical generator 400 kHz 2260001/2260002</p>	<p>HF connection cable bipo, L 5 m</p>	<p><b>8108.053</b></p>
		<p>HF connection cable bipo, L 3 m</p>	<p><b>8108.031</b></p>
	<p>WOLF/Martin (M-version)/Berchtold/ Aesculap</p>	<p>HF connection cable bipo, L 5 m</p>	<p><b>8108.051</b></p>
	 <p>EMC Dolley</p>	<p>HF connection cable bipo, L 3 m</p>	<p><b>8108035</b></p>

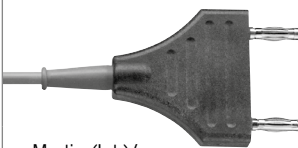
III23 || Subject to modifications. Please note that some products may not be available in all countries. Please always take note of the information that is provided with the product. For more detailed information, please consult with your contact partner or directly with Richard Wolf GmbH.

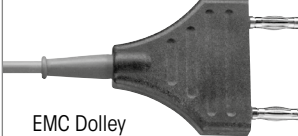
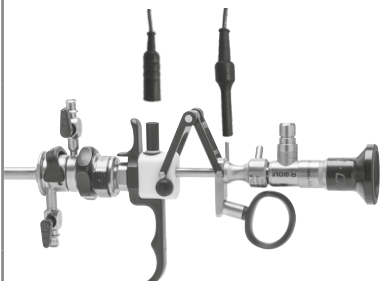

# BIPO HF CONNECTION CABLE 8108XXX

Instrument connector	Device connector		Product no.	
<b>Bipolar tweezers connection</b>  		HF connection cable bipo, L 3 m	<b>8108.132</b>	
	Erbe (ACC/ICC/T)/BOWA (EU) R. Wolf HF surgical generator 400 kHz 2260001/2260002	HF connection cable bipo, L 5 m	<b>8108.152</b>	
		HF connection cable bipo, L 3 m	<b>8108.133</b>	
	Martin (Int.)/ 2 pin Valleylab/BOWA (Int.) R. Wolf HF surgical generator 400 kHz 2260001/2260002	HF connection cable bipo, L 5 m	<b>8108.153</b>	
		HF connection cable bipo, L 3 m	<b>8108.131</b>	
	Martin (M-version)/Berchtold/ Aesculap	HF connection cable bipo, L 5 m	<b>8108.151</b>	
		HF connection cable bipo, L 3 m	<b>8108135</b>	
	EMC Dolley			
	<b>WOLF S(a)line resectoscope/</b>  		<b>Bipolar cable; TUR/TCR; WOLF</b> MF plug; L 4 m	<b>20196-119</b>
		Erbe VIO 300D		
		<b>BIPOLAR CABLE; MF-U</b> MF plug; L 4.5 m	<b>21196-119</b>	
Erbe VIO 3				
		HF connection cable bipo, L 3 m	<b>8108.231</b>	
KLS Martin		HF connection cable bipo, L 5 m	<b>8108.251</b>	
	HF connection cable bipo, L 3 m	<b>8108233</b>		
R. Wolf HF surgical generator 400 kHz 2260001/2260002	HF connection cable bipo, L 5 m	<b>8108253</b>		

# MONO HF NEUTRAL ELECTRODE CABLE

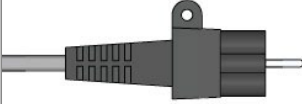
Instrument connector	Device connector		Product no.
<p><b>2-pole neutral electrode</b></p> 	 <p>R. Wolf HF surgical generator 400 kHz 2260001/2260002</p>	<p><b>Mono HF neutral electrode cable, L 4.5 m</b></p>	<p><b>2260031</b></p>

III23 || Subject to modifications. Please note that some products may not be available in all countries. Please always take note of the information that is provided with the product. For more detailed information, please consult with your contact partner or directly with Richard Wolf GmbH.

# FLEXIBLE FIBER CHOLEDOCHOSCOPE 5 MM CHANNEL 2.5 MM

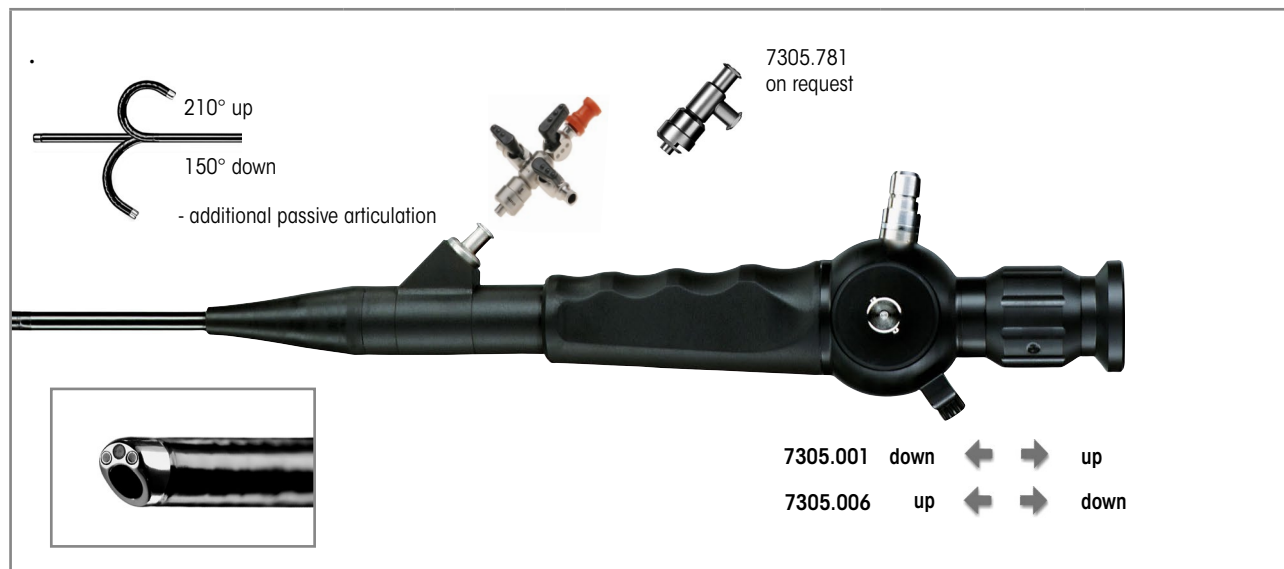

	Outer Ø	Working channel	WL	Control lever in distal direction – articulation downward	Control lever in distal direction – articulation upward	Product no.
<b>Fiber cystoscope 15 FR WL 400 mm</b> Slanted distal tip Articulation +210°/-150° Direction of view 0°, viewing angle 110°	5 mm 15 Fr	25 mm 75 Fr	400 mm	•		<b>7305.001</b>
					•	<b>7305.006</b>
<b>Fiber cystoscope bndl</b> consisting of: Fiber cystoscope 15 FR WL 400 mm (7305.001) Adapter with 2 irrigation valves and 1 instrument port (7305.782) Leakage tester for flex. endoscopes (163.903) Pressure equalization valve (163.904) Cleaning brush Ø 3 mm, TL 1,200 mm (PACK= 10 PCS) (7990002)				•		<b>730500111</b>
<b>Fiber cystoscope bndl</b> consisting of: Fiber cystoscope 15 FR WL 400 mm (7305.006) Adapter with 2 irrigation valves and 1 instrument port (7305.782) Leakage tester for flex. endoscopes (163.903) Pressure equalization valve (163.904) Cleaning brush Ø 3 mm, TL 1,200 mm (PACK= 10 PCS) (7990002)					•	<b>730500611</b>

Recommended accessories	Product no.
<b>Fiber light cable bndl</b> consisting of: Fiber light cable Ø 2.5 mm TL 2.3 m (80662523), projector-side adapter (8095.07), and endoscope-side adapter (809509)	Ø 2.5 mm, 2.3 m long <b>806625231</b>

11123 | Subject to modifications. Please note that some products may not be available in all countries. Please always take note of the information that is provided with the product. For more detailed information, please consult with your contact partner or directly with Richard Wolf GmbH.

**mamba**  
VISION

**FLEXIBLE SENSOR ENDOSCOPE FOR USE IN CHOLEDOCHOSCOPY**

FOR ENDOCAM **Logic 4K** CONTROLLER



	Outer Ø	Working channel	WL	Control lever in distal direction – articulation downward	Control lever in distal direction – articulation upward	Product no.
<b>Sensor cystoscope</b> <b>16.2 Fr WL 400 mm</b> Slanted distal tip Articulation +210°/-210° Direction of view 0°, viewing angle 120°	16.2 Fr	2.5 mm 7.5 Fr	400 mm	•		<b>7315001</b>
				•	<b>7315006</b>	
<b>Sensor cystoscope bndl</b> consisting of: Sensor cystoscope 16.2 FR, WL 400 mm (7315001) Leakage tester for flex. endoscopes (163.903), pressure equalization valve (163.904), Luer sealing cap (15023205), and cleaning brush Ø 5 mm, TL 1,200 mm (PACK= 10 PCS) (7990005)				•		<b>73150012</b>
<b>Sensor cystoscope bndl</b> consisting of: Sensor cystoscope 16.2 FR, WL 400 mm (7315006) Leakage tester for flex. endoscopes (163.903), pressure equalization valve (163.904), Luer sealing cap (15023205), and cleaning brush Ø 5 mm, TL 1200 mm (PACK= 10 PCS) (7990005)					•	<b>73150062</b>
<b>Recommended accessories</b>						<b>Product no.</b>
<b>Fiber light cable bndl</b> consisting of: Fiber light cable Ø 2.5 mm TL 2.3 m (80662523), projector-side adapter (8095.07), and endoscope-side adapter (809509)				Ø 2.5 mm, 2.3 m long		<b>806625231</b>

III23 || Subject to modifications. Please note that some products may not be available in all countries. Please always take note of the information that is provided with the product. For more detailed information, please consult with your contact partner or directly with Richard Wolf GmbH.

# TÜBINGER MIC TRAINING DEVICE

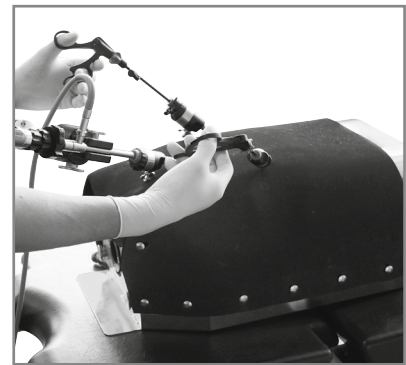
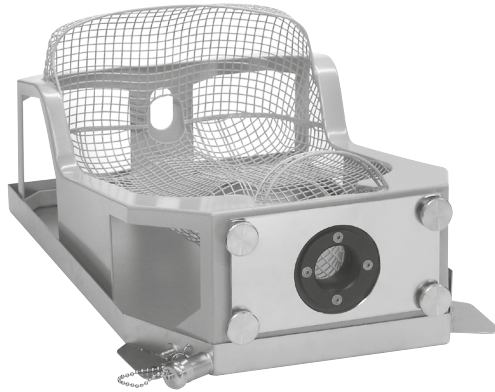

		Product no.
<b>Tübinger MIC trainer</b> with 3 abdominal walls (foam rubber)	(W x H x D) 560 x 350 x 230 mm	<b>9500.056</b>

Recommended accessories		Product no.
<b>Abdominal wall, foam rubber, PACK= 5 PCS</b>		<b>9500.051</b>
Available on request with transportation case		

