

Flexible Fiber 2-Channel Continuous-Irrigation Laser-Uretero-Renoscopes
"The COBRA"

Flexible Fiber 2-Kanal Dauerspül-Laser Uretero-Renoskope
"The COBRA"

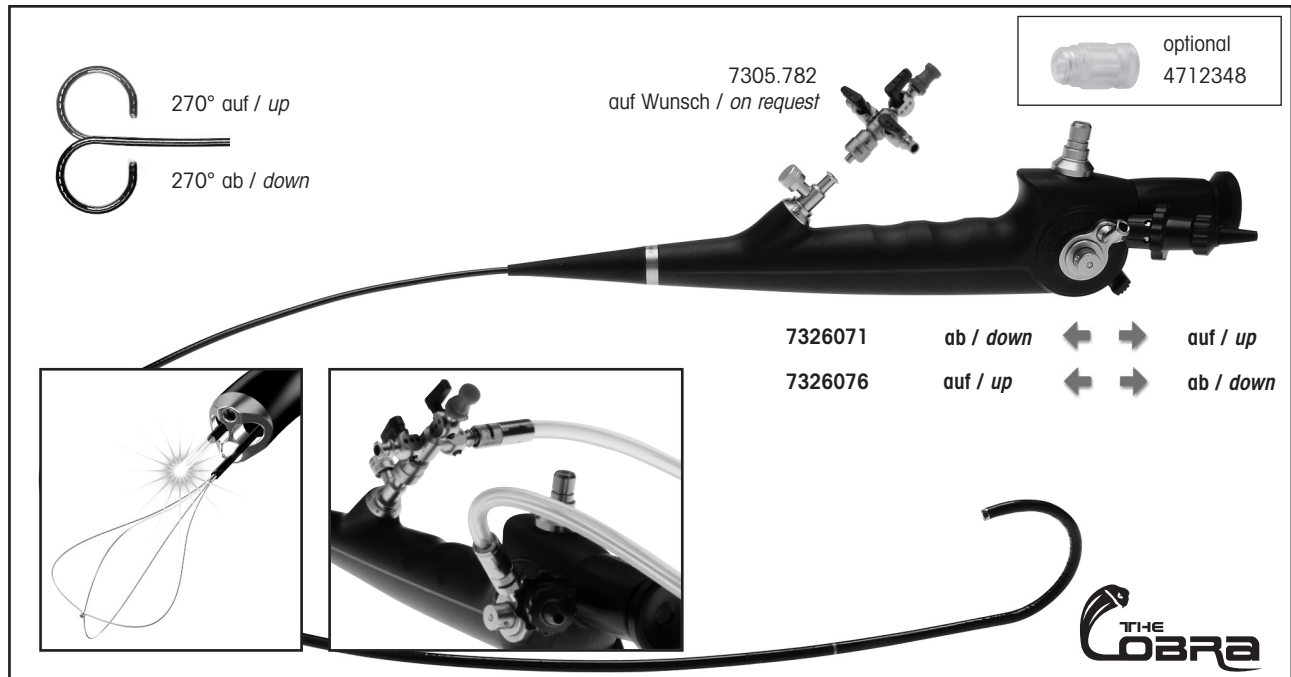

First flexible 2-channel laser uretero-rensoscope!

- Laser channel for fibres up to 365µm
- Simple control of the laser fiber with special laser shifter
- Best picture quality thanks to continuous irrigation
- Faster working without constantly changing between laser fiber and stone basket, because both can be used at the same time
- 2-channel to provide option of continuous irrigation or dual irrigation
- Brake mechanism for locking the instrument tip

Das erste flexible 2-Kanal Laser-Uretero-Renoskop!

- Laserkanal für Fasern bis zu 365µm
- Einfachste Bedienung der Laserfaser durch speziellen Laser-Shifter
- Beste Bildqualität aufgrund Dauerspülung
- Schnelleres Arbeiten ohne ständigen Wechsel von Laserfaser und Steinfangkörbchen, da beide parallel verwendet werden können
- 2 Kanäle zur Möglichkeit der Dauerspülung oder Doppelspülung
- Bremsvorrichtung zur Arretierung der Instrumentenspitze

2-Kanal Laser Uretero-Renoskop-Set <i>2-channel laser ureterorenoscope set</i>	im Set enthaltenes Uretero-Renoskop <i>Ureterorenoscope included in set</i>	NL / WL	Charr. <i>Fr.</i>	Arbeits- und Spülkanäle <i>Working and irrigation channels</i>	Bildrichtung <i>Viewing direction</i>	Blickwinkel <i>Angle of view</i>	Set
bestehend aus: 2-Kanal Laser-URS, Spannelement für Laserfaser, orange (VE = 20 Stück) (15394144), Gassteril-Ventil (163.904), Dichtigkeitstester mit Bajonett-Anschluss (163.903), Reinigungsadapter (163914), Einmal-Reinigungsbürste (VE = 10 St., 7990001)	7326071	680 mm	6 / 9.9	2 x 3.3 Charr. / Fr.	0°	85°	Steuerhebel nach distal - Abwinkelung nach unten <i>Movement of the control lever distally - articulation of the tip downward</i> 732607111
consisting of: 2-channel laser URS, spring piece for laser fibre, orange (pack of 20) (15394144), gas steri valve (163.904), leak tester with bayonet connection (163.903), cleaning adapter (163914), disposable cleaning brush (pack of 10, 7990001)	7326076						Steuerhebel nach distal - Abwinkelung nach oben <i>Movement of the control lever distally - articulation of the tip upward</i> 732607611

hierzu / also: Fiber Lichtleiter Set , Ø 2,5 mm, 2,3 m lang bestehend aus: Fiber Lichtleiter (80662523), Adapter projektorseitig (8095.07) und Adapter endoskopseitig (809509) Fiber light cable set , Ø 2.5 mm, 2.3 m long consisting of: Fiber light cable (80662523), adapter projector side (8095.07) and adapter endoscope side (809509)	806625231
---	------------------

Accessories and Accessory Instruments
for flexible single and dual channel
Ureterorenoscopes with Sensor Technology

MegaPulse Desktop 30+ Set	22860010
MegaPulse Tower 30+ Set	22860060
Uro Pump 2224 set	
<i>Pump for irrigation and continuous pressure and flow in the upper urinary tract</i>	22240011
Roller suction pump 2207 set	
<i>Pump for continuous aspiration</i>	2207.0011
ENDOCAM Logic HD Controller Set	55251081
ENDOCAM Logic HD Lite Controller Set	55252011
1CCD camera head	85525902
Zoom-Lens	85261504
<i>alternative: Pendual HD camera head</i>	5525933
Medical LCD Monitor 27"	
<i>for pin-sharp endo images</i>	LMD-2765NB
<i>optional:</i>	
Monitor Stand	5370.0190

Zubehör und Hilfsinstrumente
zum 2-Kanal Uretero-Renokope
mit Sensor-Technologie

MegaPulse Desktop 30+ Set	22860010
MegaPulse Tower 30+ Set	22860060
Uro Pump 2224-Set	
<i>Pumpe zur Irrigation für kontinuierlichen Druck und Flow im oberen Harntrakt</i>	22240011
Rollensaugpumpe 2207-Set	
<i>Pumpe zur kontinuierlichen Aspiration</i>	2207.0011
ENDOCAM Logic HD Controller Set	55251081
ENDOCAM Logic HD Lite Controller Set	55252011
1CCD Kamerakopf	85525902
Zoom-Objektiv	85261504
<i>alternativ: Pendual HD Kamerakopf</i>	5525933
Medizinischer LCD-Monitor 27"	
<i>für gestochen scharfe Endobilder</i>	LMD-2765NB
<i>optional:</i>	
Monitor-Standfuß	5370.0190

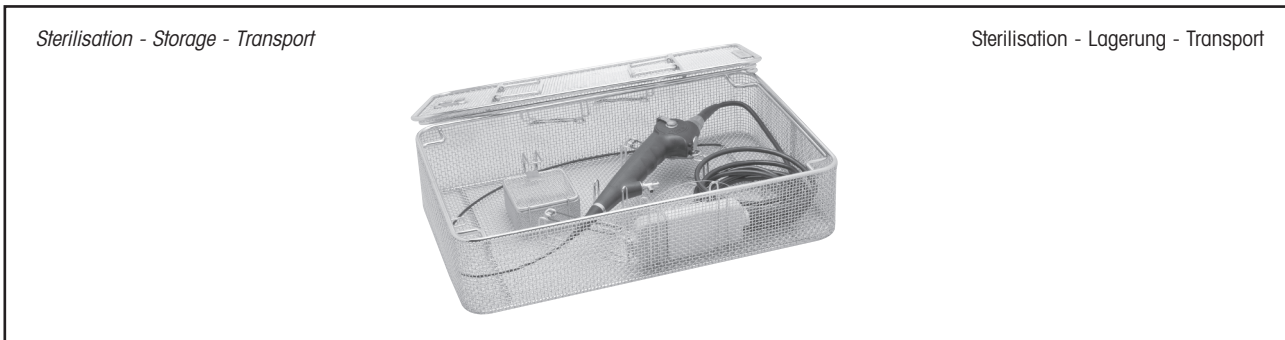

Sterilization basket for flexible endoscopes
consisting of:
Basket lower part with integrated small parts basket,
brackets and silicone O-rings,
basket lid with spring clip and 2 handles
Dimensions (W x H x D): 448 x 288 x 106mm







Replacement O-ring Set	643301261
-------------------------------------	-----------

Sterilisationskorb flexible Endoskope
bestehend aus:
Siebkorbunterteil mit integriertem Kleinteilesieb,
Halterungen und O-Ringen aus Silikon; Siebkorbdeckel
mit Federverschluss und 2 Griffen
Abmessungen (B x H x T): 448 x 288 x 106 mm

Ersatz O-Ring-Set	643301261
--------------------------------	-----------

Accessories and Accessory Instruments
for flexible 2-channel continuous-irrigation laser URS
"The COBRA"

Zubehör und Hilfsinstrumente
zum flexiblen 2-Kanal Dauerspül Laser-URS
"The COBRA"

	Außen - Ø Outer - Ø	NL WL	Typen Types
Probe-Exzisionszange <i>Biopsy forceps</i> 	1.0 mm 3 Charr. / Fr.	920 mm	829.601
Fremdkörper-Fasszange <i>Foreign body forceps</i> 	1.0 mm 3 Charr. / Fr.	920 mm	828.651
Knopfelektrode <i>Button electrode</i> 	1.0 mm 3 Charr. / Fr.	920 mm	8741.80
Einmalgebrauch-Laserfaser für Nierensteine mit MegaPulse 30+ Laser, einzel steril verpackt <i>Disposable laser fibers</i> for kidney stones with MegaPulse 30+ laser, packed singly, sterile	200 µm		487501200
	272 µm		487501272
Mehrfachgebrauch-Laserfaser für Nierensteine mit MegaPulse 30+ Laser, einzel steril verpackt <i>Reusable laser fibers</i> for kidney stones with MegaPulse 30+ laser, packed singly, sterile	200 µm		87501200
	272 µm		87501272
Ansatz mit Instrumenten-Einführungshahn <i>Attachment with instrument insertion tap</i> 			7305.782
Steriles Universal Dichtventil (VE = 5 St.) zum Einführen von Hilfsinstrumenten von 1 – 6 Charr. <i>Sterile universal sealing valve</i> (pack of 5) for inserting auxiliary instruments of 1 – 6 Fr.			4712348
Tuohy-Borst Adapter, steril mit Zuspritzteil, mit männlichem Luer-Lock Ansatz (VE = 20 St.) <i>Tuohy-Borst Adapter, sterile</i> with injection part, with male Luer-lock fitting (pack of 20)			413910
Adapter für maschinellen Dichtigkeitstest <i>Adapter for automatic leak test</i> 			163.905
Zum Verschließen des 2. Luer-Anschlusses: Luer-Verschlusskappe <i>For closing the 2nd luer connector: luer sealing cap</i> 			15023205
Laserverstelleinheit, kpl. <i>Laser adjustment unit, complete</i> 			15369108
hierzu: Spannelement, orange (VE = 20 St.) <i>Clamping element, orange</i> (pack of 20)			15394144
Spülset V mit Doppel-Luer-Lock-Schlauchteil <i>Cleaning set V</i> with double luer lock tube connector			163910 (2x)

Weitere Einwegprodukte siehe Seite / Further disposables see page D 800

*Flexible Fiber-Uretero-Renoscopes
270°, "The Viper"*

Flexible Fiber-Uretero-Renoskope
270°, "The Viper"

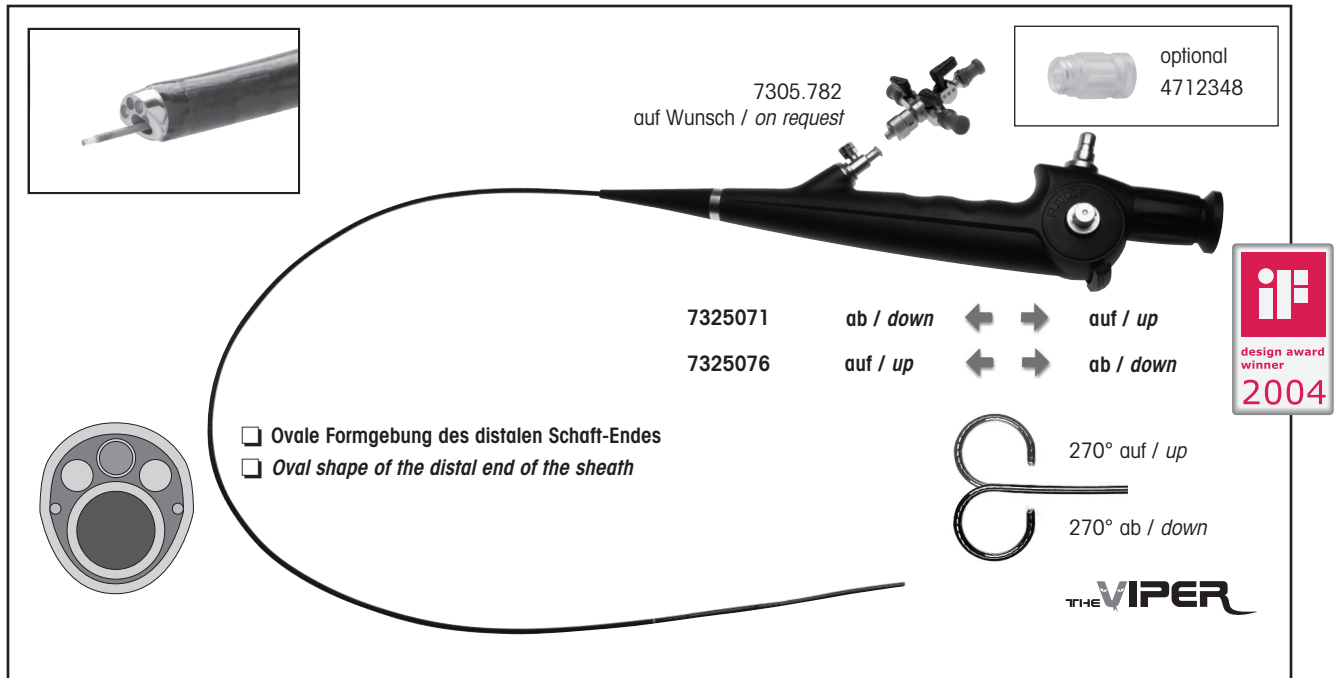

- | | |
|--|---|
| <input type="checkbox"/> Atraumatic adapted instrument tip | <input type="checkbox"/> Atraumatische Instrumentenspitze |
| <input type="checkbox"/> Design Award Winner 2004 | <input type="checkbox"/> Design Award Winner 2004 |
| <input type="checkbox"/> Ergonomical handle design | <input type="checkbox"/> Ergonomisches Griffdesign |
| <input type="checkbox"/> A convincing image | <input type="checkbox"/> Ein überzeugendes Bild |
| <input type="checkbox"/> Active angulation of 270° in either direction and additional passive angulation | <input type="checkbox"/> Aktive Abwinkelung von beidseitig 270° und zusätzliche passive Abwinkelung |
| <input type="checkbox"/> Universal Luer connector | <input type="checkbox"/> Universal Luer Anschluss |

Flexibles Fiber Uretero-Renoskop 270°-Set <i>Flexible fiber uretero-rensoskope 270° set</i>	im Set enthaltenes Uretero-Renoskop <i>included in set Uretero-rensoskope</i>	Nutzlänge <i>Working length</i>	Charr. <i>Fr.</i>	Arbeits- und Spülkanäle <i>working and irrigation channels</i>	Bildrichtung <i>viewing direction</i>	Blickwinkel <i>angel of view</i>	Set
bestehend aus: Flexibles Fiber-URS, Dichtigkeitslester mit Bajonett-Anschluss (163.903), Gassteri-Ventil (163.904), Einmal-Reinigungsbürste (VE = 10 St., 7990001) und Koffer	7325.071	680 mm	6 / 8.8	3.6 Charr. / Fr.	0°	85°	Steuerhebel nach distal - Abwinkelung nach unten <i>Forward movement of the control lever - downward movement of the tip</i> 73250711
consisting of: Flexible fiber URS, leak tester with bayonet connection (163.903), gas steri valve (163.904), disposable cleaning brush (pack of 10, 7990001) and case	7325.076						Steuerhebel nach distal - Abwinkelung nach oben <i>Forward movement of the control lever - upward movement of the tip</i> 732507611
hierzu / also: Fiber Lichtleiter Set , Ø 2,5 mm, 2,3 m lang bestehend aus: Fiber Lichtleiter (80662523), Adapter projektorseitig (8095.07) und Adapter endoskopseitig (809509) Fiber light cable set , Ø 2.5 mm, 2.3 m long consisting of: Fiber light cable (80662523), adapter projector side (8095.07) and adapter endoscope side (809509)							806625231

Hilfsinstrumente siehe Seite / Accessory instruments see page D 336 - D 337

Accessories and Accessory Instruments

for Flexible Fiber Uretero-Renoscope 270°
"The Viper"

MegaPulse Desktop 30+ Set	22860010
MegaPulse Tower 30+ Set	22860020
Uro Pump 2224 set Pump for irrigation and continuous pressure and flow in the upper urinary tract	22240011
Roller suction pump 2207 set Pump for continuous aspiration	2207.0011
ENDOCAM Logic HD Controller Set	55251081
1CCD camera head	85525902
Zoom-Lens	85261504
alternativ: Pendual HD camera head	5525933
Medical LCD Monitor 27" für pin-sharp endo images	LMD-2765NB
optional: Monitor Stand	5370.0190

Zubehör und Hilfsinstrumente

zum Fiber-Uretero-Renoskop 270°
"The Viper"

MegaPulse Desktop 30+ Set	22860010
MegaPulse Tower 30+ Set	22860020
Uro Pump 2224-Set Pumpe zur Irrigation für kontinuierlichen Druck und Flow im oberen Harntrakt	22240011
Rollensaugpumpe 2207-Set Pumpe zur kontinuierlichen Aspiration	2207.0011
ENDOCAM Logic HD Controller Set	55251081
1CCD Kamerakopf	85525902
Zoom-Objektiv	85261504
alternativ: Pendual HD Kamerakopf	5525933
Medizinischer LCD-Monitor 27" für gestochen scharfe Endobilder	LMD-2765NB
optional: Monitor-Standfuß	5370.0190

Sterilisation - Storage - Transport

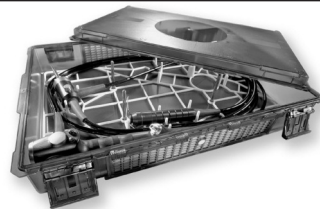

Sterilisation - Lagerung - Transport

Sterisafe DURO A3-Set,
für **plasma sterilization** consisting of:
Sterisafe DURO A3 (382031003),
Toolsafe Lattice base (382031101),
Disposable filter for H₂O₂ (pack of 100, 382031401) .. 382032000
Sterisafe DURO A3-Set,
für **EO (ethylene oxide) and FA (formaldehyde)** consisting of:
Sterisafe DURO A3 (382031003), Toolsafe Lattice base (382031101),
Disposable filter for EO and FA (pack of 100, 382031501) .. 382032100
Accessories:
Disposable filter, pack of 100,
für H₂O₂ .. 382031401
für EO und FA .. 382031501
Seal of approval label, pack of 500,
für H₂O₂ .. 382031220
Sterisafe universal label holder .. 382031203
Lead-wire seal, pack of 100 .. 382031202

Sterisafe DURO A3-Set,
für **Plasma-Sterilisation** bestehend aus:
Sterisafe DURO A3 (382031003),
Toolsafe Gitterunterlage (382031101),
Einwegfilter für H₂O₂ (VE=100 St., 382031401) 382032000
Sterisafe DURO A3-Set,
für **EO und FA** bestehend aus:
Sterisafe DURO A3 (382031003), Toolsafe Gitterunterlage (382031101),
Einwegfilter für EO und FA (VE=100 St., 382031501) 382032100
Zubehör:
Einwegfilter, VE=100 St.,
für H₂O₂ .. 382031401
für EO und FA .. 382031501
Siegeletikett, VE=500 St.,
für H₂O₂ .. 382031220
Sterisafe Universal Etikettenhalter .. 382031203
Sicherungsplombe, VE=100 St. 382031202

Technical information:
Outer dimensions (L x W x H): 450 x 292 x 87 mm
Inside dimensions (L x W x H): 420 x 265 x 75 mm

Technische Informationen:
Außenmaße (L x B x H): 450 x 292 x 87 mm
Innenmaße (L x B x H): 420 x 265 x 75 mm

Sterilisation - Storage - Transport

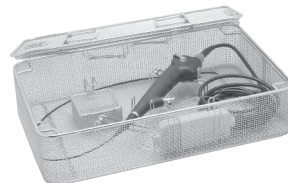









Sterilisation - Lagerung - Transport

Sterilization basket for flexible endoscopes
consisting of:
Basket lower part with integrated small parts basket,
brackets and silicone O-rings,
basket lid with spring clip and 2 handles
Dimensions (W x H x D): 448 x 288 x 106mm 85841240
Replacement O-ring Set .. 643301261

Sterilisationskorb flexible Endoskope
bestehend aus:
Siebkorbunterteil mit integriertem Kleinteilesieb,
Halterungen und O-Ringen aus Silikon; Siebkorbdeckel
mit Federverschluss und 2 Griffen
Abmessungen (B x H x T): 448 x 288 x 106 mm 85841240
Ersatz O-Ring-Set .. 643301261

Accessories and Accessory Instruments
for Flexible Fiber Uretero-Renoscope 270°
"The Viper"

Zubehör und Hilfsinstrumente
zum Fiber-Uretero-Renoskop 270°
"The Viper"

	Außen - Ø Outer - Ø	NL WL	Typen Types
Probe-Exzisionszange <i>Biopsy forceps</i> 	1.0 mm 3 Charr. / Fr.	920 mm	829.601
Fremdkörper-Fasszange <i>Foreign body forceps</i> 	1.0 mm 3 Charr. / Fr.	920 mm	828.651
Knopfelektrode <i>Button electrode</i> 	1.0 mm 3 Charr. / Fr.	920 mm	8741.80
Einmalgebrauch-Laserfaser für Nierensteine mit MegaPulse 30+ Laser, einzeln steril verpackt <i>Disposable laser fibers for kidney stones with MegaPulse 30+ laser, packed singly, sterile</i>	200 µm		487501200
	272 µm		487501272
Mehrfachgebrauch-Laserfaser für Nierensteine mit MegaPulse 30+ Laser, einzeln steril verpackt <i>Reusable laser fibers for kidney stones with MegaPulse 30+ laser, packed singly, sterile</i>	200 µm		87501200
	272 µm		87501272
Ansatz mit Instrumenten-Einführungshahn <i>Attachment with instrument insertion tap</i> 			7305.782
Steriles Universal Dichtventil (VE = 5 St.) zum Einführen von Hilfsinstrumenten von 1 – 6 Charr. <i>Sterile universal sealing valve (pack of 5)</i> for inserting auxiliary instruments of 1 – 6 Fr. 			4712348
Tuohy-Borst Adapter, steril mit Zuspritzteil, mit männlichem Luer-Lock Ansatz (VE = 20 St.) <i>Tuohy-Borst Adapter, sterile</i> with injection part, with male Luer-lock fitting (pack of 20) 			413910
Adapter für maschinellen Dichtigkeitstest <i>Adapter for automatic leak test</i> 			163.905
Zum Verschließen des 2. Luer-Anschlusses: Luer-Verschlusskappe For closing the 2nd luer connector: <i>luer sealing cap</i> 			15023205
Spülset V mit Doppel-Luer-Lock-Schlauchteil <i>Cleaning set V with double luer lock tube connector</i> 			163910