

Imaging

Imaging

1

ENDOCAM

2

Accessories

3

Lenses

4

Monitors

5

Light sources

6

Light cables

7

Adapters

8

Documentation

9

Device carts

ENDOCAM Logic 4K

Camera controller



- 4K resolution with either 3840 x 2160 pixels or 4096 x 2160 pixels
- Continuous processing of captured 4K imaging data with 4K resolution
- Optimally matched system consisting of telescopes, lenses, camera head, camera controller, light source, light cables and monitors
- All available light sources and applied parts of the ENDOCAM Logic HD are compatible with the ENDOCAM Logic 4K Controller and can continue to be used
- Dialog function:
 1. Control of connected, dialog-capable ENDOLIGHT light source for optimum illumination with maximum protection for the endoscope
 2. Monitor display of major parameters for further devices (e.g. pressure indication, sei flow, residual gas display)
- USB port on camera controller for directly saving HD images and HD videos to USB storage media
- Including "Special Imaging Modes" (SIM) for enhanced tissue differentiation
- Extremely easy to use thanks to pre-programming of clinically-devised presets for various disciplines, effortless saving of personal settings
- Patient data can be entered via a USB keyboard
- Direct printing possible
- Future-proof investment, updates can be imported at any time via the USB port
- Central component of the **core nova** OP Integration

ENDOCAM Logic 4K camera controller
bndl **55253011**

Comprising:

1x ENDOCAM Logic 4K camera controller	5525301
1x hand-held remote control	5525401
1x USB flash memory 32GB	72321829
1x HDMI/HDMI cable, lockable, 3.0 m	103847
1x power cable	2440.03

VIII23 || Subject to modifications. Please note that some products may not be available in all countries. Please always take note of the information that is provided with the product. For more detailed information, please consult with your contact partner or directly with Richard Wolf GmbH.

ENDOCAM Logic 4K

Technical data of camera controller

Camera controller		5525301		
Device properties				
Type of controls	Touchscreen			
Max. video signal resolution	4096 x 2160 pixels			
White balance, color temperature range	2300 K to 7000 K			
Noise level	34 dB to 48 dB max.			
Digital zoom	1.5x max.			
Individually configurable profiles	at least 5 profiles			
Brightness control	Automatic shutter control + automatic gain control			
Image format of saved pictures / videos	JPEG, TIFF (max. 1920 x 1200) / MPEG4 (max. 1920 x 1080/60P)			
Operating conditions	+10°C to +40°C, 30% to 75% rel. humidity, atmospheric pressure 700 hPa to 1060 hPa			
Operating mode	Continuous operation			
Equipment				
IP rating	IP20			
Cooling method	Controlled fan			
Power supply				
Mains + frequency	100-240 VAC, 50/60 Hz			
Power consumption	120 VA			
Current rating	max. 1.2 A			
Regulatory standards				
Safety	US/ CA: UL 2601-1 / CSA C22.2 NO.601.1, EU: EN 60601			
EMC	EN 60601-1-2 / IEC 601-1-2			
Medical device class	Class 1			
Classification of applied part	CF			
Interfaces				
Video outputs	2x HDMI 4K, 2x HDMI HD, 2x 3G-HD-SDI			
PIP input	1x 3G-HD-SDI			
Remote output	2 x 3.5 mm jack, stereo			
USB port (on front panel, for external storage media)	USB 2.0 (FAT32/NTFS formatting)			
Resolution (HDMI output)	Adjustable in the user menu 1280 x 1024/60P (5:4) 1920 x 1080/60P (16:9) 1920 x 1200/60P (16:10) Only for HDMI 4K: 4K 3840 x 2160/60P (16:9) 4K 4096 x 2160/60P (17:9)			
Resolution (3G-HD-SDI output)	Adjustable in the user menu 1280 x 720/50P (16:9) 1920 x 1080/50I (16:9) 1920 x 1080/50P (16:9) 1280 x 720/50P (16:9) 1920 x 1080/50I (16:9) 1920 x 1080/60P (16:9)			
Resolution of picture-in-picture input (3G-SDI)	1280 x 720/50P (16:9) 1280 x 720/60P (16:9)	720 x 486/60I (16:9) 720 x 576/50I (16:9)	1920 x 1080/50P (16:9) 1920 x 1080/60P (16:9)	1920 x 1080/50I (16:9) 1920 x 1080/60I (16:9)
Dimensions and weights				
Weight	6.2 kg			
Dimensions (W x H x D)	300 x 120 x 416 mm			

ENDOCAM Logic 4K

3-chip 4K camera head

ENDOCAM
1



- Digital image processing and digital signal transmission
- 2 programmable camera head buttons with 4 available functions
- Ergonomic handling due to smaller, weight-saving design compared to previous HD camera heads
- Production using 3D printer
- Improved heat dissipation makes the device more pleasant to handle
- Universal C-Mount lens connection
- Service-friendly design: camera cable can be replaced on site by technician
- Steam-sterilizable
- Can be reprocessed by machine
- Suitable for low-temperature procedure

ENDOCAM Logic 4K camera head **85525942**
3-chip type, cable length 3 m

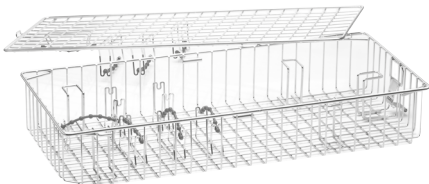
Recommended accessories	Product no.	
	<p>Perforated basket for camera head (L x W x H) 448 x 200 x 73 mm</p>	<p>38002</p>

VIII23 || Subject to modifications. Please note that some products may not be available in all countries. Please always take note of the information that is provided with the product. For more detailed information, please consult with your contact partner or directly with Richard Wolf GmbH.

ENDOCAM Logic 4K

Technical data of camera head

ENDOCAM

Camera head		85525942
Device properties		
Sensor	3x 1/3" CMOS	
Operation	2 programmable head buttons with 4 functions	
Operating conditions	+10°C to +30°C, 20% to 75% rel. humidity, atmospheric pressure 700 hPa to 1060 hPa	
Equipment		
Thread for objective lens	C-Mount	
Degree of protection against the ingress of moisture	IPX7	
Service	Camera head cable and eyepiece snap-in coupling can be replaced on site	
Dimensions and weight		
Camera head weight (without cable)	121 g	
Housing dimensions (W x H) - without cable and anti-kink protection	40 x 47 mm	
Camera head length (without cable)	102 mm	
Cable length	3 m	
Cable outlet	30°	

VIII23 || Subject to modifications. Please note that some products may not be available in all countries. Please always take note of the information that is provided with the product. For more detailed information, please consult with your contact partner or directly with Richard Wolf GmbH.

ENDOCAM Logic 4K Lenses

RIWO lens with snap-on mechanism and C-Mount thread, steam-sterilizable and reprocessable by machine		Product no.
 <p>AUTOCLAVE 134° C / 273° F</p>	<p>RIWO lens F 14mm f = 14 mm</p>	85261144
	<p>RIWO lens F 24mm f = 24 mm</p>	85261244
RIWO zoom lens with snap-on mechanism and C-Mount thread, steam-sterilizable and reprocessable by machine		
 <p>AUTOCLAVE 134° C / 273° F</p>	<p>RIWO zoom lens F 13-29mm f = 13-29 mm</p>	85261504
RIWO angular lens with rotatable snap-on mechanism and C-Mount thread, suspension function, suitable for reprocessing by machine and low-temperature procedure		
	<p>RIWO angled lens F 14mm f = 14 mm</p>	5257141
	<p>RIWO angled lens F 17mm f = 17 mm</p>	5257171

ENDOCAM Logic 4K

Compatible applied parts and camera heads from the ENDOCAM Logic family

ENDOCAM
1



- ENDOCAM Logic 4K camera head 3-chip (85525942)
- ENDOCAM Logic HD camera head 3-chip (85525922/923)
- ENDOCAM Logic HD camera head 1-chip (85525902)
- ENDOCAM Logic HD pendual camera head (5525933)
- ENDOCAM Logic HD pendual camera head **blue** (5525833)
- ENDOCAM Logic HD camera head **green** (85525812)
- Flexible sensor ureterorenoscope "COBRA Vision" (7356071/076)
- Flexible sensor ureterorenoscope "BOA Vision" (7355071/076)
- Flexible sensor cystoscope "MAMBA Vision" (7315001/006)

ENDOCAM Logic 4K

Overview

ENDOCAM Logic 4K Camera Controller

bndl 55253011

Comprising:

1x ENDOCAM Logic 4K Camera Controller 5525301
 1x hand-held remote control USB 5525401
 1x USB flash memory 32GB 72321829
 1x HDMI/HDMI cable, lockable, 3.0 m 103847
 1x power cable 2240.03

ENDOCAM Logic 4K camera head 85525942

RIWO lenses, C-Mount

f = 14 mm 85261144

f = 24 mm 85261244

f = 13 - 29 mm 85261504

RIWO zoom lens, C-Mount

f = 13 - 29 mm 5261504

Light source LED 2.2 bndl 51640011

Comprising:

1x ENDOLIGHT LED 2.2, 80 W 5164001
 1x patch cable, RJ45 SFTP, 0.5m 72325378
 1x power cable 2440.03

PANOVIEW ULTRA telescope, Ø 5.5 mm,

WL 300 mm

0° 8935461

30° **8935462**

WL 430 mm

0° 89354416

30° **89354426**

PANOVIEW ULTRA telescope, Ø 10 mm,

WL 305 mm

0° 8934461

30° **8934462**

50° **8934463**

WL 440 mm

0° 89344416

30° **89344426**

50° **89344436**

Fusion fiber light cable, bndl, Ø 5.0 mm

2.3 m 806550231

3.0 m 806550301

3.5 m 806550351

Comprising:

1x adapter, projector to light cable 8095.07
 1x adapter, light cable to endoscope 809509
 1x Fusion fiber light cable 806550xx

LCD monitor 4K

31" LMD-X310NB

55" LMD-X550NB

Protective cover for monitor

31" 53700031

55" 53700055

Flightcase

for 55" monitor 155831669

Mini Cleanboard USB

wipe-clean USB keyboard incl. mouse pad

German (QWERTZ) 103823

US/English (QWERTY) 103824

Digital color printer SONY UP-DR80MD 5651051

Color photo print package DIN-A4 UPC-R80MD 5651926

4K signal channel for distances greater than 5 m

DTP transmitter DTP HDMI 4K 330 TX

DTP receiver DTP HDMI 4K 330 RX

Cable HDMI / HMDI 0.5 m HDMI-MM-0.5MG-UF

Medical-grade power supply unit 36 W PS 1230 MD

Shielded twisted-pair cable 0.9 m XTP DTP 24/3

Shielded twisted-pair cable 7.6 m XTP DTP 24/25

Shielded twisted-pair cable 22.4 m XTP DTP 24/75

Shielded twisted-pair cable 30.4 m XTP DTP 24/100

ENDOCAM Logic 4K

System overview

ENDOCAM
1

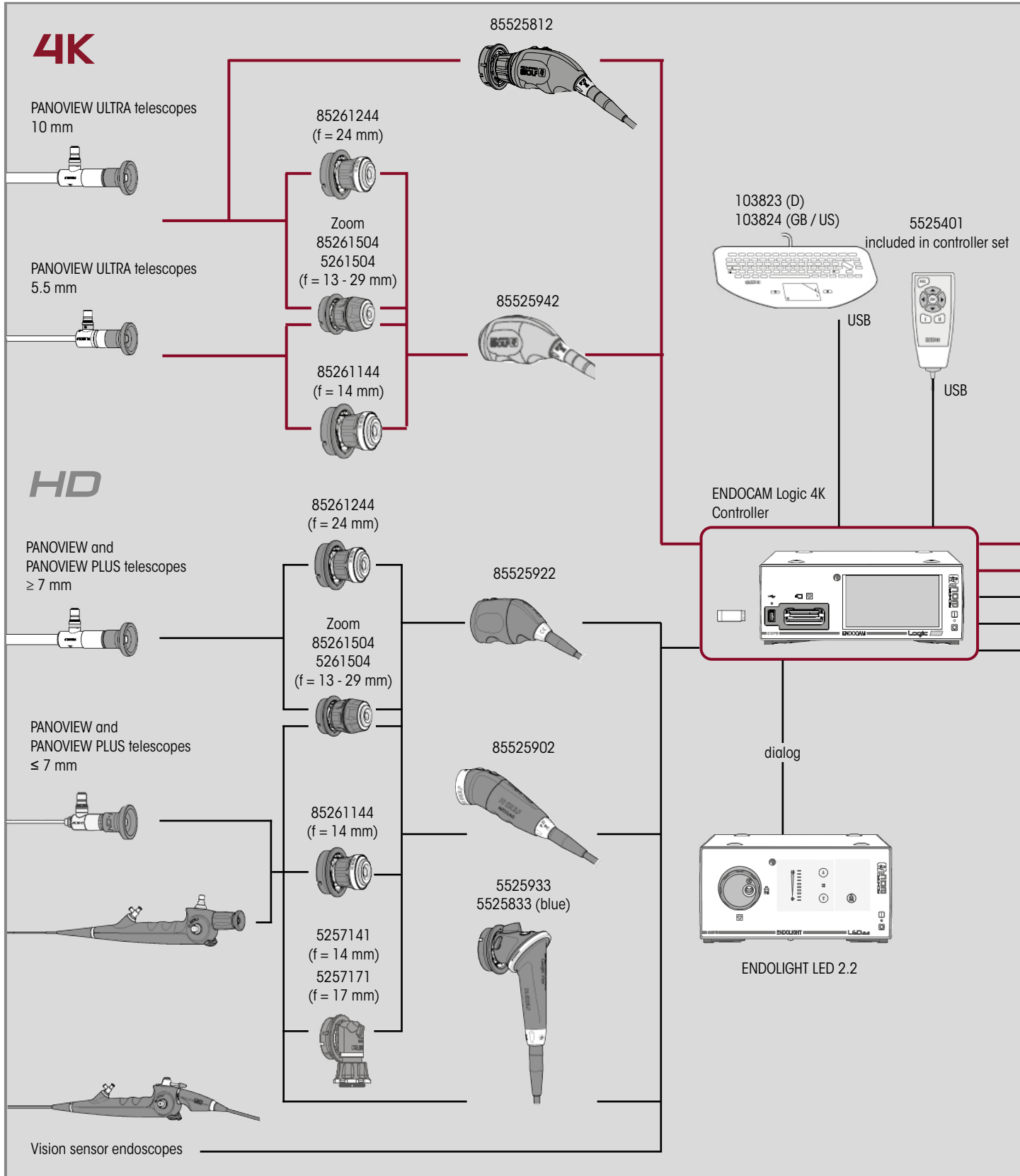

VIII23 || Subject to modifications. Please note that some products may not be available in all countries. Please always take note of the information that is provided with the product. For more detailed information, please consult with your contact partner or directly with Richard Wolf GmbH.

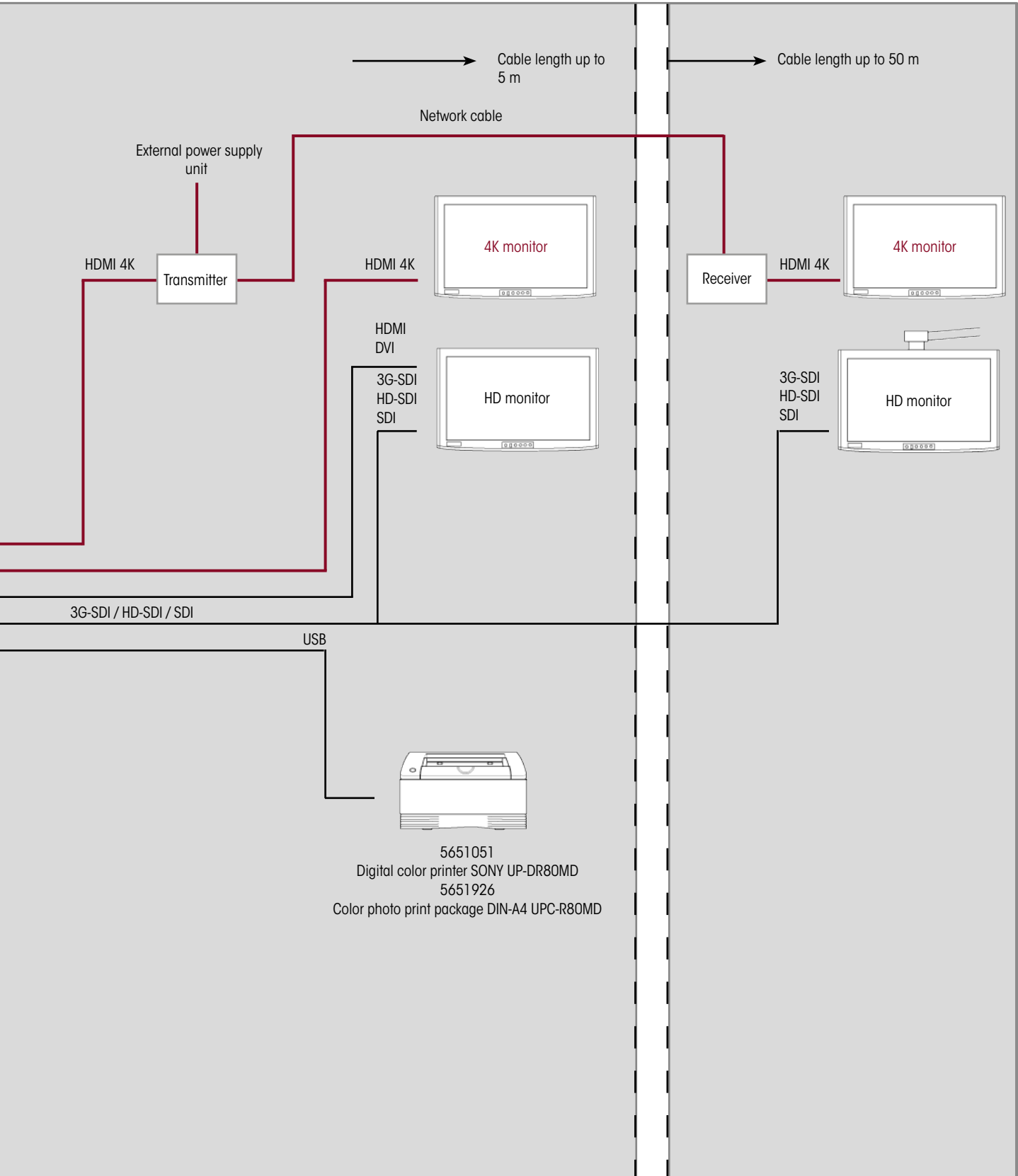

ENDOCAM Logic HD

Camera controller

ENDOCAM



- Various equipment variants. The variants exclusively refer to the configuration of output and input signals
- Digital signal processing
- Outstandingly wide range of application due to integration of various applied parts and diagnostic methods
- updates can be applied at any time via USB port
- Storage of high-resolution images and HD videos* on USB storage media
- Integration of further image signals via picture-in-picture port (3G-SDI)
- Specialized for use in integrated operating rooms as a central **core nova module**

- User-friendly. Clinically-devised presets are pre-programmed for various disciplines. This includes applications using standard and fiber endoscopes as well as sensor endoscopes with chip-on-the-tip technology. Personal settings can easily be saved as well
- Maximum flexibility: The resolution of all signal outputs can be adapted individually to the connected system
- Patient data can be entered using the connected USB keyboard
- Direct printing possible
- Modern, clearly arranged on-screen menu
- Dialog function:
 1. Control of connected ENDOLIGHT light source for optimum illumination with maximum protection for the endoscope
 2. Monitor display of major device parameters for further devices (pressure indication, set flow, residual gas display, etc.)

ENDOCAM Logic HD controller bndl

Comprising:

1x ENDOCAM Logic HD controller	552510x
1x hand-held remote control USB	5525401
1x USB flash memory 8 GB	56540028
1x CAN-BUS terminator	5590.989
1x HDMI / DVI-D cable, lockable, 3.0 m	103843
1x power cable	2440.03

Controller equipment variants:

2x HDMI out	55251011
2x HDMI out / 2x 3G-SDI out	55251051
2x HDMI out / 2x 3G-SDI out / PIP in	55251061
2x HDMI out / 2x 3G-SDI out / analog out.....	55251071
2x HDMI out / 2x 3G-SDI out / PIP in / analog out	55251081

* (only for variants 5525105 to 5525106)

VIII23 || Subject to modifications. Please note that some products may not be available in all countries. Please always take note of the information that is provided with the product. For more detailed information, please consult with your contact partner or directly with Richard Wolf GmbH.

ENDOCAM Logic HD

Technical data of camera controller

Camera controller		552510x		
Device properties				
Type of controls	Touchscreen			
Max. video signal resolution	1920 x 1200 pixels			
White balance, color temperature range	2300 K to 7000 K			
Noise level	34 dB to 48 dB max.			
Digital zoom	1.5x max.			
Individually configurable profiles	at least 5 profiles			
Brightness control	Automatic shutter control + automatic gain control			
Image format of saved pictures / videos	JPEG, TIFF (max. 1920 x 1080) / MPEG4 (max. 1920 x 1080)			
Operating conditions	+10°C to +40°C, 30% to 75% rel. humidity, atmospheric pressure 700 hPa to 1060 hPa			
Operating mode	Continuous operation			
Equipment				
IP rating	IP20			
Cooling method	Controlled fan			
Power supply				
Mains + frequency	100-240 VAC, 50/60 Hz			
Power consumption	100 VA			
Current rating	max. 1.0 A			
Regulatory standards				
Safety	US/ CA: UL 2601-1 / CSA C22.2 NO.601.1, EU: EN 60601			
EMC	EN 60601-1-2 / IEC 601-1-2			
Medical device class	Class 1			
Classification of applied part	CF			
Interfaces				
Video outputs	2x 3G-SDI, 2x HDMI, 1x YC, 1x CV			
PiP input	1x 3G-HD-SDI			
Remote output	2 x 3.5 mm jack, stereo			
USB port (on front panel, for external storage media)	USB 2.0 (FAT32/NTFS formatting)			
Resolution (HDMI output)	Adjustable in the user menu 1280 x 1024/60P (5:4) 1920 x 1080/60P (16:9) 1920 x 1200/60P (16:10)			
Resolution (3G-SDI output) also supports HD-SDI	Adjustable in the user menu 1280 x 720/50P (16:9) 1920 x 1080/50I (16:9) 1920 x 1080/50P (16:9) 1280 x 720/60P (16:9) 1920 x 1080/60I (16:9) 1920 x 1080/60P (16:9)			
Resolution of SD outputs for video (Composite) and S-Video (Y/C)	Adjustable in the user menu PAL 720 x 576/50I (4:3) NTSC 720 x 486/59.94I (4:3)			
Resolution of picture-in-picture input (3G-SDI)	1280 x 720/50P (16:9) 1920 x 1080/50I (16:9) 1920 x 1080/50P (16:9) 1280 x 720/60P (16:9) 1920 x 1080/60I (16:9) 1920 x 1080/60P (16:9)			
Dimensions and weights				
Weight	6.2 kg			
Dimensions (W x H x D)	300 x 120 x 416 mm			

ENDOCAM Logic HD

3-chip HD camera head

ENDOCAM
1



- Digital image processing and digital signal transmission
- 2 programmable camera head buttons with 4 available functions
- Universal C-Mount lens connection
- Cable outlet angled at 30°
- Camera head cable can be replaced in the hospital by technicians
- Steam-sterilizable
- Can be reprocessed by machine
- Suitable for low-temperature procedure

ENDOCAM Logic HD camera head **85525922**

3-chip type, cable length 3 m

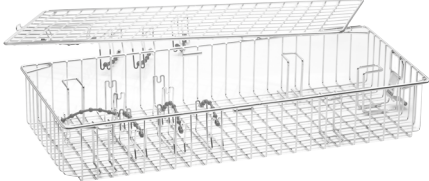
Recommended accessories	Product no.	
RIWO lens	C-Mount, f = 14 mm	85261144
	C-Mount, f = 24 mm	85261244
RIWO zoom lens	C-Mount, f = 13 - 29 mm	85261504
	Perforated basket for camera head (L x W x H) 448 x 200 x 73 mm	38002

VIII23 || Subject to modifications. Please note that some products may not be available in all countries. Please always take note of the information that is provided with the product. For more detailed information, please consult with your contact partner or directly with Richard Wolf GmbH.

ENDOCAM Logic HD

Technical data of camera head

ENDOCAM
1

Camera head		85525922
Device properties		
Sensor	3x 1/3" CCD	
Operation	2 programmable head buttons with 4 functions	
Operating conditions	+10°C to +30°C, 20% to 75% rel. humidity, atmospheric pressure 700 hPa to 1060 hPa	
Equipment		
Thread for objective lens	C-Mount	
Degree of protection against the ingress of moisture	IPX7	
Service	Cable and eyepiece snap-in coupling can be replaced on site	
Dimensions and weight		
Camera head weight (without cable)	170 g	
Housing dimensions (W x H) - without cable and anti-kink protection	43 x 53 mm	
Camera head length (without cable)	105 mm	
Cable length	3 m / 5 m	
Cable outlet	30°	

VIII23 || Subject to modifications. Please note that some products may not be available in all countries. Please always take note of the information that is provided with the product. For more detailed information, please consult with your contact partner or directly with Richard Wolf GmbH.

ENDOCAM Logic HD

1-chip HD camera head

ENDOCAM



- Digital image processing and signal transmission
- 2 programmable camera head buttons with 4 available functions
- Universal C-Mount lens connection
- Cable outlet angled at 30°
- Camera head cable can be replaced in the hospital by technicians
- Steam-sterilizable
- Can be reprocessed by machine
- Suitable for low-temperature procedure

ENDOCAM Logic HD camera head **85525902**

1-chip type, cable length 3 m

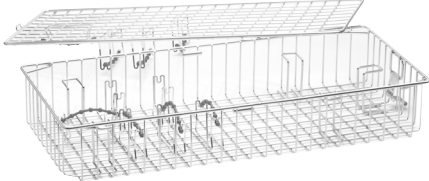
Recommended accessories	Product no.	
RIWO lens	C-Mount, f = 14 mm	85261144
	C-Mount, f = 24 mm	85261244
RIWO zoom lens	C-Mount, f = 13 - 29 mm	85261504
	Perforated basket for camera head (L x W x H) 448 x 200 x 73 mm	38002

VIII23 || Subject to modifications. Please note that some products may not be available in all countries. Please always take note of the information that is provided with the product. For more detailed information, please consult with your contact partner or directly with Richard Wolf GmbH.

ENDOCAM Logic HD

Technical data of camera head

Camera head		85525902
Device properties		
Sensor	1x1/3" CMOS	
Operation	2 programmable head buttons with 4 functions	
Operating conditions	+10°C to +30°C, 20% to 75% rel. humidity, atmospheric pressure 700 hPa to 1060 hPa	
Equipment		
Thread for objective lens	C-Mount	
Degree of protection against the ingress of moisture	IPX7	
Service	Cable and eyepiece snap-in coupling can be replaced on site	
Dimensions and weight		
Camera head weight (without cable)	95 g	
Housing dimensions (W x H) - without cable and anti-kink protection	34 x 36 mm	
Camera head length (without cable)	114 mm	
Cable length	3 m	
Cable outlet	30°	

System green

Camera head green

for the ICG/NIR Application

ENDOCAM



- Compatible with ENDOCAM Logic 4K und HD
- 2 programmable camera head buttons with 4 available functions
- Autoclavable camera head
- Use in ICG/NIR fluorescence endoscopy and in standard white light endoscopy

- Integrated lens
- Digital image processing and signal transmission
- Snap-on mechanism with locking function

ENDOCAM

Logic HD camera head green **85525812**

2-chip, cable length 3 m

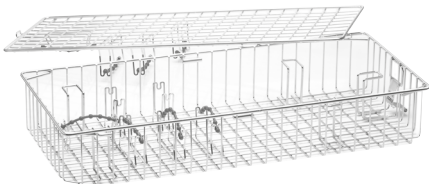
Recommended accessories	Product no.	
	<p>Perforated basket for camera head (L x W x H) 448 x 200 x 73 mm</p>	<p>38002</p>

V11123 || Subject to modifications. Please note that some products may not be available in all countries. Please always take note of the information that is provided with the product. For more detailed information, please consult with your contact partner or directly with Richard Wolf GmbH.

System green

Technical data camera head green

Camera head		85525812
Device properties		
Sensor	1/3" CMOS	
Operation	2 programmable head buttons with 4 functions	
Focal length range integrated lens	24 mm	
Operating conditions	+10°C to +30°C, 20% to 85% rel. humidity, atmospheric pressure 700 hPa to 1060 hPa	
Equipment		
Degree of protection against the ingress of moisture	IPX7	
Service	Cable and eyepiece snap-in coupling can be replaced on site	
Dimensions and weight		
Camera head weight (without cable)	196 g	
Housing dimensions (W x H) - without cable and anti-kink protection	48 x 48 x 136 mm	
Camera head length (without cable)	136 mm	
Cable length	3 m	
Cable outlet	30°	

System blue

Pendual camera head blue For photodynamic diagnostics (PDD)



- Suitable for ENDOCAM Logic 4K und HD Camera Controller
- Integrated filter for PDD applications
- Bendable housing for two application modes:
1: pivoting camera head, 2: straight camera head
- Freely rotating snap-on mechanism with lock function
- Integrated lens f = 15 mm

- Digital image processing and signal transmission
- 2 programmable camera head buttons with 4 available functions
- Camera head cable can be replaced in the hospital by technicians
- Can be reprocessed by machine
- Suitable for low-temperature procedure

ENDOCAM Logic HD

Pendual camera head blue **5525833**

1-chip type, cable length 3 m

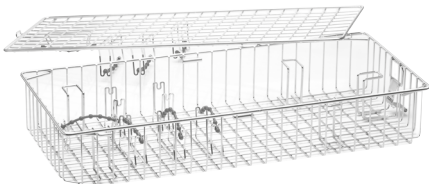
Recommended accessories	Product no.
	<p>Perforated basket for camera head (L x W x H) 448 x 200 x 73 mm</p> <p>38002</p>

System blue

Technical data of pendul camera head blue

Camera head		5525833
Device properties		
Sensor	1x 1/3" CMOS	
Operation	2 programmable head buttons with 4 functions	
Focal length range with integrated lens	15 mm	
Operating conditions	+10°C to +30°C, 30% to 75% rel. humidity, atmospheric pressure 700 hPa to 1060 hPa	
Equipment		
Degree of protection against the ingress of moisture	IPX7	
Service	Cable and eyepiece snap-in coupling can be replaced on site	
Handling	Pendulum housing can be converted into an axial camera head simply by rotating	
Dimensions and weight		
Camera head weight (without cable)	175 g	
Housing dimensions (W x H) - without cable and anti-kink protection	51 x 50 mm	
Camera head length (without cable)	141 mm	
Cable length	3 m	
Cable outlet	0°	

ENDOCAM Logic HD

Pendual camera head

ENDOCAM



- Bendable housing for two operating modes:
1: pivoting camera head, 2: straight camera head
- Freely rotating snap-on mechanism with lock function
- Integrated lens f = 14 mm
- Digital image processing and signal transmission
- 2 programmable camera head buttons with 4 available functions
- Camera head cable can be replaced in the hospital by technicians
- Can be reprocessed by machine
- Suitable for low-temperature procedure

ENDOCAM Logic HD pendual camera head 5525933

1-chip type, cable length 3 m

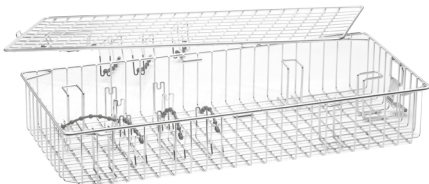
Recommended accessories	Product no.
	<p>Perforated basket for camera head (L x W x H) 448 x 200 x 73 mm</p> <p>38002</p>

VIII23 || Subject to modifications. Please note that some products may not be available in all countries. Please always take note of the information that is provided with the product. For more detailed information, please consult with your contact partner or directly with Richard Wolf GmbH.

ENDOCAM Logic HD

Technical data of pendul camera head

Camera head		5525933
Device properties		
Sensor	1x 1/3" CMOS	
Operation	2 programmable head buttons with 4 functions	
Focal length range with integrated lens	14 mm	
Operating conditions	+10°C to +30°C, 20% to 75% rel. humidity, atmospheric pressure 700 hPa to 1060 hPa	
Equipment		
Degree of protection against the ingress of moisture	IPX7	
Service	Cable and eyepiece snap-in coupling can be replaced on site	
Handling	Pendulum housing can be converted into an axial camera head simply by rotating	
Dimensions and weight		
Camera head weight (without cable)	170 g	
Housing dimensions (W x H) - without cable and anti-kink protection	51 x 50 mm	
Camera head length (without cable)	approx. 140 mm	
Cable length	3 m	
Cable outlet	0°	

ENDOCAM Logic HD lite

Camera controller

ENDOCAM
1



ENDOCAM Logic HD Lite camera controller

bndl **55252011**

Comprising:

- 1x ENDOCAM Logic HD Lite camera controller 5525201
- 1x hand-held remote control USB 5525401
- 1x USB flash memory 8GB 56540028
- 1x HDMI / DVI-D cable, lockable 3.0 m 103843
- 1x power cable 2440.03
- 1x 5525 DVD license open-source software 64360816

- Maximum quality at a minimum price
- Basic functions
- User-friendly

VIII23 || Subject to modifications. Please note that some products may not be available in all countries. Please always take note of the information that is provided with the product. For more detailed information, please consult with your contact partner or directly with Richard Wolf GmbH.

ENDOCAM Logic HD lite

Technical data of camera controller

Camera controller		5525201	
Device properties			
Type of controls	Mechanical button		
Max. video signal resolution	1920 x 1200 pixels		
White balance, color temperature range	2300K to 7000K		
Noise level	34 dB to 48 dB max.		
Digital zoom	1.5x max.		
Individually configurable profiles	at least 5 profiles		
Brightness control	Automatic shutter control + automatic gain control		
Image format of saved pictures / videos	JPEG, TIFF (max. 1920 x 1080)		
Operating conditions	+10°C to +40°C, 30% to 75% rel. humidity, atmospheric pressure 700 hPa to 1060 hPa		
Operating mode	Continuous operation		
Equipment			
IP rating	IP 20		
Cooling method	Controlled fan		
Power supply			
Mains + frequency	100 - 240 VAC, 50 / 60 Hz		
Power consumption	100 VA		
Current rating	max. 1.0 A		
Regulatory standards			
Safety	US/ CA: UL 2601-1 / CSA C22.2 NO.601.1, EU: EN 60601		
EMC	EN 60601-1-2 / IEC 601-1-2		
Medical device class	Class 1		
Classification of applied part	CF		
Interfaces			
Video outputs	2x HDMI		
Remote output	2 x 3.5 mm jack, stereo		
USB port (on front panel, for external storage media)	USB 2.0 (FAT32/NTFS formatting)		
Resolution (HDMI output)	Adjustable in the user menu 1280 x 1024/60P (5:4) 1920 x 1080/60P (16:9)		1920 x 1200/60P (16:10)
Dimensions and weights			
Weight	5.2 kg		
Dimensions (W x H x D)	300 x 120 x 416 mm		

ENDOCAM Logic HD

System overview

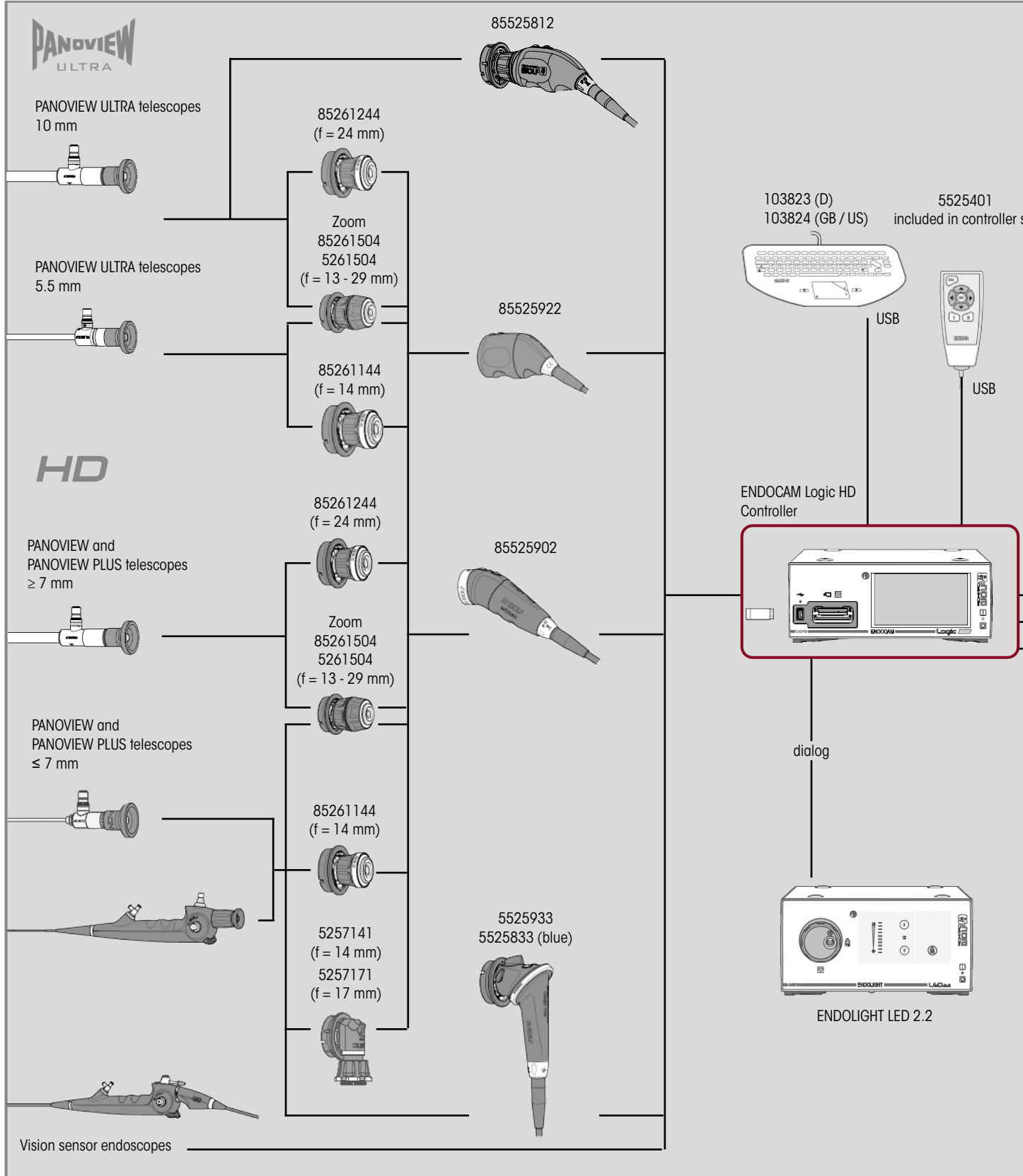

ENDOCAM
1

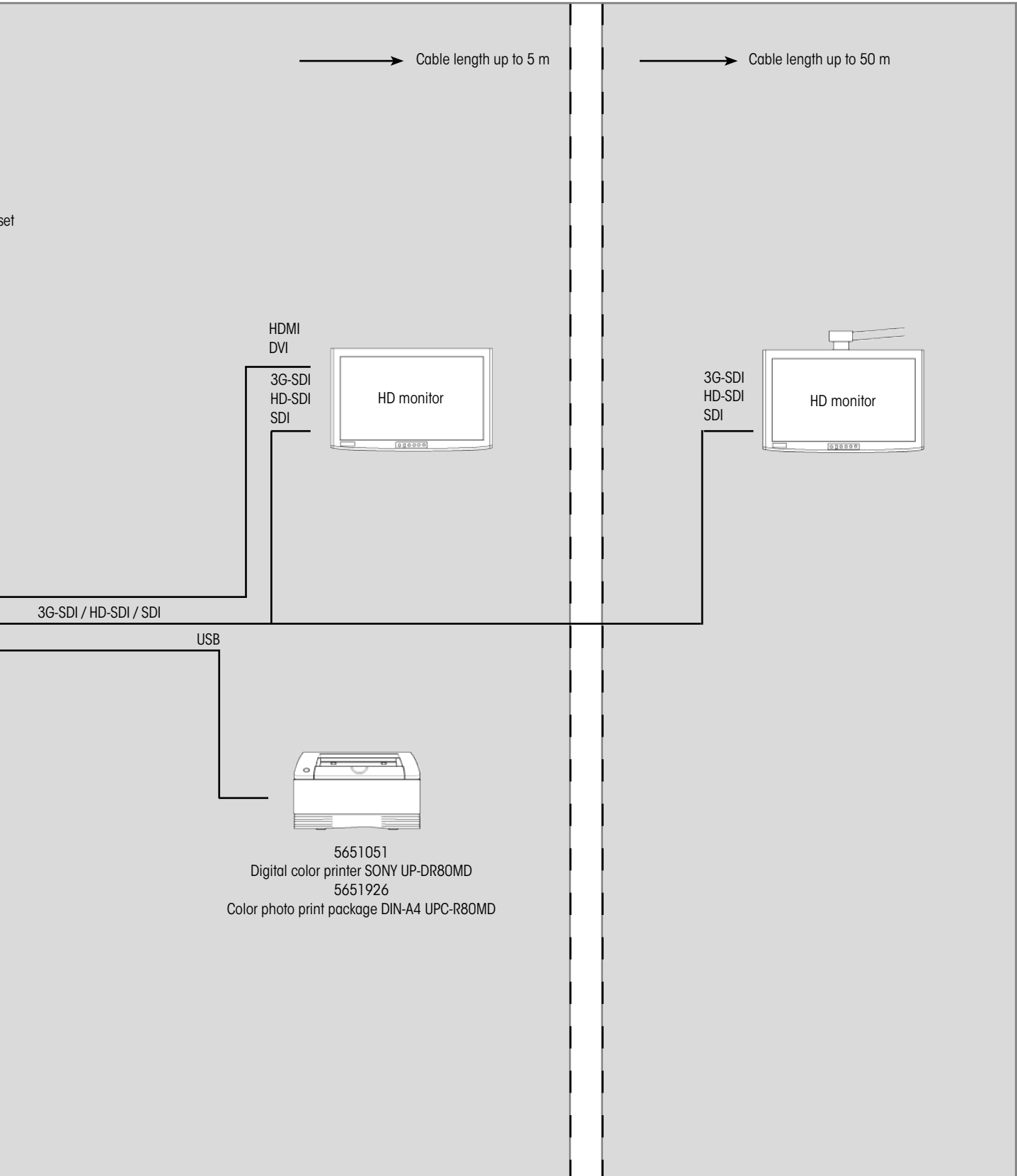

VIII23 || Subject to modifications. Please note that some products may not be available in all countries. Please always take note of the information that is provided with the product. For more detailed information, please consult with your contact partner or directly with Richard Wolf GmbH.



ENDOCAM Logic Camera controller comparison

Camera controller				
	ENDOCAM Logic HD		ENDOCAM Logic HD lite	ENDOCAM Logic 4K
				
	Product no.			
Properties	55251011	With 3G-SDI output 55251051 55251061	55252011	55253011
Saving of single images to USB memory stick (image archive)	•	•	•	•
Saving of videos to USB memory stick (video archive)	-	•	-	•
Entry of patient data via keyboard	•	•	•	•
Touchscreen	•	•	-	•
On-screen display	•	•	•	•
Compatible with core nova	•	•	•	•
Dialog function via Ethernet	•	•	•	•
Mirroring of images	•	•	-	•
4K signal processing	-	-	-	•
Special Imaging Modes	•	•	•	•
PDD functionality	•	•	-	•
ICG/NIR functionality	•	•	-	•
Connection of flexible endoscopes	•	•	•	•
Picture-in-picture input (only applies to 5525106 and 5525108)	-	•	-	•

ENDOCAM Flex HD

Camera controller



- Small design – low space requirement
- Attractive price-performance ratio
- For universal use in urology and pneumology with the new, flexible sensor endoscopes
- Optional camera head when using rigid endoscopes
- Adaptation of various C-Mount lenses

- Integrated VESA 100 interface for mounting to the wall or on the side of a device cart
- Optional: Bracket for adaptation to a monitor
 - Please note the ordering details of the recommended mounting accessories
- Documentation on PC / laptop possible via ENDOCAM Flex documentation software

ENDOCAM Flex HD camera controller

bndl 555211011

Comprising:

1x ENDOCAM Flex HD camera controller5521101
 1x HDMI/DVI-D cable, lockable, 3 m 103843
 1x power cable 2440.03

VIII23 || Subject to modifications. Please note that some products may not be available in all countries. Please always take note of the information that is provided with the product. For more detailed information, please consult with your contact partner or directly with Richard Wolf GmbH.

ENDOCAM Flex HD

Technical data of camera controller

Camera controller		5521101
Device properties		
Max. native video signal resolution	1920 x 1080 pixels	
White balance, color temperature range	2300 K to 7000 K	
Noise level	Noiseless, as no fan installed	
Digital zoom	1.5x max.	
Brightness control	Rolling shutter	
Operating conditions	+10°C to +40°C, 30% to 75% rel. humidity, atmospheric pressure 700 hPa to 1060 hPa	
Operating mode	Continuous operation	
Equipment		
IP rating	IP20	
Cooling method	Passive	
VESA mount	VESA 100 x 100 mm	
Power supply		
Mains + frequency	100-240 VAC, 50/60 Hz	
Power consumption	12 VA	
Current rating	0.1 - 0.05 A	
Regulatory standards		
Safety	US/ CA: UL 2601-1 / CSA C22.2 NO.601.1, EU: EN 60601	
EMC	EN 60601-1-2 / IEC 601-1-2	
Medical device class	Class 1	
Classification of applied part	BF	
Interfaces		
Video outputs	1x HDMI	
Resolution (HDMI output)	1920 x 1080 / 60p (16:9)	
USB port	USB 3.0	
Dimensions and weights		
Weight	1.5 kg	
Dimensions (W x H x D)	150 x 58 x 245 mm	

ENDOCAM Flex HD

Camera head

ENDOCAM
1



- Universally applicable in all endoscopic disciplines thanks to very high sensitivity
- C-Mount connection: universal application – even for easy adaptation to OR microscopes
- Small, weight-reduced camera head with two function buttons
- Ergonomic, stress-free handling
- Accurate color rendering thanks to sophisticated color calibration
- Can be reprocessed by machine
- Suitable for low-temperature procedure

ENDOCAM Flex HD camera head 5521902

1-chip type, C-Mount, cable length 2.5 m

Recommended accessories		Product no.
RIWO zoom lens	f = 13 - 29 mm	85261504
RIWO angled lens F 17mm	f = 17 mm	5257171

VIII23 || Subject to modifications. Please note that some products may not be available in all countries. Please always take note of the information that is provided with the product. For more detailed information, please consult with your contact partner or directly with Richard Wolf GmbH.

ENDOCAM Flex HD

Technical data of CCD camera head

ENDOCAM

Camera head		5521902
Device properties		
Sensor	1x 1/3" CMOS	
Operation	2 head buttons with preprogrammed functions	
Operating conditions	+10°C to +40°C, 30% to 75% rel. humidity, atmospheric pressure 700 hPa to 1060 hPa	
Equipment		
Thread for objective lens	C-Mount	
Degree of protection against the ingress of moisture	IPX7	
Service	Cable exchangeable	
Dimensions and weight		
Camera head weight (without cable)	125 g	
Housing dimensions (W x H) - without cable and anti-kink protection	34 x 34 mm	
Camera head length (without cable)	110 mm	
Cable length	2.5 m	
Cable outlet	30°	

VIII23 || Subject to modifications. Please note that some products may not be available in all countries. Please always take note of the information that is provided with the product. For more detailed information, please consult with your contact partner or directly with Richard Wolf GmbH.

ENDOCAM Flex HD

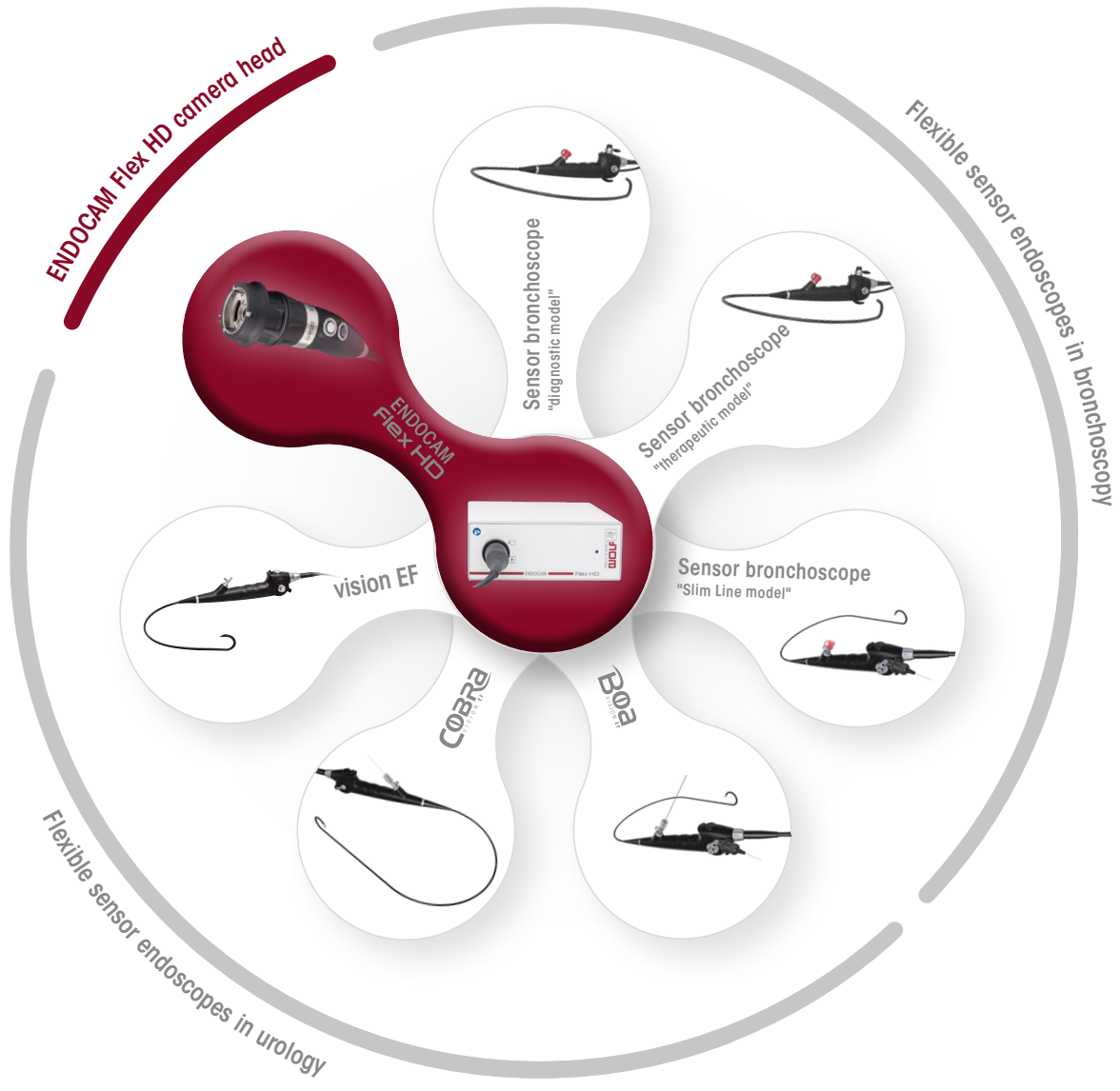

Compatible applied parts and camera head



- ENDOCAM Flex HD camera head, 1-chip (5521902)
- Flexible sensor ureterorenoscope "COBRA Vision EF" (73561071/076)
- Flexible sensor ureterorenoscope "BOA Vision EF" (73551071/076)
- Flexible sensor cystoscope "Vision EF" (73151001/006)
- Flexible sensor bronchoscope "diagnostic model" (7250001)
- Flexible sensor bronchoscope "therapeutic model" (7260001)
- Flexible sensor bronchoscope "Slim Line model" (7236001)

VIII23 || Subject to modifications. Please note that some products may not be available in all countries. Please always take note of the information that is provided with the product. For more detailed information, please consult with your contact partner or directly with Richard Wolf GmbH.

Overview of mounting solutions

Mounting solutions		Product no.
	<p>VESA 100 console for 1 device</p> <p>For mounting the ENDOCAM Flex controller to a pedestal, VESA 100, Dimensions: (W x H x D) 84 x 157.5 x 220 mm</p>	<p>5370401</p>
	<p>VESA 100 console for 2 devices</p> <p>For mounting the ENDOCAM Flex controller and ENDOCAM Flex LED to a pedestal, VESA 100, Dimensions: (W x H x D) 114 x 308 x 220 mm</p>	<p>5370402</p>
	<p>Device mount VESA 100</p> <p>For mounting the ENDOCAM Flex controller and/or ENDOCAM Flex LED on the side of the RIWomobil or other vertical mounting surfaces, Dimensions: (W x H x D) 190 x 138 x 100 mm</p>	<p>32116452</p>

ENDOCAM Flex HD

Documentation software

ENDOCAM
1

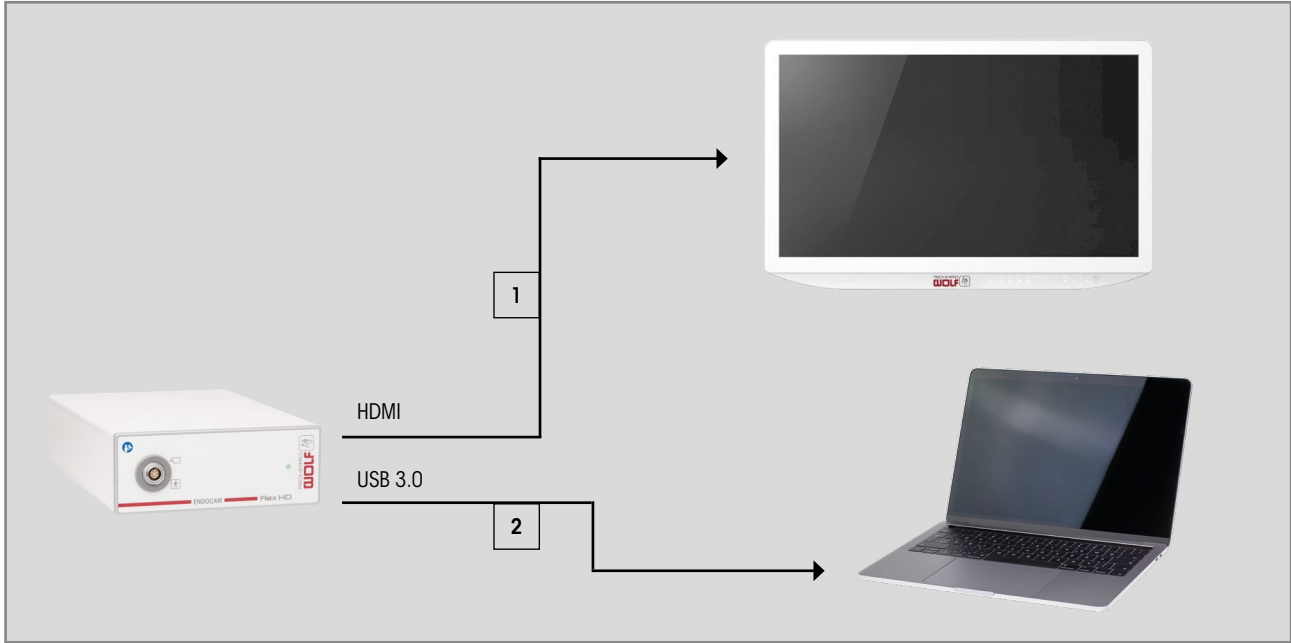

- Software for archiving data with the ENDOCAM Flex HD camera
 - Stores videos/images with patient information
 - Prints images
- Minimum hardware requirements:
Intel Core i5 - 2.4GHz CPU / 8GB RAM / USB-3 interface

- Recommended hardware requirements:
Intel Core i7 - 2.4GHz CPU / 8GB RAM / USB-3 interface
- The software supports the following operating systems:
Windows 7 / 8.1 / 10, 64-bit

Flex documentation software **5521201**
30-days demo version

Flex documentation software license **5521202**
for permanently using the Flex documentation software

Ultraflex USB 3.0 cable **4221-2.0M-UF**
USB cable, 3.0 compatible, high-speed capable,
USB type A to USB type B connector, length 2 m

VIII23 || Subject to modifications. Please note that some products may not be available in all countries. Please always take note of the information that is provided with the product. For more detailed information, please consult with your contact partner or directly with Richard Wolf GmbH.

ENDOCAM Flex HD

Overview

ENDOCAM Flex HD camera controller

bndl **55211011**

Comprising:

1x ENDOCAM Flex HD camera controller 5521101
 1x HDMI/DVI-D cable, lockable, 3 m 103843
 1x power cable 2440.03

ENDOCAM Flex HD camera head,

cable 2.5 m **5521902**

RIWO lenses, C-Mount

f = 14 mm **85261144**
 f = 24 mm **85261244**

Angular lenses, C-Mount

f = 14 mm **5257141**
 f = 17 mm **5257171**

RIWO zoom lens, C-Mount

f = 13 - 29 mm **5261504**

LIGHT SOURCE Flex LED bndl **51660011**

Comprising:

1x LIGHT SOURCE FLEX LED 42 W 5166001
 1x power cable 2440.03

Mounting solutions

VESA 100 console for 1 device 5370401
 VESA 100 console for 2 devices **5370402**
 Pedestal **53700190**
 Device mount VESA 100 **32116452**

Documentation

Flex documentation software **5521201**
 Flex documentation software license **5521202**
 Ultraflex USB 3.0 cable **4221-2.0M-UF**

HD LCD monitor

LCD MONITOR 21.5" **MDRAP21ELXACRW3**

Flexible applied parts for urology

Control lever in distal direction – articulation upward

Flexible sensor ureterorenoscope
 "BOA Vision EF" **735510761**
 "COBRA Vision EF" **735610761**
 Flexible sensor cystoscope "Vision EF" **731510061**

Control lever in distal direction – articulation downward

Flexible sensor ureterorenoscope
 "BOA Vision EF" **735510711**
 "COBRA Vision EF" **735610711**
 Flexible sensor cystoscope "Vision EF" **731510011**

Flexible applied parts for bronchoscopy

Flexible sensor bronchoscope "diagnostic model"
 Ø 5.2 mm, WL 600 mm **7250011**
 Flexible sensor bronchoscope "therapeutic model"
 Ø 6.2 mm, WL 600 mm **7260011**
 Flexible sensor bronchoscope "Slim Line model"
 Ø 2.9 mm, WL 680 mm **7236011**

ENDOCAM Epic 3DHD

Stereo camera controller incl. camera head



- Full HD dual 3-chip camera head for high-quality color rendering and HD image resolution
- Digital dual-link HD-SDI signal output for connecting professional 3DHD monitors
- Three dual-link signal outputs for flexible use with monitors, for 3D documentation or for video routing systems
- Digital signal processing

- Switching from 3D mode to 2D mode can be done directly on the controller
- Remote outputs for remote control (e.g. standby function of ENDOLIGHT light sources or controlling external color printers)
- Manual adjustment of measuring window to control imaging brightness
- White balance with memory function
- Automatic, electronic shutter control

ENDOCAM Epic 3DHD camera system

bndl 55310012

Comprising:

1x ENDOCAM Epic 3DHD camera system 5531001
 2x Coaxial cable vektor plus 2,00 m DZGR-0200-SW-GN
 1x Power cable 2440.03

Recommended accessories		Product no.
3D endoscope Ø 10 mm, WL 300 mm	0°	8934631
3D endoscope Ø 10 mm, WL 301 mm	30°	8934632
3D endoscope Ø 10 mm, WL 435 mm	0°	89344631
	30°	89344632
LCD monitor		LMD-3251MT

ENDOCAM Epic 3DHD System overview

1 ENDOCAM

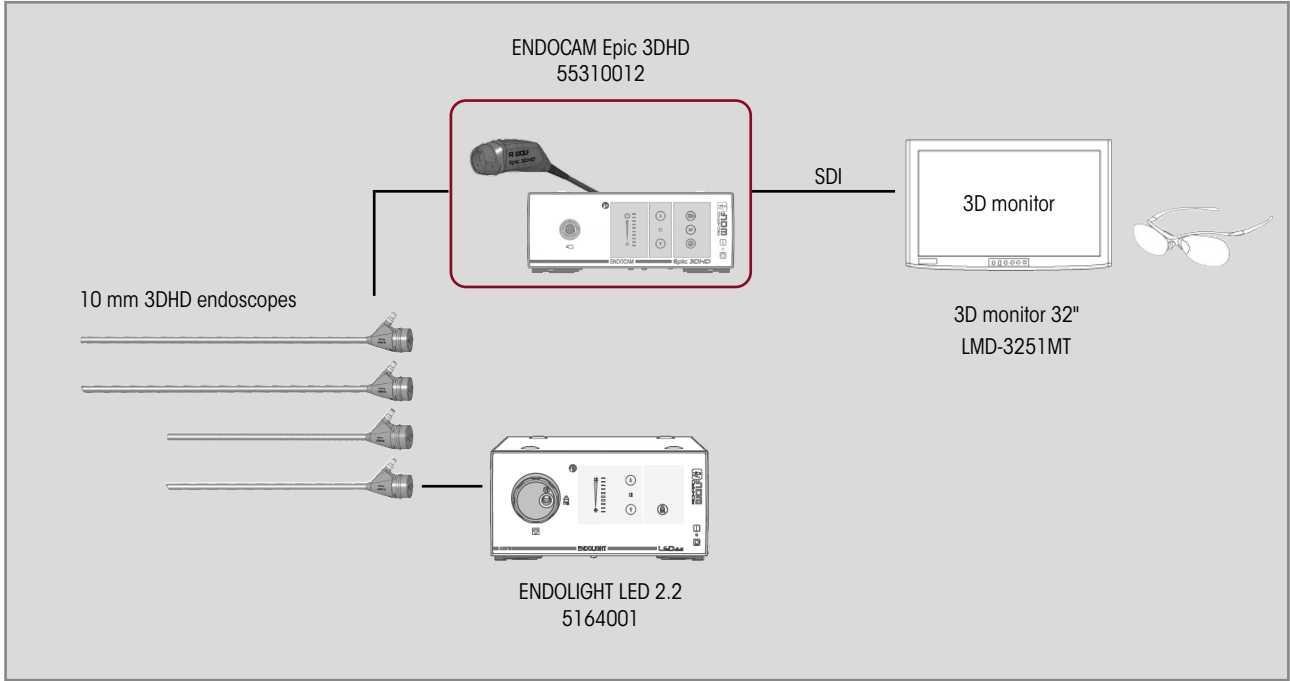

VIII23 || Subject to modifications. Please note that some products may not be available in all countries. Please always take note of the information that is provided with the product. For more detailed information, please consult with your contact partner or directly with Richard Wolf GmbH.

ENDOCAM Epic 3DHD

Technical data of camera controller

Camera controller		5531001
Device properties		
Type of controls	mech. buttons	
Max. video signal resolution	1920 x 1080 pixels	
White balance, color temperature range	2300 K to 7000 K	
Noise level	Noiseless, as no fan installed	
Brightness control	Automatic shutter control	
Operating conditions	+ 10°C to + 30°C , 30% to 75% rel. humidity, atmospheric pressure 700 hPa to 1060 hPa	
Operating mode	Continuous operation	
Equipment		
IP rating	IP20	
Cooling method	Passive	
Power supply		
Mains + frequency	100-240 VAC, 50/60 Hz	
Power consumption	40 VA	
Current rating	max. 0.6 A	
Regulatory standards		
Safety	US/ CA: UL 2601-1 / CSA C22.2 NO.601.1, EU: EN 60601	
EMC	EN 60601-1-2 / IEC 601-1-2	
Medical device class	Class 1	
Classification of applied part	CF	
Interfaces		
Video outputs	3x dual HD-SDI (6x BNC)	
Remote output	2 x 3.5 mm jack, stereo	
Resolution (HD-SDI output)	2x 1920 x 1080i (50Hz)	
Dimensions and weights		
Weight	6.8 kg	
Dimensions (W x H x D)	300 x 120 x 416 mm	

ENDOCAM Epic 3DHD

Technical data of CCD camera head

Camera head	
Device properties	
Operating conditions	+ 10°C to + 30°C , 30% to 75% rel. humidity, atmospheric pressure 700 hPa to 1060 hPa
Dimensions and weight	
Camera head weight (without cable)	390 g
Housing dimensions (W x H) - without cable and anti-kink protection	55 x 60 cm
length	140 mm
Length of camera cable	3.8 m
Cable outlet	30°

WIRELESS IMAGING SYSTEM

System for wireless signal transmission in 4K quality

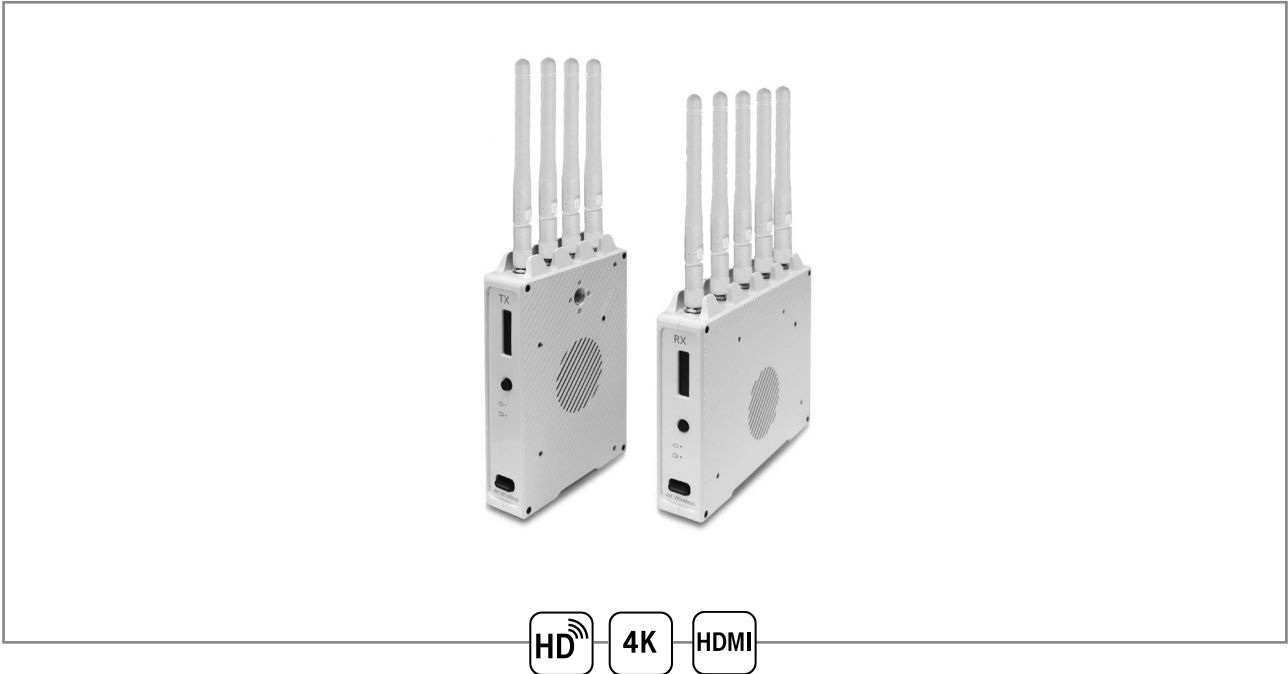

- For wireless signal transmission up to 4K
- Excellent transmission even when there is no direct visual contact
- Ideal for second monitors which are positioned flexibly
- Easy to install behind monitors using matching mounting plates
- Increased efficiency and safety by eliminating cumbersome cables, which are potential trip hazards
- Coupling preset as standard at the factory
- Supplied as a set including mounting plates, power supply units, and cables

Wireless imaging system **WUH4060**

System for wireless signal transmission in 4K quality

WIRELESS IMAGING SYSTEM

Technical data

Wireless imaging system		WUH4060
Frequency band	GHz	
Video input	Transmitter: 1x HDMI, 1x 12G-SDI	
Video output	Transmitter: 1x 12G-SDI loop through Receiver: 1x HDMI, 2x 12G-SDI	
Video resolution	4Kp 23.98/24/25/29.97/30/50/59.94/60 1080p 23.98/24/25/29.97/30/50/59.94/60 1080PsF 23.98/24/25/29.97/30 1080i 50/59.94/60 720p 50/59.94/60 480p 59.94/576p50	
Range	Up to approx. 30 m	
Latency	Close to zero (< 1 ms)	
Hardware encryption	256-bit AES	
Power connection	12 V/3 A DC // TX power: 20 W, RX power: 18 W	
Safety	FCC CFR 47 Part 15 Subpart E Class B Part 15 Subpart B Class A FCC ID TX: VQSAMN41012 RX: VQSAMN42012 IC ID TX: 7680A-AMN41012 RX: 7680A-AMN42012	CE EMC EN 55011:209 +A1:2010 EN 60601-1-2:2015 EN 61000-3-2:2014 EN 61000-3-3:2013 EN 301-489-1 V2.1.1 EN 301-893 V2.1.1 EN 62311 CE (RED) EN 300-328 V2.1.1 VCCI VCCI-CISPR 32:2016
Dimensions (W x H x D)	Transmitter: 132 x 91 x 27 mm Receiver: 112 x 139 x 27 mm	
Weight	Transmitter: 360 g Receiver: 434 g	

Accessories Signal cable

3G-SDI BNC cable				
	Vector Plus coax cable	1 m	DZGR-0100-SW-GN	
		2 m	DZGR-0200-SW-GN	
		3 m	DZGR-0300-SW-GN	
		15 m	DZGR-1500-SW-GN	
		25 m	DZGR-2500-SW-GN	
Accessories for cabling assembly				
	Vector Plus PUR coax cable	50 m	600-0211	
	BNC-HDTV rear twist		NBNC75BWU13	
	Crimp pliers For assembling BNC cables. Matching connector NBNC75BWU13		723231329	
	Crimp insert		723231330	
HDMI & DVI-D cable				
	DVI-D cable 18+1 (m) / 18+1 (m)	3 m	103.830	
	HDMI/DVI-D cable, lockable	3 m	103843	
	HDMI / HDMI cable lockable	3 m	103847	
	HDMI / HDMI cable	0.5 m	HDMI-MM-0.5MG-UF	





Accessories

Power cable - other cables

Power supply		Product no.		
	Adapter cable 12 VDC power supply for ENDOCAM Logic HD			103806
	Cable power supply CAN-BUS			643211527
Device connection cables				
	Device connection cable	0.6 m		32114.321
		3 m		100-201-0583
	Device connection cable	0.9 m		31100.922
	Device connection cable	3 m		32114.323
Potential equalization				
	POAG device cable Ø 4 mm	0.8 m		32114.311
	POAG supply line Ø 6 mm	6 m		32114.315
Interface cables				
	Remote control cable 3.5 mm / 3.5 mm (stereo)	1.5 m		5502.991
	Remote control cable 1x RS 232 to 9-pin DSUB plug, 2x 3.5 mm	2.0 m		5595.991
	Ultraflex USB 3.0 cable USB type A to USB type B connector	2.0 m		4221-2.0M-UF

Accessories

Power cable - other cables

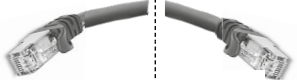
CAN bus				
		CAN bus connection cable 2x SUB-D 9-pin (m)	0.4 m	103.701
		CAN bus terminator		5590.989
Serial data cable				
		ST/BU 9-pin D-SUB	10 m	72325.361
		ST/BU 9-pin D-SUB	1 m	72325380
Ethernet cable				
		Patch cable, RJ45 SFTP	0.5 m	72325378
		Patch cable, RJ45 HRS TM11	1 m	72325429
		Ethernet cable, RJ45 S/FTP CAT.6	2 m	103.03
		Ethernet cable	5 m	72325.328
		Patch cable, RJ45 S/FTP CAT.6	10 m	72325434
		Patch cable, RJ45 S/FTP CAT.6	20 m	72325435
		S h i e l d e d twisted-pair cable	0.9 m	XTP DTP 24/3
			7.6 m	XTP DTP 24/25
			22.4	XTP DTP 24/75
			30.4	XTP DTP 24/100

Accessories

Keyboards - storage media

Keyboards	Product no.	
	Mini CleanBoard USB German version (QWERTZ)	103823
	Mini CleanBoard USB US / English version (QWERTY)	103824

■ **Keyboards**

Wipe-clean USB keyboard incl. mouse pad. Magnets integrated on the underside for reliable surface contact. IP65 splash-water protected, suitable for common disinfectants.

Dimensions (W x H x D): 300 x 22.4 x 180 mm

USB flash memory	Product no.	
	USB flash memory 8 GB Formatting: FAT32	56540028
	USB flash memory 32 GB	72321829

RIWO lenses

RIWO zoom lens with snap-on mechanism and C-Mount thread, steam-sterilizable and reprocessable by machine

Product no.



AUTOCLAVE
134° C / 273° F

RIWO zoom lens
f = 21 - 36 mm

85261.501

RIWO zoom lens with snap-on mechanism and C-Mount thread, steam-sterilizable and reprocessable by machine



AUTOCLAVE
134° C / 273° F

RIWO zoom lens
f = 13 - 29 mm

85261504

RIWO zoom lens with snap-on mechanism and C-Mount thread, reprocessable by machine and suitable for low-temperature procedure



RIWO zoom lens
f = 13 - 29 mm

5261504

RIWO lens with snap-on mechanism and C-Mount thread, steam-sterilizable and reprocessable by machine



AUTOCLAVE
134° C / 273° F

RIWO lens
f = 14 mm

85261144

RIWO lens
f = 24 mm

85261244

RIWO lens with snap-on mechanism and C-Mount thread, steam-sterilizable and reprocessable by machine



AUTOCLAVE
134° C / 273° F

RIWO lens
f = 27 mm





85261.272

RIWO lens
f = 32 mm

85261.322

RIWO lenses / adapters

Lenses
3

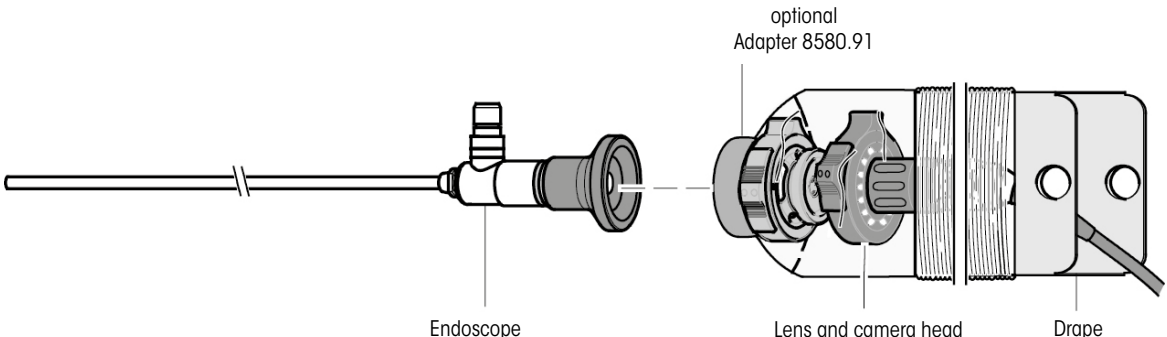
RIWO angular lens with rotatable snap-on mechanism and C-Mount thread, suitable for reprocessing by machine and low-temperature procedure		Product no.
	<p>RIWO angled lens beam splitter F 27mm beam splitter 10% eye, 90% camera, f = 27 mm</p>	5257.271
RIWO angular lens with rotatable snap-on mechanism and C-Mount thread and suspension function, suitable for reprocessing by machine and low-temperature procedure		
	<p>f = 14 mm for ENDOCAM 5525 f = 17 mm for ENDOCAM 5521</p> <p>RIWO angled lens F 14mm f = 14 mm, image format 16:9 / 16:10</p>	5257141
	<p>RIWO angled lens F 17mm f = 17 mm, image format 4:3 / 5:4</p>	5257171
Connection of C-Mount lenses to endoscopes (telescopes) with plug-on connection		
	Sterile adapter	8580.91
	Plug-on eyecup	8885.901
 <p style="text-align: center;">optional Adapter 8580.91</p> <p style="text-align: center;">Endoscope Lens and camera head Drape</p>		

VIII23 || Subject to modifications. Please note that some products may not be available in all countries. Please always take note of the information that is provided with the product. For more detailed information, please consult with your contact partner or directly with Richard Wolf GmbH.

Medical LCD monitor 4K 55"



- OptiContrast Panel™ (IPS) with 520 cd/m² and 1400:1 contrast
- Slim housing with narrow edge for optimum use of screen surface
- Outstanding image quality even when displaying zoomed images
- Optimized presets for Richard Wolf

LCD monitor 4K 55" **LMD-X550NB**

Accessories		Product no.
Monitor cart (trolley)		32116000
Monitor mounting bracket VESA 200 x 400		32116472
Balancing module for RIWomobil without electrical equipment		32116458
Balancing module for RIWomobil with baseline electrics		32116459
RIWomobil device cart		
RIWomobil device cart with baseline electrics and reinforced bridge	100-120 VAC	32116012
	220-240 VAC	32116014
RIWomobil device cart with premium-line electrics and reinforced bridge	100-120 VAC	32116013
	220-230 VAC	32116015
Protective cover		
Protective cover for 55" monitor		53700055

LCD monitor 4K 55"

Technical data

LCD monitor 4K 55"		LMD-X550NB	
Device properties			
Screen diagonal	55"		
Resolution / aspect ratio	3840 x 2160 pixels / 16:9		
Background lighting	LED		
Panel technology	IPS		
Display colors	1,073,000,000		
Contrast	1400 : 1		
Max. luminance	620 cd/m ²		
Response time	20 ms		
Angle of view	178° H / 178° V		
Equipment			
Video input / output	4K in: 1x HDMI or 4x BNC (3G-SDI) out: 4x BNC	HD: in: 5x BNC (3G-/HD-/SD-SDI), 1x DVI-D out: 5x BNC (3G-/HD-/SD-SDI), 1x DVI-D	
VESA mount	VESA 200 x 200 VESA 300 x 300		
IP rating	IPX2		
Power supply			
Mains + frequency	100 - 240 VAC, 50/60 Hz		
Power consumption	290 VA		
Current rating	2.1 - 1.0 A		
Power supply	Internal power supply unit		
Regulatory standards			
Safety	US/CA: UL 60601-1, CAN/CSA-C22.2 No. 60601-1, EU: EN 60601-1		
EMC	US/CA: FCC Part 15 Class A, ICES-003 Class A, EU: EN 60601-1-2, AU: EN 55011 Class B, J: VCCA Class A"		
CB certification	IEC 60601-1, IEC 60065		
Medical device class	MDD (EU): Class I Medical Device FD&C Act FDA: Class II Medical Device		
Dimensions and weight			
Weight	35.2 kg		
Dimensions (W x H x D)	1264.6 x 771.5 x 85.5 mm		

Medical LCD monitor 4K 43"

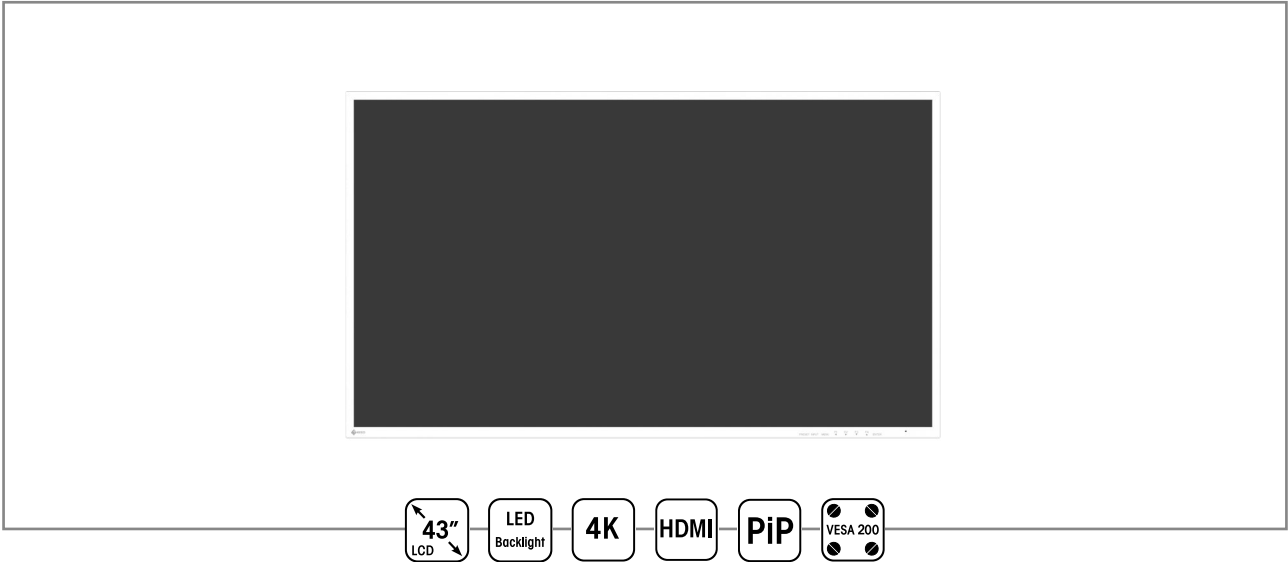

- IPS panel with 700 cd/m² and 1,000:1 contrast
- Slim housing with narrow edge for optimum use of screen surface
- Outstanding image quality even when displaying zoomed images
- Excellent compatibility and future-proofing thanks to numerous inputs and outputs

- Power supply unit supplied with the monitor provides indirect power supply
- Attention: Power cables are not included in the scope of delivery and must be ordered separately

CURATOR EX4342 **6GF62008UA01**

Accessories		Product no.
Monitor cart		32116000
Monitor mounting bracket VESA 200 x 400		32116472
Balancing module for RIWomobil without electrical equipment		32116458
Balancing module for RIWomobil with base line electrics		32116459
Power cable, 3 m long		2440.03
RIWomobil device cart		
RIWomobil device cart with base line electrics and reinforced bridge	100–120 V~	32116012
	220–240 V~	32116014
RIWomobil device cart with premium-line electrics and reinforced bridge	100–120 V~	32116013
	220–230 V~	32116015
Protective cover		
Protective cover for 55" monitor		53700055

LCD monitor 4K 43"

Technical data

CURATOR EX4342		6GF62008UA01	
Device properties			
Screen diagonal	43"		
Resolution / aspect ratio	3,840 x 2,160 pixels / 16:9		
Background lighting	LED		
Panel technology	IPS		
Display colors	1,073,000,000		
Contrast	1,000:1		
Max. luminance	700 cd/m ²		
Response time	8 ms		
Angle of view	178° H / 178° V		
Equipment			
Video input/output	4K in: 1x HDMI, 1x DisplayPort 1.2, 1x 12G-SDI, out: 1x 12G-SDI loop, 1x DisplayPort 1.2 loop		HD in: 1x 3G-SDI, 1x DVI-D out: 1x DVI-D
VESA mount	VESA 400 x 200		
IP rating	IP45 front, IP32 rear		
Power supply			
Power connection + frequency	AC power supply unit: 100–240 V~, 50/60 Hz		
Power consumption	144 VA		
Current rating	Monitor: 48 VDC, 3.0 A		
Power supply unit	External power supply unit		
Regulatory standards			
Safety and certifications	CE (medical device), EN 60601-1, ANSI/AAMI ES60601-1, CSA C22.2 No. 601-1, IEC 60601-1, VCCI-A, FCC-A, CAN ICES-3(A), RCM, RoHS, China RoHS, WEEE, CCC		
EMC	EN 60601-1, ANSI/AAMI ES60601-1, CSA C22.2 No. 601-1, VCCI-A, FCC-A, CAN ICES-3(A)		
CB certification	IEC 60601-1		
Medical device class	MDR (EU): Class I Medical Device FD&C Act FDA: Class II Medical Device		
Dimensions and weight			
Weight	17 kg		
Dimensions (W x H x D)	974 x 567 x 79 mm		

Medical LCD monitor 4K 32"



- TFT Active Matrix LCD
- Very bright panel with 500 cd/m² and 1000:1 contrast
- Slim housing with narrow edge for optimum use of screen surface
- Direct power supply or optionally via an external power supply unit
- Optimized color matching for Richard Wolf ENDOCAM
- Automatic switching to second monitor input if the connection to input 1 is interrupted

LCD monitor **LMD-X3200N**

Recommended accessories		Product no.
FLEXION-PORT 400 (68cm) bndI	Swivel arm Mounting on the side in the aluminum profile	321160681
FLEXION-PORT 350+300 (93cm) bndI		321160931
FLEXION-PORT 400 (68cm) bndI	Swivel arm Mounting on the reinforced monitor bridge	321160682
FLEXION-PORT 350+300 (93cm) bndI		321160932
Monitor mount VESA 75/100		321165001
Monitor stand		SU-600MD
External power supply unit AC adapter for LCD monitor 4K 31"		AC-300MD
For extending the power supply unit on the secondary end		
Vector Plus coax cable 50,00m PUR		600-0211
Neutrik XLR 3 pole female cable connecto		NC3FXX
Neutrik XLR 3-pin plug		NC3MXX

LCD monitor 4K 32"

Technical data

LCD monitor		LMD-X3200N	
Device properties			
Screen diagonal	32"		
Resolution / aspect ratio	3,840 x 2,160 pixels / 16:9		
Background lighting	LED		
Panel technology	IPS		
Display colors	1,073,000,000		
Contrast	1000:1		
Max. luminance	500 cd/m ²		
Response time	2.5 ms (HD), 3.5 ms (4K)		
Angle of view	178° H / 178° V		
Equipment			
Video input / output	4K in: 1x HDMI, 1x BNC (12G-SDI), 1x display port out: 1x BNC (12G-SDI)		HD: in: 1x BNC (3G-/HD-/SD-SDI), 1x DVI-D out: 2x BNC (1x 3G-SDI, 1x clone)
VESA mount	VESA 100 x 100		
IP rating	Protection against water ingress: no special protection		
Power supply			
Mains + frequency	100–240 V~, 50/60 Hz		
Power consumption	163 VA		
Current rating	1.7–0.8 A		
Power supply unit	Either internal or external power supply unit		
Regulatory standards			
Safety	US: UL (ANSI/AAMI ES60601-1), CA: cUL (CAN/CSA-C22.2 (No. 60601-1)), EU: CE (MDR) (EN 60601-1 + 60601-1-2)		
EMC	US: FCC (Class A Digital Device), CA: ISED (ISED Class A Digital Device), EU: EN 60601-1-2		
CB certification	IEC 60065, IEC 60950-1, IEC 60601-1		
Medical device class	Class I Medical Device FD&C Act: Class I		
Dimensions and weight			
Weight	11.8 kg		
Dimensions (W x H x D)	754 x 476 x 79 mm		
External power supply unit weight	1.5 kg		
External power supply unit dimensions (W x H x D)	245 x 150 x 58 mm / cable length between monitor and power supply unit: 2.8 m		

Medical LCD monitor 4K 31"



- α-Si TFT Active Matrix LCD
- Very bright OptiContrast Panel™ (IPS) with 770 cd/m² and 1450:1 contrast
- Slim housing with narrow edge for optimum use of screen surface
- Outstanding image quality even when displaying zoomed images
- Optimized presets for Richard Wolf
- External power supply unit

LCD monitor 4K 31" LMD-X310NB

Recommended accessories		Product no.
FLEXION-PORT 400 (68 cm) bndl	Swivel arm Mounting on the side in the aluminum profile	321160681
FLEXION-PORT 350+300 (93 cm) bndl		321160931
FLEXION-PORT 400 (68 cm) bndl	Swivel arm Mounting on the reinforced monitor bridge	321160682
FLEXION-PORT 350+300 (93 cm) bndl		321160932
Monitor mounting bracket VESA 75 x 100		321165001
Monitor stand		SU-600MD
External power supply unit AC adapter for LCD monitor 4K 31"		AC-300MD
For extending the power supply unit on the secondary end		
Vector Plus PUR coax cable (50 m)		600-0211
Neutrik XLR 3-pin socket		NC3FXX
Neutrik XLR 3-pin plug		NC3MXX
Protective cover		
Protective cover for 31" monitor		53700031

LCD monitor 4K 31"

Technical data

LCD monitor 4K 31"		LMD-X310NB	
Device properties			
Screen diagonal	31"		
Resolution / aspect ratio	4096 x 2160 pixels / 17:9		
Background lighting	LED		
Panel technology	IPS		
Display colors	1,073,000,000		
Contrast	1450:1		
Max. luminance	770 cd/m ²		
Response time	20 ms		
Angle of view	178° H / 178° V		
Equipment			
Video input / output	4K in: 1x HDMI or 4x BNC (3G-SDI) out: 4x BNC	HD: in: 5x BNC (3G-/HD-/SD-SDI), 1x DVI-D out: 5x BNC (3G-/HD-/SD-SDI), 1x DVI-D	
VESA mount	VESA 100 x 100 VESA 200 x 200		
IP rating	IPX2		
Power supply			
Mains + frequency	100 - 240 VAC, 50/60 Hz		
Power consumption	180 VA		
Current rating	2.1 - 1.0 A		
Power supply	External power supply unit		
Regulatory standards			
Safety	US/CA: UL 60601-1, CAN/CSA-C22.2 No. 60601-1, EU: EN 60601-1		
EMC	US/CA: FCC Part 15 Class A, ICES-003 Class A, EU: EN 60601-1-2, AU: EN 55011 Class B, J: VCCA Class A"		
CB certification	IEC 60601-1, IEC 60065		
Medical device class	MDD (EU): Class I Medical Device FD&C Act FDA: Class II Medical Device		
Dimensions and weight			
Weight	11.8 kg		
Dimensions (W x H x D)	754 x 456 x 69 mm		
External power supply unit weight	1.5 kg		
External power supply unit dimensions (W x H x D)	245 x 150 x 58 mm / cable length between monitor and power supply unit: 2.8 m		

Medical LCD monitor 27" 4K



- Very bright panel with 800 cd/m² and 1000:1 contrast
- 4K resolution with 3840 x 2160 pixels
- Slim housing with narrow edge for optimum use of the display
- Direct power supply or optionally via an external power supply unit
- Optimized color matching for Richard Wolf ENDOCAM
- Automatic switching to second monitor input if the connection to input 1 is interrupted

LCD monitor 27" 4K LMD-X2705N

Recommended accessories		Product no.
FLEXION-PORT 300 (58 cm) bndl	Swivel arm Mounting on the side in the aluminum profile	321160581
FLEXION-PORT 350+400 (103 cm) bndl		321161031
FLEXION-PORT 400 (68 cm) bndl		321160681
FLEXION-PORT 350+300 (93 cm) bndl		321160931
FLEXION-PORT 300 (58 cm) bndl	Swivel arm Mounting on the reinforced monitor bridge	321160582
FLEXION-PORT 350+400 (103 cm) bndl		321161032
FLEXION-PORT 400 (68 cm) bndl		321160682
FLEXION-PORT 350+300 (93 cm) bndl		321160932
Monitor mount VESA 75/100		321165001
Monitor stand		SU-600MD
External power supply unit AC adapter for LCD monitor 4K 31"		AC-300MD
For extending the power supply unit on the secondary end		
Vector Plus PUR coax cable 50,00m PUR		600-0211
Neutrik XLR 3 pole female cable connector		NC3FXX
Neutrik XLR 3 pole male cable connector		NC3MXX
Protective cover		
Protective cover for monitor 27"		53700027

LCD monitor 27" 4K

Technical data

LCD monitor 27" 4K		LMD-X2705N	
Device properties			
Screen diagonal	27"		
Resolution / aspect ratio	3840 x 2160 / 16:9		
Background lighting	LED		
Display colors	1.073.000.000		
Contrast	1000:1		
Max. luminance	800 cd/m ²		
Response time	4 ms		
Angle of view	178° H / 178° V		
Equipment			
Video input / output (SD)	In: 1x HDMI 2.0b, 1x DVI-D, 1x 3G/HD/SD-SDI, 2x display port Out: 1x DVI-D, 1x 3G/HD/SD-SDI, 1x display port		
VESA mount	VESA 100 x 100		
IP rating	IPX5 (front), IPX2 (all other sides)		
Power supply			
Mains + frequency	100 - 240 VAC, 50/60 Hz		
Power consumption	149 VA		
Current rating	1.5 to 0.7 A		
Power supply unit	Internal power supply unit		
Regulatory standards			
Safety	US: UL (ANSI_AAMI ES60601-1, FCC (Class A Digital Device) Canada: cUL (Can/CSA-C22.2 (No. 60601-1)), ISED (ISED Class A Digital Device) EU: CE (MDD) (EN 60601-1 + EN60601-1-2)		
CB certification	IEC60065, IEC 62368-1, IEC60601-1		
Medical device class	MDD (EU): Class I Medical Device; FD&C Act FDA: Class II Medical Device		
Dimensions and weight			
Weight	8.8 kg		
Dimensions (W x H x D)	658.8 x 426.8 x 80 mm		

Medical FHD monitor 21.5"



- Compact Full HD widescreen LCD with 21.5" screen diagonal
- Ideal for use as second viewing monitor or in combination with sensor endoscopes
- Optimized color matching for Richard Wolf ENDOCAM
- Excellent color rendering
- VESA mount for ergonomic fastening to swivel arms

FHD monitor 21.5"..... **FS-E2101D**

Recommended accessories		Product no.
FLEXION-PORT 300 (58 cm) bundle	Swivel arm Mounting on the side in the aluminum profile	321160581
FLEXION-PORT 350+400 (103 cm) bundle		321161031
FLEXION-PORT 300 (58 cm) bundle	Swivel arm Mounting on the reinforced monitor bridge	321160582
FLEXION-PORT 350+400 (103 cm) bundle		321161032
Monitor mounting bracket VESA 75/100		321165001

VII23 || Subject to modifications. Please note that some products may not be available in all countries. Please always take note of the information that is provided with the product. For more detailed information, please consult with your contact partner or directly with Richard Wolf GmbH.

FHD monitor 21.5"

Technical data

FHD monitor 21.5"		FS-E2101D
Device properties		
Screen diagonal	21.5"	
Resolution / aspect ratio	1,920 x 1,080 pixels / 16:9	
Background lighting	LED	
Display colors	16,700,000	
Contrast	1,000:1	
Max. luminance	400 cd/m ²	
Response time	22 ms	
Angle of view	178° H / 178° V	
Equipment		
Video input / output (SD)	in: 1x DVI-D, 1x VGA, 1x 3G-SDI out: 1x 3G-SDI	
VESA mount	VESA 100 x 100	
IP rating	IP33	
Power supply		
Power connection + frequency	100–240 V~	
Power consumption	40 VA	
Power supply unit	External power supply unit	
Regulatory standards		
Safety	US: ANSI/AAMI ES60601-1 (UL 60601-1), CA: CAN/CSA C22.2 No. 60601-1	
Medical device class	MDD (EU): Class I Medical Device	
EMC	US: FCC Class B, EN 60601-1, EU: EN 60601-1-2	
Dimensions and weight		
Weight	5.6 kg	
Dimensions (W x H x D)	528 x 335 x 58 mm	

Medical LCD monitor 21.5"



- HDTV-capable compact widescreen LCD with 21.5" screen diagonal
 - Preferably used as a second observation monitor or in combination with ENDOCAM Performance HD / ENDOCAM Flex HD
- Excellent color rendering
 - VESA mount for ergonomic fastening to swivel arms

LCD monitor 21.5" MDRAP21ELXACRW3

Recommended accessories	Product no.
Stand base - monitor stand	OP-MED-TF-R9016

VIII23 || Subject to modifications. Please note that some products may not be available in all countries. Please always take note of the information that is provided with the product. For more detailed information, please consult with your contact partner or directly with Richard Wolf GmbH.

LCD monitor 21.5"

Technical data

LCD monitor 21.5"		MDRAP21ELXACRW3
Device properties		
Screen diagonal	21.5"	
Resolution / aspect ratio	1920 x 1080 pixels / 16:9	
Background lighting	LED	
Display colors	16,700,000	
Contrast	1000:1	
Max. luminance	250 cd/m ²	
Response time	14 ms	
Angle of view	178° H / 178° V	
Equipment		
Video input / output (SD)	in: 1x DVI-I, 1x VGA, 1x display port	
Signal inputs	1x VGA (HD 15)	
VESA mount	VESA 100 x 100	
IP rating	IPX1	
Power supply		
Mains + frequency	100 - 250 VAC, 50/60 Hz	
Power consumption	85 VA	
Power supply	External power supply unit	
Regulatory standards		
Safety	EU: EN 60601-1	
Medical device class	MDD (EU): Class I Medical Device	
Dimensions and weight		
Weight	5.7 kg	
Dimensions (W x H x D)	537 x 384 x 236 mm	

Medical LCD monitor 19"

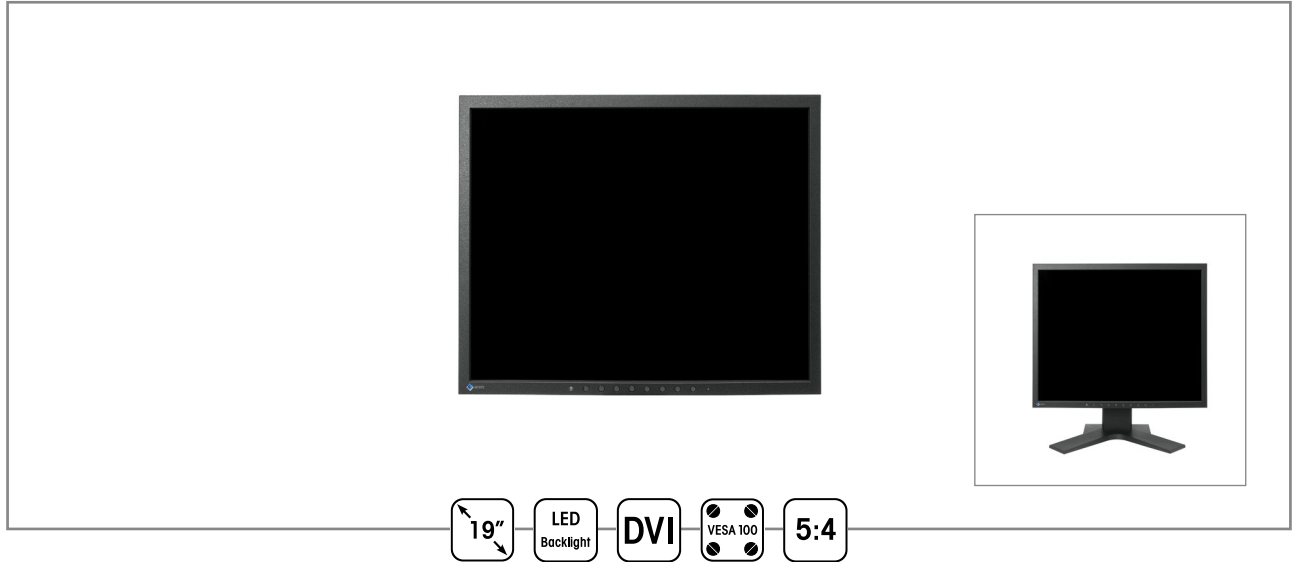

- Very bright panel with 700 cd/m² and 1,000:1 contrast
- 5:4 aspect ratio with 1,280 x 1,024 pixels
- Especially suitable for urological and arthroscopic applications thanks to 5:4 format
- Internal power supply unit provides direct power supply
- Attention: Power cables are not included in the scope of delivery and must be ordered separately
- Available in two versions: with or without pedestal

CURATOR LX1910-S 6GF62102JL01
with pedestal

CURATOR LX1910 6GF62102JL10
without pedestal

Recommended accessories		Product no.
FLEXION-PORT 300 (58 cm) bundle	Swivel arm Mounting on the side in the aluminum profile	321160581
FLEXION-PORT 350+400 (103 cm) bundle		321161031
FLEXION-PORT 300 (58 cm) bundle	Swivel arm Mounting on the reinforced monitor bridge	321160582
FLEXION-PORT 350+400 (103 cm) bundle		321161032
Power cable, 3 m long		2440.03

VIII23 || Subject to modifications. Please note that some products may not be available in all countries. Please always take note of the information that is provided with the product. For more detailed information, please consult with your contact partner or directly with Richard Wolf GmbH.

LCD monitor 19"

Technical data

CURATOR LX1910-S / CURATOR LX1910		6GF62102JL01 / 6GF62102JL10	
Device properties			
Screen diagonal	19"		
Resolution / aspect ratio	1,280 x 1,024 / 5:4		
Background lighting	LED		
Display colors	16,770,000		
Contrast	1,000:1		
Max. luminance	700 cd/m ²		
Response time	12 ms		
Angle of view	178° H / 178° V		
Equipment			
Video input / output (SD)	in: 1x DVI-I (digital and analog RGBHV), 1x DisplayPort		
VESA mount	VESA 100 x 100		
IP rating	IP20		
Power supply			
Power connection + frequency	100–240 V~, 50/60 Hz		
Power consumption	< 45 VA		
Current rating	Max. 1.0 A		
Power supply unit	Internal power supply unit		
Regulatory standards			
Safety and certifications	CE (medical device), IEC/EN 60601-1, CAN/CSA C22.2 No. 60601-1, ANSI/AAMI ES60601-1, EN 60601-1-2 Class B, FCC-B, RoHS, WEEE, CCC, BIS		
CB certification	IEC/EN 60601-1		
Medical device class	MDD (EU): Class I Medical Device		
Dimensions and weight			
Weight	CURATOR LX1910-S (with pedestal): 6.1 kg		
	CURATOR LX1910 (without pedestal): 4.3 kg		
Dimensions (W x H x D)	CURATOR LX1910-S (with pedestal): 405 x (407~507) x 204 mm		
	CURATOR LX1910 (without pedestal): 405 x 334 x 61 mm		

ENDOLIGHT LED 2.2

LED light source



- The light output is comparable to a 300-watt xenon illuminant
- The LED service life is at least 30,000 hours
- The LED light source reduces power consumption by up to 80% compared to an equivalent xenon light source
- Extremely quiet heatpipe ventilation concept at only 25 dB(A) noise level
- Light cables from different manufacturers (Richard Wolf, Storz, Olympus, ACMI) can directly be connected to the multi-port socket

- Automatic dimming of the light cable socket if the light cable is removed
- Very homogenous illumination of the endoscopic surgical area. No drop in brightness in the peripheral area and no "black spot" in the center
- Very stable color temperature (6500 Kelvin) over the entire LED service life
- Dialog function in conjunction with ENDOCAM Logic camera systems
- Compatible with core nova

Light source ENDOLIGHT LED 2.2 bndl 51640011

Comprising:

1x ENDOLIGHT LED 2.2	5164001
1x patch cable, RJ45 SFTP, 0.5 m	72325378
1x power cable	2440.03

ENDOLIGHT LED 2.2

Technical data

ENDOLIGHT LED 2.2		5164001
Device properties		
Type and number of lamps	1x high-power LED	
Lamp service life	30,000 h	
Brightness in Lumen	1900 lm	
Light output compared to xenon in W	300 W	
Color temperature	6500 K	
Brightness control	0 - 100%	
Noise level	25 dB(A)	
Operating mode	Continuous operation	
Operating conditions	+10°C to +40°C, 30% to 75% rel. humidity, atmospheric pressure 700 hPa to 1060 hPa	
Equipment		
Supported light cables	Wolf, Storz, Olympus, ACMI	
IP rating	IP20	
Cooling method	Passive heatpipe, fan	
Power supply		
Mains + frequency	100-240 VAC, 50/60 Hz	
Power consumption	150 VA	
Current rating	1.1-0.6 A	
Regulatory standards		
Safety	EU: EN 60601-1	
EMC	EN 60601-1-2 / IEC 601-1-2	
Medical device class	Class 1	
Classification	CF	
Dimensions and weight		
Weight	10.5 kg	
Dimensions (W x H x D)	300 x 160 x 421 mm	

ENDOLIGHT LED 2.1

LED light source



- The light output is comparable to a 300-watt xenon illuminant
- The LED service life is at least 30,000 hours
- The LED light source reduces power consumption by up to 80% compared to an equivalent xenon light source
- Extremely quiet heatpipe ventilation concept at only 25 dB(A) noise level
- Automatic dimming of the light cable socket if the light cable is removed
- Very homogenous illumination of the endoscopic surgical area. No drop in brightness in the peripheral area and no "black spot" in the center
- Very stable color temperature (6500 Kelvin) over the entire LED service life

Light source ENDOLIGHT LED 2.1

bndl 51630011

Comprising:

1x ENDOLIGHT LED 2.1 5163001
 1x power cable 2440.03

ENDOLIGHT LED 2.1

Technical data

ENDOLIGHT LED 2.1		5163001
Device properties		
Type and number of lamps	1x high-power LED	
Lamp service life	30,000 h	
Brightness in Lumen	1900 lm	
Light output compared to xenon in W	300 W	
Color temperature	6500 K	
Brightness control	0 - 100%	
Noise level	25 dB(A)	
Operating mode	Continuous operation	
Operating conditions	+10°C to +40°C, 30% to 75% rel. humidity, atmospheric pressure 700 hPa to 1060 hPa	
Equipment		
Supported light cables	Wolf	
IP rating	IP20	
Cooling method	Passive heatpipe, fan	
Power supply		
Mains + frequency	100-240 VAC, 50/60 Hz	
Power consumption	150 VA	
Current rating	1.1-0.6 A	
Regulatory standards		
Safety	EU: EN 60601-1	
EMC	EN 60601-1-2 / IEC 601-1-2	
Medical device class	Class 1	
Classification	CF	
Dimensions and weight		
Weight	9.6 kg	
Dimensions (W x H x D)	300 x 160 x 421 mm	

System green

ENDOLIGHT LEDgreen

LED light source



- LED light source for the endoscopic ICG/NIR application
- Switchable between ICG/NIR and white light endoscopy
- Powerful ICG/NIR illumination
- The light output is comparable to a 300W xenon light source
- Guaranteed LED lamp service life in white light mode 15000h
- Compatible with core nova
- Automatic exposure control and adjustment of light intensity in conjunction with ENDOCAM Logic 4K/HD (dialog functionality) for optimal illumination
- Light output for rigid and flexible endoscopes

Light source LEDgreen bndl 51650021

Comprising:

1x light source LEDgreen	5165002
1x patch cable, RJ45 SFTP, 0.5 m	72325378
1x power cable	2440.03

Optional accessories:

Foot control rockerswitch		2030.105
<i>fusion</i> Fiber light cable bndl comprising: Fiber light cable, Adapter, projector side (8095.07), and adapter, endoscope side (809509)	Ø of fiber bundle 5.0 mm and color code grey	2.3 m long 806550231
		3.0 m long 806550301
		3.5 m long 806550351

System green

ENDOLIGHT LED_{green}

Technical data

ENDOLIGHT LED _{green}		5165002
Device properties		
Type and number of lamps	2x high-power LED	
Lamp service life	15,000 h	
Brightness in Lumen	1,400 lm	
Light output compared to xenon in W	300 W	
Color temperature	8000 K	
Brightness control	0 - 100%	
Noise level	30 dB(A)	
Operating mode	Continuous operation	
Operating conditions	+10°C to +40°C, 20% to 75% rel. humidity, atmospheric pressure 700 hPa to 1060 hPa	
Equipment		
Supported light cables	Wolf	
IP rating	IP20	
Cooling method	Passive heatpipe	
Power supply		
Mains + frequency	100-240 VAC, 50/60 Hz	
Power consumption	225 VA	
Current rating	1.5-0.6 A	
Regulatory standards		
Safety	EU: EN 60601-1	
EMC	EN 60601-1-2 / IEC 601-1-2	
Medical device class	Class 1	
Classification	CF	
Dimensions and weight		
Weight	10.3 kg	
Dimensions (W x H x D)	300 x 160 x 424 mm	

System blue

ENDOLIGHT LED_{blue}

LED light source



5 Light sources

- LED light source for use in photodynamic diagnostics (PDD)
- Switchable between blue light and white light mode
- The light output is comparable to a 180-watt xenon illuminant
- The LED service life is at least 30,000 hours
- The LED light source reduces power consumption by up to 80% compared to an equivalent xenon light source
- Extremely quiet heatpipe ventilation concept at only 25 dB(A) noise level
- Automatic dimming of the light cable socket if the light cable is removed
- Very homogenous illumination of the endoscopic surgical area. No drop in brightness in the peripheral area and no "black spot" in the center
- Very stable color temperature (6500 Kelvin) over the entire LED service life
- Dialog function in conjunction with ENDOCAM Logic camera-systems
- Compatible with **core nova**

Light source ENDOLIGHT LED blue bndl 51650011

Comprising:

1x ENDOLIGHT LED blue	5165001
1x patch cable, RJ45 SFTP, 0.5 m	72325378
1x toggle switch	2030.105
1x power cable	2440.03

VIII23 || Subject to modifications. Please note that some products may not be available in all countries. Please always take note of the information that is provided with the product. For more detailed information, please consult with your contact partner or directly with Richard Wolf GmbH.

System blue

ENDOLIGHT LED_{blue}

Technical data

ENDOLIGHT LED blue		5165001
Device properties		
Type and number of lamps	2x high-power LED	
Lamp service life	30,000 h	
Brightness in Lumen	1,100 lm	
Light output compared to xenon in W	180 W	
Color temperature	6500 K	
Brightness control	0 - 100%	
Noise level	25 dB(A)	
Operating mode	Continuous operation	
Operating conditions	+10°C to +40°C, 30% to 75% rel. humidity, atmospheric pressure 700 hPa to 1060 hPa	
Equipment		
Supported light cables	Wolf	
IP rating	IP20	
Cooling method	Fan	
Power supply		
Mains + frequency	100-240 VAC, 50/60 Hz	
Power consumption	192 VA	
Current rating	1.6-0.8 A	
Regulatory standards		
Safety	EU: EN 60601-1	
EMC	EN 60601-1-2 / IEC 601-1-2	
Medical device class	Class 1	
Classification	CF	
Dimensions and weight		
Weight	10.5 kg	
Dimensions (W x H x D)	300 x 160 x 421 mm	

ENDOLIGHT LED 1.2

LED light source



- The light output is comparable to a 180-watt xenon illuminant
- The LED service life is at least 30,000 hours
- The LED light source reduces power consumption by up to 80% compared to an equivalent xenon light source
- Extremely quiet ventilation concept at only 25 dB(A) noise level
- Light cables from different manufacturers (Richard Wolf, Storz, Olympus, ACMI) can directly be connected to the multi-port socket

- Automatic dimming of the light cable socket if the light cable is removed
- Very homogenous illumination of the endoscopic surgical area. No drop in brightness in the peripheral area and no "black spot" in the center
- Very stable color temperature (6500 Kelvin) over the entire LED service life
- The key brightness is automatically adjusted to the ambient light and so legibility is always good, without any glare

Light source ENDOLIGHT LED 1.2

bndl 51610011

Comprising:

1x ENDOLIGHT LED 1.2 5161001
1x power cable 2440.03

ENDOLIGHT LED 1.2

Technical data

ENDOLIGHT LED 1.2		5161001
Device properties		
Type and number of lamps	1x high-power LED	
Lamp service life	30,000 h	
Brightness in Lumen	1000 lm	
Light output compared to xenon in W	180 W	
Color temperature	6500 K	
Brightness control	0 - 100%	
Noise level	25 dB(A)	
Operating mode	Continuous operation	
Operating conditions	+10°C to +40°C, 30% to 75% rel. humidity, atmospheric pressure 700 hPa to 1060 hPa	
Equipment		
Supported light cables	Wolf, Storz, Olympus, ACMI	
IP rating	IP 20	
Cooling method	Fan	
Power supply		
Mains + frequency	100-240 VAC, 50/60 Hz	
Power consumption	120 VA	
Current rating	1.1-0.5 A	
Regulatory standards		
Safety	EU: EN 60601-1	
EMC	EN 60601-1-2 / IEC 601-1-2	
Medical device class	Class 1	
Classification	CF	
Dimensions and weight		
Weight	8.9 kg	
Dimensions (W x H x D)	300 x 120 x 424 mm	

ENDOLIGHT LED II

LED light source



- The light output is comparable to a 180-watt xenon illuminant
- The LED service life is at least 30,000 hours
- The LED light source reduces power consumption by up to 80% compared to an equivalent xenon light source.
- Extremely quiet ventilation concept at only 25 dB(A) noise level
- Connection option for Richard Wolf light cable
- Automatic dimming of the light cable socket if the light cable is removed
- Very homogenous illumination of the endoscopic surgical area. No drop in brightness in the peripheral area and no "black spot" in the center
- Very stable color temperature (6500 Kelvin) over the entire LED service life
- Very good price-performance ratio

Light source ENDOLIGHT LED 1.1

bndl 5160011

Comprising:

1x ENDOLIGHT LED 1.1 5160001
 1x power cable 2440.03

ENDOLIGHT LED II

Technical data

ENDOLIGHT LED 1.1		5160001
Device properties		
Type and number of lamps	1x high-power LED	
Lamp service life	30,000 h	
Brightness in Lumen	1000 lm	
Light output compared to xenon in W	180 W	
Color temperature	6500 K	
Brightness control	0 - 100%	
Noise level	25 dB(A)	
Operating mode	Continuous operation	
Operating conditions	+10°C to +40°C, 30% to 75% rel. humidity, atmospheric pressure 700 hPa to 1060 hPa	
Equipment		
Supported light cables	Wolf	
IP rating	IP 20	
Cooling method	Fan	
Power supply		
Mains + frequency	100-240 VAC, 50/60 Hz	
Power consumption	120 VA	
Current rating	1.1 - 0.5 A	
Regulatory standards		
Safety	EU: EN 60601-1	
EMC	EN 60601-1-2 / IEC 601-1-2	
Medical device class	Class 1	
Classification	CF	
Dimensions and weight		
Weight	8.5 kg	
Dimensions (W x H x D)	300 x 120 x 421 mm	

ENDOLIGHT Flex LED

LED light source



- Extremely compact design
- The light output is comparable to a 180-watt xenon illuminant
- The LED illuminant exhibits only minimal power loss over the entire service life
- The LED service life is at least 30,000 hours
- The LED light source reduces power consumption by up to 80% compared to an equivalent xenon light source
- Extremely quiet ventilation concept at only 30 dB(A) noise level
- Connection option for Richard Wolf light cable
- Automatic dimming of the light cable socket if the light cable is removed
- Very homogenous illumination of the endoscopic surgical area. No drop in brightness in the peripheral area and no "black spot" in the center
- Very stable color temperature (6500 Kelvin) over the entire LED service life
- Very good price-performance ratio
- VESA 100 mount on the underside - versatile mounting options

Light source ENDOLIGHT Flex LED bndl 51660011

Comprising:

1x ENDOLIGHT Flex LED 5166001
 1x power cable 2440.03

Recommended accessories	Product no.
Device mount VESA 100	32116452

VIII23 || Subject to modifications. Please note that some products may not be available in all countries. Please always take note of the information that is provided with the product. For more detailed information, please consult with your contact partner or directly with Richard Wolf GmbH.

ENDOLIGHT Flex LED

Technical data

ENDOLIGHT Flex LED		5166001
Device properties		
Type and number of lamps	1x high-power LED	
Lamp service life	30,000 h	
Brightness in Lumen	1350 lm	
Light output compared to xenon in W	180 W	
Color temperature	6500 K	
Brightness control	0 - 100%	
Noise level	30 dB(A)	
Operating mode	Continuous operation	
Operating conditions	+10°C to +40°C, 30% to 75% rel. humidity, atmospheric pressure 700 hPa to 1060 hPa	
Equipment		
Supported light cables	Wolf	
IP rating	IP 20	
Cooling method	Fan	
Power supply		
Mains + frequency	100-240 VAC, 50/60 Hz	
Power consumption	110 VA - 145 VA	
Current rating	1.1-0.6 A	
Regulatory standards		
Safety	EU: EN 60601-1	
EMC	EN 60601-1-2 / IEC 601-1-2	
Medical device class	Class 1	
Classification	BF	
Dimensions and weight		
Weight	1.8 kg	
Dimensions (W x H x D)	150 x 58 x 245 mm	

fusion Fiber light cable



fusion

Anti-kink protection under the sheath for optimum hygiene properties

"Snap" quick release coupling

The color ring system for the handle at the endoscope side allows you to easily and quickly assign the matching light cable to the endoscope in use.

Standard Light cables with adhesive

fusion High-temperature-resistant light cables

ø 5.0 mm gray

Innovative color coding system

- Improved light transmission thanks to a special design
- High-performance fiber optic material "made in Germany"
- Fast "snap-on" precision connection between endoscope and light cable
- Anti-kink protection made of steel allows for a particularly high number of usage cycles
- Suitable for low-temperature procedure
- Steam-sterilizable
- Adapters for compatibility with light sources and endoscopes from different manufacturers
- Standardized color coding of light cables and endoscopes based on their diameters



fusion

Fiber light cable are exclusively available with 5.0 mm fiber diameter

Fusion
Fiber light cable

Fusion Fiber light cable, complete	Color coding on endoscope side	Ø of fiber bundle and color code	Length	Fiber light cable without adapter Product no.	Complete Product no.
 <p>Fiber light cable, bndl Comprising: Fiber light cable, Adapter, projector side (8095.07), and adapter, endoscope side (809509)</p>		5.0 mm gray	2.3 m	80655023*	806550231
			3.0 m	80655030*	806550301
			3.5 m	80655035*	806550351

* The *Fusion* light cables can also be ordered without adapter. Adapters for connecting products from other manufacturers are offered as separate items in our product range.

Fiber light cable

Anti-kink protection under the sheath for optimum hygiene properties



"Snap-on" quick release coupling



The color ring **system** for the handle at the endoscope side allows you to easily and quickly assign the matching light cable to the endoscope in use.

ø 1.6 mm	blue
ø 2.5 mm	green
ø 3.5 mm	orange
ø 5.0 mm	gray



Innovative color coding system

- High-performance fiber optic material "made in Germany"
- Fast "snap-on" precision connection between endoscope and light cable
- Anti-kink protection made of steel allows for a particularly high number of usage cycles

- Suitable for low-temperature procedure
- Steam-sterilizable
- Standardized color coding of light cables and endoscopes based on their diameters
- Adapters for compatibility with light sources and endoscopes from different manufacturers



Fiber light cable with color coding

Fiber light cable, complete	Color coding on endoscope side	Ø of fiber bundle and color code	Length	Fiber light cable without adapter Product no.	Complete Product no.
 <p>Fiber light cable, bndl Comprising: Fiber light cable, Adapter, projector side (8095.07), and adapter, endoscope side (809509)</p>		1.6 mm blue	1.8 m	80661618*	806616181
			2.3 m	80661623*	806616231
			3.0 m	80661630*	806616301
		2.5 mm green	1.8 m	80662518*	806625181
			2.3 m	80662523*	806625231
			3.0 m	80662530*	806625301
		3.5 mm orange	1.8 m	80663518*	806635181
			2.3 m	80663523*	806635231
			3.0 m	80663530*	806635301
			3.5 m	80663535*	806635351
		5.0 mm grey	2.3 m	80665023*	806650231
			3.0 m	80665030*	806650301
3.5 m			80665035*	806650351	

* The light cables can also be ordered without adapter.
Adapters for connecting products from other manufacturers are offered as separate items in our product range.

System blue

Fiber light cable

Fiber light cable blue	Color coding on endoscope side	Ø of fiber bundle and color code	Length	Fiber light cable without adapter Product no.	Complete Product no.
 <p>Special fiber light cable, bndl Comprising: Fiber light cable, Adapter, projector side (8095.07), and adapter, endoscope side (809509)</p>		3.5 mm orange	2.3 m	80673523	806735231

- Suitable for low-temperature procedure
- Steam-sterilizable
- Can be used in blue light and white light mode
- Highly flexible design
- Improved light transmission
- High-performance fiber optic material "made in Germany"
- Fast "snap-on" precision connection between endoscope and light cable
- System blue design with blue sheath
- Compatible with all Richard Wolf light sources

Adapter

for RICHARD WOLF light cables - *fusion*sign

Adapters
7

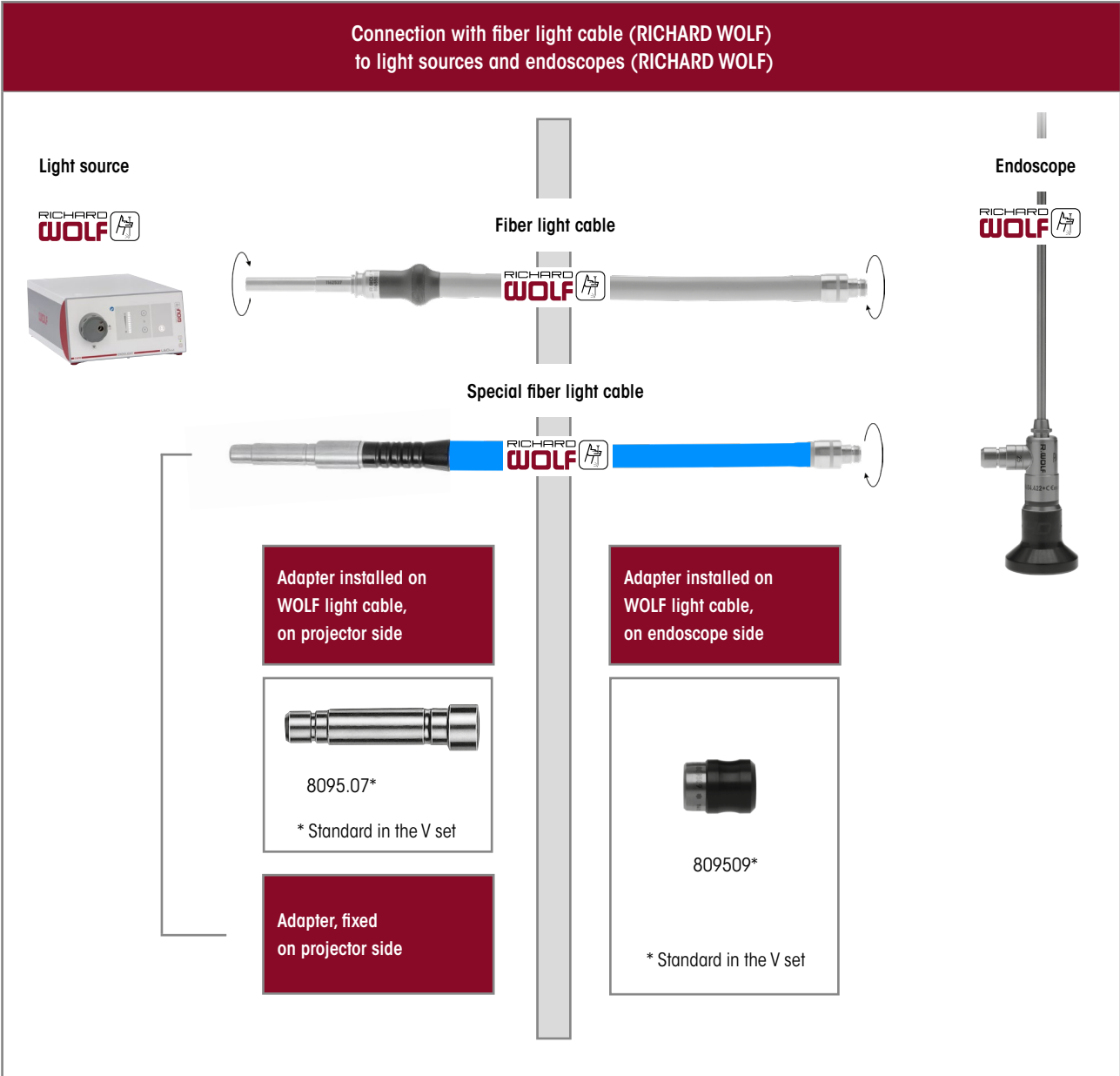

VIII23 || Subject to modifications. Please note that some products may not be available in all countries. Please always take note of the information that is provided with the product. For more detailed information, please consult with your contact partner or directly with Richard Wolf GmbH.

Adapter

for RICHARD WOLF light cables - *fusion*sign

VIII23 || Subject to modifications. Please note that some products may not be available in all countries. Please always take note of the information that is provided with the product. For more detailed information, please consult with your contact partner or directly with Richard Wolf GmbH.

Connection with special fiber light cable (RICHARD WOLF) to light sources (RICHARD WOLF) and endoscopes (other manufacturers)

Light source



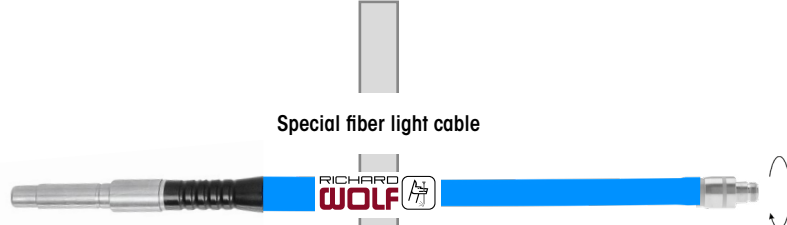

Special fiber light cable

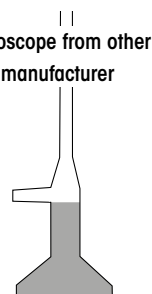

Endoscope from other manufacturer







Adapter installed on WOLF light cable, on projector side	Adapter, fixed on projector side	Adapter installed on WOLF light cable, on endoscope side	Endoscope made by:
		 807002	ACMI + Circon Henke-Hass-Wolf without adapter
			Storz without adapter
			Olympus without adapter
			Stryker without adapter
		 807001	ACMI + Circon Henke-Hass-Wolf
			Storz
			Olympus
			Stryker

Adapter

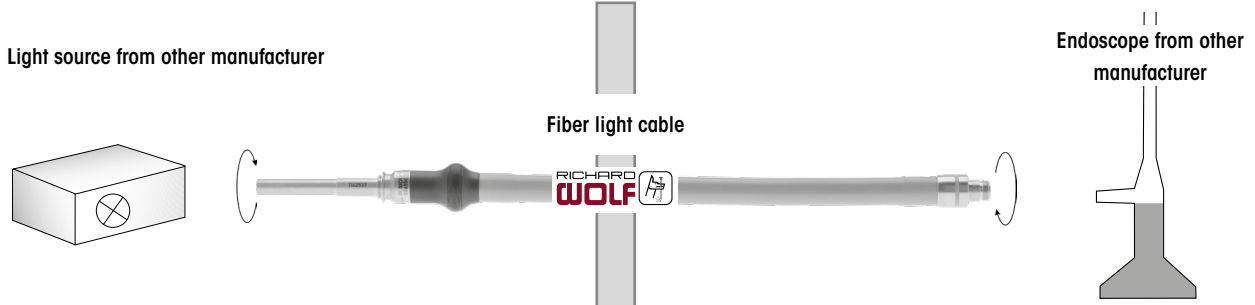
for RICHARD WOLF light cables

Connection with fiber light cable (RICHARD WOLF) to light sources and endoscopes (other manufacturers)



Light source made by:	Adapter on projector side	Adapter on endoscope side	Endoscope made by:
Storz	fits directly		ACMI + Circon Henke-Hass-Wolf without adapter
Olympus	 8096.811	 807002	Storz without adapter
Stryker	 8095.07*		Olympus without adapter
	* Standard in the V set		Stryker without adapter
		 807001	ACMI + Circon Henke-Hass-Wolf
			Storz
			Olympus
			Stryker

Adapters
7

VIII23 || Subject to modifications. Please note that some products may not be available in all countries. Please always take note of the information that is provided with the product. For more detailed information, please consult with your contact partner or directly with Richard Wolf GmbH.

Adapter

for RICHARD WOLF light cables

**Connection with fiber light cable (other manufacturer)
to light sources and endoscopes (RICHARD WOLF)**

Light source



Fiber light cable

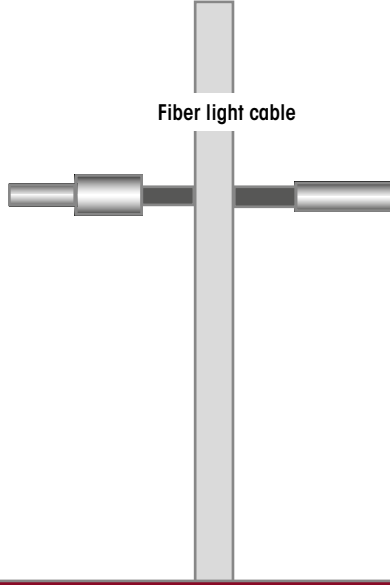

Endoscope

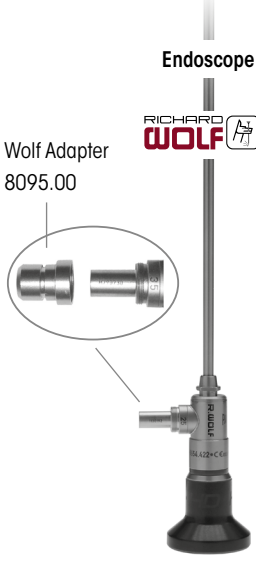





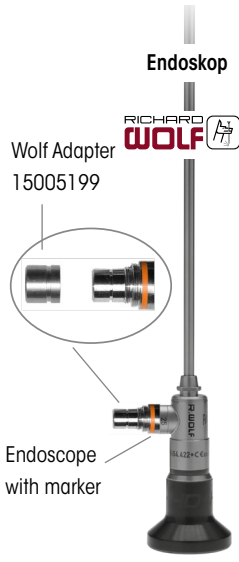

Wolf Adapter
8095.00

Endoskop



Wolf Adapter
15005199

Endoscope
with marker

Adapter on projector side	Fiber light cable made by:	Adapter on endoscope side (without identification rings)	Adapter on endoscope side (with identification rings)
	Storz	 8088.00	 808801
	Olympus (standard)	 8088.80	
	Olympus WA032...A	 8088.81	
	ACMI + Circon)	 8087.00	fits directly
	Stryker (clip-on)		
	Stryker (screw-on)		 808801

VIII23 || Subject to modifications. Please note that some products may not be available in all countries. Please always take note of the information that is provided with the product. For more detailed information, please consult with your contact partner or directly with Richard Wolf GmbH.

Evolution4K Recording System

Digitally records, stores, and archives
4K images and videos



- With one touch, simultaneously records 4K video and captures still images.
- Integrated 12.7 cm touch LCD screen provides intuitive menu navigation and quick setting changes.
- Work list function saves time by allowing cases to be added before they start.
- Records to internal hard drive and to USB 3.0 drives at the same time.
- Fulfills IT security standard by HIPAA compliance according to appropriate user management, system logging and data encryption. (HIPAA: Health Insurance Portability and Accountability Act to ensure the protection of patient data and health data).
- Printing via USB or networkprinter.
- 1 TB internal storage captures up to 40 hours of 4K UHD surgical footage.
- DICOM integration included: DICOM Worklist for automatic patient data import, DICOM Store for media storage.*
- DICOM transfer to archive: Automatic or manual activation, immediate transfer of the media or after closing the case.
- iOS wireless application (MedXStream App) for streaming, live still images, recording 4K video (via USB), surgical records and media review.

Evolution4K Recording System **EVO4K130**
Medical high-definition video recorder

* Connectivity is dependent on existing IT infrastructure.

Evolution4K Recording System

Technical data

Evolution4K Recording System	EVO4K130
Camera / video input resolutions	4K & 4K UHD: 4096x2160p & 3840x2160p, 50/60Hz HD: 1080p, 1080i, 720p
Video file format	AVCHD H.264 encoding .mp4 file format
Still file format	JPEG, PNG
Video inputs	1x HDMI 2.0
Video outputs	1x HDMI 2.0 loop through / pass through
Internal hard drive capacity	1 TB
Outputs for external touchpanels	VGA, DP++, HDMI (only 1 utilized at a time)
Ethernet ports	2x
3D compatibility	Yes, side by side or top/bottom (note: ENDOCAM Epic 3DHD not compatible, only with side by side converter)
Power supply	1 AC/DC medical grade power supply
Remote input	1x 3,5 mm record 1x 3,5 mm capture
USB	2x front side 4x rear side
Dimensions (W x H x D)	210 x 107 x 247 mm
Weight	2.72 kg (6 lbs.)

Sony UP-DR80MD Digital USB printer



- Compact high-quality printer with medical approval
- For PC applications and documentation systems
- Meaningful documentation of diagnostic findings with endoscopic images in HD quality
- Laminate coating on printing paper to protect the surface, resulting in longer storability
- Higher printing speed: A4 page in approx. 76 seconds
- Compact design and aesthetic shape
- Ideal for integration in RIWomobil device cart or for placing it at a nurse workplace

Digital color printer SONY UP-DR80MD 5651051

Color photo print package DIN-A4 UPC-R80MD 5651926
Paper roll for 50 printouts (2 pcs) and ink ribbon (2 pcs)

Technical data	
Device properties	
Printing system	Dye-sublimation printer
Resolution	301 dpi
Printing range (print package 5651926)	A4, 287 x 202 mm (11 3/4 x 8 inches), 3400 x 2392 dots
Printing speed	A4: approx. 76 seconds
Paper tray capacity	50 sheets
Interface	Hi-speed USB (2.0)
Power supply	
Power supply connection	100 - 240 VAC, 50 / 60 Hz
Current rating	3.4 to 1.4 A (max. 340 watts)
Regulatory standards	
Safety	IEC 60601-1, IEC 609950
Dimensions and weight	
Weight	approx. 11.5 kg
Dimensions (W x H x D)	317 x 207 x 425 mm

Universal device cart RIWomobil



All RIWomobil variants

have the following properties in common:

- Integrated cable duct
- 3 shelf units (width 370 mm), 2 of which continuously adjustable
- 4 double casters, 2 of which with dual-function locking (directional locking/freewheeling/full locking)
- Side profiles made of aluminum with mounting points for installing swivel arms and attaching a wide range of accessories
- Dimensions (W x H x D): 720 x 1518 x 700 mm
- 2 casters with dual conductivity
- Color: White, RAL 9016

RIWomobil features the following advantages:

- Order-specific production
Each cart is configured and built according to the customer's individual demands. Any additionally selected shelf units and drawers are installed, adjusted and tested directly in the production process.
- Quality and value preservation
All components are designed for longevity and high loads.
- Safety
All mechanical and electrical components are subjected to our permanent quality control process.
- Ergonomics
On all RIWomobil variants, the monitor position can be adapted to the demands of the operating team. Height-adjustable shelf units and device handles on the cart provide individual adaptation options.

Universal device cart RIWomobil

Your optimum RIWomobil in just 3 steps

1. Where to place the monitors?

RIWomobil provides the option of positioning a swivel arm either in the center on the bridge or laterally in the side profile. As an alternative, a monitor mount can also be used to position a monitor in the center of the bridge.

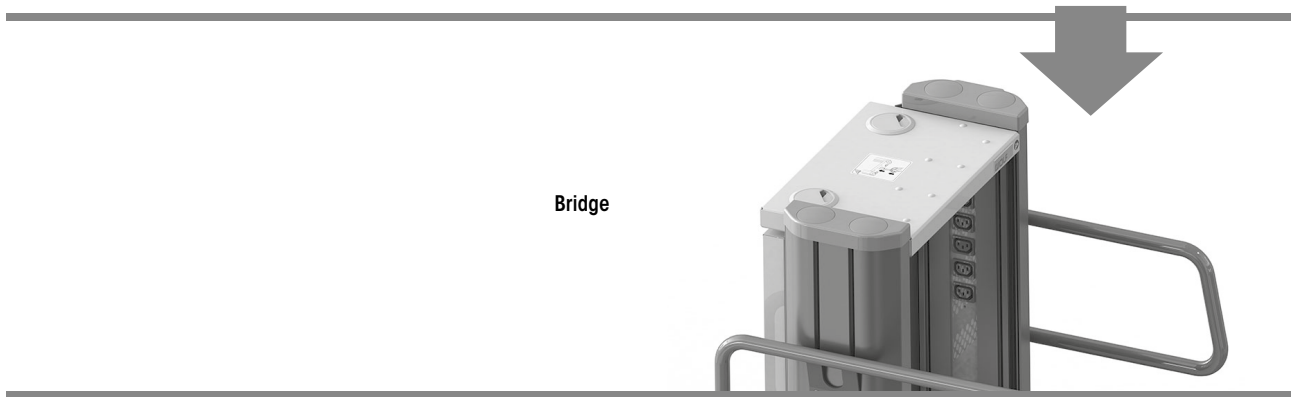

2. Which electrics variant?

The **baseline electrics with a main switch** integrated in the aluminum profile, distributor strip with 12 device connections. The **premium electrics variant for highest demands includes the following elements in addition to the baseline equipment**: isolating transformer and insulation monitoring unit with safety monitoring.

3. Which operating voltage?

RIWomobil with premium electrics

(for accessories, see section Device cart accessories)

Comprising:

Basic housing (premium version) with integrated isolating transformer, insulation monitoring unit, socket strip with main switch module, insulation monitor display and 12 sockets, 6 device connection cables, power cable 5.5 m,

Isolating transformer 220-230V, 2000VA.....**32116015**

Isolating transformer 100-120V, 1700VA.....**32116013**

RIWomobil with baseline electrics

(for accessories, see section Device cart accessories)

Comprising:

Basic housing (baseline version), socket strip with 12 sockets and integrated main switch module, 6 device connection cables, power cable 5.5 m,

Version with 220-240V, 2000VA**32116014**

Version with 100-120V, 1700VA**32116012**

RIWomobil without electrical equipment

For mounting swivel arms**32116011**

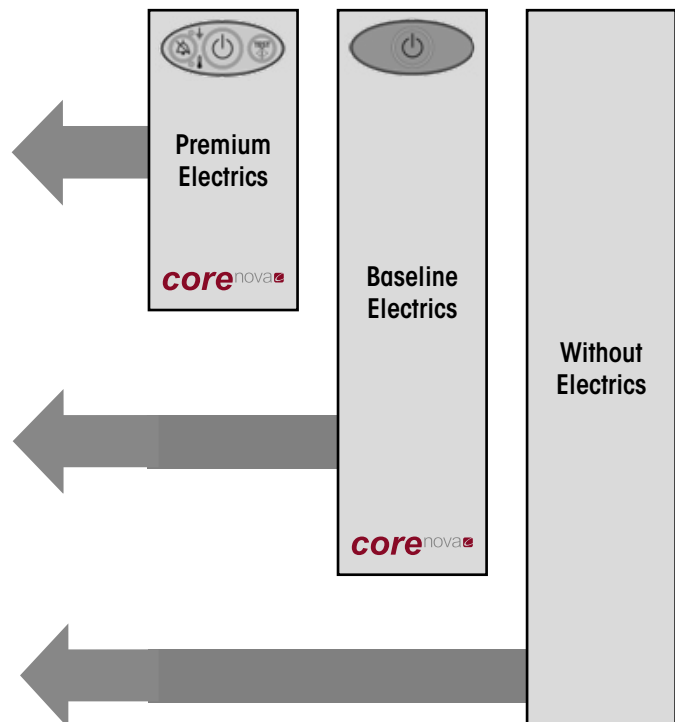

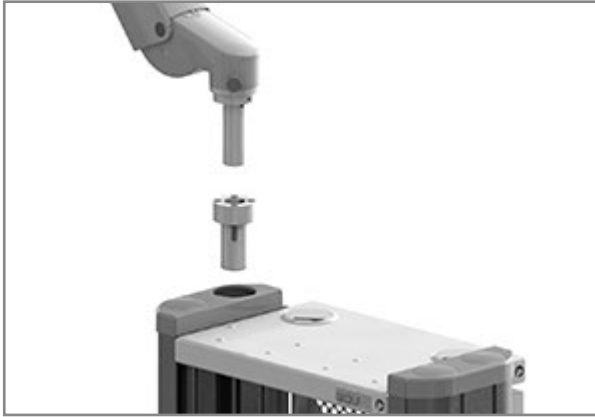

RIWomobil Swivel arm on the side



All Flexion-Port models for mounting in the side profile have the following properties in common:

- VESA 100 mount
- Integrated cable duct
- Mechanical locking
- Swiveling range 340°. The area of the swiveling range can be defined individually during assembly
- Durable powder coating in white (RAL 9016)
- The specified length refers to the effective length between the swivel points
- Adapter for mounting in aluminum profile (32116473) is included in the set

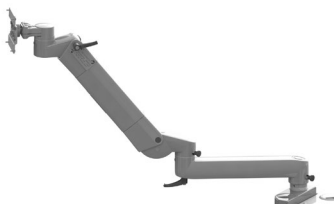
		Product no.
	<p>FLEXION-PORT 300 (58 cm) bndl Load capacity: 3 - 10 kg Comprising: 1x FLEXION-PORT 300 (58 cm) 32116058 1x swivel arm mount for profile 32116473</p>	321160581
	<p>FLEXION-PORT 400 (68 cm) bndl Load capacity: 8 - 14 kg Comprising: 1x FLEXION-PORT 400 (68 cm) 32116068 1x swivel arm mount for profile 32116473</p>	321160681
	<p>FLEXION-PORT 350+300 (93 cm) bndl Load capacity: 8 - 12 kg Comprising: 1x FLEXION-PORT 350+300 (93 cm) 32116093 1x swivel arm mount for profile 32116473</p>	321160931
	<p>FLEXION-PORT 350+400 (103 cm) bndl Load capacity: 3 - 9 kg Comprising: 1x FLEXION-PORT 350+400 (103 cm) 32116103 1x swivel arm mount for profile 32116473</p>	321161031

RIWomobil Swivel arm for bridge

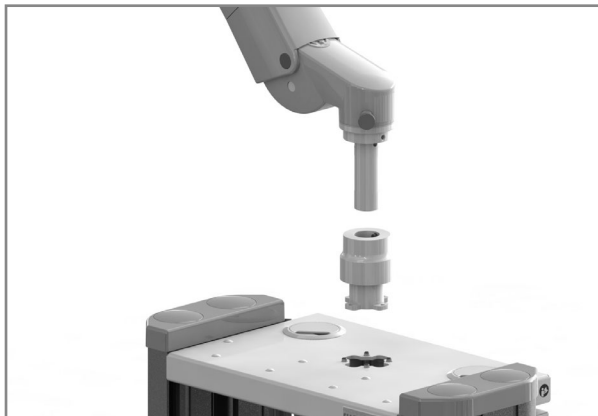



All Flexion-Port models for mounting on the bridge have the following properties in common:

- VESA 100 mount
- Integrated cable duct
- Mechanical locking
- Swiveling range 340°. The area of the swiveling range can be defined individually during assembly
- Durable powder coating in white (RAL 9016)
- The specified length refers to the effective length between the swivel points
- Adapter for mounting on the bridge (32116474) is included in the set

Device carts

9

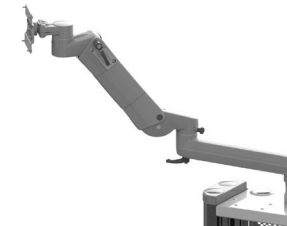
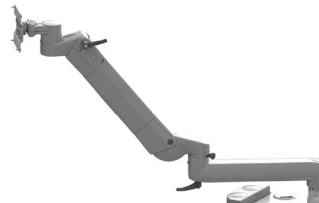



		Product no.
	<p>FLEXION-PORT 300 (58 cm) bndl Load capacity: 3 - 10 kg Comprising: 1x FLEXION-PORT 300 (58 cm) 32116058 1x swivel arm mount for bridge 32116474</p>	321160582
	<p>FLEXION-PORT 400 (68 cm) bndl Load capacity: 8 - 14 kg Comprising: 1x FLEXION-PORT 400 (68 cm) 32116068 1x swivel arm mount for bridge 32116474</p>	321160682
	<p>FLEXION-PORT 350+300 (93 cm) bndl Load capacity: 8 - 12 kg Comprising: 1x FLEXION-PORT 350+300 (93 cm) 32116093 1x swivel arm mount for bridge 32116474</p>	321160932
	<p>FLEXION-PORT 350+400 (103 cm) bndl Load capacity: 3 - 9 kg Comprising: 1x FLEXION-PORT 350+400 (103 cm) 32116103 1x swivel arm mount for bridge 32116474</p>	321161032

VIII23 || Subject to modifications. Please note that some products may not be available in all countries. Please always take note of the information that is provided with the product. For more detailed information, please consult with your contact partner or directly with Richard Wolf GmbH.

RIWomobil Accessories

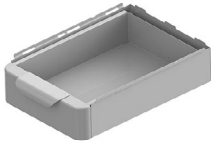
The accessories listed on this page is available in two variants:

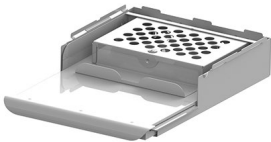

1. Mounting, adjustment and final check during the production process
2. Retrofit kit for assembly by customer

Drawers		Product no.
	Assembly during RIWomobil production Drawer	32116412
	Retrofit kit Drawer	321164121
	Assembly during RIWomobil production Drawer, short, with compartment for power supply unit	32116414
	Retrofit kit Drawer, short, with compartment for power supply unit	321164141
	Pull-out keyboard with mousepad	32116413
	Retrofit kit Pull-out keyboard with mousepad	321164131
Shelf unit to accommodate large devices		
 Dimensions: width: 370 mm, depth: 526 mm	Assembly during RIWomobil production Shelf unit	32116401
	Retrofit kit Shelf unit	321164011
 Dimensions: width: 370 mm, depth: 626 mm	Assembly during RIWomobil production Shelf unit, long	32116402
	Retrofit kit Shelf unit, long	321164021





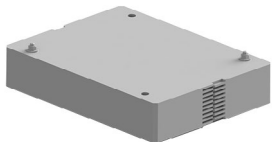

RIWomobil Accessories

The accessories listed on this page is available in two variants:

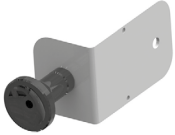
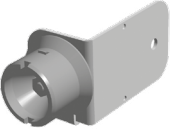
1. Mounting, adjustment and final check during the production process
2. Retrofit kit for assembly by customer

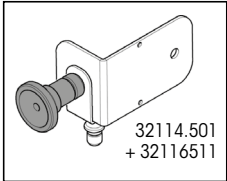
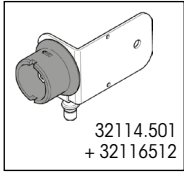
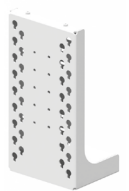
Balancing module to improve tip-over stability for the RIWomobil. Required when mounting swivel arm to RIWomobil 32116xxx without any electrical equipment		Product no.
	Assembly during RIWomobil production Balancing module	32116458
	Retrofit kit Balancing module	321164581
Balancing module to improve tip-over stability for the RIWomobil. Required when mounting swivel arm to RIWomobil 32116xxx with baseline electrics		
	Assembly during RIWomobil production Balancing module for baseline electrics	32116459
	Retrofit kit Balancing module for baseline electrics	321164591
Integrated equipotential bonding rail incl. 6 POAG device cables 0.8 m, 1 POAG supply line 6 m		
	Assembly during RIWomobil production POAG module	32116305
	Retrofit kit POAG module	321163051

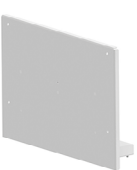
RIWomobil Accessories

Camera holding bracket for universal use with standard and RIWO lenses		Product no.
	<p>Camera holding bracket</p> <p>For universal use with standard and RIWO lenses</p>	32116511
	<p>Camera holding bracket</p> <p>for mounting 3DHD camera heads</p>	32116512
Light cable holder for mounting light cables with R.Wolf connection		
  <p>32114.501 + 32116511</p>  <p>32114.501 + 32116512</p>	<p>Light cable holder</p>	32114501
Monitor mounting bracket		
 <p>Front view</p>  <p>Rear view</p>	<p>Monitor mounting bracket VESA 75 x 100</p> <p>Monitor mounting bracket for installation on the bridge.</p>	321165001
 <p>Front view</p>  <p>Rear view</p>	<p>Monitor mounting bracket VESA 200 x 400</p> <p>Monitor mounting bracket for installation on the bridge.</p>	32116472
	<p>Monitor mounting bracket, lateral, VESA 75/100</p> <p>incl. adapter plate for lateral installation on RIWomobil. Inclining or swiveling, maximum load: 15 kg, length: 5.5 cm</p>	32116451

VIII23 || Subject to modifications. Please note that some products may not be available in all countries. Please always take note of the information that is provided with the product. For more detailed information, please consult with your contact partner or directly with Richard Wolf GmbH.



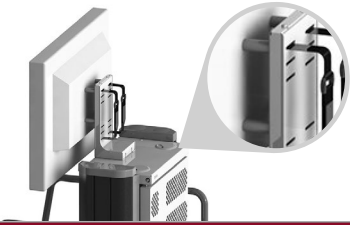
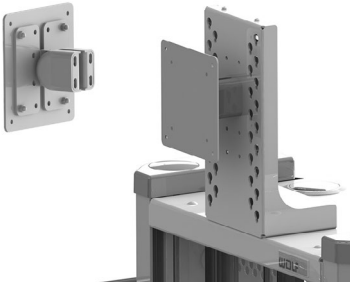
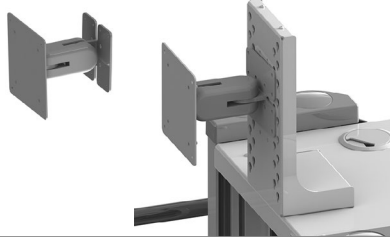
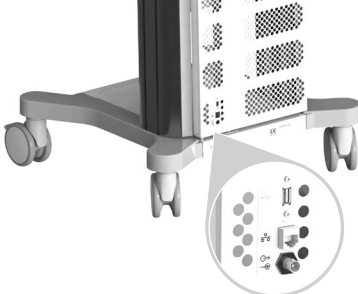
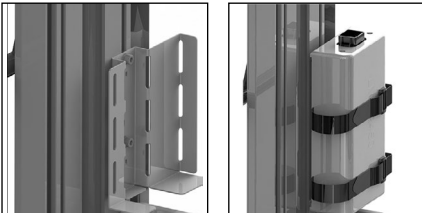



RIWomobil
Accessories

Spacer for monitors on VESA mounts		Product no.
	Spacer for monitors	64031002
Swivel adapter		
	Swivel adapter VESA 75/100 short Inclining or swiveling, maximum load: 15 kg, length: 5.5 cm	32116502
	Swivel adapter VESA 75/100 Inclining and swiveling, maximum load: 15 kg, length: 11 cm	32116501
Adapter		
	Conn. USB, Ethernet, BNC Cable adapter for USB (incl. 0.5 m extension), RJ45 CAT.6A for Ethernet and BNC (for composite, SDI, HD-SDI and 3G-SDI) <i>The feed-through adapter is attached to the rear panel of RIWomobil. Corresponding connections can remain hardwired inside the cart. External cable connections are simply plugged in to the rear of RIWomobil.</i>	32116701
Power supply unit bracket for mounting to side profile of RIWomobil		
	Power supply unit bracket Incl. fixing material for various power supply unit sizes	32116542



VIII23 || Subject to modifications. Please note that some products may not be available in all countries. Please always take note of the information that is provided with the product. For more detailed information, please consult with your contact partner or directly with Richard Wolf GmbH.

RIWomobil Accessories

VIII23 || Subject to modifications. Please note that some products may not be available in all countries. Please always take note of the information that is provided with the product. For more detailed information, please consult with your contact partner or directly with Richard Wolf GmbH.

Infusion bottle holder		Product no.
	<p>Infusion bottle holder adjustable from 1.6 m to 2.6 m, load capacity max. 8 kg</p>	32114.521
CO ₂		
	<p>CO₂ bottle holder, 1 L for bottle ø up to max. 90 mm, load capacity max. 5 kg</p>	32114.531
	<p>CO₂ bottle holder, 10 L for bottle ø up to max. 160 mm, load capacity max. 35 kg</p>	32114.535
Lateral holder		
	<p>Holder for hand-held remote control or camera head connector</p>	64030.106
Footswitch tray and bracket		
	<p>Footswitch tray load capacity max. 3 kg</p>	32114.541
	<p>Universal holder load capacity max. 3 kg</p>	32114.545

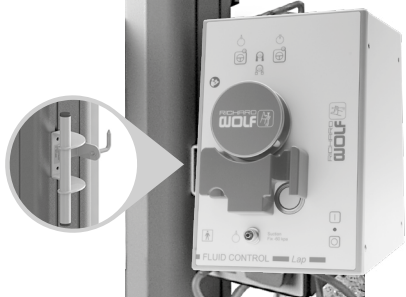
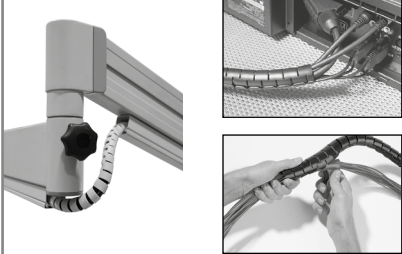
RIWomobil
Accessories

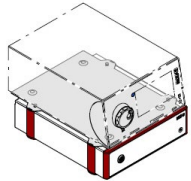
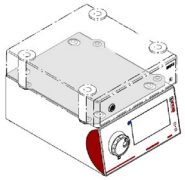
Universal holder 2216		Product no.
	Universal holder 2216 for FLUID CONTROL LAP	32114605
Spiral tube set		
	Spiral tube set for routing on swivel arms, length 2.0 m	74021.031
Transport lock for securing R. Wolf electro-medical devices (width 300 mm)		
	Transport lock	64267001
Adapter plate for combining different housing series		
	Adapter plate for housing cover 330 mm Housing 300 mm (narrow) to housing 330 mm (wide)	64164051
	Adapter plate for housing cover 300 mm Housing 330 mm (wide) to housing 300 mm (narrow)	64164052

Rolling rack UNI-Cart



Equipment cart UNI-Cart 32113202

Mechanically height-adjustable

■ **Device cart UNI-CART**

Base rack, monitor mount, handle, power supply unit bracket, IEC socket strip cable winder, power cable with Schuko plug and IEC socket, IEC cable

Device cart	32113202
Basic rack	with 4 double casters, Ø=100 mm
Monitor mount	VESA 75/100
Holding bracket for power supply unit	large, for supply units with max. 420 mm circumference
IEC socket strip	3 sockets with switch
IEC socket	Length 5 m
IEC cable	Length 1.5 m
max. load	14 kg
Adjustment range (VESA top edge)	1330 - 1630 mm, mechanically height-adjustable
Dimensions (W x H x D)	540 x 1690 x 580 mm

Monitor cart (trolley)



Monitor cart **32116000**

- 4 double casters, 2 of which with dual-function locking (directional locking/freewheeling/full locking)
- 2 electrically conductive casters
- Color: White, RAL 9016
- Dimensions (W x H x D): 720 x 1518 x 700 mm
- Empty weight: 43.5 kg
- Permissible total weight: 300 kg
- Without electrical accessories

Recommended accessories		Product no.
Monitor mounting bracket VESA 75 x 100	Compatible for 31" monitor	321165001
Monitor mounting bracket VESA 200 x 400	Compatible for 31" and 55" monitors	32116472
Balancing module	For advance assembly	32116458
Balancing module	For retrofitting	321164581
Power cable 5.5 m		244007
Velcro fastener belt 25 x 630		74015046

