

## GYNECOLOGY

## GYNECOLOGY

1

---

**GYNECOLOGICAL LAPAROSCOPY**

---

2

---

**HYSTERECTOMY**

---

3

---

**HYSTEROSCOPY**

---

4

---

**INTERDISCIPLINARY APPLICATIONS**

---



**GYNECOLOGICAL  
LAPAROSCOPY**

## GYNECOLOGICAL LAPAROSCOPY

1

**BASIC SETS**

2

**TELESCOPES**

3

**TROCAR SLEEVES/DILATION/EXTRACTION/REDUCING SLEEVES**

4

**ERAGONMODULAR GRASPING FORCEPS/DISSECTORS/BIOPSY FORCEPS/SCISSORS**

5

**GRASPING FORCEPS**

6

**BIPOLAR FORCEPS AND SCISSORS**

7

**HF ELECTRODES (MONOPOLAR/BIPOLAR)**

8

**MULTIFUNCTIONAL SUCTION IRRIGATION SYSTEM**

9

**TISSUE RETRACTOR**

10

**CLIP APPLICATOR**

11

**NEEDLE HOLDER/KNOT PUSHER/FASCIA CLOSURE**

12

**CANNULAS/SURGICAL PROBES/MYOMA DRILLS**

13

**DEVICES/ACCESSORIES**

14

**CHOLEDOCHOSCOPY**

15

**TRAINING MODELS**

## BASIC SET

### FOR ALL LAPAROSCOPIC PROCEDURES

| Product                                 | Product no.     | Quantity | Catalog / Section       |
|---|-----------------|----------|-------------------------|
| Insufflator 45 EVAC + HEAT bndl         | <b>22350311</b> | 1        | Laparoscopy / 14        |
| VERES cannula Ø 2.1 mm WL 152 mm        | <b>8302.12</b>  | 1        | Laparoscopy / 3         |
| LAP suction irrigation pump bndl        | <b>22160011</b> | 1        | Laparoscopy / 14        |
| LED light source ENDOLIGHT LED 2.1 bndl | <b>51630011</b> | 1        | Imaging / Light sources |
| Fiber light cable                       |                 | 1        | Imaging / Light cables  |
| ENDOCAM Logic HD                        | <b>5525</b>     | 1        | Imaging / ENDOCAM       |
| Monitors                                |                 | 1        | Imaging / Monitors      |
| Device cart                             |                 | 1        | Imaging / Device cart   |

## BASIC SET

### FOR LAPAROSCOPIC CHOLECYSTECTOMY

| Product  | Product no.      | Quantity | Catalog / Section |
|--|------------------|----------|-------------------|
| Telescope 30° Ø 10 mm WL 307 mm                    | <b>8934.432</b>  | 1        | Laparoscopy / 2   |
| and/or   |                  |          |                   |
| Telescope 0° Ø 10 mm WL 307 mm                     | <b>8934.431</b>  | 1        | Laparoscopy / 2   |
| Fiber light cable bndl                             | <b>806650231</b> | 1        | Laparoscopy / 2   |
| Trocar sleeve, slanted, capacity 5.5 mm WL 100 mm  | <b>8921.013</b>  | 2-3      | Laparoscopy / 3   |
| and/or   |                  |          |                   |
| Trocar sleeve, straight, capacity 5.5 mm WL 102 mm | <b>8919.351</b>  | 2-3      | Laparoscopy / 3   |
| Trocar sleeve, slanted, capacity 10 mm WL 100 mm   | <b>8923.013</b>  | 2        | Laparoscopy / 3   |
| Guide rod 5.5 mm TL 500 mm                         | <b>8923.921</b>  | 1        | Laparoscopy / 3   |
| Instrument sleeve 10 mm WL 170 mm                  | <b>8385.50</b>   | 1        | Laparoscopy / 3   |
| VERES cannula Ø 2.1 mm WL 152 mm                   | <b>8302.12</b>   | 1        | Laparoscopy / 3   |
| Multifunctional suction irrigation system          |                  |          |                   |
| Suction irrigation tube Ø 5 mm WL 310 mm           | <b>8383.911</b>  | 1        | Laparoscopy / 8   |
| Suction irrigation handle                          | <b>8385.901</b>  | 1        | Laparoscopy / 8   |
| Sealing cap  | <b>8385.902</b>  | 1        | Laparoscopy / 8   |
| <b>ERAGONmodular</b>                               |                  |          |                   |
| Atraumatic grasping forceps Ø 5 mm bndl            | <b>83932925</b>  | 1        | Laparoscopy / 4   |
| Atraumatic grasping forceps mono Ø 5 mm bndl       | <b>83931817</b>  | 2        | Laparoscopy / 4   |
| Maryland dissector forceps mono Ø 5 mm bndl        | <b>83932817</b>  | 1        | Laparoscopy / 4   |
| Metzenbaum scissors Ø 5 mm bndl                    | <b>83930417</b>  | 1        | Laparoscopy / 4   |
| Grasping forceps Ø 10 mm bndl                      | <b>83952048</b>  | 1        | Laparoscopy / 4   |
| Plate-shaped grasping forceps Ø 10 mm bndl         | <b>83952347</b>  | 1        | Laparoscopy / 4   |
| <b>Hook electrode mono Ø 5 mm WL 340 mm</b>        |                  |          |                   |
| Clip applicator Ø 10 mm WL 340 mm                  | <b>8389.911</b>  | 1        | Laparoscopy / 10  |
| Ethicon® Ligaclips® (PACK= 108 PCS)                | <b>8389.915</b>  | 1        | Laparoscopy / 10  |
| Needle forceps Ø 2.45 mm WL 160 mm                 | <b>8756.201</b>  | 1        | Laparoscopy / 11  |
| Sealing cone Ø 12-15 mm                            | <b>8943.915</b>  | 1        | Laparoscopy / 11  |
| Monopolar HF cable                                 | <b>8106</b>      | 2        | Laparoscopy / 14  |

# BASIC SET

## FOR LAPAROSCOPIC CHOLECYSTECTOMY

| Product   | Product no.      | Quantity | Catalog / Section |
|---|------------------|----------|-------------------|
| Also on request:                                  |                  |          |                   |
| Telescope 30° Ø 5.3 mm WL 303 mm                  | <b>8935442</b>   | 1        | Laparoscopy / 2   |
| Trocar sleeve, slanted, capacity 5.5 mm WL 100 mm | <b>8921.013</b>  | 1        | Laparoscopy / 3   |
| Trocar tip sharp size 5.5 mm WL 169 mm            | <b>8921.113</b>  | 1        | Laparoscopy / 3   |
| ERAGONmodular                                     |                  |          |                   |
| Atraumatic grasping forceps mono Ø 5 mm bndl      | <b>83931957</b>  | 1        | Laparoscopy / 4   |
| Biopsy forceps mono Ø 5 mm bndl                   | <b>83930937</b>  | 1        | Laparoscopy / 4   |
| Dissector forceps Ø 10 mm bndl                    | <b>83952268</b>  | 1        | Laparoscopy / 4   |
| ERAGONbipolar                                     |                  |          |                   |
| Grasping forceps bipo Ø 5.5 mm bndl               | <b>839300312</b> | 1        | Laparoscopy / 6   |

| In addition to laparoscopic choledochus revision |                |   |                 |
|--|----------------|---|-----------------|
| Grasping forceps Ø 5 mm WL 295 mm                | <b>8383311</b> | 1 | Laparoscopy / 5 |

## BASIC SET

### FOR LAPAROSCOPIC APPENDECTOMY

| Product  | Product no.      | Quantity | Catalog / Section |
|--|------------------|----------|-------------------|
| Telescope 30° Ø 10 mm WL 307 mm                    | <b>8934.432</b>  | 1        | Laparoscopy / 2   |
| and/or   |                  |          |                   |
| Telescope 0° Ø 10 mm WL 307 mm                     | <b>8934.431</b>  | 1        | Laparoscopy / 2   |
| Fiber light cable bndl                             | <b>806650231</b> | 1        | Laparoscopy / 2   |
| Trocar sleeve, slanted, capacity 10 mm WL 100 mm   | <b>8923.013</b>  | 2        | Laparoscopy / 3   |
| Trocar tip sharp size 10 mm                        | <b>8923.113</b>  | 2        | Laparoscopy / 3   |
| and/or   |                  |          |                   |
| Trocar sleeve, straight, capacity 5.5 mm WL 102 mm | <b>8919.351</b>  | 2-3      | Laparoscopy / 3   |
| Trocar tip sharp size 5.5 mm WL 144 mm             | <b>8919.3512</b> | 2-3      | Laparoscopy / 3   |
| Trocar sleeve, slanted, capacity 5.5 mm WL 100 mm  | <b>8921.013</b>  | 2-3      | Laparoscopy / 3   |
| Trocar tip sharp size 5.5 mm WL 169 mm             | <b>8921.113</b>  | 2-3      | Laparoscopy / 3   |
| Guide rod 5.5 mm TL 500 mm                         | <b>8923.921</b>  | 1        | Laparoscopy / 3   |
| Instrument sleeve 10 mm WL 170 mm                  | <b>8385.50</b>   | 1        | Laparoscopy / 3   |
| <b>ERAGONmodular</b>                               |                  |          |                   |
| Grasping forceps mono Ø 5 mm bndl                  | <b>83932877</b>  | 1        | Laparoscopy / 4   |
| Atraumatic grasping forceps mono Ø 5 mm bndl       | <b>83931817</b>  | 2        | Laparoscopy / 4   |
| Maryland dissector forceps mono Ø 5 mm bndl        | <b>83932817</b>  | 1        | Laparoscopy / 4   |
| Metzenbaum scissors Ø 5 mm bndl                    | <b>83930417</b>  | 1        | Laparoscopy / 4   |
| Grasping and dissector forceps 5 mm                | <b>83932827</b>  | 1        | Laparoscopy / 4   |
| <b>ERAGONbipolar</b>                               |                  |          |                   |
| Grasping forceps bipo Ø 5.5 mm bndl                | <b>839300312</b> | 1        | Laparoscopy / 6   |
| <b>Multifunctional suction irrigation system</b>   |                  |          |                   |
| Suction irrigation tube Ø 5 mm WL 310 mm           | <b>83839.11</b>  | 1        | Laparoscopy / 8   |
| Suction irrigation handle                          | <b>8385.901</b>  | 1        | Laparoscopy / 8   |
| Sealing cap  | <b>8385.902</b>  | 1        | Laparoscopy / 8   |
| <b>Surgical probe Ø 5 mm WL 328 mm</b>             |                  |          |                   |
| Surgical probe Ø 5 mm WL 328 mm                    | <b>8383.66</b>   | 1        | Laparoscopy / 12  |
| VERES cannula Ø 2.1 mm WL 152 mm                   | <b>8302.12</b>   | 1        | Laparoscopy / 3   |
| Bipolar HF cable                                   | <b>8108</b>      | 1        | Laparoscopy / 14  |
| Monopolar HF cable                                 | <b>8106</b>      | 1        | Laparoscopy / 14  |



# BASIC SET

## FOR LAPAROSCOPIC APPENDECTOMY

| Product                                 | Product no.     | Quantity | Catalog / Section |
|---|-----------------|----------|-------------------|
| Also on request:                        |                 |          |                   |
| ERAGONmodular                           |                 |          |                   |
| Dissector forceps mono Ø 5 mm bndl      | <b>83932897</b> | 1        | Laparoscopy / 4   |
| Grasping forceps mono Ø 5 mm bndl       | <b>83931837</b> | 2        | Laparoscopy / 4   |
| Biopsy forceps mono Ø 5 mm bndl         | <b>83930917</b> | 1        | Laparoscopy / 4   |
| Maryland dissector forceps Ø 10 mm bndl | <b>83952257</b> | 1        | Laparoscopy / 4   |
|   |                 |          |                   |
| Clip applicator Ø 10 mm WL 340 mm       | <b>8389.911</b> | 1        | Laparoscopy / 10  |
| Ethicon® Ligaclips® (PACK= 108 PCS)     | <b>8389.915</b> | 1        | Laparoscopy / 10  |
| Introduction sleeve 10 mm WL 80 mm      | <b>8389.991</b> | 1        | Laparoscopy / 10  |
| Needle holder Ø 5 mm bndl               | <b>8393.502</b> | 1        | Laparoscopy / 11  |

|||23 || Subject to modifications. Please note that some products may not be available in all countries. Please always take note of the information that is provided with the product. For more detailed information, please consult with your contact partner or directly with Richard Wolf GmbH.

## BASIC SET LEVD

### LAPAROSCOPIC SINGLE-CHANNEL VARICOCELE DISSECTION

| Product  | Product no.      | Quantity | Catalog / Section |
|--|------------------|----------|-------------------|
| OR endoscope bndl                                  | <b>8920.4011</b> | 1        | Laparoscopy / 2   |
| Perforated basket for telescope                    | <b>38008</b>     |          | Laparoscopy / 2   |
| Fiber light cable bndl                             | <b>806625231</b> | 1        | Laparoscopy / 2   |
| Trocar sleeve, straight, capacity 5.5 mm WL 102 mm | <b>8919.353</b>  | 1        | Laparoscopy / 3   |
| Optional:  |                  |          |                   |
| Trocar tip blunt size 5.5 mm WL 144 mm             | <b>8919.3511</b> | 1        | Laparoscopy / 3   |
| Trocar tip sharp size 5.5 mm WL 144 mm             | <b>8919.3512</b> | 1        | Laparoscopy / 3   |
| Trocar tip triangular size 5.5 mm WL 144 mm        | <b>8919.3513</b> | 1        | Laparoscopy / 3   |
| ERAGONmodular mini                                 |                  |          |                   |
| Universal grasping forceps Ø 3.5 mm bndl           | <b>83912097</b>  | 1        | Laparoscopy / 4   |
| Atraumatic grasping forceps Ø 3.5 mm bndl          | <b>83912087</b>  | 1        | Laparoscopy / 4   |
| Babcock forceps Ø 3.5 mm bndl                      | <b>83912107</b>  | 1        | Laparoscopy / 4   |
| Dissector forceps mono Ø 3.5 mm bndl               | <b>83912077</b>  | 1        | Laparoscopy / 4   |
| Hook scissors mono Ø 3.5 mm bndl                   | <b>83912277</b>  | 1        | Laparoscopy / 4   |
| Metzenbaum scissors mono Ø 3.5 mm bndl             | <b>83912247</b>  | 1        | Laparoscopy / 4   |
| Connection cable                                   |                  |          |                   |
| Bipolar HF cable                                   | <b>8108</b>      | 1        | Laparoscopy / 14  |
| Monopolar HF cable                                 | <b>8106</b>      | 1        | Laparoscopy / 14  |

# BASIC SET

## E-MILOS

| Product  | Product no.     | Quantity | Catalog / Section |
|--|-----------------|----------|-------------------|
| Telescope 30° Ø 10 mm WL 307 mm                    | <b>8934.432</b> | 1        | Laparoscopy / 2   |
| Light tube for MILOS method Ø 10 mm                | <b>893420</b>   | 1        | Laparoscopy / 2   |
| Trocar sleeve, straight, capacity 3.5 mm WL 100 mm | <b>8903.014</b> | 2        | Laparoscopy / 3   |
| Trocar tip blunt size 3.5 mm WL 169 mm             | <b>8903.103</b> | 2        | Laparoscopy / 3   |
| <b>ERAGONmodular mini</b>                          |                 |          |                   |
| Handle, pistol-shaped, mono                        | <b>83930073</b> | 4        | Laparoscopy / 4   |
| Sheath tube insulated Ø 3.5 mm SL 330 mm           | <b>8391933</b>  | 4        | Laparoscopy / 4   |
| Dissector forceps insert Ø 3.5 mm                  | <b>8391222</b>  | 1        | Laparoscopy / 4   |
| Metzenbaum scissors insert Ø 3.5 mm                | <b>8391215</b>  | 1        | Laparoscopy / 4   |
| Grasping forceps insert Ø 3.5 mm                   | <b>8391208</b>  | 2        | Laparoscopy / 4   |
| <b>Electrode</b>                                   |                 |          |                   |
| Hook electrode mono Ø 3.5 mm WL 310 mm             | <b>8379.452</b> | 1        | Laparoscopy / 7   |
| <b>ERAGONstitch</b>                                |                 |          |                   |
| Needle holder insert Ø 3.5 mm                      | <b>8391506</b>  | 1        | Laparoscopy / 11  |
| Sheath tube Ø 3.5 mm SL 330 mm                     | <b>8391533</b>  | 1        | Laparoscopy / 11  |
| Needle holder handle, axial                        | <b>8393943</b>  | 1        | Laparoscopy / 11  |

## BASIC SET

### MINI E-MILOS

| Product  | Product no.     | Quantity | Catalog / Section |
|--|-----------------|----------|-------------------|
| Telescope 30° Ø 10 mm WL 307 mm                    | <b>8934.432</b> | 1        | Laparoscopy / 2   |
| Light tube for MILOS method Ø 10 mm                | <b>893420</b>   | 1        | Laparoscopy / 2   |
| Trocar sleeve, straight, capacity 5.5 mm WL 100 mm | <b>8921.014</b> | 2        | Laparoscopy / 3   |
| Trocar tip blunt size 5.5 mm WL 169 mm             | <b>8921.103</b> | 2        | Laparoscopy / 3   |
| <b>ERAGONmodular</b>                               |                 |          |                   |
| Handle, pistol-shaped, mono                        | <b>83930073</b> | 4        | Laparoscopy / 4   |
| Sheath tube insulated Ø 5 mm SL 330 mm             | <b>8391933</b>  | 4        | Laparoscopy / 4   |
| Dissector forceps insert Ø 5 mm                    | <b>8393240</b>  | 1        | Laparoscopy / 4   |
| Metzenbaum scissors insert Ø 5 mm                  | <b>8393.041</b> | 1        | Laparoscopy / 4   |
| Grasping forceps insert Ø 3.5 mm                   | <b>8393.181</b> | 2        | Laparoscopy / 4   |
| <b>Electrode</b>                                   |                 |          |                   |
| Hook electrode mono Ø 5 mm WL 340 mm               | <b>8383.423</b> | 1        | Laparoscopy / 7   |
| <b>ERAGONstitch</b>                                |                 |          |                   |
| Needle holder insert Ø 5 mm                        | <b>8393508</b>  | 1        | Laparoscopy / 11  |
| Sheath tube Ø 5 mm SL 330 mm                       | <b>8393533</b>  | 1        | Laparoscopy / 11  |
| Needle holder handle, axial                        | <b>8393943</b>  | 1        | Laparoscopy / 11  |

# BASIC SET

## LAPAROSCOPIC BARIATRIC SURGERY

| Product   | Product no.      | Quantity | Catalog / Section |
|---|------------------|----------|-------------------|
| Telescope 0° Ø 10 mm WL 305 mm                        | <b>8934461</b>   | 1        | Laparoscopy / 2   |
| Telescope 30° Ø 10 mm WL 305 mm                       | <b>8934462</b>   | 1        | Laparoscopy / 2   |
| Fiber light cable bndl                                | <b>806550231</b> | 1        | Laparoscopy / 2   |
| Trocar sleeve, straight, capacity 5.5 mm WL 150 mm    | <b>8921.016</b>  | 3        | Laparoscopy / 3   |
| Trocar sleeve, straight, capacity 10 mm WL 150 mm     | <b>8923.016</b>  | 1        | Laparoscopy / 3   |
| Trocar sleeve, straight, capacity 12.5 mm WL 150 mm   | <b>8924.016</b>  | 1        | Laparoscopy / 3   |
| <b>Optional:</b>                                      |                  |          |                   |
| Trocar tip sharp size 5.5 mm                          | <b>8921.115</b>  | 3        | Laparoscopy / 3   |
| Trocar tip sharp size 10 mm                           | <b>8923.115</b>  | 1        | Laparoscopy / 3   |
| Trocar tip sharp size 12.7 mm                         | <b>8924.115</b>  | 1        | Laparoscopy / 3   |
| Reducing adapter                                      | <b>8923.802</b>  | 1        | Laparoscopy / 3   |
| <b>Multifunctional suction irrigation system</b>      |                  |          |                   |
| Suction irrigation tube Ø 5 mm WL 450 mm              | <b>8384.911</b>  | 1        | Laparoscopy / 8   |
| Suction irrigation handle                             | <b>8385.901</b>  | 1        | Laparoscopy / 8   |
| Sealing cap   | <b>8385.902</b>  | 1        | Laparoscopy / 8   |
| Suction irrigation tube set with piercing spike L 3 m | <b>4170.956</b>  | 1        | Laparoscopy / 8   |
| <b>ERAGONmodular</b>                                  |                  |          |                   |
| Atraumatic grasping forceps mono Ø 5 mm bndl          | <b>83941817</b>  | 1        | Laparoscopy / 4   |
| Dissector forceps mono Ø 5 mm bndl                    | <b>83942407</b>  | 1        | Laparoscopy / 4   |
| Metzenbaum scissors mono Ø 5 mm bndl                  | <b>83940417</b>  | 1        | Laparoscopy / 4   |
| Atraumatic Grasping forceps Ø 5 mm bndl               | <b>83942297</b>  | 1        | Laparoscopy / 4   |
| Biopsy forceps mono Ø 5 mm bndl                       | <b>83940917</b>  | 1        | Laparoscopy / 4   |
| Atraumatic Grasping forceps Ø 5 mm bndl               | <b>83942507</b>  | 1        | Laparoscopy / 4   |
| Stapler head grasping forceps Ø 10 mm bndl            | <b>83976558</b>  | 1        | Laparoscopy / 4   |
| Plate-shaped grasping forceps Ø 10 mm bndl            | <b>83962347</b>  | 1        | Laparoscopy / 4   |
| Babcock forceps Ø 10 mm bndl                          | <b>83961877</b>  | 1        | Laparoscopy / 4   |
| <b>ERAGONbipolar</b>                                  |                  |          |                   |
| Maryland dissector bipo Ø 5.5 mm bndl                 | <b>839400322</b> | 1        | Laparoscopy / 6   |
| Metzenbaum scissors bipo Ø 5.5 mm bndl                | <b>839400412</b> | 1        | Laparoscopy / 6   |
| <b>Electrode</b>                                      |                  |          |                   |
| Hook electrode mono Ø 5 mm WL 420 mm                  | <b>8384.423</b>  | 1        | Laparoscopy / 7   |

## BASIC SET

### LAPAROSCOPIC BARIATRIC SURGERY

| Product   | Product no.     | Quantity | Catalog / Section |
|---|-----------------|----------|-------------------|
| Clip applicator Ø 10 mm WL 340 mm                                 | <b>8389.911</b> | 1        | Laparoscopy / 10  |
| Ethicon® Ligaclips® (PACK= 108 PCS)                               | <b>8389.915</b> | 1        | Laparoscopy / 10  |
| Needle holder Ø 5 mm bndl with carbide insert                     | <b>8394.502</b> | 1        | Laparoscopy / 11  |
| Needle holder Ø 5 mm bndl curved to the right with carbide insert | <b>8394.511</b> | 1        | Laparoscopy / 11  |
| Needle forceps Ø 2.45 mm WL 160 mm                                | <b>8756.201</b> | 1        | Laparoscopy / 11  |
| Sealing cone Ø 12–15 mm   | <b>8943.915</b> | 1        | Laparoscopy / 11  |
| Sealing cone Ø 10–12 mm   | <b>8934.915</b> | 1        | Laparoscopy / 11  |
| VERES cannula Ø 2.1 mm WL 152 mm                                  | <b>8302.12</b>  | 1        | Laparoscopy / 3   |
| Handle, axial, mono   | <b>83930084</b> | 1        | Laparoscopy / 14  |
| Rotatable knob  | <b>8988</b>     | 1        | Laparoscopy / 14  |
| <b>Connection cable</b>   |                 |          |                   |
| Mono HF connection cable L 3 m                                    | <b>8106.033</b> | 1        | Laparoscopy / 13  |
| Bipo HF connection cable L 3 m                                    | <b>8108.132</b> | 1        | Laparoscopy / 13  |

## MINI FIBER TELESCOPES 2.0 MM

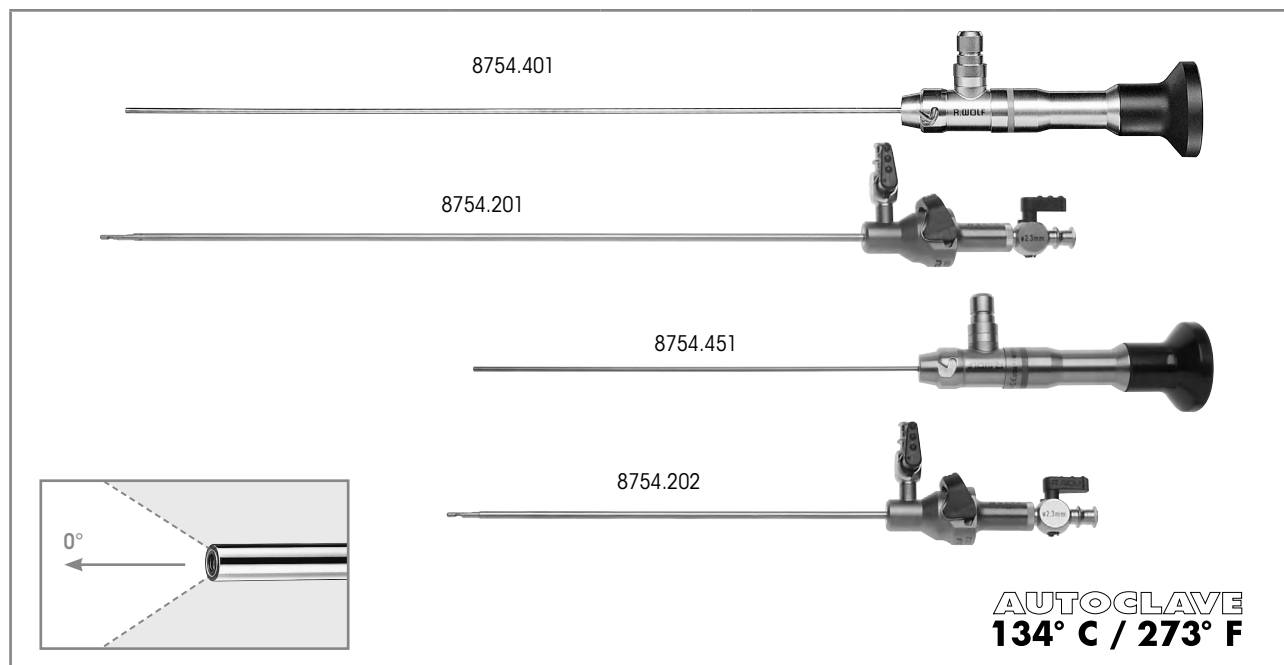

| Long version  | Direction of view | WL                           | TL     | Ø      | Product no.      |
|---|-------------------|------------------------------|--------|--------|------------------|
| Telescope 0° Ø 2 mm NL 268 mm   | 0°                | 268 mm                       | 365 mm | 2.0 mm | <b>8754.401</b>  |
| <b>for this:</b>  |                   |                              |        |        |                  |
| <b>VERES cannula Ø 2.3 mm WL 250 mm</b><br>consisting of:<br>1x VERES cannula Ø 2.3 mm WL 274 mm (8754.211)<br>1x outer sheath Ø 2.8 mm, WL 250 mm (8754.221) |                   | 250 mm                       |        | 2.3 mm | <b>8754.201</b>  |
| Short version   | Direction of view | WL                           | TL     | Ø      | Product no.      |
| Telescope 0° Ø 2 mm NL 158 mm   | 0°                | 158 mm                       | 255 mm | 2.0 mm | <b>8754.451</b>  |
| <b>for this:</b>  |                   |                              |        |        |                  |
| <b>VERES cannula Ø 2.3 mm WL 170 mm</b><br>consisting of:<br>1x VERES cannula Ø 2.3 mm WL 164 mm (8754.212)<br>1x outer sheath Ø 2.8 mm WL 141 mm (8754.222)  |                   | 170 mm                       |        | 2.3 mm | <b>8754.202</b>  |
| Recommended accessories   |                   |                              |        |        | Product no.      |
| Perforated basket for standard telescope 1 (for telescope 8754.451)   |                   | (W x H x D) 297 x 54 x 59 mm |        |        | <b>38015</b>     |
| Perforated basket for standard telescope 2 (for telescope 8754.401)   |                   | (W x H x D) 481 x 54 x 59 mm |        |        | <b>38016</b>     |
| <b>Fiber light cable bndl</b><br>consisting of:<br>Fiber light cable (80662523), projector-side adapter (8095.07),<br>and endoscope-side adapter (809509)     |                   | Ø 2.5 mm, 2.3 m long         |        |        | <b>806625231</b> |

# LAPAROSCOPES 3.5 MM

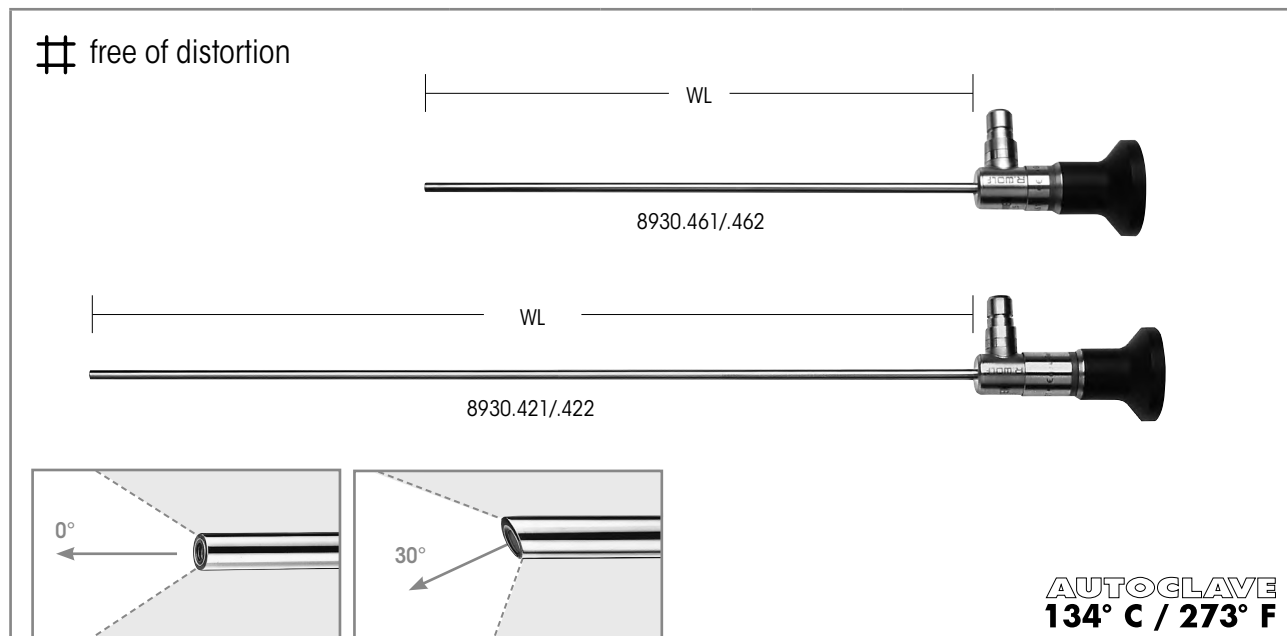

|  | Direction of view | WL     | TL     | Ø      | Product no.     |
|--|-------------------|--------|--------|--------|-----------------|
| PANOVIEW PLUS<br>Telescope 0° 3.5 mm WL 180 mm   | 0°                | 180 mm | 232 mm | 3.5 mm | <b>8930.461</b> |
| PANOVIEW PLUS<br>Telescope 30° 3.5 mm WL 180 mm  | 30°               |        | 233 mm |        | <b>8930.462</b> |
| PANOVIEW PLUS<br>Telescope 0° Ø 3.5 mm WL 300 mm | 0°                | 300 mm | 361 mm |        | <b>8930.421</b> |
| PANOVIEW PLUS<br>Telescope 30° 3.5 mm WL 300 mm  | 30°               |        | 362 mm |        | <b>8930.422</b> |

| Recommended accessories   |                              | Product no.      |
|---|------------------------------|------------------|
| <b>Perforated basket for standard telescope 1</b><br>(for telescope 8930.461/.462)  | (W x H x D) 297 x 54 x 59 mm | <b>38015</b>     |
| <b>Perforated basket for standard telescope 2</b><br>(for telescope 8930.421/.422)  | (W x H x D) 481 x 54 x 59 mm | <b>38016</b>     |
| <b>Fiber light cable bndl</b><br>consisting of:<br>Fiber light cable (80662523), projector-side adapter (8095.07),<br>and endoscope-side adapter (809509) | Ø 2.5 mm, 2.3 m long         | <b>806625231</b> |

III23 | Subject to modifications. Please note that some products may not be available in all countries. Please always take note of the information that is provided with the product. For more detailed information, please consult with your contact partner or directly with Richard Wolf GmbH.



# LAPAROSCOPES 5.3 MM

# free of distortion

full screen

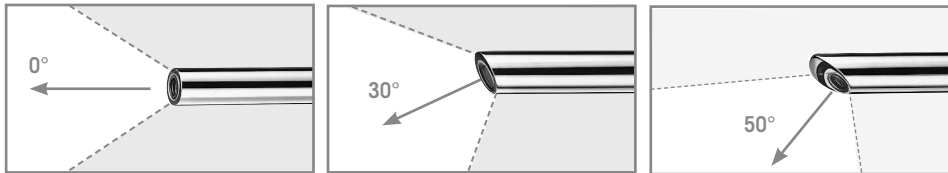
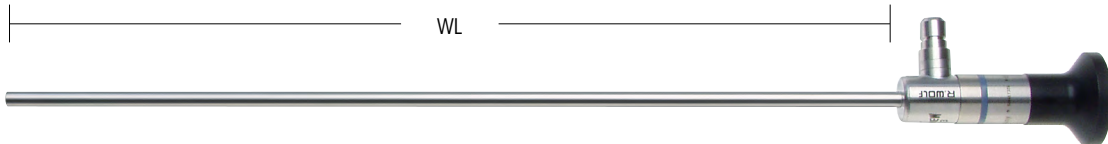

**AUTOCLAVE**  
**134° C / 273° F**

|  | Direction of view | WL     | TL     | Ø      | Product no.     |
|--|-------------------|--------|--------|--------|-----------------|
| PANOVIEW<br>Telescope 0° Ø 5.3 mm WL 303 mm  | 0°                | 303 mm | 372 mm | 5.3 mm | <b>8935.441</b> |
| PANOVIEW<br>Telescope 30° Ø 5.3 mm WL 303 mm | 30°               |        | 373 mm |        | <b>8935.442</b> |
| PANOVIEW<br>Telescope 50° Ø 5.3 mm WL 309 mm | 50°               | 309 mm | 377 mm |        | <b>8935.443</b> |

| Recommended accessories   |                              | Product no.      |
|---|------------------------------|------------------|
| <b>Perforated basket for standard telescope 2</b>   | (W x H x D) 481 x 54 x 59 mm | <b>38016</b>     |
| <b>Fiber light cable bndl</b><br>consisting of:<br>Fiber light cable (80662523), projector-side adapter (8095.07), and<br>endoscope-side adapter (809509) | Ø 2.5 mm, 2.3 m long         | <b>806625231</b> |

11123 || Subject to modifications. Please note that some products may not be available in all countries. Please always take note of the information that is provided with the product. For more detailed information, please consult with your contact partner or directly with Richard Wolf GmbH.

# MINI OR LAPAROSCOPE

## 5.5 MM WITH 3.5 MM WORKING CHANNEL

TELESCOPES

2

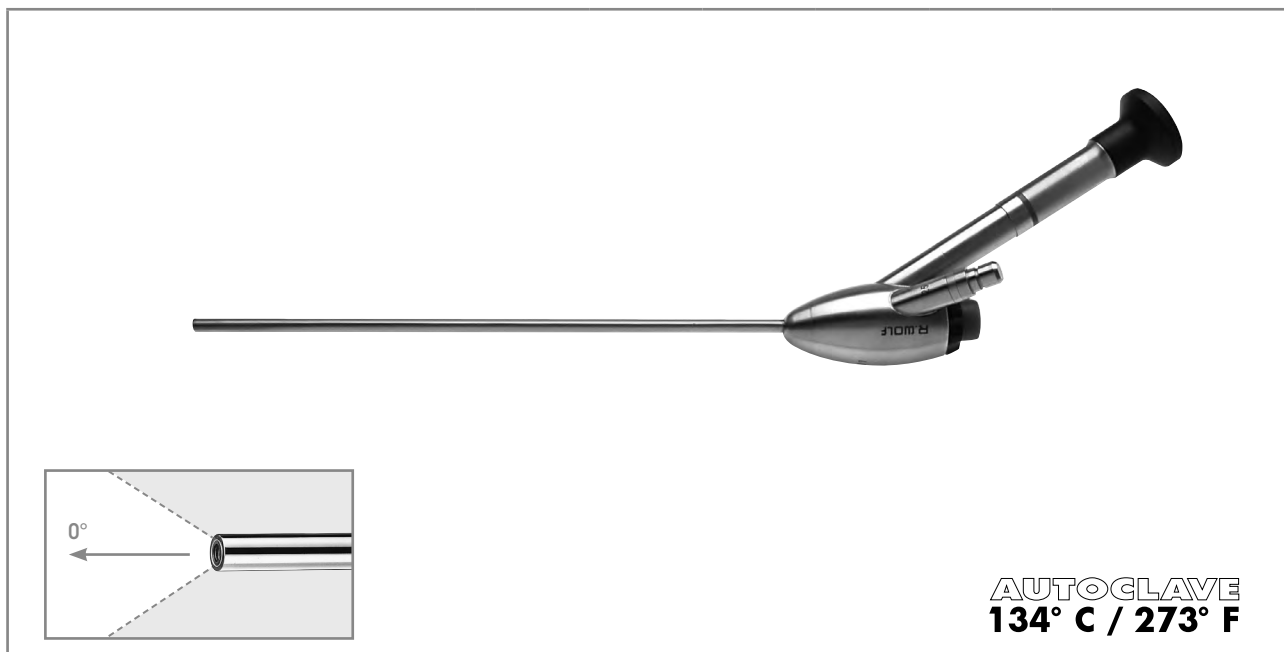

|   | Direction of view | SL     | TL     | Ø      | Working channel Ø | Product no.      |
|---|-------------------|--------|--------|--------|-------------------|------------------|
| <b>OR endoscope bndl</b><br>consisting of:<br>OR endoscope 0° Ø 5.5 mm SL 215 mm (8920.401)<br>Autom. sealing element ID 5.7 mm (8920.311)<br>Sealing cap, red-orange (15176.020)<br>Sealing membrane Ø 17 mm (PACK= 10 PCS) (89.103) | 0°                | 215 mm | 370 mm | 5.5 mm | 3.5 mm            | <b>8920.4011</b> |

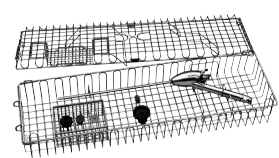
| Recommended accessories   |  | Product no.      |
|---|--|------------------|
| Trocar sleeve, straight, capacity 5.5 mm WL 62 mm   |  | <b>8919.333</b>  |
| Trocar sleeve, straight, capacity 5.5 mm WL 102 mm  |  | <b>8919.353</b>  |
| <b>Perforated basket for telescope</b><br>Dimensions (W x L x H): 132 x 467 x 75 mm   |  | <b>38008</b>     |
| <b>Fiber light cable bndl</b><br>consisting of: Fiber light cable (80663523), projector-side adapter (8095.07), and endoscope-side adapter (809509) | Ø 3.5 mm, 2.3 m long   | <b>806635231</b> |

III23 || Subject to modifications. Please note that some products may not be available in all countries. Please always take note of the information that is provided with the product. For more detailed information, please consult with your contact partner or directly with Richard Wolf GmbH.

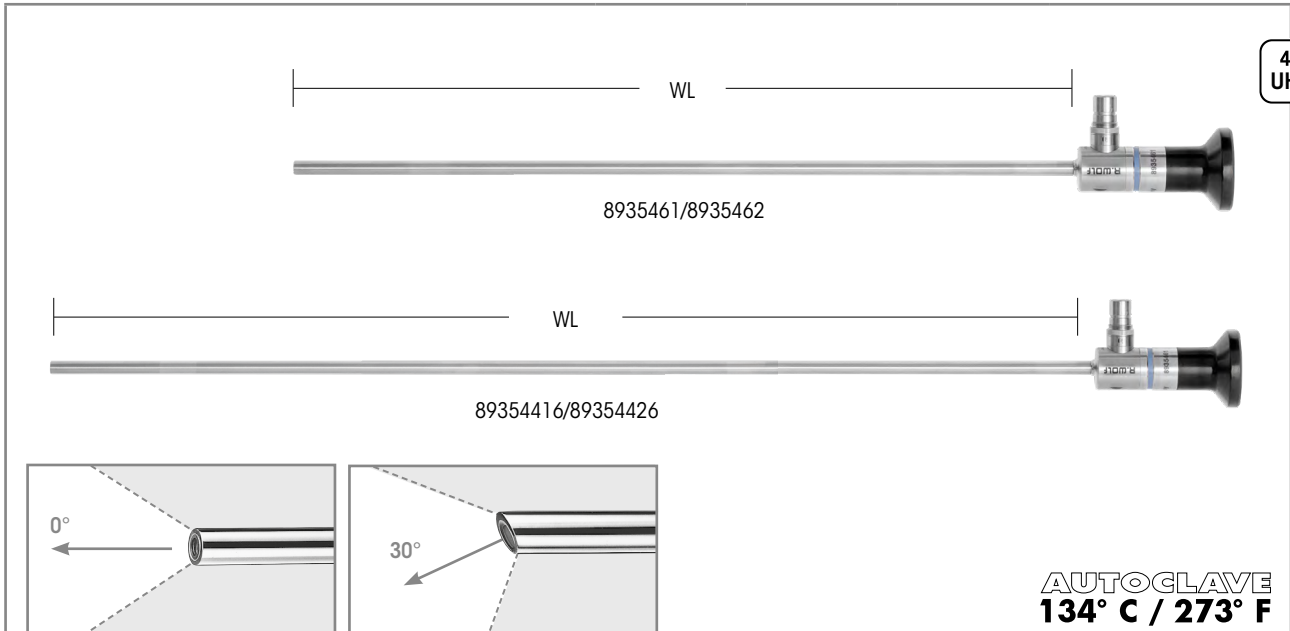

|  | Direction of view | WL     | Ø      | Product no.     |
|--|-------------------|--------|--------|-----------------|
| PANOVIEW ULTRA<br>Telescope Ø 5.5 mm WL 300 mm | 0°                | 300 mm | 5.5 mm | <b>8935461</b>  |
| PANOVIEW ULTRA<br>Telescope Ø 5.5 mm WL 300 mm | 30°               |        |        | <b>8935462</b>  |
| PANOVIEW ULTRA<br>Telescope Ø 5.5 mm WL 430 mm | 0°                | 430 mm |        | <b>89354416</b> |
| PANOVIEW ULTRA<br>Telescope Ø 5.5 mm WL 430 mm | 30°               |        |        | <b>89354426</b> |

| Recommended accessories   |                              | Product no.      |
|---|------------------------------|------------------|
| <b>Perforated basket for standard telescope 2</b><br>(for telescope 8935416/8935426)  | (W x H x D) 481 x 54 x 59 mm | <b>38016</b>     |
| <b>Perforated basket for standard telescope 3</b><br>(for telescope 89354416/89354426)  | (W x H x D) 619 x 54 x 59 mm | <b>38017</b>     |
| <b>Fiber light cable bndl</b><br>consisting of: Fiber light cable (80663523), projector-side adapter (8095.07), and endoscope-side adapter (809509) | Ø 3.5 mm, 2.3 m long         | <b>806635231</b> |

11123 || Subject to modifications. Please note that some products may not be available in all countries. Please always take note of the information that is provided with the product. For more detailed information, please consult with your contact partner or directly with Richard Wolf GmbH.

# LAPAROSCOPES 10 MM

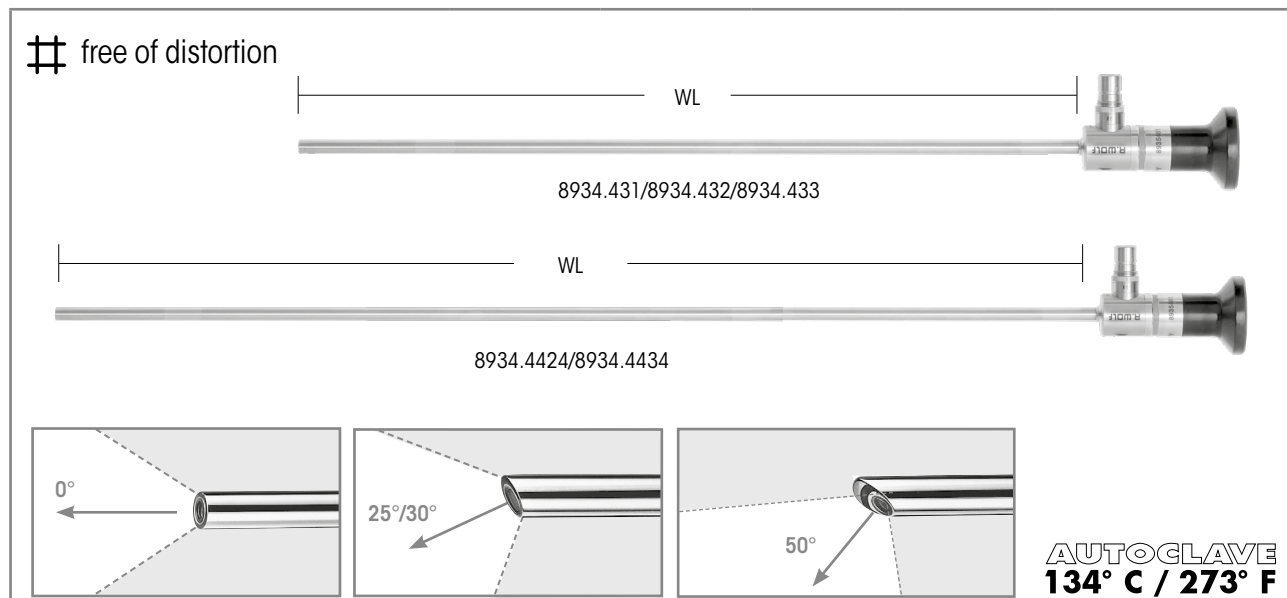

|  | Direction of view | WL     | TL     | Ø     | Product no.      |
|--|-------------------|--------|--------|-------|------------------|
| PANOVIEW<br>Telescope 0° Ø 10 mm WL 307 mm       | 0°                | 307 mm | 375 mm | 10 mm | <b>8934.431</b>  |
| PANOVIEW<br>Telescope 30° Ø 10 mm WL 307 mm      | 30°               | 307 mm | 375 mm |       | <b>8934.432</b>  |
| PANOVIEW<br>Telescope 50° Ø 10 mm WL 310 mm      | 50°               | 310 mm | 378 mm |       | <b>8934.433</b>  |
| PANOVIEW PLUS<br>Telescope 25° Ø 10 mm WL 438 mm | 25°               | 438 mm | 507 mm |       | <b>8934.4424</b> |
| PANOVIEW PLUS<br>Telescope 50° Ø 10 mm WL 447 mm | 50°               | 447 mm | 516 mm |       | <b>8934.4434</b> |

| Recommended accessories  |                              | Product no.      |
|--|------------------------------|------------------|
| <b>Perforated basket for standard telescope 2</b><br>(for telescope 8934.431/.432/.433)  | (W x H x D) 481 x 54 x 59 mm | <b>38016</b>     |
| <b>Perforated basket for standard telescope 3</b><br>(for telescope 8934.4424/.4434)   | (W x H x D) 619 x 54 x 59 mm | <b>38017</b>     |
| <b>Fiber lightcable bndl</b> consisting of:<br>Fiber light cable Ø 5 mm TL 2.3 m (80665023), projector-side adapter (8095.07), and endoscope-side adapter (809509)         | Ø 5.0 mm, 2.3 m long         | <b>806650231</b> |
| <b>Fusion Fiber light cable bndl</b> consisting of:<br>Fiber light cable Ø 5 mm TL 2.3 m (80655023), projector-side adapter (8095.07), and endoscope-side adapter (809509) | Ø 5.0 mm, 2.3 m long         | <b>806550231</b> |

III23 || Subject to modifications. Please note that some products may not be available in all countries. Please always take note of the information that is provided with the product. For more detailed information, please consult with your contact partner or directly with Richard Wolf GmbH.

# 3D ENDOSCOPE 10 MM

# free of distortion

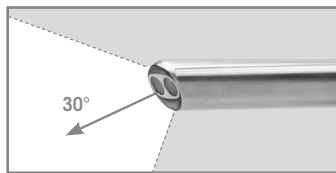
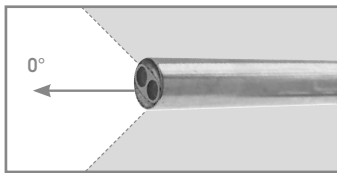
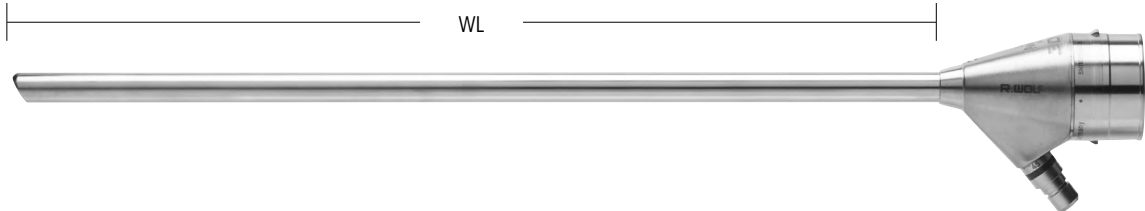

**AUTOCLAVE**  
**134° C / 273° F**

|   | Direction of view | WL     | TL     | Ø     | Product no.     |
|---|-------------------|--------|--------|-------|-----------------|
| <b>3D endoscope 0° Ø 10 mm WL 300 mm</b>  | 0°                | 300 mm | 366 mm | 10 mm | <b>8934631</b>  |
| <b>3D endoscope 0° Ø 10 mm WL 435 mm</b>  |                   | 435 mm | 500 mm |       | <b>89344631</b> |
| <b>3D endoscope 30° Ø 10 mm WL 301 mm</b> | 30°               | 301 mm | 366 mm |       | <b>8934632</b>  |
| <b>3D endoscope 30° Ø 10 mm WL 435 mm</b> |                   | 435 mm | 501 mm |       | <b>89344632</b> |

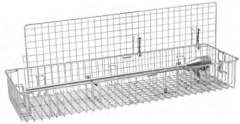
| Recommended accessories  |                                | Product no.      |
|--|--------------------------------|------------------|
| <b>Perforated basket for 3D telescope</b>   | (W x H x D): 583 x 200 x 80 mm | <b>38014</b>     |
| Fusion<br><b>Fiber light cable bndl</b> consisting of:<br>Fiber light cable Ø 5 mm TL 2.3 m (80655023), projector-side, adapter (8095.07), and endoscope-side adapter (809509) | Ø 5.0 mm, 2.3 m long           | <b>806550231</b> |

||123 || Subject to modifications. Please note that some products may not be available in all countries. Please always take note of the information that is provided with the product. For more detailed information, please consult with your contact partner or directly with Richard Wolf GmbH.

# SURGICAL LAPAROSCOPE 10 MM

## FOR ONE HOLE APPENDECTOMY

TELESCOPES

2

# free of distortion

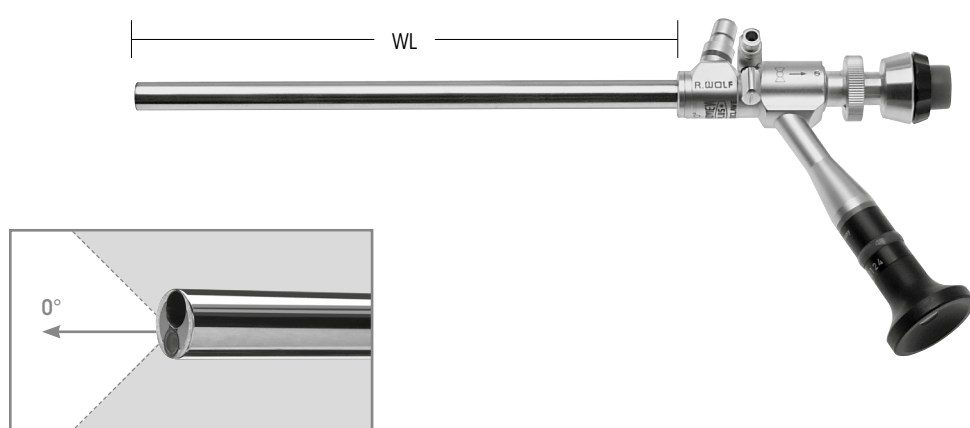

**AUTOCLAVE**  
**134° C / 273° F**

|   | Direction of view | WL     | TL     | Ø     | Working channel Ø | Product no.     |
|---|-------------------|--------|--------|-------|-------------------|-----------------|
| <b>PANOVIEW PLUS</b><br><b>OR endoscope 0° Ø 10 mm WL 188 mm</b><br><br>with lateral eyepiece | 0°                | 188 mm | 285 mm | 10 mm | 5.1 mm            | <b>8915.501</b> |

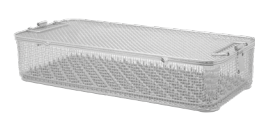
| Recommended accessories  |  | Product no.      |
|--|--|------------------|
| <b>Universal perforated basket 4</b><br>(W x H x D): 538 x 117 x 250 mm  |  | <b>33004</b>     |
| for this:<br><b>Instrument mat for perforated basket</b>   |  | <b>33001</b>     |
| <b>Fiber light cable bndl</b><br>consisting of:<br>Fiber light cable Ø 5 mm TL 2.3 m (80655023),<br>projector-side adapter (8095.07), and endoscope-side adapter (809509)        | Ø 5.0 mm, 2.3 m long   | <b>806650231</b> |
| Fusion<br><b>Fiber light cable bndl</b> consisting of:<br>Fiber light cable Ø 5 mm TL 2.3 m (80655023),<br>projector-side adapter (8095.07), and endoscope-side adapter (809509) | Ø 5.0 mm, 2.3 m long   | <b>806550231</b> |

III23 || Subject to modifications. Please note that some products may not be available in all countries. Please always take note of the information that is provided with the product. For more detailed information, please consult with your contact partner or directly with Richard Wolf GmbH.



**AUTOCLAVE**  
**134° C / 273° F**



|   | Direction of view | WL     | TL     | Ø     | Product no. |
|---|-------------------|--------|--------|-------|-------------|
| PANOVIEW ULTRA<br>Telescope 0° Ø 10 mm WL 305 mm  | 0°                | 305 mm | 375 mm | 10 mm | 8934461     |
| PANOVIEW ULTRA<br>Telescope 30° Ø 10 mm WL 305 mm | 30°               |        |        |       | 8934462     |
| PANOVIEW ULTRA<br>Telescope 50° Ø 10 mm WL 305 mm | 50°               |        |        |       | 8934463     |

4K  
UHD

ICG  
NIR

**Note:** Compatible with System green (see Imaging Catalog) (ICG/NIR-capable) and its recommended Fusion fiber light cable

| Recommended accessories   |                              | Product no.      |
|---|------------------------------|------------------|
| <b>Perforated basket for standard telescope 2</b>   | (W x H x D) 481 x 54 x 59 mm | <b>38016</b>     |
| <b>Fiber lightcable bndl</b> consisting of:<br>Fiber light cable Ø 5 mm TL 2.3 m (80665023), projector-side adapter (8095.07), and endoscope-side adapter (809509)        | Ø 5.0 mm, 2.3 m long         | <b>806650231</b> |
| <b>Fusion fiber lightcable bndl</b> consisting of:<br>Fiber light cable Ø 5 mm TL 2.3 m (80655023), projector-side adapter (8095.07), and endoscope-side adapter (809509) | Ø 5.0 mm, 2.3 m long         | <b>806550231</b> |

11123 || Subject to modifications. Please note that some products may not be available in all countries. Please always take note of the information that is provided with the product. For more detailed information, please consult with your contact partner or directly with Richard Wolf GmbH.



**AUTOCLAVE**  
**134° C / 273° F**



|   | Direction of view | WL     | TL     | Ø     | Product no.     |
|---|-------------------|--------|--------|-------|-----------------|
| PANOVIEW ULTRA<br>Telescope 0° Ø 10 mm WL 440 mm  | 0°                | 440 mm | 510 mm | 10 mm | <b>89344416</b> |
| PANOVIEW ULTRA<br>Telescope 30° Ø 10 mm WL 440 mm | 30°               |        |        |       | <b>89344426</b> |
| PANOVIEW ULTRA<br>Telescope 50° Ø 10 mm WL 440 mm | 50°               |        |        |       | <b>89344436</b> |

**Note:** Compatible with System green (see Imaging Catalog) (ICG/NIR-capable) and its recommended Fusion fiber light cable

| Recommended accessories   |                              | Product no.      |
|---|------------------------------|------------------|
| <b>Perforated basket for standard telescope 3</b>   | (W x H x D) 619 x 54 x 59 mm | <b>38017</b>     |
| <b>Fiber lightcable bndl</b> consisting of:<br>Fiber light cable Ø 5 mm TL 2.3 m (80665023), projector-side adapter (8095.07), and endoscope-side adapter (809509)            | Ø 5.0 mm, 2.3 m long         | <b>806650231</b> |
| Fusion<br><b>Fiber light cable bndl</b> consisting of:<br>Fiber light cable Ø 5 mm TL 2.3 m (80655023), projector-side adapter (8095.07), and endoscope-side adapter (809509) | Ø 5.0 mm, 2.3 m long         | <b>806550231</b> |

III23 || Subject to modifications. Please note that some products may not be available in all countries. Please always take note of the information that is provided with the product. For more detailed information, please consult with your contact partner or directly with Richard Wolf GmbH.



**LIGHT TUBE FOR MILOS METHOD  
(MINI LESS OPEN SUBLAY METHOD)**



**AUTOCLAVE**  
**134° C / 273° F**



|   |   | Ø     | TL     | Product no.   |
|---|---|-------|--------|---------------|
|  | <p><b>Light tube for MILOS method Ø 10 mm</b><br/>Instrument channel for 5 mm instruments</p> | 10 mm | 200 mm | <b>893420</b> |

| Recommended accessories   | Product no.          |                  |
|---|----------------------|------------------|
| <p><b>Fiber light cable bndl</b> consisting of:<br/>Fiber light cable Ø 5 mm, TL 2.3 m (80665023),<br/>projector-side adapter (8095.07), and endoscope-side adapter (809509)</p>            | Ø 5.0 mm, 2.3 m long | <b>806650231</b> |
| <p>Fusion<br/><b>Fiber light cable bndl</b> consisting of:<br/>Fiber light cable Ø 5 mm, TL 2.3 m (80655023),<br/>projector-side adapter (8095.07), and endoscope-side adapter (809509)</p> | Ø 5.0 mm, 2.3 m long | <b>806550231</b> |
| <p>Sealing cap, sulfur yellow, cap. 1.3 mm</p>  |                      | <b>8934201</b>   |

11123 || Subject to modifications. Please note that some products may not be available in all countries. Please always take note of the information that is provided with the product. For more detailed information, please consult with your contact partner or directly with Richard Wolf GmbH.

LAPAROSCOPES  
ACCESSORIES

|   |                        |   | Product no.    |
|---|------------------------|---|----------------|
|  | <b>Sterile adapter</b> | immersible and autoclavable for changing telescopes | <b>8580.91</b> |

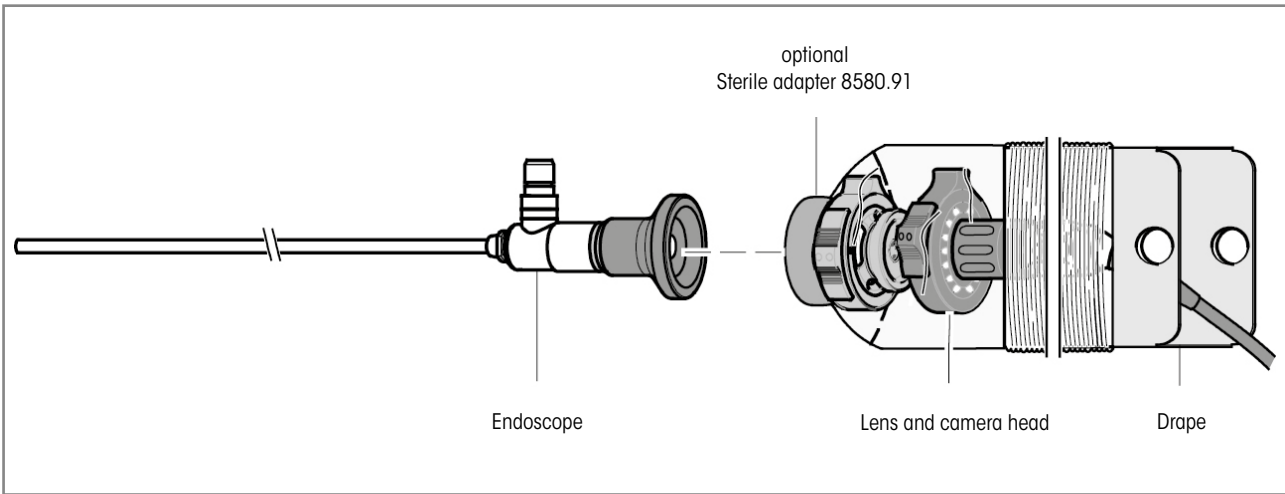

## TROCAR SLEEVES 2.2 / 2.5 MM

|   |           |                 |                    |   |
|---|-----------|-----------------|--------------------|---|
|  |           |                 |                    | Tip<br>triangular                       |
|   |           |                 |                    | Trocar tip<br>triangular<br>Size 2.2 mm |
| <b>Plastic sheath tube with thread</b>  | <b>WL</b> | <b>Capacity</b> | <b>Product no.</b> | WL 82 mm                                |
| Trocar sleeve<br>capacity 2.2 mm WL 60 mm<br>with universal sealing valve         | 60 mm     | 2.2 mm          | <b>8309.072</b>    | <b>8309.121</b>                         |



|  |           |                 |                    |   |
|--|-----------|-----------------|--------------------|---|
| Trocar sleeve<br>with insufflation connector<br><br> |           |                 |                    | Tip<br>triangular                       |
|  |           |                 |                    | Trocar tip<br>triangular<br>Size 2.2 mm |
| <b>Stainless steel sheath tube, smooth</b>   | <b>WL</b> | <b>Capacity</b> | <b>Product no.</b> | WL 82 mm                                |
| Trocar sleeve<br>capacity 2.5 mm WL 95 mm  | 95 mm     | 2.5 mm          | <b>8309.014</b>    | <b>8309.121</b>                         |
|  |           |                 |                    | WL 119 mm                               |
| Trocar sleeve<br>capacity 2.5 mm WL 95 mm  | 95 mm     | 2.5 mm          | <b>8309.014</b>    | <b>8309.123</b>                         |

|   |                    |
|---|--------------------|
| <b>Accessories</b>                            | <b>Product no.</b> |
| Rubber cap capacity 0.8 mm (PACK= 10 PCS) red | <b>88.01</b>       |

11123 || Subject to modifications. Please note that some products may not be available in all countries. Please always take note of the information that is provided with the product. For more detailed information, please consult with your contact partner or directly with Richard Wolf GmbH.

# TROCAR SLEEVES 3.5 MM

## WITH INSUFFLATION STOPCOCK









|  |  |        |          |   |   |   |  |
|--|--|--------|----------|---|---|---|--|
| <b>RIWO-ART trocar sleeves</b><br>with magnetic ball valve<br>with insufflation stopcock |  |        |          |  |   | <b>Tip tapered/blunt</b><br> | <b>Tip triangular</b><br> |
|  |  |        |          | <b>Trocar tip blunt</b><br>Size 3.5 mm  | <b>Trocar tip triangular</b><br>Size 3.5 mm |   |  |
| Stainless steel sheath tube, smooth  |  | WL     | Capacity | <b>Product no.</b>  | WL 169 mm                                   | WL 169 mm   |  |
| <b>Trocar sleeve straight</b><br>capacity 3.5 mm WL 100 mm                               |  | 100 mm | 3.5 mm   | <b>8903.014</b>   | <b>8903.103</b>                             | <b>8903.123</b>   |  |
| Plastic sheath tube with thread  |  |        |          |   |   |   |  |
| <b>Trocar sleeve straight</b><br>capacity 3.5 mm WL 100 mm                               |  | 100 mm | 3.5 mm   | <b>8903.034</b>   | <b>8903.103</b>                             | <b>8903.123</b>   |  |
|  |  |        |          |   | WL 129 mm                                   | WL 129 mm   |  |
| <b>Trocar sleeve slanted</b><br>capacity 3.5 mm WL 60 mm                                 |  | 60 mm  | 3.5 mm   | <b>8903.072</b>   | <b>8903.101</b>                             | <b>8903.121</b>   |  |

| Accessories   | Product no.     |
|---|-----------------|
| Spare ball capacity 5.5 mm  | <b>8921.901</b> |
| Spare O rings capacity 3.5 mm (PACK= 10 PCS), capacity Ø 3.5–5.5 mm | <b>8921.951</b> |
| Sealing cap capacity 2.4–3.4 mm (PACK= 10 PCS) red                  | <b>89.01</b>    |
| Stopcock insert bndl cap. 3.0 mm (PACK= 5 PCS)                      | <b>896.0002</b> |

|   |  |       |          |   |                 |   |
|---|--|-------|----------|---|-----------------|---|
| <b>Trocar sleeve</b><br>with membrane valve               |  |       |          |  |                 | <b>Tip tapered/blunt</b><br> |
|   |  |       |          | <b>Trocar tip blunt</b><br>Size 3.5 mm  |                 |   |
| Plastic sheath tube with distal screw anchor              |  | WL    | Capacity | <b>Product no.</b>  | WL 169 mm       |   |
| <b>Trocar sleeve straight</b><br>capacity 3.5 mm WL 40 mm |  | 40 mm | 3.5 mm   | <b>8929.223</b>   | <b>8903.103</b> |   |

III23 || Subject to modifications. Please note that some products may not be available in all countries. Please always take note of the information that is provided with the product. For more detailed information, please consult with your contact partner or directly with Richard Wolf GmbH.









# TROCAR SLEEVES 5.5 MM

| <b>RIWO-ART trocar sleeves</b><br>with magnetic ball valve<br>with insufflation stopcock<br>    |           |                 |                    | Tip tapered/blunt               | Tip tapered/<br>pointed           | Tip triangular                       |
|--|-----------|-----------------|--------------------|---------------------------------|-----------------------------------|--------------------------------------|
|  |           |                 |                    | Trocar tip blunt<br>Size 5.5 mm | Trocar tip pointed<br>Size 5.5 mm | Trocar tip triangular<br>Size 5.5 mm |
| <b>Stainless steel sheath tube</b>   | <b>WL</b> | <b>Capacity</b> | <b>Product no.</b> | <b>WL 169 mm</b>                | <b>WL 169 mm</b>                  | <b>WL 169 mm</b>                     |
| <b>Trocar sleeve straight capacity 5.5 mm</b><br>WL 100 mm<br>smooth<br>                        | 100 mm    | 5.5 mm          | <b>8921.014</b>    | <b>8921.103</b>                 | <b>8921.113</b>                   | <b>8921.123</b>                      |
| <b>Trocar sleeve slanted capacity 5.5 mm</b><br>WL 100 mm<br>smooth<br>                         | 100 mm    | 5.5 mm          | <b>8921.013</b>    | <b>8921.103</b>                 | <b>8921.113</b>                   | <b>8921.123</b>                      |
| <b>Trocar sleeve straight capacity 5.5 mm</b><br>WL 100 mm<br>with thread<br>                 | 100 mm    | 5.5 mm          | <b>8921.024</b>    | <b>8921.103</b>                 | <b>8921.113</b>                   | <b>8921.123</b>                      |
| <b>Trocar sleeve slanted capacity 5.5 mm</b><br>WL 100 mm<br>with thread<br>                  | 100 mm    | 5.5 mm          | <b>8921.023</b>    | <b>8921.103</b>                 | <b>8921.113</b>                   | <b>8921.123</b>                      |
| Plastic tube<br><b>Trocar sleeve straight capacity 5.5 mm</b><br>WL 100 mm<br>with thread<br> | 100 mm    | 5.5 mm          | <b>8921.034</b>    | <b>8921.103</b>                 | <b>8921.113</b>                   | <b>8921.123</b>                      |
|  |           |                 |                    | <b>WL 219 mm</b>                | <b>WL 219 mm</b>                  | <b>WL 219 mm</b>                     |
| <b>Trocar sleeve straight capacity 5.5 mm</b><br>WL 150 mm<br>smooth<br>                      | 150 mm    | 5.5 mm          | <b>8921.016</b>    | <b>8921.105</b>                 | <b>8921.115</b>                   | <b>8921.125</b>                      |
| <b>Trocar sleeve straight capacity 5.5 mm</b><br>WL 150 mm<br>with thread<br>                 | 150 mm    | 5.5 mm          | <b>8921.026</b>    | <b>8921.105</b>                 | <b>8921.115</b>                   | <b>8921.125</b>                      |

| <b>Accessories</b>   | <b>Product no.</b> |
|--|--------------------|
| <b>Spare ball capacity 5.5 mm</b>  | <b>8921.901</b>    |
| <b>Spare O rings capacity 3.5 mm (PACK= 10 PCS), capacity Ø 3.5–5.5 mm</b> | <b>8921.951</b>    |
| <b>Sealing cap capacity 3.4–5.1 mm (PACK= 10 PCS) blue</b>                 | <b>89.02</b>       |
| <b>Stopcock insert bndl cap. 3.0 mm (PACK= 5 PCS)</b>                      | <b>896.0002</b>    |

1123 || Subject to modifications. Please note that some products may not be available in all countries. Please always take note of the information that is provided with the product. For more detailed information, please consult with your contact partner or directly with Richard Wolf GmbH.

# TROCAR SLEEVES 5.5 MM





| RIWO-ART trocar sleeves<br>with magnetic ball valve<br><br>                             |        |          |             | Tip tapered/blunt               | Tip tapered/<br>pointed           | Tip triangular                       |
|--|--------|----------|-------------|---------------------------------|-----------------------------------|--------------------------------------|
|  |        |          |             | Trocar tip blunt<br>Size 5.5 mm | Trocar tip pointed<br>Size 5.5 mm | Trocar tip triangular<br>Size 5.5 mm |
| Stainless steel sheath tube  | WL     | Capacity | Product no. | WL 129 mm                       | WL 129 mm                         | WL 129 mm                            |
| Trocar sleeve straight capacity 5.5 mm<br>WL 60 mm<br>smooth<br>                        | 60 mm  | 5.5 mm   | 8921.052    | 8921.101                        | 8921.111                          | 8921.121                             |
| Trocar sleeve slanted capacity 5.5 mm<br>WL 60 mm<br>smooth<br>                         | 60 mm  | 5.5 mm   | 8921.051    | 8921.101                        | 8921.111                          | 8921.121                             |
| Trocar sleeve straight capacity 5.5 mm<br>WL 60 mm<br>with thread<br>                 | 60 mm  | 5.5 mm   | 8921.062    | 8921.101                        | 8921.111                          | 8921.121                             |
| Trocar sleeve slanted capacity 5.5 mm<br>WL 60 mm<br>with thread<br>                  | 60 mm  | 5.5 mm   | 8921.061    | 8921.101                        | 8921.111                          | 8921.121                             |
| Plastic tube<br>Trocar sleeve straight capacity 5.5 mm<br>WL 60 mm<br>with thread<br> | 60 mm  | 5.5 mm   | 8921.072    | 8921.101                        | 8921.111                          | 8921.121                             |
|  |        |          |             | WL 169 mm                       | WL 169 mm                         | WL 169 mm                            |
| Trocar sleeve straight capacity 5.5 mm<br>WL 100 mm<br>smooth<br>                     | 100 mm | 5.5 mm   | 8921.054    | 8921.103                        | 8921.113                          | 8921.123                             |
| Trocar sleeve straight capacity 5.5 mm<br>WL 100 mm<br>with thread<br>                | 100 mm | 5.5 mm   | 8921.053    | 8921.103                        | 8921.113                          | 8921.123                             |

| Accessories   | Product no. |
|---|-------------|
| Spare ball capacity 5.5 mm  | 8921.901    |
| Spare O rings capacity 3.5 mm (PACK= 10 PCS), capacity Ø 3.5–5.5 mm | 8921.951    |
| Sealing cap capacity 3.4–5.1 mm (PACK= 10 PCS) blue                 | 89.02       |

# TROTEC

## TROCAR WITH AUTOMATIC PROTECTIVE FUNCTION

### FOR TROCAR SLEEVES 5.5 MM

| Trocar consisting of:                            |   | Product no. | for RIWO-ART trocar sleeve with<br>WL 100 mm, Ø 5,5 mm                               |
|--|---|-------------|--|
| Sheath with trocar tip<br>Size 5.5 mm WL 181 mm  | <b>Tapered tip</b><br>     | 8921.132    |  |
| Sheath with trocar tip<br>Size 5.5 mm WL 181 mm  | <b>Two-sided tip</b><br> | 8921.134    |  |
| <b>Spring-loaded protective rod</b><br>WL 184 mm |                          | 8923.135    |  |

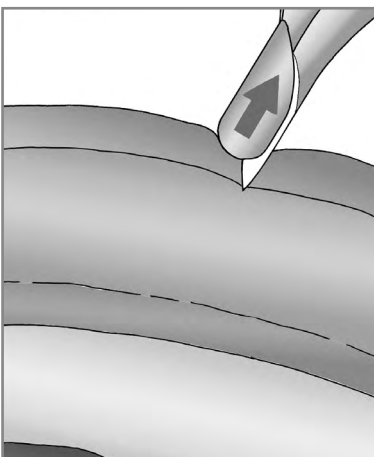

Protective tip automatically pushes back into the cannula through contact with the abdominal wall

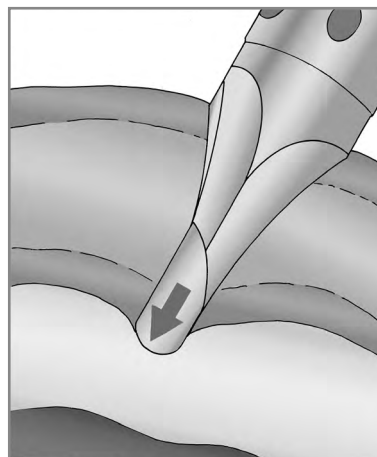

The protective tip advances into the free abdomen immediately after penetration of the peritoneum

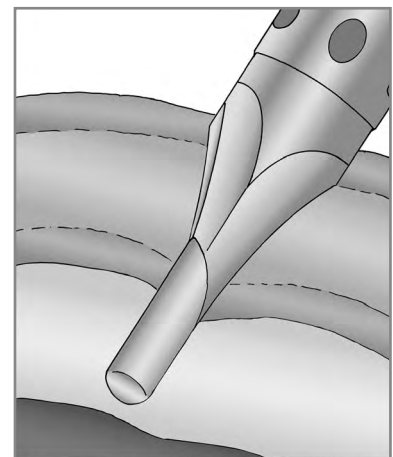





The atraumatic protective tip in a far distal position prevents perforation of organs and vessels





# TROCAR SLEEVE 5.5 MM/5.8 MM

PLASTIC WITH SEALING MEMBRANE

TROCAR SLEEVES

3

|  |        |          |               |             |  |   |   |
|--|--------|----------|---------------|-------------|--|---|---|
|  <p><b>AUTOCLAVE</b><br/><b>134° C / 273° F</b></p> |        |          |               |             | Tip tapered/blunt  | Tip tapered/pointed   | Tip triangular  |
|  |        |          |               |             |  |  |  |
|  |        |          |               |             | Trocar tip blunt<br>Size 5.5 mm  | Trocar tip pointed<br>Size 5.5 mm   | Trocar tip triangular<br>Size 5.5 mm  |
| Flexible plastic sheath tube with thread   | WL     | Capacity | with stopcock | Product no. | WL 104 mm  | WL 104 mm   | WL 104 mm   |
| Trocar sleeve straight<br>capacity 5.5 mm WL 62 mm<br>with membrane valve  | 62 mm  | 5.5 mm   | ●             | 8919.333    | 8919.3311  | 8919.3312   | 8919.3313   |
|  |        |          |               | 8919.331    |  |   |   |
|  |        |          |               |             | WL 144 mm  | WL 144 mm   | WL 144 mm   |
| Trocar sleeve straight<br>capacity 5.5 mm WL 102 mm<br>with membrane valve   | 102 mm | 5.5 mm   | ●             | 8919.353    | 8919.3511  | 8919.3512   | 8919.3513   |
|  |        |          |               | 8919.351    |  |   |   |

|  |        |          |             |   |  |   |   |
|--|--------|----------|-------------|---|--|---|---|
| for curved instruments   |        |          |             | Tip tapered/blunt   | Tip tapered/pointed  | Tip triangular  | Tip tapered/blunt   |
|  <p><b>AUTOCLAVE</b><br/><b>134° C / 273° F</b></p> |        |          |             |  |  |  |  |
|  |        |          |             | Trocar tip blunt<br>Size 5.5 mm   | Trocar tip pointed<br>Size 5.5 mm  | Trocar tip triangular<br>Size 5.5 mm  | Trocar tip blunt<br>Size 5.5 mm   |
| Flexible plastic sheath tube with thread   | WL     | Capacity | Product no. | WL 80 mm  | WL 80 mm   | WL 80 mm  | WL 80 mm  |
| Trocar sleeve straight<br>capacity 5.8 mm WL 62 mm<br>with membrane valve  | 62 mm  | 5.8 mm   | 8905.331    | 8905.3311   | 8905.3312  | 8905.3313   | 8905.3315   |
|  |        |          |             |   |  |   |   |
|  |        |          |             | WL 120 mm   | WL 120 mm  | WL 120 mm   | WL 120 mm   |
| Trocar sleeve straight<br>capacity 5.8 mm WL 102 mm<br>with membrane valve   | 102 mm | 5.8 mm   | 8905.3515   | 8905.3511   | 8905.3512  | 8905.3513   | 8905.3515   |
|  |        |          |             |   |  |   |   |

| Accessories                                     | Product no. |
|---|-------------|
| Sealing membrane Ø 17 mm, yellow (PACK= 10 PCS) | 89.103      |
| Stopcock insert bndl cap 3.0 mm (PACK= 5 PCS)   | 896.0002    |

11123 || Subject to modifications. Please note that some products may not be available in all countries. Please always take note of the information that is provided with the product. For more detailed information, please consult with your contact partner or directly with Richard Wolf GmbH.



# TROCAR SLEEVE 5.7 MM/7 MM/10 MM/12.5 MM









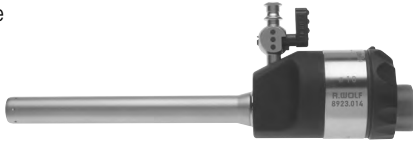

## FLEXIBLE PLASTIC SHEATH TUBE

|   |       |          |             |                      |
|---|-------|----------|-------------|----------------------|
|  |       |          |             | Tip tapered/blunt    |
|   |       |          |             | Trocar tip blunt     |
| Flexible plastic sheath tube with thread  | WL    | Capacity | Product no. | Size 5.5 mm/WL 83 mm |
| Trocar sleeve straight capacity 5.7 mm WL 60 mm with rubber cap                   | 60 mm | 5.7 mm   | 8906.051    | 8906.151             |

|   |       |          |             |                       |
|---|-------|----------|-------------|-----------------------|
|  |       |          |             | Tip tapered/blunt     |
|   |       |          |             | Trocar tip blunt      |
| Ribbed flexible plastic sheath tube   | WL    | Capacity | Product no. | Size 7.3 mm/TL 108 mm |
| Trocar sleeve flexible capacity 7 mm WL 74 mm with universal seal                   | 74 mm | 7 mm     | 8906.001    | 8913.11               |
|   |       |          |             | Size 10 mm/TL 85 mm   |
| Trocar sleeve flexible capacity 10 mm WL 56 mm with universal seal                  | 56 mm | 10 mm    | 8906.011    | 8906.111              |
|   |       |          |             | Size 12.5 mm/TL 86 mm |
| Trocar sleeve flexible capacity 12.5 mm WL 57 mm with universal seal                | 57 mm | 12.5 mm  | 8906.031    | 8906.131              |

# TROCAR SLEEVE 10 MM

## WITH INSUFFLATION STOPCOCK





| RIWO-ART trocar sleeves<br>with magnetic ball valve  |   |        |          |                 | Tip tapered/blunt  | Tip tapered/pointed   | Tip triangular  |
|---|---|--------|----------|-----------------|--|---|---|
|   |   |        |          |                 |  |  |  |
|   |   |        |          |                 | Trocar tip blunt<br>Size 10 mm   | Trocar tip pointed<br>Size 10 mm  | Trocar tip triangular<br>Size 10 mm   |
| Stainless steel sheath tube   |   | WL     | Capacity | Product no.     | WL 164 mm  | WL 164 mm   | WL 164 mm   |
| Trocar sleeve straight<br>capacity 10 mm<br>WL 100 mm   |    | 100 mm | 10 mm    | <b>8923.014</b> | <b>8923.103</b>  | <b>8923.113</b>   | <b>8923.123</b>   |
| Trocar sleeve slanted<br>capacity 10 mm<br>WL 100 mm  |   | 100 mm | 10 mm    | <b>8923.013</b> | <b>8923.103</b>  | <b>8923.113</b>   | <b>8923.123</b>   |
| Trocar sleeve straight<br>capacity 10 mm<br>WL 100 mm<br>with thread  |  | 100 mm | 10 mm    | <b>8923.024</b> | <b>8923.103</b>  | <b>8923.113</b>   | <b>8923.123</b>   |
| Trocar sleeve slanted<br>capacity 10 mm<br>WL 100 mm<br>with thread   |  | 100 mm | 10 mm    | <b>8923.023</b> | <b>8923.103</b>  | <b>8923.113</b>   | <b>8923.123</b>   |
|   |   |        |          |                 | WL 214 mm  | WL 214 mm   | WL 214 mm   |
| Trocar sleeve straight<br>capacity 10 mm<br>WL 150 mm   |  | 150 mm | 10 mm    | <b>8923.016</b> | -  | <b>8923.115</b>   | <b>8923.125</b>   |
| Trocar sleeve straight<br>capacity 10 mm<br>WL 150 mm<br>with thread  |  | 150 mm | 10 mm    | <b>8923.026</b> | -  | <b>8923.115</b>   | <b>8923.125</b>   |

| Accessories  | Product no.     |
|--|-----------------|
| Spare ball capacity 7 mm   | <b>8923901</b>  |
| Spare O rings capacity 7 mm (PACK= 10 PCS), capacity Ø 7–12.5 mm | <b>8923951</b>  |
| Sealing cap capacity 9.5–10.1 mm (PACK= 10 PCS) red              | <b>8908</b>     |
| Stopcock insert bndl cap. 3.0 mm (PACK= 5 PCS)                   | <b>896.0002</b> |

# TROTEC

## TROCAR WITH AUTOMATIC PROTECTIVE FUNCTION

### FOR TROCAR SLEEVES 10 MM

| Trocar consisting of:                          |  | Product no. | for RIWO-ART trocar sleeve with<br>WL 100 mm, ø 10 mm                                |
|--|--|-------------|--|
| Sheath with trocar tip<br>Size 10 mm WL 181 mm | Tapered tip<br>     | 8923.132    |  |
| Sheath with trocar tip<br>Size 10 mm WL 181 mm | Two-sided tip<br> | 8923.134    |  |
| Spring-loaded protective rod<br>WL 184 mm      |                   | 8923.135    |  |

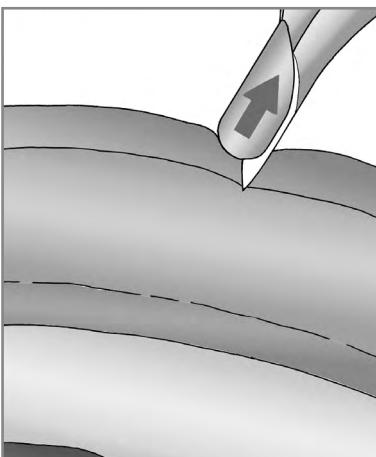

Protective tip automatically pushes back into the cannula through contact with the abdominal wall

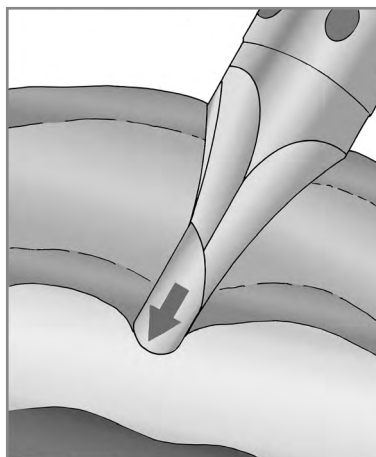

The protective tip advances into the free abdomen immediately after penetration of the peritoneum

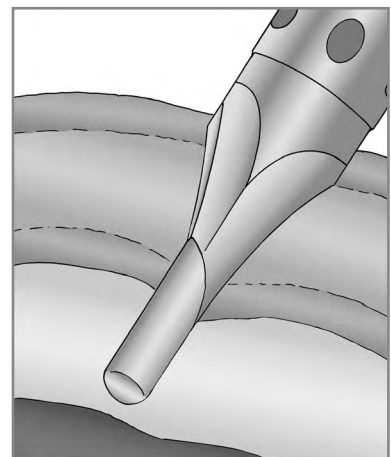



The atraumatic protective tip in a far distal position prevents perforation of organs and vessels

# HIGH FLOW TROCAR SLEEVE 10 MM

## WITH CONNECTOR FOR HIGH FLOW INSUFFLATION TUBE

TROCAR SLEEVES







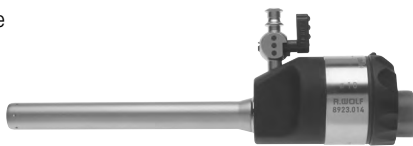

3

|   |  |   |   |  |   |   |                 |                 |
|---|--|---|---|--|---|---|-----------------|-----------------|
| RIWO-ART trocar sleeves with magnetic ball valve<br> |  |   |   | Tip tapered/blunt  | Tip tapered/pointed   | Tip triangular  |                 |                 |
|   |  |   |   |  |  |  |                 |                 |
|   |  |   |   | Trocar tip blunt<br>Size 10 mm   | Trocar tip pointed<br>Size 10 mm  | Trocar tip triangular<br>Size 10 mm   |                 |                 |
| Stainless steel sheath tube   |  | WL  | Capacity  | Product no.  | WL 164 mm   | WL 164 mm   | WL 164 mm       |                 |
| Trocar sleeve straight<br>capacity 10 mm<br>WL 100 mm   |  |    | 100 mm  | 10 mm  | <b>8923.042</b>   | <b>8923.103</b>   | <b>8923.113</b> | <b>8923.123</b> |
| for this:   |  |   |   |  |   | Product no.   |                 |                 |
| Reducing adapter<br>(PACK= 5 PCS)   |  |  | for reduction from<br>Ø 7 mm, Ø 10 mm, and Ø 12.5 mm<br>to Ø 5.5 mm |  |   | <b>8923802</b>  |                 |                 |

| Accessories  | Product no.    |
|--|----------------|
| Spare ball capacity 7 mm   | <b>8923901</b> |
| Spare O rings capacity 7 mm (PACK= 10 PCS), capacity Ø 7–12.5 mm | <b>8923951</b> |
| Sealing cap capacity 9.5–10.1 mm (PACK= 10 PCS) red              | <b>8908</b>    |

11123 || Subject to modifications. Please note that some products may not be available in all countries. Please always take note of the information that is provided with the product. For more detailed information, please consult with your contact partner or directly with Richard Wolf GmbH.

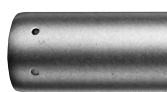
# TROCAR SLEEVE 12.5 MM WITH INSUFFLATION STOPCOCK

|   |  |  |          |   |  |   |                 |
|---|--|--|----------|---|--|---|-----------------|
| RIWO-ART trocar sleeves with magnetic ball valve<br>                         |  |  |          | Tip tapered/blunt<br> | Tip tapered/pointed<br> | Tip triangular<br> |                 |
|   |  |  |          | Trocar tip blunt<br>Size 12.7 mm  | Trocar tip pointed<br>Size 12.7 mm   | Trocar tip triangular<br>Size 12.7 mm   |                 |
| Stainless steel sheath tube   |  | WL   | Capacity | Product no.   | WL 164 mm  | WL 164 mm   | WL 164 mm       |
| Trocar sleeve straight<br>capacity 12.5 mm<br>WL 100 mm<br>                  |  | 100 mm   | 12.5 mm  | <b>8924.014</b>   | <b>8924.103</b>  | <b>8924.113</b>   | <b>8924.123</b> |
| Trocar sleeve slanted<br>capacity 12.5 mm<br>WL 100 mm<br>                  |  | 100 mm   | 12.5 mm  | <b>8924.013</b>   | <b>8924.103</b>  | <b>8924.113</b>   | <b>8924.123</b> |
|   |  |  |          |   | WL 214 mm  | WL 214 mm   | WL 214 mm       |
| Trocar sleeve straight<br>capacity 12.5 mm<br>WL 150 mm<br>with thread<br> |  | 150 mm   | 12.5 mm  | <b>8924.026</b>   | -  | <b>8924.115</b>   | <b>8924.125</b> |
| Trocar sleeve straight<br>capacity 12.5 mm<br>WL 150 mm<br>                |  | 150 mm   | 12.5 mm  | <b>8924.016</b>   | -  | <b>8924.115</b>   | <b>8924.125</b> |
| for this:   |  |  |          |   |  |   |                 |
| Reducing adapter<br>(PACK= 5 PCS)<br>                                      |  | for reduction from<br>Ø 10 mm to Ø 5.5 mm and<br>Ø 12.5 mm to Ø 5.5 mm |          |   |  | <b>8923.802</b>   |                 |
|   |  | for reduction from<br>Ø 12.5 mm to Ø 10 mm                             |          |   |  | <b>8924.802</b>   |                 |



| Accessories  | Product no.     |
|--|-----------------|
| Spare ball capacity 7 mm   | <b>8923.901</b> |
| Spare O rings capacity 7 mm (PACK= 10 PCS), capacity Ø 7–12.5 mm | <b>8923.951</b> |
| Sealing cap capacity 9.5–10.1 mm (PACK= 10 PCS) red              | <b>89.08</b>    |
| Stopcock insert bndl cap. 3.0 mm (PACK= 5 PCS)                   | <b>896.0002</b> |

11123 || Subject to modifications. Please note that some products may not be available in all countries. Please always take note of the information that is provided with the product. For more detailed information, please consult with your contact partner or directly with Richard Wolf GmbH.

**TROTEC**  
**TROCAR WITH AUTOMATIC PROTECTIVE FUNCTION**  
 FOR TROCAR SLEEVES 12.5 MM

TROCAR SLEEVES

3

|  |  |             |   |
|--|--|-------------|---|
| Trocar consisting of:                            |  | Product no. | for RIWO-ART trocar sleeve with<br>WL 100 mm, Ø 12,5 mm                             |
| Sheath with trocar tip<br>Size 12.5 mm WL 181 mm | Two-sided tip<br> | 8924.134    |  |
| Spring-loaded protective rod<br>WL 184 mm        |                 | 8923.135    |   |

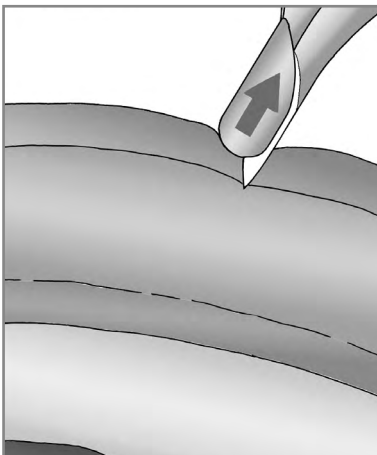

Protective tip automatically pushes back into the cannula through contact with the abdominal wall

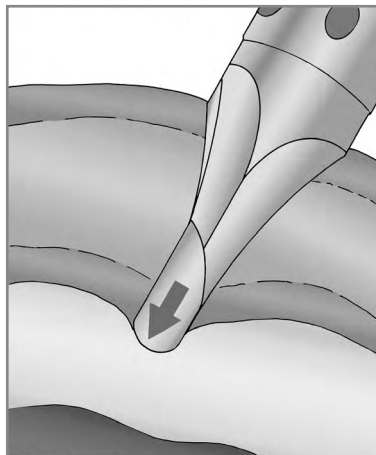

The protective tip advances into the free abdomen immediately after penetration of the peritoneum

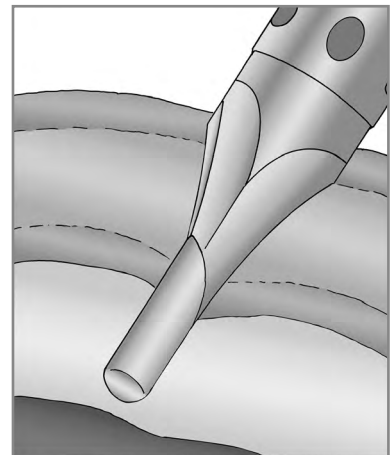

The atraumatic protective tip in a far distal position prevents perforation of organs and vessels

III23 || Subject to modifications. Please note that some products may not be available in all countries. Please always take note of the information that is provided with the product. For more detailed information, please consult with your contact partner or directly with Richard Wolf GmbH.

# DILATATION AND EXTRACTION INSTRUMENTS

## 5.5 TO 10/10 TO 12.5 MM

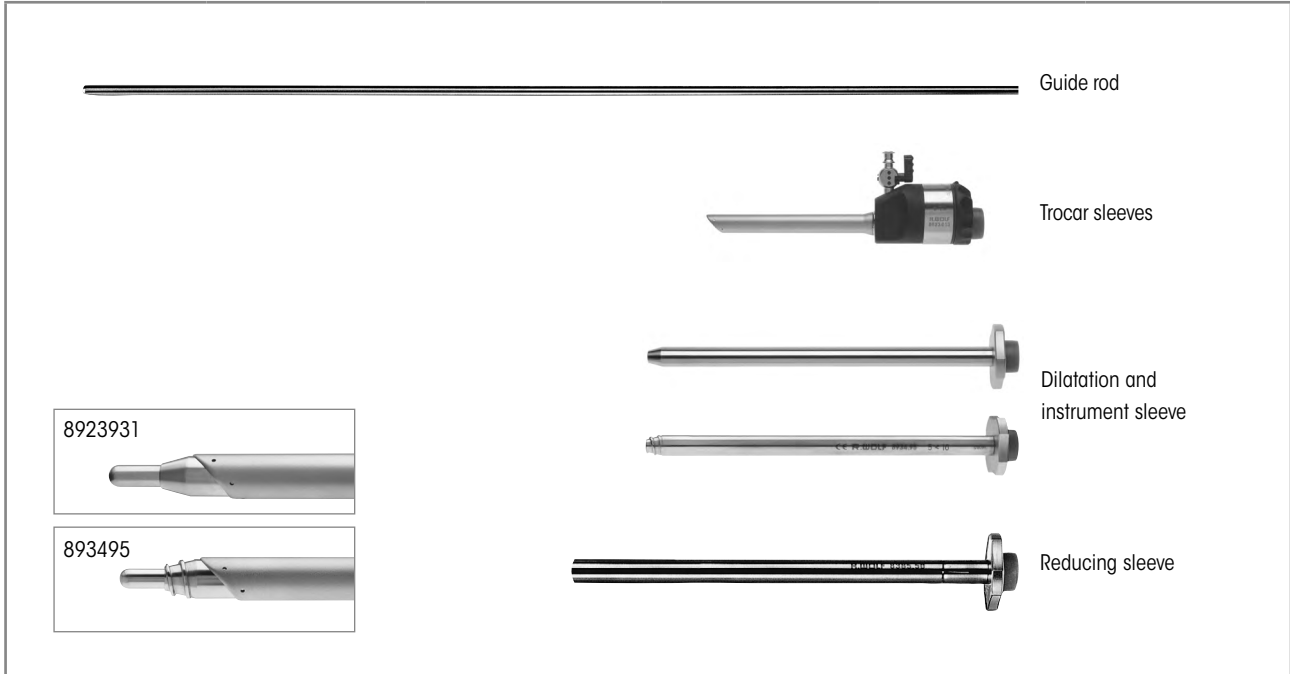

| Incision widening | Guide rod                           | Trocar sleeve slanted                            | Dilatation sleeve                          | Instrument sleeve                 | Reducing sleeve                      |
|-------------------|-------------------------------------|--|--|-----------------------------------|--------------------------------------|
| 3.5 mm < 5.5 mm   | -                                   | <b>8921.013</b><br>capacity 5.5 mm WL<br>100 mm  |  |                                   | <b>8383.78</b><br>Size 5 mm L 155 mm |
| 5.5 mm < 10 mm    | <b>8923.921</b><br>5.5 mm TL 500 mm | <b>8923.013</b><br>capacity 10 mm WL<br>100 mm   | <b>8923.931</b><br>Size 10 mm WL<br>170 mm | <b>8385.50</b><br>10 mm WL 170 mm |                                      |
| 5.0 mm < 10 mm    | <b>8934.951</b><br>5 mm TL 500 mm   |  | <b>8934.95</b><br>Size 10 mm WL<br>172 mm  |                                   |                                      |
| 10 mm < 12.5 mm   |                                     | <b>8924.013</b><br>capacity 12.5 mm WL<br>100 mm |  |                                   | <b>8941.901</b><br>12 mm WL 180 mm   |
| 5.5 mm < 12.5 mm  |                                     |  |  |                                   | <b>8941.951</b><br>12 mm WL 180 mm   |
| 10 mm < 15 mm     | <b>8943.901</b><br>10 mm TL 500 mm  |  |  |                                   |                                      |

11123 || Subject to modifications. Please note that some products may not be available in all countries. Please always take note of the information that is provided with the product. For more detailed information, please consult with your contact partner or directly with Richard Wolf GmbH.

## REDUCING SLEEVES FOR RIWO-ART TROCAR SLEEVES

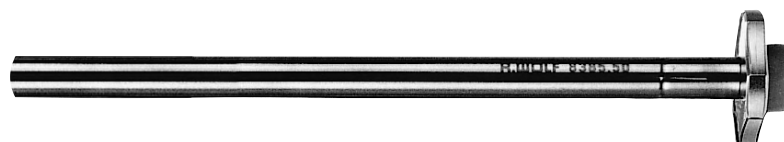



| Stainless steel sheath tube                   | Outer Ø   | WL  | for instruments | Product no.     |
|---|---|---|-----------------|-----------------|
| <b>Reducing sleeve</b><br>Size 5 mm WL 155 mm | 5 mm  | 155 mm  | 3.5 mm          | <b>8383.78</b>  |
| <b>Instrument sleeve</b><br>10 mm WL 170 mm   | 10 mm   | 170 mm  | 5.5 mm          | <b>8385.50</b>  |
| <b>Reducing sleeve</b><br>12 mm WL 180 mm     | 12 mm   | 180 mm  | 10 mm           | <b>8941.901</b> |
| <b>Reducing sleeve</b><br>12 mm WL 180 mm     | 12 mm   | 180 mm  | 5.5 mm          | <b>8941.951</b> |
| for this:                                     |   |   |                 |                 |
| <b>Reducing adapter</b><br>(PACK= 5 PCS)      |  | for reduction from<br>Ø 7 mm, Ø 10 mm, and Ø 12.5 mm<br>to Ø 5.5 mm |                 | <b>8923802</b>  |
|   |   | for reduction from<br>Ø 12.5 mm to Ø 10 mm                          |                 | <b>8924802</b>  |

| Accessories  | Product no.  |
|--|--------------|
| <b>Sealing cap capacity 3.4–5.1 mm (PACK= 10 PCS) blue</b> | <b>89.02</b> |
| <b>Sealing cap capacity 9.5–10.1 mm (PACK= 10 PCS) red</b> | <b>8908</b>  |



# VERES CANNULAS

## FOR CREATION OF THE PNEUMOPERITONEUM

|  |   |               |        |                |
|--|---|---------------|--------|----------------|
|  |   | Outer Ø       | WL     | Product no.    |
|   | VERES cannula Ø 2.1 mm WL 150 mm  | <b>2.1 mm</b> | 150 mm | <b>8302.15</b> |
|  | VERES cannula Ø 2.1 mm WL 152 mm (standard length)                                  |               | 120 mm | <b>8302.12</b> |
|  | VERES cannula Ø 2.1 mm WL 80 mm   |               | 80 mm  | <b>8302.08</b> |
| <b>for this:</b>   |   |               |        |                |
| Tube with Luer-Lock connector  |  |               |        | <b>886.00</b>  |

| Accessories                                    | Product no.     |
|--|-----------------|
| Stopcock insert bndl cap. 3.0 mm (PACK= 5 PCS) | <b>896.0002</b> |

11123 || Subject to modifications. Please note that some products may not be available in all countries. Please always take note of the information that is provided with the product. For more detailed information, please consult with your contact partner or directly with Richard Wolf GmbH.

# ERAGON<sup>modular</sup>

## THE LAPAROSCOPIC TOOLBOX

### The toolbox principle

**ERAGONmodular** allows the surgeon to create their ideal laparoscopic set. Ergonomic handles, diameters relevant to all medical practice, useful working lengths, and a range of jaw sections can be combined as necessary. This universal compatibility also ensures that individual trays can comprise fewer instruments – for more efficiency and one way of cutting costs

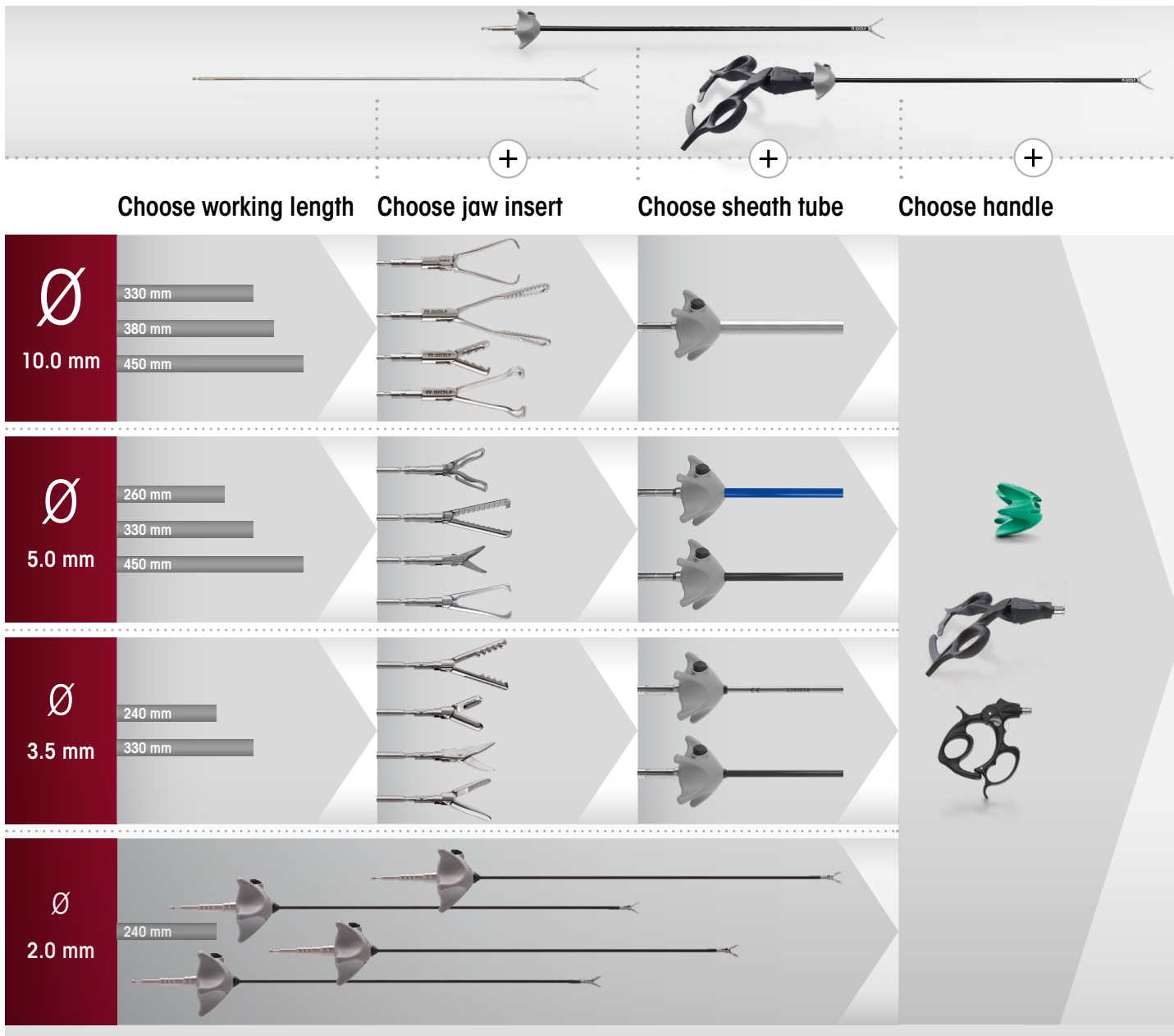

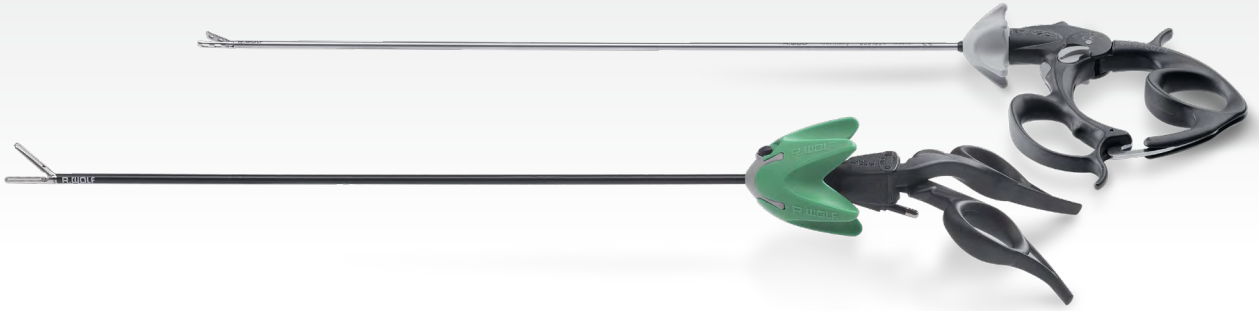



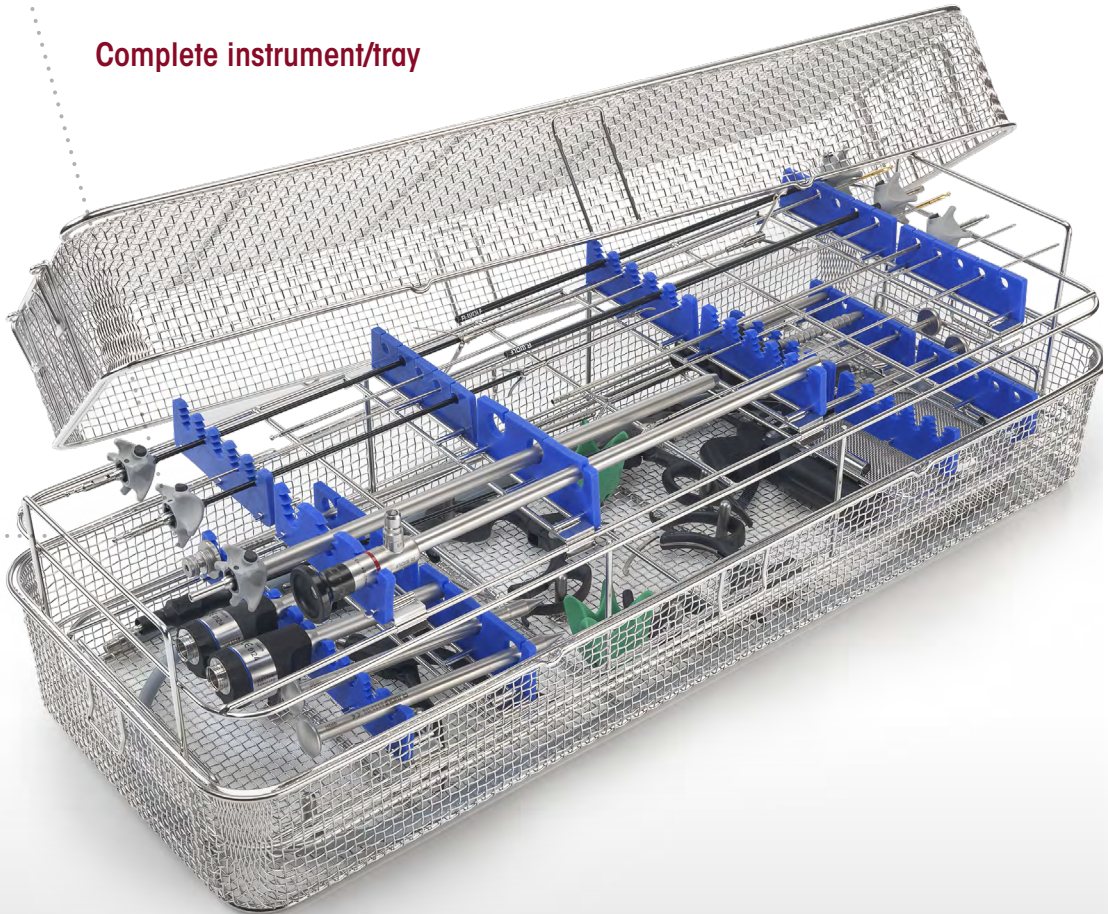





**Complete instrument/tray**







**ERAGON** modular  
micro  
Ø 2 MM, INSULATED

|   |                    | Handle, axial   |   |
|---|--------------------|---|---|
| <b>ERAGON</b> axial   |                    |  |  |
| All jaw inserts and sheath tubes can also be combined with <b>ERAGON</b> axial    |                    | without lock, with HF connector   | without lock, with HF connector   |
| <b>Rotatable knob</b>   | <b>Product no.</b> | 83930083  | 83930084  |
|  | 8988               | •   | •   |

| Jaw insert  |            | Sheath tube, Ø 2.0 mm, insulated  | Handle, pistol-shaped   | Complete instrument   |
|---|------------|---|---|---|
|    |            |  |  | <ul style="list-style-type: none"> <li>• Jaw insert with sheath tube</li> <li>• Handle</li> </ul> |
|   |            | WL 240 mm   | without lock, with HF, mono   |   |
|   | <b>JL*</b> | <b>Product no.</b>  | 83930073  | <b>Product no.</b>  |
| <br>Scissors mono Ø 2 mm bndl<br>straight, double-action                       | 7 mm       | 8388200   | •   | •   |
| <br>Dissector forceps mono Ø 2 mm bndl<br>straight, double-action              | 7 mm       | 8388201   | •   | •   |
| <br>Atraumatic grasping forceps mono Ø 2 mm bndl<br>fenestrated, double-action | 7 mm       | 8388202   | •   | •   |
|   |            |   |   | <b>83882007</b>   |
|   |            |   |   | <b>83882017</b>   |
|   |            |   |   | <b>83882027</b>   |

\* JL = jaw length when jaw section closed (approximate measurements)  
HF connection cable: see sheet BDE116/117

**ERAGON** modular  
micro  
Ø 2 MM, INSULATED

| Jaw insert  |      | Sheath tube, Ø 2.0 mm, insulated  |   | Handle, pistol-shaped   | Complete instrument<br>• Jaw insert with sheath tube<br>• Handle |
|---|------|---|---|---|--|
|    |      |  |   |  |  |
|   |      | WL<br>240 mm  |   | with lock,<br>with HF, mono   |  |
|   | JL*  | Product no.   |   | 83930074  | Product no.  |
| <br>Grasping forceps<br>mono Ø 2 mm bndl<br><br>double-action | 7 mm | 8388203   | • | •   | <b>83882037</b>  |

\* JL = jaw length when jaw section closed (approximate measurements)  
HF connection cable: see sheet BDE116/117

| Accessories for manual and machine reprocessing                                     |  | Product no.   |
|---|--|---------------|
|  | Irrigation adapter<br>Ø 9 mm, length 64 mm | <b>163502</b> |



11123 || Subject to modifications. Please note that some products may not be available in all countries. Please always take note of the information that is provided with the product. For more detailed information, please consult with your contact partner or directly with Richard Wolf GmbH.







**ERAGON** modular mini

Ø 3.5 MM, INSULATED

ERAGONMODULAR

4

|   |                    | Handle, axial   |   |
|---|--------------------|---|---|
| <b>ERAGON</b> axial   |                    |  |  |
| All jaw inserts and sheath tubes can also be combined with <b>ERAGON</b> axial    |                    | without lock, with HF connector   | without lock, with HF connector   |
| <b>Rotatable knob</b>   | <b>Product no.</b> | 83930083  | 83930084  |
|  | 8988               | •   | •   |









| Jaw insert  |       | Sheath tube, Ø 3.5 mm, insulated   |           | Handle, pistol-shaped  | Complete instrument   |                    |
|---|-------|--|-----------|--|---|--------------------|
|   |       |  |           |  | <ul style="list-style-type: none"> <li>• Jaw insert with sheath tube</li> <li>• Handle</li> </ul> |                    |
|   |       | WL 240 mm  | WL 330 mm | with lock, with HF, mono   |   |                    |
|   | JL*   | <b>Product no.</b>   | 8390933   | 8391933  | 83930074  | <b>Product no.</b> |
|  | 15 mm | 8390207  | •         |  | •   | <b>83902077</b>    |
| curved to the left, double-action   |       | 8391207  |           | •  | •   | <b>83912077</b>    |
|  | 18 mm | 8390221  | •         |  | •   | <b>83902217</b>    |
| long, fine tip, double-action   |       | 8391221  |           | •  | •   | <b>83912217</b>    |
|  | 14 mm | 8390222  | •         |  | •   | <b>83902227</b>    |
| short, fine tip, double-action  |       | 8391222  |           | •  | •   | <b>83912227</b>    |
|  | 14 mm | 8390223  | •         |  | •   | <b>83902237</b>    |
| angled, double-action   |       | 8391223  |           | •  | •   | <b>83912237</b>    |

\* JL = jaw length when jaw section closed (approximate measurements)

HF connection cable: see sheet BDE116/117

**ERAGON** modular  
mini

Ø 3.5 MM, INSULATED

| Jaw insert  |     |             | Sheath tube, Ø 3.5 mm, insulated  |         | Handle, pistol-shaped   |          | Complete instrument<br>• Jaw insert with sheath tube<br>• Handle |
|---|-----|-------------|---|---------|---|----------|--|
|    |     |             |  |         |  |          |  |
|   |     |             |   |         |   |          | WL<br>240 mm   |
|   | JL* | Product no. | 8390933   | 8391933 | 83930073  | 83930074 | Product no.  |
| <br>Metzenbaum scissors<br>mono Ø 3.5 mm bndl<br>16 mm<br>double-action                            |     | 8390215     | •   |         | •   |          | 83902157   |
|   |     | 8391215     |   | •       | •   |          | 83912157   |
| <br>Metzenbaum scissors<br>mono Ø 3.5 mm bndl<br>14 mm<br>fine-toothed, curved,<br>double-action |     | 8390224     | •   |         | •   |          | 83902247   |
|   |     | 8391224     |   | •       | •   |          | 83912247   |
| <br>Hook scissors<br>mono Ø 3.5 mm bndl<br>8 mm<br>single-action                                 |     | 8390227     | •   |         | •   |          | 83902277   |
|   |     | 8391227     |   | •       | •   |          | 83912277   |
| <br>Double spoon forceps<br>mono Ø 3.5 mm bndl<br>12 mm  |     | 8390216     | •   |         |   | •        | 83902167   |
|   |     | 8391216     |   | •       |   | •        | 83912167   |
| <br>Friedel punch<br>mono Ø 3.5 mm bndl<br>10 mm   |     | 8390217     | •   |         |   | •        | 83902177   |
|   |     | 8391217     |   | •       |   | •        | 83912177   |

\* JL = jaw length when jaw section closed (approximate measurements)





HF connection cable: see sheet BDE116/117







| Accessories for manual and machine reprocessing                                     |  | Product no. |
|---|--|-------------|
|  | Irrigation adapter<br>Ø 9 mm, length 64 mm | 163502      |

**ERAGON** modular mini  
Ø 3.5 MM, UNINSULATED

ERAGONMODULAR

4

|   |             | Handle, axial   |   |
|---|-------------|---|---|
| <br>All jaw inserts and sheath tubes can also be combined with ERAGONaxial |             |  |  |
|   |             | with lock, without HF connector   | with lock, without HF connector, not rotatable                                      |
| Rotatable knob  | Product no. | 83930082  | 83930085  |
|    | 8988        | .   |   |







| Jaw insert   |       | Sheath tube, Ø 3.5 mm, insulated |           | Handle, pistol-shaped   | Complete instrument                       |
|--|-------|----------------------------------|-----------|---|---|
| <br>JL   |       | WL 240 mm                        | WL 330 mm | <br>with lock, without HF | • Jaw insert with sheath tube<br>• Handle |
|  |       | Product no.                      | 8390933   |   |   |
| <br>fenestrated, double-action                | 14 mm | 8390208                          | .         | .   | 83902087                                  |
|  |       | 8391208                          | .         | .   | 83912087                                  |
| <br>fenestrated, single-action                | 17 mm | 8390218                          | .         | .   | 83902187                                  |
|  |       | 8391218                          | .         | .   | 83912187                                  |
| <br>double fenestrated, curved, single-action | 17 mm | 8390225                          | .         | .   | 83902257                                  |
|  |       | 8391225                          | .         | .   | 83912257                                  |
| <br>fenestrated, double-action                | 19 mm | 8390226                          | .         | .   | 83902267                                  |
|  |       | 8391226                          | .         | .   | 83912267                                  |

\* JL = jaw length when jaw section closed (approximate measurements)  
 HF connection cable: see sheet BDE116/117

III23 || Subject to modifications. Please note that some products may not be available in all countries. Please always take note of the information that is provided with the product. For more detailed information, please consult with your contact partner or directly with Richard Wolf GmbH.



**ERAGON** modular  
mini  
Ø 3.5 MM, UNINSULATED

| Jaw insert  |     |         | Sheath tube, Ø 3.5 mm, insulated |              | Handle, pistol-shaped   | Complete instrument<br>• Jaw insert with sheath tube<br>• Handle |
|---|-----|---------|----------------------------------|--------------|---|--|
|    |     |         | WL<br>240 mm                     | WL<br>330 mm | <br>with lock,<br>without HF |  |
|   |     |         | Product no.                      | 8390933      |   | 8391933  |
| <br>Grasping forceps<br>Ø 3.5 mm bndl<br>13 mm<br>fenestrated, double-action   | JL* | 8390219 | •                                |              | •   | 83902197   |
|   |     | 8391219 |                                  | •            | •   | 83912197   |
| <br>Grasping forceps<br>Ø 3.5 mm bndl<br>17 mm<br>fenestrated, single-action | JL* | 8390220 | •                                |              | •   | 83902207   |
|   |     | 8391220 |                                  | •            | •   | 83912207   |
| <br>Universal grasping forceps<br>Ø 3.5 mm bndl<br>14 mm<br>double-action    | JL* | 8390209 | •                                |              | •   | 83902097   |
|   |     | 8391209 |                                  | •            | •   | 83912097   |
| <br>Babcock forceps<br>Ø 3.5 mm bndl<br>19 mm<br>double-action               | JL* | 8390210 | •                                |              | •   | 83902107   |
|   |     | 8391210 |                                  | •            | •   | 83912107   |

\* JL = jaw length when jaw section closed (approximate measurements)

HF connection cable: see sheet BDE116/117







| Accessories for manual and machine reprocessing                                     |  | Product no. |
|---|--|-------------|
|  | Irrigation adapter<br>Ø 9 mm, length 64 mm | 163503      |







**ERAGON** modular

Ø 5.0 MM, INSULATED

ERAGONMODULAR

4

|  |             | Handle, axial   |   |  |   |
|--|-------------|---|---|--|---|
| <br>All jaw inserts and sheath tubes can also be combined with <b>ERAGONaxial</b> |             |  |  |  |  |
|  |             | with lock   | without lock, with HF connector   | without lock, with HF connector  | with lock, not rotatable  |
| Rotatable knob   | Product no. | 83930082  | 83930083  | 83930084   | 83930085  |
|   | 8988        | •   | •   | •  |   |

| Jaw insert  |       | Sheath tube, Ø 5.0 mm, insulated   |           | Handle, pistol-shaped  | Complete instrument   |
|---|-------|--|-----------|--|---|
|   |       |  |           |  | <ul style="list-style-type: none"> <li>• Jaw insert with sheath tube</li> <li>• Handle</li> </ul> |
|   | JL*   | SL 330 mm  | SL 450 mm | with lock, with HF, mono   | Product no.   |
|  | 21 mm | 8393.281   | •         | •  | <b>83932817</b>   |
| curved, with fine cross tothing, double-action                                      |       | 8394.281   | •         | •  | <b>83942817</b>   |
|  | 22 mm | 8393.283   | •         | •  | <b>83932837</b>   |
| angled, fine, pyramid-shaped tothing, double-action                                 |       |  |           |  |   |
|  | 21 mm | 8393.185   | •         | •  | <b>83931857</b>   |
| fenestrated, with fine cross tothing, 15 mm long, single-action                     |       |  |           |  |   |
|  | 26 mm | 8393.184   | •         | •  | <b>83931847</b>   |
| fenestrated, with fine cross tothing, 20 mm long, single-action                     |       | 8394.184   | •         | •  | <b>83941847</b>   |







\* JL = jaw length when jaw section closed (approximate measurements)

HF connection cable: see sheet BDE116/117

III23 || Subject to modifications. Please note that some products may not be available in all countries. Please always take note of the information that is provided with the product. For more detailed information, please consult with your contact partner or directly with Richard Wolf GmbH.

**ERAGON** modular

Ø 5.0 MM, INSULATED

| Jaw insert  |       |             | Sheath tube, Ø 5.0 mm, insulated |           |           | Handle, pistol-shaped |                             |                          | Complete instrument<br>• Jaw insert with sheath tube<br>• Handle |
|---|-------|-------------|----------------------------------|-----------|-----------|-----------------------|-----------------------------|--------------------------|--|
|    |       |             | SL 260 mm                        | SL 330 mm | SL 450 mm | with lock, without HF | without lock, with HF, mono | with lock, with HF, mono |  |
|   | JL*   | Product no. | 8392933                          | 8393933   | 8394933   | 83930072              | 83930073                    | 83930074                 | Product no.  |
| <br><b>Dolphin dissector forceps mono Ø 5 mm bndl</b><br>angled, with fine cross-toothing, with channel, narrow, 15 mm long, double-action | 17 mm | 8393.285    |                                  | •         |           |                       | •                           |                          | <b>83932857</b>  |
| <br><b>Dissector forceps mono Ø 5 mm bndl</b><br>fine pyramid-shaped toothing, narrow, 18 mm, double-action                              | 23 mm | 8393.289    |                                  | •         |           |                       |                             | •                        | <b>83932897</b>  |
| <br><b>Atraumatic grasping forceps Ø 5 mm bndl</b><br>Channel with wavy tooth edge, 20 mm, single-action                                 | 26 mm | 8393.292    |                                  | •         |           |                       | •                           |                          | <b>83932925</b>  |
| <br><b>Atraumatic grasping forceps Ø 5 mm bndl</b><br>Channel with wavy tooth edge, 20 mm, double-action                                 | 26 mm | 8393.293    |                                  | •         |           |                       | •                           |                          | <b>83932935</b>  |
|   |       | 8394.293    |                                  |           | •         |                       | •                           |                          | <b>83942935</b>  |
| <br><b>Grasping forceps, mono Ø 5 mm bndl</b><br>fine, pyramid-shaped toothing, narrow double-action                                     | 19 mm | 8393.288    |                                  | •         |           |                       |                             | •                        | <b>83932887</b>  |
| <br><b>Atraumatic grasping forceps mono Ø 5 mm bndl</b><br>fenestrated, with cross toothing, double-action                               | 19 mm | 8392.181    | •                                |           |           |                       |                             | •                        | <b>83921817</b>  |
|   |       | 8393.181    |                                  | •         |           |                       |                             | •                        | <b>83931817</b>  |
|   |       | 8394.181    |                                  |           | •         |                       |                             | •                        | <b>83941817</b>  |







\* JL = jaw length when jaw section closed (approximate measurements)







HF connection cable: see sheet BDE116/117

**ERAGON** modular  
Ø 5.0 MM, INSULATED

ERAGONMODULAR

4

|  |             | Handle, axial   |   |  |   |
|--|-------------|---|---|--|---|
| <br>All jaw inserts and sheath tubes can also be combined with <b>ERAGONaxial</b> |             |  |  |  |  |
|  |             | with lock   | without lock, with HF connector   | without lock, with HF connector  | with lock, not rotatable  |
| Rotatable knob   | Product no. | 83930082  | 83930083  | 83930084   | 83930085  |
|   | 8988        | •   | •   | •  |   |

| Jaw insert  |       | Sheath tube, Ø 5.0 mm, insulated   |           | Handle, pistol-shaped   |                       | Complete instrument<br>• Jaw insert with sheath tube<br>• Handle |                 |
|---|-------|--|-----------|---|-----------------------|--|-----------------|
|   |       |  |           |  |                       |  |                 |
|   | JL*   | Product no.  | SL 330 mm | SL 450 mm   | with lock, without HF | without lock, with HF, mono                                      | Product no.     |
| <br><b>Atraumatic grasping forceps</b><br>mono Ø 5 mm bndl<br>18 mm<br>smooth, double-action                               | 18 mm | 8393.195   | •         |   |                       | •  | <b>83931957</b> |
|   |       | 8394.195   |           | •   |                       |  | •               |
| <br><b>Babcock forceps</b><br>Ø 5 mm bndl<br>24 mm<br>Gripping surface with fine cross tothing, double-action              | 24 mm | 8393.186   | •         |   |                       | •  | <b>83931867</b> |
|   |       |  |           |   |                       |  |                 |
| <br><b>Babcock forceps</b><br>Ø 5 mm bndl<br>26 mm<br>large distal gripping surface with fine cross tothing, double-action | 26 mm | 8393.187   | •         |   |                       | •  | <b>83931877</b> |
|   |       | 8394.187   |           | •   |                       |  | •               |
| <br><b>Debaque forceps</b><br>Ø 5 mm bndl<br>39 mm<br>atraumatic clamp, double-action                                      | 39 mm | 8393190  | •         |   |                       | •  | <b>83931907</b> |









\* JL = jaw length when jaw section closed (approximate measurements)

HF connection cable: see sheet BDE50 1710

III23 || Subject to modifications. Please note that some products may not be available in all countries. Please always take note of the information that is provided with the product. For more detailed information, please consult with your contact partner or directly with Richard Wolf GmbH.

**ERAGON** modular

Ø 5.0 MM, INSULATED

| Jaw insert  |       |             | Sheath tube, Ø 5.0 mm, insulated  |              | Handle, pistol-shaped  |                             | Complete instrument<br>• Jaw insert with sheath tube<br>• Handle |
|---|-------|-------------|---|--------------|--|-----------------------------|--|
|    |       |             |  |              |  |                             |  |
|   |       |             | SL<br>330 mm  | SL<br>450 mm | with lock,<br>without HF   | with lock,<br>with HF, mono |  |
|   | JL*   | Product no. | 8393933   | 8394933      | 83930072   | 83930074                    | Product no.  |
| <br><b>Debaque forceps</b><br>Ø 5 mm bndl<br>atraumatic clamp,<br>double-action  | 48 mm | 8393191     | •   |              | •  |                             | <b>83931917</b>  |
| <br><b>Grasping forceps, mono</b><br>Ø 5 mm bndl<br>with a row of teeth,<br>double-action                                    | 17 mm | 8393.485    | •   |              |  | •                           | <b>83934857</b>  |
| <br><b>Grasping forceps, mono</b><br>Ø 5 mm bndl<br>with one tooth,<br>fine cross toothing, narrow,<br>double-action         | 19 mm | 8393.486    | •   |              |  | •                           | <b>83934867</b>  |
| <br><b>Grasping forceps, mono</b><br>Ø 5 mm bndl<br>with two teeth,<br>fine cross toothing,<br>single-action                 | 17 mm | 8393.487    | •   |              |  | •                           | <b>83934877</b>  |
| <br><b>Grasping forceps</b><br>Ø 5 mm bndl<br>with two teeth<br>wavy gripping surface,<br>double-action                      |       | 8393.490    | •   |              | •  |                             | <b>83934907</b>  |
|   |       | 8394.490    |   | •            | •  |                             | <b>83944907</b>  |
| <br><b>Petelin dissector forceps</b><br>mono Ø 5 mm bndl<br>angled 30° to the left,<br>with cross toothing,<br>single-action | 17 mm | 8393.282    | •   |              |  | •                           | <b>83932827</b>  |







\* JL = jaw length when jaw section closed (approximate measurements)









HF connection cable: see sheet BDE116/117

**ERAGON** modular  
Ø 5.0 MM, INSULATED

ERAGONMODULAR

4

|   |                    | Handle, axial   |   |  |   |
|---|--------------------|---|---|--|---|
| <br>All jaw inserts and sheath tubes can also be combined with ERAGONaxial |                    |  |  |  |  |
|   |                    | with lock   | without lock, with HF connector   | without lock, with HF connector  | with lock, not rotatable  |
| <b>Rotatable knob</b>   | <b>Product no.</b> | 83930082  | 83930083  | 83930084   | 83930085  |
|    | 8988               | •   | •   | •  |   |







| Jaw insert   |       | Sheath tube, Ø 5.0 mm, insulated   | Handle, pistol-shaped   |  |  | Complete instrument                       |                    |
|--|-------|--|---|--|--|---|--------------------|
|    |       | <br>SL<br>330 mm |  |  |  | • Jaw insert with sheath tube<br>• Handle |                    |
|  | JL*   | <b>Product no.</b>   | 8393933   | 83930072   | 83930073   | 83930074                                  | <b>Product no.</b> |
| <br><b>Plate-shaped grasping forceps mono Ø 5 mm bndl</b><br>fenestrated with fine cross tothing, double-action | 18 mm | 8393.182   | •   |  |  | •   | <b>83931827</b>    |
| <br><b>Grasping forceps mono Ø 5 mm bndl</b><br>with cross tothing, double-action                               | 21 mm | 8393.183   | •   |  | •  |   | <b>83931837</b>    |
| <br><b>Grasping forceps mono Ø 5 mm bndl</b><br>distal cross tothing with channel, double-action                | 15 mm | 8393.287   | •   |  | •  |   | <b>83932877</b>    |
| <br><b>Claw grasping forceps Ø 5 mm bndl</b><br>double-action   | 27 mm | 8393.494   | •   | •  |  |   | <b>83934945</b>    |

\* JL = jaw length when jaw section closed (approximate measurements)

HF connection cable: see sheet BDE116/117

III23 || Subject to modifications. Please note that some products may not be available in all countries. Please always take note of the information that is provided with the product. For more detailed information, please consult with your contact partner or directly with Richard Wolf GmbH.

**ERAGON** modular  
Ø 5.0 MM, INSULATED

| Jaw insert   |       |             | Sheath tube, Ø 5.0 mm, insulated |           | Handle, pistol-shaped |                             |                          | Complete instrument<br>• Jaw insert with sheath tube<br>• Handle |
|--|-------|-------------|----------------------------------|-----------|-----------------------|-----------------------------|--------------------------|--|
|   |       |             | SL 330 mm                        | SL 450 mm | with lock, without HF | without lock, with HF, mono | with lock, with HF, mono |  |
|  | JL*   | Product no. | 8393933                          | 8394933   | 83930072              | 83930073                    | 83930074                 | Product no.  |
| <b>Myoma grasping forceps</b><br>Ø 5 mm bndl<br><br>2x3-claw,<br>single-action  | 29 mm | 8393.488    | •                                |           | •                     |                             |                          | <b>83934887</b>  |
| <b>Universal grasping forceps</b><br>mono Ø 5 mm bndl<br><br>with pyramid-shaped<br>toothing and cross<br>toothing, double-action | 18 mm | 8393.481    | •                                |           |                       |                             | •                        | <b>83934817</b>  |
| <b>Universal grasping forceps</b><br>Ø 5 mm bndl<br><br>pyramid-shaped<br>toothing and cross<br>toothing, double-action           | 26 mm | 8393.482    | •                                |           | •                     |                             |                          | <b>83934827</b>  |
| <b>Grasping forceps</b><br>mono Ø 5 mm bndl<br><br>Pike-mouth,<br>double-action   | 20 mm | 8393.483    | •                                |           |                       |                             | •                        | <b>83934837</b>  |
| <b>Biopsy forceps</b><br>mono Ø 5 mm bndl<br><br>with spikes,<br>double-action  | 13 mm | 8393.091    | •                                |           |                       |                             | •                        | <b>83930917</b>  |
|  |       | 8394.091    |                                  | •         |                       | •                           |                          | <b>83940917</b>  |
| <b>Biopsy forceps</b><br>mono Ø 5 mm bndl<br><br>severing,<br>single-action   | 14 mm | 8393.092    | •                                |           |                       |                             | •                        | <b>83930927</b>  |
|  |       | 8394.092    |                                  | •         |                       | •                           |                          | <b>83940927</b>  |

\* JL = jaw length when jaw section closed (approximate measurements)







HF connection cable: see sheet BDE116/117









11123 || Subject to modifications. Please note that some products may not be available in all countries. Please always take note of the information that is provided with the product. For more detailed information, please consult with your contact partner or directly with Richard Wolf GmbH.

**ERAGON** modular  
Ø 5.0 MM, INSULATED

ERAGONMODULAR

4

|   |                    | Handle, axial   |   |  |   |
|---|--------------------|---|---|--|---|
| <br>All jaw inserts and sheath tubes can also be combined with ERAGONaxial |                    |  |  |  |  |
|   |                    | with lock   | without lock, with HF connector   | without lock, with HF connector  | with lock, not rotatable  |
| <b>Rotatable knob</b>   | <b>Product no.</b> | 83930082  | 83930083  | 83930084   | 83930085  |
|    | 8988               | •   | •   | •  |   |







| Jaw insert   |       |                    | Sheath tube, Ø 5.0 mm, insulated   |           | Handle, pistol-shaped   |  | Complete instrument<br>• Jaw insert with sheath tube<br>• Handle |
|--|-------|--------------------|--|-----------|---|--|--|
|    |       |                    |  |           |  |  |  |
|  | JL*   | <b>Product no.</b> | SL 330 mm  | SL 450 mm | with lock, without HF   | without lock, with HF, mono  | <b>Product no.</b>   |
| <br><b>Biopsy forceps mono Ø 5 mm bndl</b><br>pointed spoon forceps, single-action                            | 20 mm | 8393.093           | •  |           |   | •  | <b>83930937</b>  |
| <br><b>Knot pusher Ø 5 mm bndl</b><br>with distal recess, double-action                                       | 17 mm | 8393.345           | •  |           | •   |  | <b>83933457</b>  |
|  |       | 8394.345           |  | •         |   |  | <b>83943457</b>  |
| <br><b>Grasping forceps Ø 5 mm bndl</b><br>spring jaw sections fenestrated with cross toothing, double-action | 37 mm | 8393.188           | •  |           | •   |  | <b>83931887</b>  |
| <br><b>Grasping forceps Ø 5 mm bndl</b><br>spring jaw sections fenestrated with cross toothing, double-action | 47 mm | 8393.189           | •  |           | •   |  | <b>83931897</b>  |
|  |       | 8394.189           |  | •         | •   |  | <b>83941897</b>  |

\* JL = jaw length when jaw section closed (approximate measurements)  
HF connection cable: see sheet BDE116/117

III23 || Subject to modifications. Please note that some products may not be available in all countries. Please always take note of the information that is provided with the product. For more detailed information, please consult with your contact partner or directly with Richard Wolf GmbH.



**ERAGON** modular  
Ø 5.0 MM, INSULATED

| Jaw insert  |       |             | Sheath tube, Ø 5.0 mm, insulated |          | Handle, pistol-shaped |                          | Complete instrument<br>• Jaw insert with sheath tube<br>• Handle |
|---|-------|-------------|----------------------------------|----------|-----------------------|--------------------------|--|
|    |       |             | SL<br>330 mm                     | SL450 mm | with lock, without HF | with lock, with HF, mono |  |
|   | JL*   | Product no. | 8393933                          | 8394933  | 83930072              | 83930074                 | Product no.  |
| <br><b>Debaquey forceps</b><br>Ø 5 mm bndl<br>atraumatic, spring jaw sections with cross toothing, double-action | 47 mm | 8393.291    | •                                |          | •                     |                          | <b>83932917</b>  |
| <br><b>Dissector forceps mono</b><br>Ø 5 mm bndl<br>angled, double-action                                      | 18 mm | 8393192     | •                                |          |                       | •                        | <b>83931927</b>  |
|   |       | 8394192     |                                  | •        |                       | •                        | <b>83941927</b>  |
| <br><b>Grasping forceps, mono</b><br>Ø 5 mm bndl<br>double-action  | 16 mm | 8393193     | •                                |          | •                     |                          | <b>83931937</b>  |
|   |       | 8394193     |                                  | •        | •                     |                          | <b>83941937</b>  |
| <br><b>Dissector forceps mono</b><br>Ø 5 mm bndl<br>double-action  | 24 mm | 8393194     | •                                |          |                       | •                        | <b>83931947</b>  |
|   |       | 8394194     |                                  | •        |                       | •                        | <b>83941947</b>  |
| <br><b>Dissector forceps mono</b><br>Ø 5 mm bndl<br>double-action  | 30 mm | 8393197     | •                                |          |                       | •                        | <b>83931977</b>  |
|   |       | 8394197     |                                  | •        |                       | •                        | <b>83941977</b>  |
| <br><b>Dissector forceps mono</b><br>Ø 5 mm bndl<br>fine tips double-action                                    | 33 mm | 8393198     | •                                |          |                       | •                        | <b>83931987</b>  |
|   |       | 8394198     |                                  | •        |                       | •                        | <b>83941987</b>  |







\* JL = jaw length when jaw section closed (approximate measurements)







HF connection cable: see sheet BDE116/117

**ERAGON** modular  
Ø 5.0 MM, INSULATED

ERAGONMODULAR

4

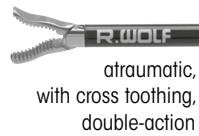







|  |             | Handle, axial   |   |  |   |
|--|-------------|---|---|--|---|
| <br>All jaw inserts and sheath tubes can also be combined with <b>ERAGONaxial</b> |             |  |  |  |  |
|  |             | with lock   | without lock, with HF connector   | without lock, with HF connector  | with lock, not rotatable  |
| Rotatable knob   | Product no. | 83930082  | 83930083  | 83930084   | 83930085  |
|   | 8988        | •   | •   | •  |   |

| Jaw insert   |     | Sheath tube, Ø 5.0 mm, insulated   |           | Handle, pistol-shaped  | Complete instrument   |                 |
|--|-----|--|-----------|--|---|-----------------|
|    |     |  |           |  | <ul style="list-style-type: none"> <li>• Jaw insert with sheath tube</li> <li>• Handle</li> </ul> |                 |
|  |     | SL 330 mm  | SL 450 mm | with lock, with HF, mono   |   |                 |
|  | JL* | Product no.  | 8393933   | 8394933  | 83930074  | Product no.     |
| <br>Dissector forceps mono Ø 5 mm bndl<br>32 mm<br>double-action  |     | 8393199  | •         |  | •   | <b>83931997</b> |
|  |     | 8394199  |           | •  |   | •               |
| <br>Dissector forceps mono Ø 5 mm bndl<br>19 mm<br>fine tip, double-action                                  |     | 8393200  | •         |  | •   | <b>83932007</b> |
|  |     | 8394200  |           | •  |   | •               |
| <br>Atraumatic grasping forceps mono Ø 5 mm bndl<br>16 mm<br>atraumatic, with cross toothing, double-action |     | 8393210  | •         |  | •   | <b>83932107</b> |
|  |     |  |           |  |   |                 |
| <br>Atraumatic grasping forceps mono Ø 5 mm bndl<br>19mm<br>atraumatic, with cross toothing, double-action  |     | 8393220  | •         |  | •   | <b>83932207</b> |
|  |     | 8394220  |           | •  |   | •               |

\* JL = jaw length when jaw section closed (approximate measurements)  
 HF connection cable: see sheet BDE116/117

III23 || Subject to modifications. Please note that some products may not be available in all countries. Please always take note of the information that is provided with the product. For more detailed information, please consult with your contact partner or directly with Richard Wolf GmbH.

**ERAGON** modular  
Ø 5.0 MM, INSULATED

| Jaw insert  |       |              | Sheath tube, Ø 5.0 mm, insulated  |              | Handle, pistol-shaped  |                             | Complete instrument<br>• Jaw insert with sheath tube<br>• Handle |
|---|-------|--------------|---|--------------|--|-----------------------------|--|
|    |       |              |  |              |  |                             |  |
|   |       |              | SL<br>330 mm  | SL<br>450 mm | with lock,<br>without HF   | with lock,<br>with HF, mono |  |
|   | JL*   | Product no.: | 8393933   | 8394933      | 83930072   | 83930074                    | Product no.:   |
| <br><b>Atraumatic grasping forceps<br/>Ø 5 mm bndl</b><br>atraumatic, with pyramid-shaped<br>toothings and cross toothings,<br>double-action | 29 mm | 8393223      | •   |              | •  |                             | <b>83932237</b>  |
|   |       | 8394223      |   | •            | •  |                             | <b>83942237</b>  |
| <br><b>Atraumatic grasping forceps<br/>Ø 5 mm bndl</b><br>atraumatic,<br>single fenestrated with cross<br>toothings, double-action         | 25 mm | 8393250      | •   |              | •  |                             | <b>83932507</b>  |
|   |       | 8394250      |   | •            | •  |                             | <b>83942507</b>  |
| <br><b>Atraumatic grasping forceps<br/>Ø 5 mm bndl</b><br>atraumatic,<br>double fenestrated and curved<br>single-action                    | 32 mm | 8393229      | •   |              | •  |                             | <b>83932297</b>  |
|   |       | 8394229      |   | •            | •  |                             | <b>83942297</b>  |
| <br><b>Grasping forceps<br/>Ø 5 mm bndl</b><br>atraumatic, narrow and<br>rounded, double-action  | 15 mm | 8393230      | •   |              | •  |                             | <b>83932307</b>  |
|   |       | 8394230      |   | •            | •  |                             | <b>83942307</b>  |
| <br><b>Dissector forceps<br/>mono Ø 5 mm bndl</b><br>curved,<br>double-action  | 19 mm | 8393240      | •   |              |  | •                           | <b>83932407</b>  |
|   |       | 8394240      |   | •            |  | •                           | <b>83942407</b>  |
| <br><b>Dissector forceps<br/>mono Ø 5 mm bndl</b><br>single fenestrated<br>double-action   | 17 mm | 8393242      | •   |              | •  |                             | <b>83932427</b>  |
|   |       | 8394242      |   | •            | •  |                             | <b>83942427</b>  |

\* JL = jaw length when jaw section closed (approximate measurements)  
HF connection cable: see sheet BDE116/117







11123 || Subject to modifications. Please note that some products may not be available in all countries. Please always take note of the information that is provided with the product. For more detailed information, please consult with your contact partner or directly with Richard Wolf GmbH.







**ERAGON** modular

Ø 5.0 MM, INSULATED

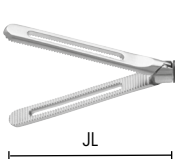
ERAGONMODULAR

4



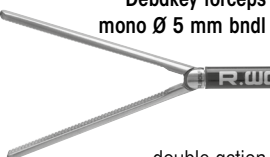





|   |             | Handle, axial   |   |  |   |
|---|-------------|---|---|--|---|
| <br>All jaw inserts and sheath tubes can also be combined with ERAGONaxial |             |  |  |  |  |
|   |             | with lock   | without lock, with HF connector   | without lock, with HF connector  | with lock, not rotatable  |
| Rotatable knob  | Product no. | 83930082  | 83930083  | 83930084   | 83930085  |
|    | 8988        | •   | •   | •  |   |

| Jaw insert  |   | Sheath tube, Ø 5.0 mm, insulated   |           | Handle, pistol-shaped   |  | Complete instrument<br>• Jaw insert with sheath tube<br>• Handle |                 |
|---|---|--|-----------|---|--|--|-----------------|
|   |   |  |           |  |  |  |                 |
|   | JL*   | Product no.  | SL 330 mm | SL 450 mm   | with lock, without HF  | with lock, with HF, mono   | Product no.     |
| <br>Intestine grasping forceps<br>Ø 5 mm bndl<br>atraumatic,<br>single fenestrated with cross<br>toothing, double-action | 38 mm   | 8393249  | •         |   | •  |  | <b>83932497</b> |
|   |   | 8394249  |           | •   | •  |  | <b>83942497</b> |
| <br>Debaque forceps<br>mono Ø 5 mm bndl<br>curved,<br>double-action  | 35 mm   | 8393256  | •         |   |  | •  | <b>83932567</b> |
|   | <br>Debaque forceps<br>mono Ø 5 mm bndl<br>double-action | 47 mm  | 8393258   | •   |  |  | •               |
|   |   | 8394258  |           | •   | •  | •  | <b>83942587</b> |

\* JL = jaw length when jaw section closed (approximate measurements)  
 HF connection cable: see sheet BDE116/117

**ERAGON** modular

Ø 5.0 MM, INSULATED

| Jaw insert   |       |             | Sheath tube, Ø 5.0 mm, insulated  |              | Handle, pistol-shaped   | Complete instrument<br>• Jaw insert with sheath tube<br>• Handle |
|--|-------|-------------|---|--------------|---|--|
|   |       |             |  |              |  |  |
|  |       |             | SL<br>330 mm  | SL<br>450 mm | without lock,<br>with HF, mono  |  |
|  | JL*   | Product no. | 8393933   | 8394933      | 83930073  | Product no.  |
| <br>Metzenbaum scissors<br>mono Ø 5 mm bndl         | 23 mm | 8393.041    | •   |              | •   | 83930417   |
|  |       | 8394.041    |   | •            | •   | 83940417   |
| <br>Metzenbaum micro scissors<br>mono Ø 5 mm bndl | 18 mm | 8393.044    | •   |              | •   | 83930447   |
| <br>Scissors<br>mono Ø 5 mm bndl                  | 20 mm | 8393.045    | •   |              | •   | 83930457   |
| <br>Hook scissors<br>mono Ø 5 mm bndl             | 14 mm | 8393.081    | •   |              | •   | 83930817   |
|  |       | 8394.081    |   | •            | •   | 83940817   |
| <br>Metzenbaum micro scissors<br>mono Ø 5 mm bndl | 21 mm | 8393243     | •   |              | •   | 83932437   |
|  |       | 8394243     |   | •            | •   | 83942437   |
| <br>Scissors<br>mono Ø 5 mm bndl                  | 26 mm | 8393246     | •   |              | •   | 83932467   |
|  |       | 8394246     |   | •            | •   | 83942467   |







\* JL = jaw length when jaw section closed (approximate measurements)







HF connection cable: see sheet BDE116/117

**ERAGON<sup>modular</sup>**  
 Ø 5.0 MM, INSULATED

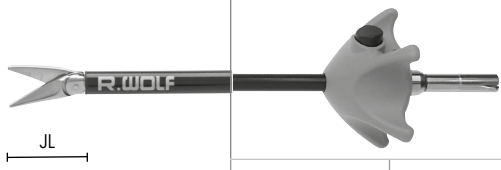
ERAGONMODULAR

4

|   |             | Handle, axial   |   |  |   |
|---|-------------|---|---|--|---|
| <br>All jaw inserts and sheath tubes can also be combined with ERAGONaxial |             |  |  |  |  |
|   |             | with lock   | without lock, with HF connector   | without lock, with HF connector  | with lock, not rotatable  |
| Rotatable knob  | Product no. | 83930082  | 83930083  | 83930084   | 83930085  |
|    | 8988        | •   | •   | •  |   |

| Jaw insert  |       | Sheath tube, Ø 5.0 mm, insulated |           | Handle, pistol-shaped   |  | Complete instrument<br>• Jaw insert with sheath tube<br>• Handle |                 |
|---|-------|----------------------------------|-----------|---|--|--|-----------------|
|   |       | SL 330 mm                        | SL 450 mm |  |  |  |                 |
|   | JL*   | Product no.                      | 8393933   | 8394933   | 83930072   | 83930073   | Product no.     |
|  | 22 mm | 8393248                          | •         |   |  | •  | <b>83932487</b> |
| fine-toothed, fine tip double-action  |       | 8394248                          |           | •   |  | •  | <b>83942487</b> |
|  | 17 mm | 8393.345                         | •         |   |  | •  | <b>83933457</b> |
| with distal recess, double-action   |       | 8394345                          |           | •   |  | •  | <b>83943457</b> |
|  | 47 mm | 8393253                          | •         |   |  | •  | <b>83932537</b> |
| 90° articulating with distal slot   |       | 8394253                          |           | •   |  | •  | <b>83942537</b> |



\* JL = jaw length when jaw section closed (approximate measurements)

HF connection cable: see sheet BDE116/117

| Accessories for manual and machine reprocessing                                     |   | Product no.   |
|---|---|---------------|
|  | <b>Irrigation adapter</b><br>Ø 9 mm, length 64 mm | <b>163502</b> |

III23 | Subject to modifications. Please note that some products may not be available in all countries. Please always take note of the information that is provided with the product. For more detailed information, please consult with your contact partner or directly with Richard Wolf GmbH.

**ERAGON<sup>modu</sup> blades**  
 Ø 5.0 MM, INSULATED

|   |             |   |  |
|---|-------------|---|--|
| <br>All jaw inserts and sheath tubes can also be combined with ERAGONaxial |             | Handle, axial<br> |  |
|   |             | without lock, with HF connector   |  |
| Rotatable knob  | Product no. | 83930083  |  |
|    | 8988        | •   |  |

| Scissors attachment  | Tension rod Ø 5.0 mm |               |               | Sheath tube insulated Ø 5.0 mm |           |           | Handle pistol-shaped  | Complete instrument<br>• Jaw insert with sheath tube<br>• Handle |
|--|----------------------|---------------|---------------|--------------------------------|-----------|-----------|---|--|
|   | for SL 260 mm        | for SL 330 mm | for SL 450 mm | SL 240 mm                      | SL 310 mm | SL 430 mm | <br>without lock, rotatable with HF connector |  |
| Product no.  | 8392934              | 8393934       | 8394934       | 8392935                        | 8393935   | 8394935   | 83930073  | Product no.  |
| <b>Metzenbaum scissors attachment mono</b><br><br>(PACK= 10 PCS), sterile, disposable | •                    | •             | •             | •                              | •         | •         | •   | <b>83920407</b><br><br><b>83930407</b><br><br><b>83940407</b>    |











HF connection cable: see sheet BDE116/117

11123 || Subject to modifications. Please note that some products may not be available in all countries. Please always take note of the information that is provided with the product. For more detailed information, please consult with your contact partner or directly with Richard Wolf GmbH.

**ERAGON** modular

Ø 10 MM, UNINSULATED

|   |                    | Handle, axial   |   |
|---|--------------------|---|---|
| <b>ERAGON</b> axial   |                    |  |  |
| All jaw inserts and sheath tubes can also be combined with <b>ERAGON</b> axial    |                    | with lock, without HF connector   | with lock, without HF connector, not rotatable                                      |
| <b>Rotatable knob</b>   | <b>Product no.</b> | 83930082  | 83930085  |
|  | 8988               | .   | .   |

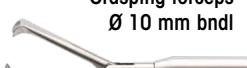





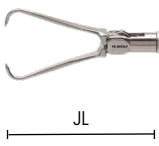

| Jaw insert  |            | Sheath tube, Ø 10.0 mm, insulated  |           | Handle, pistol-shaped  | Complete instrument   |
|---|------------|--|-----------|--|---|
|   |            |  |           |  | <ul style="list-style-type: none"> <li>• Jaw insert with sheath tube</li> <li>• Handle</li> </ul> |
|   |            | SL 327 mm  | SL 447 mm | with lock, without HF  |   |
|   | <b>JL*</b> | <b>Product no.</b>   | 8395902   | 8396902  | <b>Product no.</b>  |
|  | 36 mm      | 8395.225   | .         | .  | <b>83952257</b>   |
| double-action   |            | 8396225  | .         | .  | <b>83962257</b>   |
|  | 35 mm      | 8395.226   | .         | .  | <b>83952268</b>   |
| angled, double-action   |            | 8396226  | .         | .  | <b>83962267</b>   |
|  | 20 mm      | 8395.236   | .         | .  | <b>83952368</b>   |
| Pike-mouth double-action  |            | 8396236  | .         | .  | <b>83962367</b>   |
|  | 49 mm      | 8395.204   | .         | .  | <b>83952048</b>   |
| 2/3 jaws single-action  |            | 8396204  | .         | .  | <b>83962047</b>   |

\* JL = jaw length when jaw section closed (approximate measurements)

HF connection cable: see sheet BDE116/117







**ERAGON** modular  
Ø 10 MM, UNINSULATED



| Jaw insert   |       |             | Sheath tube, Ø 10.0 mm, insulated |              |              | Handle, pistol-shaped |          | Complete instrument<br>• Jaw insert with sheath tube<br>• Handle |
|--|-------|-------------|-----------------------------------|--------------|--------------|-----------------------|----------|--|
|   |       |             | SL<br>327 mm                      | SL<br>447 mm | SL<br>387 mm | with lock, without HF |          |  |
|  | JL*   | Product no. | 8395902                           | 8396902      | 8397902      | 83930072              | 83930082 | Product no.  |
| <br>Claw grasping forceps<br>Ø 10 mm bndl<br>double-action  | 38 mm | 8395.489    | •                                 |              |              | •                     |          | 83954897   |
| <br>Claw grasping forceps<br>Ø 10 mm bndl<br>with additional row of teeth,<br>double-action                      | 38 mm | 8395490     | •                                 |              |              | •                     |          | 83954907   |
| <br>Babcock forceps<br>Ø 10 mm bndl<br>large distal gripping surface with<br>fine cross toothing, double-action | 42 mm | 8395.187    | •                                 |              |              | •                     |          | 83951877   |
|  |       | 8396187     |                                   | •            |              | •                     |          | 83961877   |
| <br>Babcock forceps<br>Ø 10 mm bndl<br>double-action  | 38 mm | 8395.214    | •                                 |              |              | •                     |          | 83952148   |
| <br>Plate-shaped grasping forceps<br>Ø 10 mm bndl<br>double-action  | 50 mm | 8395.234    | •                                 |              |              | •                     |          | 83952347   |
|  |       | 8396234     |                                   | •            |              | •                     |          | 83962347   |
| <br>Spoon forceps<br>Ø 10 mm bndl<br>single-action  | 31 mm | 8395.244    | •                                 |              |              | •                     |          | 83952448   |
| <br>Stapler head grasping forceps<br>Ø 10 mm bndl<br>angled 30°, double-action                                  |       | 8397.655    |                                   |              | •            |                       | •        | 83976558   |





\* JL = jaw length when jaw section closed (approximate measurements)/HF connection cable: see sheet BDE116/117

11123 || Subject to modifications. Please note that some products may not be available in all countries. Please always take note of the information that is provided with the product. For more detailed information, please consult with your contact partner or directly with Richard Wolf GmbH.

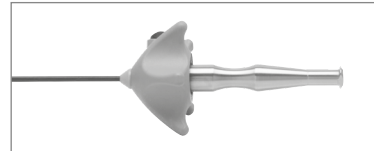
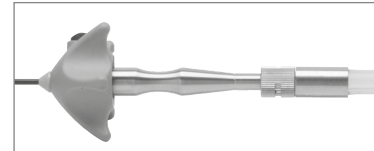
**ERAGON** modular  
ACCESSORIES

| For insulated sheath tubes  |   | Product no.   |
|---|---|---|
|  | For manual and machine reprocessing:<br><br><b>Irrigation adapter</b><br>Ø 9 mm, length 64 mm<br>for insulated sheath tubes | <b>163502</b>   |
|  |    |  |





| For uninsulated sheath tubes  |  | Product no.   |
|---|--|---|
|  | For manual and machine reprocessing:<br><br><b>Irrigation adapter cleaning</b><br>Ø 9 mm, length 64 mm<br>for uninsulated sheath tubes | <b>163503</b>   |
|  |   |  |





|  |                |   |
|--|----------------|---|
|  | <b>8393932</b> |  |
|  | <b>8394932</b> |  |



|   |   | Ø    | SL     | Product no.    |
|---|---|------|--------|----------------|
| ERAGONmodular   | <b>Sheath tube insulated Ø 5 mm SL 330 mm</b><br>with distal cm scale | 5 mm | 330 mm | <b>8393932</b> |
|  | <b>Sheath tube insulated Ø 5 mm SL 450 mm</b><br>with distal cm scale | 5 mm | 450 mm | <b>8394932</b> |

III23 || Subject to modifications. Please note that some products may not be available in all countries. Please always take note of the information that is provided with the product. For more detailed information, please consult with your contact partner or directly with Richard Wolf GmbH.

## HANDLE VARIANTS FOR MODULAR SYSTEMS

| Handle, pistol-shaped<br> | rotatable | with lock | without lock | with HF | without HF | Product no. |
|--|-----------|-----------|--------------|---------|------------|-------------|
|                           | •         | •         |              |         | •          | 83930072    |
|                           | •         |           | •            | •       |            | 83930073    |
|                          | •         | •         |              | •       |            | 83930074    |

| Handle, axial<br> | rotatable | with lock | without lock | with HF | without HF | Product no. |
|--|-----------|-----------|--------------|---------|------------|-------------|
|                   | •         | •         |              |         | •          | 83930082    |
|                   | •         |           | •            | •       |            | 83930083    |
|                   | •         | •         |              | •       |            | 83930084    |
|                   |           | •         |              |         | •          | 83930085    |

| Optional for 83930082/83930083/83930084:  |                                | Product no. |
|---|--------------------------------|-------------|
|   | Rotatable knob<br>autoclavable | 8988        |

All ERAGON<sup>modular</sup> components are compatible with ERAGON<sup>axial</sup>

# CHOLANGIOGRAPHY CATHETERGRASPING FORCEPS 5 MM

FORCEPS

5

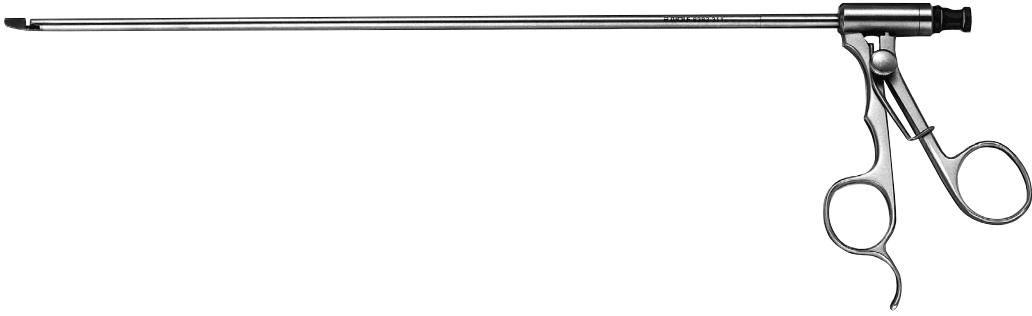







|  |                                   | Outer Ø | WL     | Product no.     |
|--|-----------------------------------|---------|--------|-----------------|
|  | Grasping forceps Ø 5 mm WL 295 mm | 5.0 mm  | 295 mm | <b>8383.311</b> |

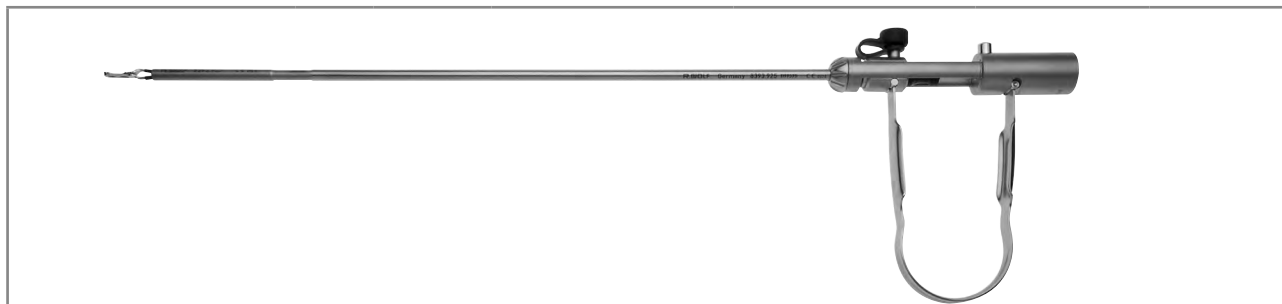

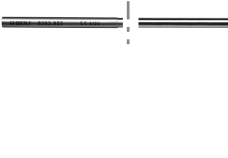

- For inserting a cholangiography catheter up to 7 Fr into the cystic duct

# BIPOLAR FORCEPS 3.5 MM/5.0 MM

WITH SPRING HANDLE  
MODULAR SYSTEM





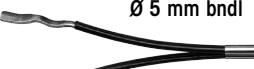



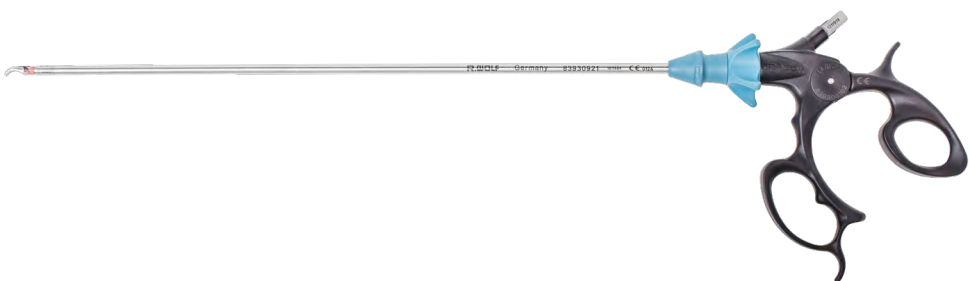

| Grasping forceps jaw insert   |       |             | Outer tube Ø 3.5 mm<br>SL 348 mm   | Screw cap with sleeve<br>Ø 5.0 mm SL 107 mm   | Spring handle<br>bipo  | complete<br>instrument<br>• Jaw insert<br>• Sliding<br>sleeve<br>• Outer tube<br>• Spring handle |
|---|-------|-------------|--|---|--|--|
|   |       |             |  |  |  |  |
|   | JL*   | Product no. | 8391.921   | 8393.978  | 8393.975   | Product no.  |
|  | 39 mm | 8391.715    | •  | •   | •  | <b>8391.742</b>  |

| Kleppinger grasping forceps jaw insert  |       |             | Sliding sleeve<br>SL 319 mm   | Outer tube<br>Ø 5 mm SL 237 mm   | Spring handle<br>bipo   | complete<br>instrument<br>• Jaw insert<br>• Sliding<br>sleeve<br>• Outer tube<br>• Spring handle |
|---|-------|-------------|---|--|---|--|
|  |       |             |  |  |  |  |
|   | JL*   | Product no. | 8393.923  | 8393.925   | 8393.975  | Product no.  |
|  | 53 mm | 8393.714    | •   | •  | •   | <b>8393.741</b>  |

| Accessories                | Product no. |
|----------------------------|-------------|
| RIWO rubber cap, jet black | 15220.019   |
| Luer sealing cap           | 15023.153   |

\* JL = jaw length when jaw section closed (approximate measurements)  
Bipolar connection cable: see sheet BDE118/119





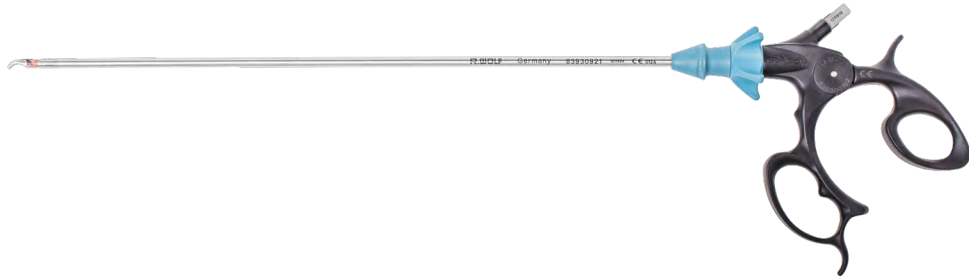

**ERAGON** bipolar  
**MODULAR BIPOLAR INSTRUMENTS, 5.5 MM**  
**ROTATABLE**

|  |       |                    |   |              |   |                    |
|--|-------|--------------------|---|--------------|---|--------------------|
|    |       |                    |   |              |   |                    |
| <b>Jaw insert</b>  |       |                    | <b>Sheath tube Ø 5.5 mm</b>   |              | <b>Handle, pistol-shaped, bipo</b>  |                    |
|   |       |                    |  |              |  |                    |
|  |       |                    | SL<br>320 mm  | SL<br>435 mm | rotatable   |                    |
|  |       |                    |   |              | <b>Complete instrument</b><br>• Jaw insert<br>• Sheath tube<br>• Handle             |                    |
|  | JL*   | <b>Product no.</b> | 83930921  | 82340024     | 839300102   | <b>Product no.</b> |
| <br>Grasping forceps bipo<br>Ø 5.5 mm bndl    | 21 mm | 83930031           | •   |              | •   | <b>839300312</b>   |
|  |       | 839400310          |   |              | •   | <b>839400312</b>   |
| <br>Maryland dissector bipo<br>Ø 5.5 mm bndl  | 23 mm | 83930032           | •   |              | •   | <b>839300322</b>   |
|  |       | 839400320          |   |              | •   | <b>839400322</b>   |
| <br>Dolphin dissector bipo<br>Ø 5.5 mm bndl   | 21 mm | 83930033           | •   |              | •   | <b>839300332</b>   |
|  |       | 839400330          |   |              | •   | <b>839400332</b>   |
| <br>Grasping forceps bipo<br>Ø 5.5 mm bndl    | 23 mm | 83930034           | •   |              | •   | <b>839300342</b>   |
|  |       | 839400340          |   |              | •   | <b>839400342</b>   |
| <br>Preparation forceps bipo<br>Ø 5.5 mm bndl | 19 mm | 83930035           | •   |              | •   | <b>839300352</b>   |
|  |       | 839400350          |   |              | •   | <b>839400352</b>   |

\* JL = jaw length when jaw section closed (approximate measurements)  
 Bipolar connection cable: see sheet BDE118/119

**ERAGON** bipolar  
MODULAR BIPOLAR INSTRUMENTS, 5.5 MM,  
ROTATABLE



| Jaw insert  |       |             | Sheath tube Ø 5.5 mm  |              | Handle, pistol-shaped, bipo   | Complete instrument<br>• Jaw insert<br>• Sheath tube<br>• Handle |
|---|-------|-------------|---|--------------|---|--|
|    |       |             |  |              |  |  |
|   |       |             | SL<br>320 mm  | SL<br>435 mm | rotatable   |  |
|   | JL*   | Product no. | 83930921  | 82340024     | 839300102   | Product no.  |
|  | 19 mm | 83930036    | •   |              | •   | 839300362  |
|  | 22 mm | 83930037    | •   |              | •   | 839300372  |
|   |       | 83930038    | •   |              | •   | 839300382  |
|  | 15 mm | 839400380   |   | •            | •   | 839400382  |
|  | 22 mm | 83930041    | •   |              | •   | 839300412  |
|   |       | 839400410   |   | •            | •   | 839400412  |



\* JL = jaw length when jaw section closed (approximate measurements)  
Bipolar connection cable: see sheet BDE118/119

11123 || Subject to modifications. Please note that some products may not be available in all countries. Please always take note of the information that is provided with the product. For more detailed information, please consult with your contact partner or directly with Richard Wolf GmbH.





# ELECTRODES 2.0 MM/3.5 MM

## MONOPOLAR



|   |  | Outer Ø | WL     | Product no.   |
|---|--|---------|--------|---------------|
|  | Coagulation electrode mono 5 FR<br>WL 400 mm | 1.67 mm | 400 mm | <b>823.05</b> |
|  | Coagulation electrode mono 6 FR<br>WL 400 mm | 2.0 mm  | 400 mm | <b>823.06</b> |



|   |  | Outer Ø | WL     | Product no.     |
|---|--|---------|--------|-----------------|
|  | Hook electrode mono Ø 3.5 mm<br>WL 310 mm                                      | 3.5 mm  | 310 mm | <b>8379.452</b> |
|  | Hook electrode mono Ø 3.5 mm<br>WL 240 mm<br>with distally extended insulation | 3.5 mm  | 240 mm | <b>8785.642</b> |
|  | Needle electrode mono Ø 3.5 mm<br>WL 310 mm                                    | 3.5 mm  | 310 mm | <b>8379.482</b> |
|  | Coagulation electrode mono Ø 3.5 mm<br>WL 310 mm                               | 3.5 mm  | 310 mm | <b>8379.462</b> |

HF connection cable: see sheet BDE116/117







# ELECTRODES 5.0 MM

## MONOPOLAR



|   |  | Outer Ø | WL     | Product no.    |
|---|--|---------|--------|----------------|
|  | Coagulation electrode mono Ø 5 mm<br>WL 330 mm | 5.0 mm  | 330 mm | <b>8383.40</b> |
|   | Coagulation electrode mono Ø 5 mm<br>WL 450 mm | 5.0 mm  | 450 mm | <b>8384.40</b> |



|   |  | Outer Ø | WL     | Product no.     |
|---|--|---------|--------|-----------------|
|  | Hook electrode mono Ø 5 mm<br>WL 340 mm    | 5.0 mm  | 340 mm | <b>8383.423</b> |
|   | Hook electrode mono Ø 5 mm<br>WL 420 mm    |         | 420 mm | <b>8384.423</b> |
|  | Needle electrode mono Ø 5 mm<br>WL 340 mm  | 5.0 mm  | 340 mm | <b>8383.426</b> |
|  | Spatula electrode mono Ø 5 mm<br>WL 340 mm | 5.0 mm  | 340 mm | <b>8383.428</b> |
|  | Myoma dissector mono Ø 5 mm<br>WL 340 mm   | 5.0 mm  | 340 mm | <b>8383429</b>  |

# MULTIFUNCTIONAL SUCTION IRRIGATION SYSTEM

## COMBINATION OPTIONS

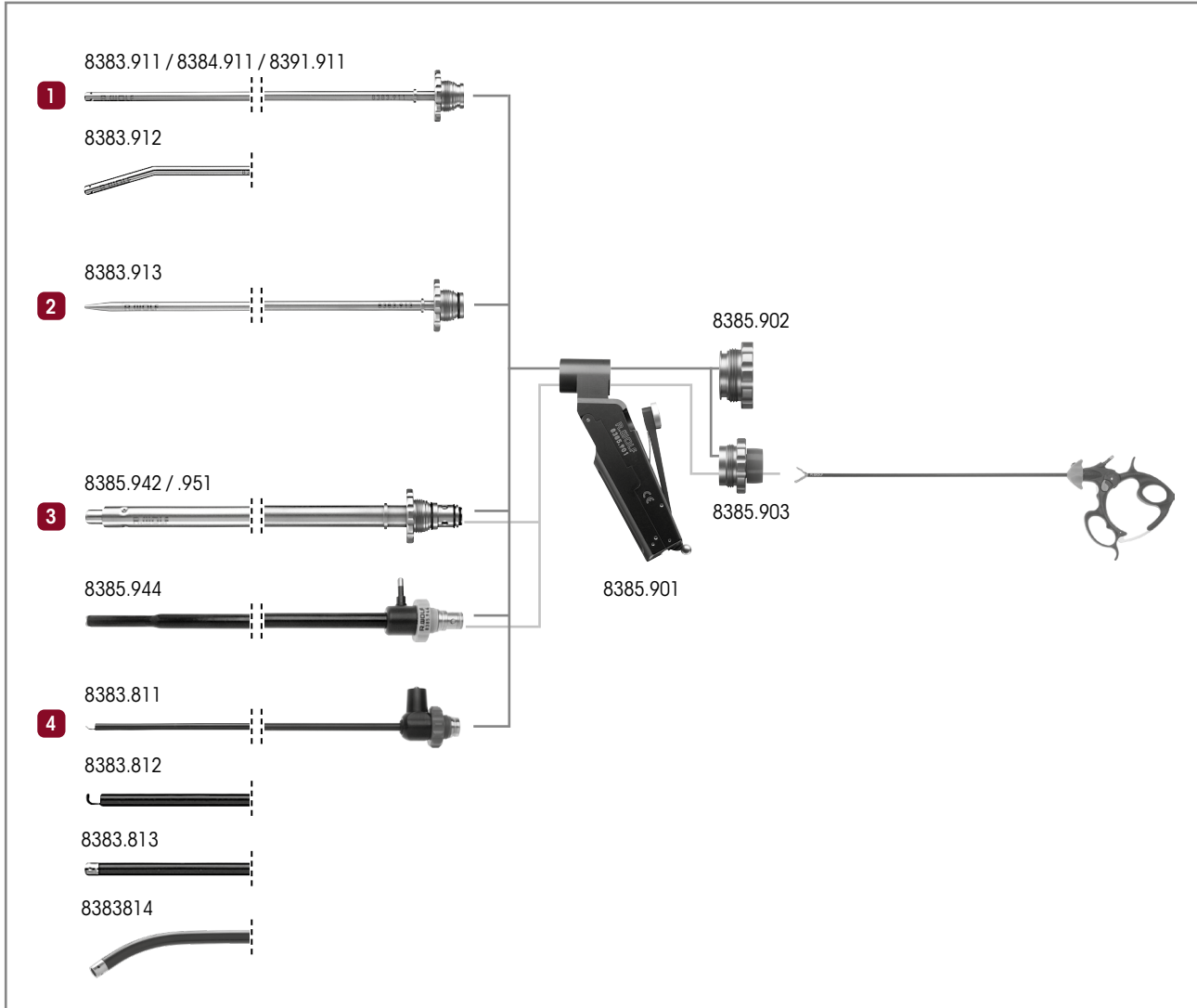

- |  |  |
|--|--|
| <p><b>1 Suction or irrigation:</b><br/>                 Suction irrigation tube Ø 5 mm WL 310 mm ..... 8383.911<br/>                 Suction irrigation tube Ø 5 mm WL 450 mm ..... 8384.911<br/>                 Suction irrigation tube Ø 3.5 mm WL 300 mm ..... 8391.911<br/>                 Suction irrigation tube curved Ø 5 mm WL 310 mm... 8383.912<br/>                 for this: <b>Sealing cap</b> ..... 8385.902</p> <p><b>2 Blunt aquadissection:</b><br/>                 Pressure irrigation tube Ø 5 mm WL 310 mm ..... 8383.913<br/>                 for this: <b>Sealing cap</b> ..... 8385.902</p> <p><b>3 Suction, irrigation, and use<br/>                 of auxiliary instruments Ø 5 mm:</b><br/>                 Suction irrigation tube Ø 10 mm WL 225 mm ..... 8385.942<br/>                 Suction irrigation tube Ø 10 mm WL 330 mm ..... 8385.951<br/>                 Suction irrigation tube Ø mono 10 mm WL 330 mm,<br/>                 insulated, with atraumatic preparation tip ..... 8385.944<br/>                 for this: <b>Sealing adapter</b> ..... 8385.903</p> | <p><b>4 Preparation of tissue with HF:</b><br/>                 HF suction irrigation tube Ø 5.2 mm WL 317 mm<br/>                 insulated with integrated HF spatula probe ..... 8383.811<br/>                 HF suction irrigation tube Ø 5.2 mm WL 317 mm<br/>                 insulated with integrated HF hook electrode ..... 8383.812<br/>                 HF suction irrigation tube Ø 5.2 mm WL 317 mm<br/>                 insulated with integrated HF button electrode ..... 8383.813<br/>                 HF suction irrigation tube Ø 5.4 mm WL 380 mm<br/>                 curved with distal openings,<br/>                 insulated with integrated HF button electrode ..... 8383.814<br/>                 for this: <b>Sealing cap</b> ..... 8385.902</p> |
|--|--|

# MULTIFUNCTIONAL SUCTION IRRIGATION SYSTEM

## SUCTION IRRIGATION HANDLE

|   |                 |
|---|-----------------|
|  <p>8385.901</p> <p><b>AUTOGLAVE</b><br/><b>134° C / 273° F</b></p> |                 |
| <b>Product no.</b>  |                 |
| <p><b>Suction irrigation handle</b></p>   | <b>8385.901</b> |
| <p><b>Sealing cap</b></p>   | <b>8385.902</b> |
| <p>Required to use auxiliary instruments Ø 5 mm:<br/><b>Sealing attachment</b> with opening and membrane valve</p>                                    | <b>8385.903</b> |
| <p>Spare<br/><b>Sealing membrane Ø 17 mm</b><br/>yellow, Ø 17 mm, PACK= 10 PCS, for instruments from 3 to 6 mm</p>                                    | <b>89.103</b>   |

# MULTIFUNCTIONAL SUCTION IRRIGATION SYSTEM

## SUCTION IRRIGATION TUBE SETS – ILLUSTRATION

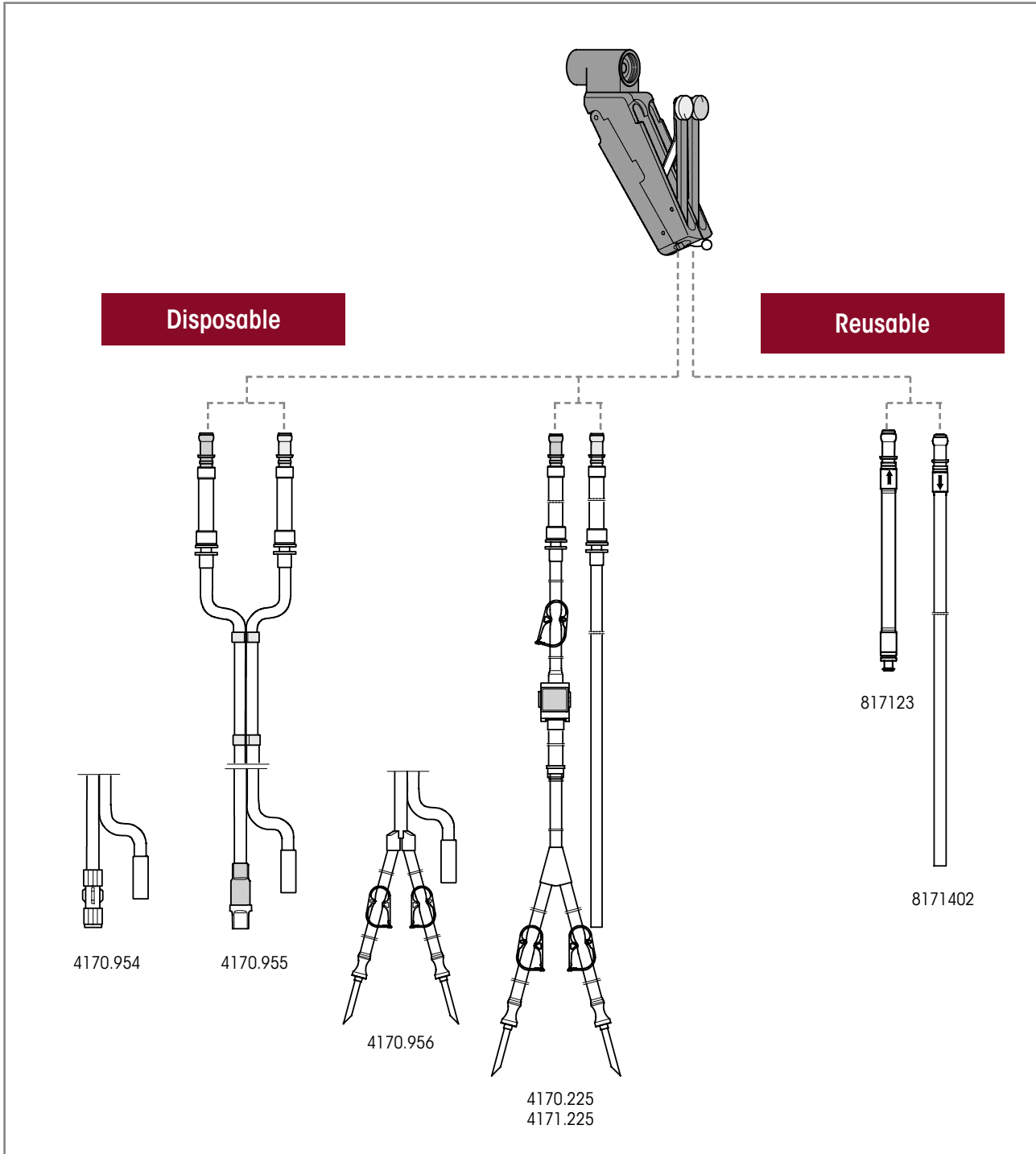

**Suction irrigation tube sets** are used in conjunction with the suction irrigation handle 8385.901 and pump-side tube systems as well as corresponding collection and secretion containers and/or vacuum pumps (e.g., FLUID CONTROL LAP 2216, LAPARO PUMP 2215)

# MULTIFUNCTIONAL SUCTION IRRIGATION SYSTEM







## SUCTION IRRIGATION TUBE SETS FOR SUCTION IRRIGATION HANDLE 8385.901

| Disposable   |  | Product no.     |
|--|--|-----------------|
| <b>Suction irrigation tube set, L 3 m</b><br>(PACK= 10 PCS), sterile                     | <b>Irrigation tube:</b><br>With Luer-Lock, for connection to the irrigation tube of a suction irrigation tube set, e.g., irrigation tube of the Endo-Irrigator 2211<br><b>Suction tube:</b><br>For connection to a collection or secretion container and/or vacuum pump                            | <b>4170.954</b> |
| <b>Suction irrigation tube set with care-lock, L 3 m</b><br>(PACK= 10 PCS), sterile      | <b>Irrigation tube:</b><br>With CARE-LOCK, for connection to an irrigation container<br><b>Suction tube:</b><br>For connection to a collection or secretion container and/or vacuum pump   | <b>4170.955</b> |
| <b>Suction irrigation tube set with piercing spike, L 3 m</b><br>(PACK= 10 PCS), sterile | <b>Irrigation tube:</b><br>With 2 piercing spikes, for connection to an irrigation container<br><b>Suction tube:</b><br>For connection to a collection or secretion container and/or vacuum pump   | <b>4170.956</b> |
| <b>Suction irrigation tube set with piercing spike, L 3 m</b><br>(PACK= 10 PCS), sterile | <b>Irrigation tube:</b><br>With 2 piercing spikes, for connection to an irrigation container, plus Laparo Pump 2215 and Fluid Control Lap 2216<br><b>Suction tube:</b><br>For connection to a collection or secretion container and/or vacuum pump<br><br>Also observe instruction manual GA-A 167 | <b>4170.225</b> |
| <b>Suction irrigation tube set, L 3 m</b><br>(PACK= 10 PCS), sterile                     | <b>Irrigation tube:</b><br>With 2 piercing spikes, for connection to an irrigation container, and Fluid Control Lap 2216<br><b>Suction tube:</b><br>For connection to a collection or secretion container and/or vacuum pump<br><br>Also observe instruction manual GA-A 276                       | <b>4171.225</b> |
| <b>Secretion container, 2.5 l</b>  | 2.5 liters   | <b>41706566</b> |
| <b>Tube set for suction (2 connections)</b>  | sterile disposable product (PACK= 10 PCS), for connecting instruments to collecting container  | <b>T0503-01</b> |

| Reusable                        |   | Product no.      |
|---------------------------------|---|------------------|
| <b>Irrigation tube L 1.2 m</b>  | <b>Irrigation tube:</b><br>With Luer-Lockconnection for connection to the irrigation tube of a suction irrigation tube set, e.g., 8171223 or 8170.223 | <b>817123</b>    |
| <b>Suction tube L 3 m</b>       | silicone, for suction irrigation handle 8385.901  | <b>8171402</b>   |
| <b>Secretion container, 2 l</b> | 2 liters, with lid  | <b>8170.655</b>  |
| <b>Secretion container, 2 l</b> | 2 liters, no lid  | <b>8170.6551</b> |

# MULTIFUNCTIONAL SUCTION IRRIGATION SYSTEM





## SUCTION IRRIGATION TUBES

|  |  | Outer Ø | WL     | Product no.     |
|--|--|---------|--------|-----------------|
|    |  |         |        |                 |
|   | Suction irrigation tube Ø 3.5 mm WL 300 mm   | 3.5 mm  | 300 mm | <b>8391.911</b> |
|   | Suction irrigation tube Ø 5 mm WL 310 mm   | 5.0 mm  | 310 mm | <b>8383.911</b> |
|  | Suction irrigation tube Ø 5 mm WL 450 mm   | 5.0 mm  | 450 mm | <b>8384.911</b> |
|  | Suction irrigation tube curved Ø 5 mm WL 310 mm  | 5.0 mm  | 310 mm | <b>8383.912</b> |
|   | Pressure irrigation tube Ø 5 mm WL 310 mm  | 5.0 mm  | 310 mm | <b>8383.913</b> |
| for use of 5 mm auxiliary instruments  |  |         |        |                 |
| <br>capacity 5.0 mm                               | Suction irrigation tube Ø 10 mm WL 225 mm  | 10.0 mm | 225 mm | <b>8385.942</b> |
|  | Suction irrigation tube Ø 10 mm WL 330 mm  | 10.0 mm | 330 mm | <b>8385.951</b> |
| <br>insulated,<br>with atraumatic preparation tip | Suction irrigation tube mono Ø 10 mm WL 330 mm   | 10.0 mm | 330 mm | <b>8385.944</b> |
|   | required for 8385.951:<br><br><b>Sealing attachment</b><br>with opening and membrane valve<br>Sealing membrane Ø 17 mm |         |        | <b>8385.903</b> |

# MULTIFUNCTIONAL SUCTION IRRIGATION SYSTEM

## SUCTION IRRIGATION TUBES









|   |   | Outer Ø | WL     | Product no.     |
|---|---|---------|--------|-----------------|
| <br>insulated<br>with integrated HF spatula probe      | <b>HF suction irrigation tube Ø 5.2 mm WL 317 mm</b>  | 5.2 mm  | 317 mm | <b>8383.811</b> |
| <br>insulated<br>with integrated HF hook probe       | <b>HF suction irrigation tube Ø 5.2 mm WL 317 mm</b>  | 5.2 mm  | 317 mm | <b>8383.812</b> |
| <br>insulated<br>with integrated HF button electrode | <b>Suction irrigation tube Ø 5 mm WL 450 mm</b>   | 5 mm    | 317 mm | <b>8383.813</b> |
| as alternative to suction irrigation handle:  |   |         |        |                 |
|    | <b>Suction irrigation adapter</b><br>with maintenance-free two-way stopcock,<br>for multifunctional suction irrigation system |         |        | <b>8583819</b>  |

| Accessories         | Product no.         |
|---------------------|---------------------|
| HF connection cable | See page BDE116/117 |

# MULTIFUNCTIONAL SUCTION IRRIGATION SYSTEM

## SUCTION IRRIGATION TUBES





|  |  | Outer Ø | WL     | Product no.     |
|--|--|---------|--------|-----------------|
|   | Suction tube OD 2.8 mm WL 450 mm   | 2.8 mm  | 450 mm | <b>8380.68</b>  |
|   | Suction irrigation tube Ø 5 mm WL 310 mm   | 5.0 mm  | 310 mm | <b>8383.911</b> |
|  | Suction irrigation tube Ø 5 mm WL 450 mm   | 5.0 mm  | 450 mm | <b>8384.911</b> |
|  | Suction irrigation tube curved Ø 5 mm WL 310 mm  | 5.0 mm  | 310 mm | <b>8383.912</b> |
|   | Pressure irrigation tube Ø 5 mm WL 310 mm  | 5.0 mm  | 310 mm | <b>8383.913</b> |
| for use of 5 mm auxiliary instruments  |  |         |        |                 |
| <br>capacity 5.0 mm                               | Suction irrigation tube Ø 10 mm WL 225 mm  | 10.0 mm | 225 mm | <b>8385.942</b> |
|  | Suction irrigation tube Ø 10 mm WL 330 mm  | 10.0 mm | 330 mm | <b>8385.951</b> |
| <br>insulated,<br>with atraumatic preparation tip | Suction irrigation tube mono Ø 10 mm WL 330 mm   | 10.0 mm | 330 mm | <b>8385.944</b> |
|   | required for 8385.951:<br><b>Sealing attachment</b><br>with opening and membrane valve, sealing membrane Ø 17 mm |         |        | <b>8385.903</b> |

III23 || Subject to modifications. Please note that some products may not be available in all countries. Please always take note of the information that is provided with the product. For more detailed information, please consult with your contact partner or directly with Richard Wolf GmbH.

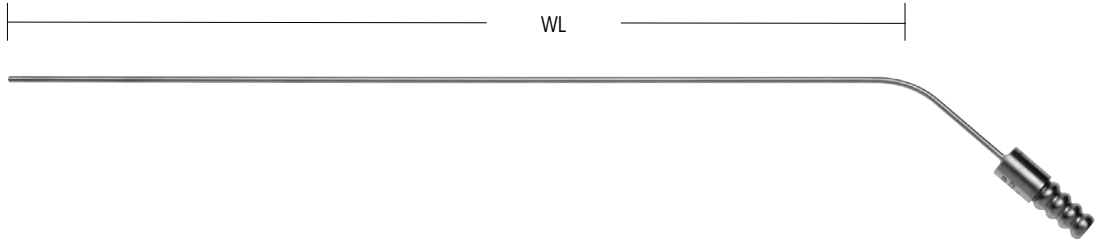

## ACCESSORIES FOR SUCTION AND IRRIGATION







|   |                                  | Outer Ø | WL     | Product no.    |
|---|----------------------------------|---------|--------|----------------|
| <br>central, lateral openings, rigid | suction tube OD 2 mm WL 250 mm   | 2.0 mm  | 250 mm | <b>8291.22</b> |
|   | suction tube OD 2.5 mm WL 250 mm | 2.5 mm  | 250 mm | <b>8291.23</b> |
|   | suction tube OD 3 mm WL 250 mm   | 3.0 mm  | 250 mm | <b>8291.24</b> |
|   | suction tube OD 4 mm WL 500 mm   | 4.0 mm  | 500 mm | <b>8291.45</b> |



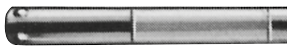

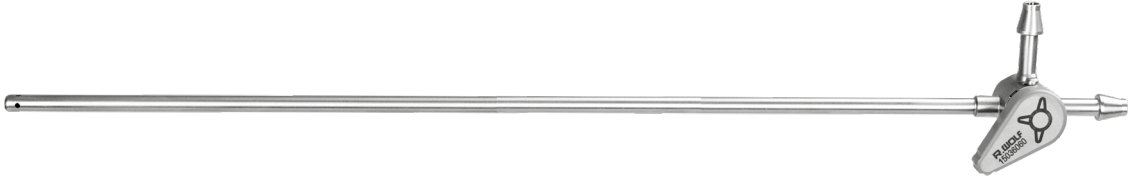
|   |                                  | Outer Ø | WL     | Product no.    |
|---|----------------------------------|---------|--------|----------------|
|  | Suction tube OD 2.8 mm WL 450 mm | 2.8 mm  | 450 mm | <b>8380.68</b> |

**ACCESSORIES**  
FOR SUCTION AND IRRIGATION

|  |  |                                       |           |                    |
|--|--|---------------------------------------|-----------|--------------------|
|            |  |                                       |           |                    |
|             | <b>Suction tube graduated <math>\varnothing</math> 5 mm WL 330 mm</b>  | <b>Outer <math>\varnothing</math></b> | <b>WL</b> | <b>Product no.</b> |
| graduated,<br>with 3 mm Luer connector   |  | 5.0 mm                                | 330 mm    | <b>8383.68</b>     |
|          |  |                                       |           |                    |
|           | <b>Suction irrigation tube <math>\varnothing</math> 5 mm WL 300 mm</b> | <b>Outer <math>\varnothing</math></b> | <b>WL</b> | <b>Product no.</b> |
| with stop valve  |  | 5.0 mm                                | 300 mm    | <b>8383.94</b>     |
|          |  |                                       |           |                    |
|           | <b>Suction irrigation tube WL 290 mm</b>                               | <b>Outer <math>\varnothing</math></b> | <b>WL</b> | <b>Product no.</b> |
| with maintenance-free two-way<br>stopcock,<br>sheath tube, with distal openings,<br>reusable | <b>Suction irrigation tube WL 410 mm</b>                               | 5.0 mm                                | 290 mm    | <b>8583732</b>     |
|  |  | 5.0 mm                                | 410 mm    | <b>8584732</b>     |

## ACCESSORIES / DISPOSABLE HAND BLOWER FOR SUCTION AND IRRIGATION



|   |   | Outer Ø | WL     | Product no.    |
|---|---|---------|--------|----------------|
|  | <b>Suction irrigation tube Ø 3 mm WL 300 mm</b> | 3.0 mm  | 330 mm | <b>8383.72</b> |
| with Luer connector   |   |         |        |                |



|   |  | Outer Ø | WL     | Product no.    |
|---|--|---------|--------|----------------|
|  | <b>HF coagulation suction device mono Ø 5 mm WL 315 mm</b> | 5.0 mm  | 315 mm | <b>8383.71</b> |
| with Luer connector and a valve   | <b>HF coagulation suction device mono Ø 5 mm WL 350 mm</b> | 5.0 mm  | 450 mm | <b>8384.71</b> |

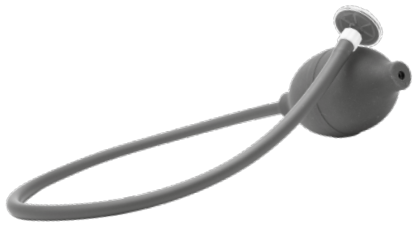

| for air insufflation  |  | Ø     | TL     | Product no.   |
|---|--|-------|--------|---------------|
|  | <b>Hand blower with disposable filter, sterile (PACK= 5 PCS)</b> | 49 mm | 567 mm | <b>412700</b> |

HF connection cable: see sheet BDE116/117

# TISSUE RETRACTOR 5 MM





|  |                                      | Outer Ø | WL     | Product no.     |
|--|--------------------------------------|---------|--------|-----------------|
|  | tissue retractor<br>Ø 5 mm WL 320 mm | 5.0 mm  | 320 mm | <b>8383.691</b> |

| Accessories      | Product no.   |
|------------------|---------------|
| Luer sealing cap | <b>887.00</b> |

III23 || Subject to modifications. Please note that some products may not be available in all countries. Please always take note of the information that is provided with the product. For more detailed information, please consult with your contact partner or directly with Richard Wolf GmbH.

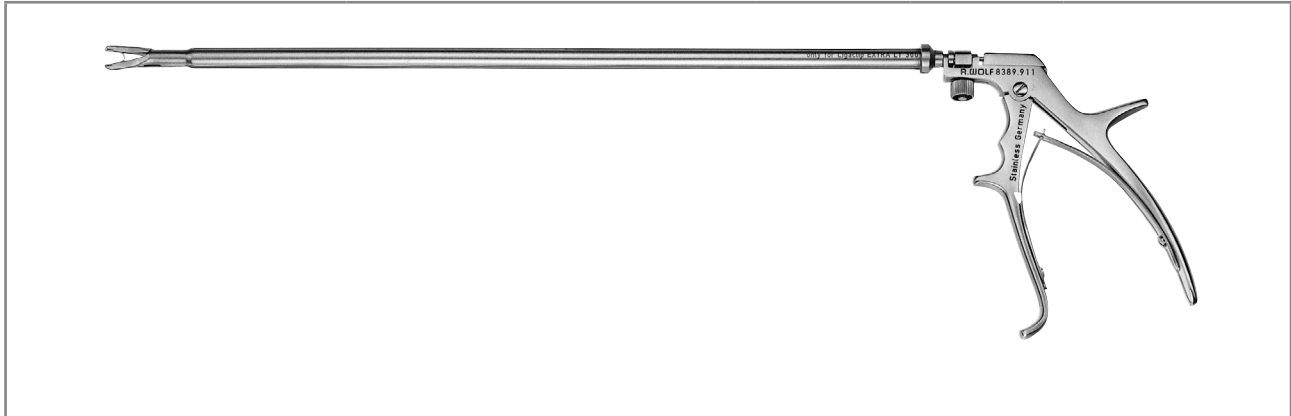
# CLIP APPLICATOR 10 MM FOR SUCTION AND IRRIGATION



|   |   | Outer Ø | WL     | Product no.        |
|---|---|---------|--------|--------------------|
|   | <b>Clip applicator</b><br>Ø 10 mm WL 340 mm                   | 10 mm   | 340 mm | <b>8389.911</b>    |
| <b>for this:</b>  |   |         |        | <b>Product no.</b> |
|  | <b>Introduction sleeve 10 mm WL 80 mm</b><br>with sealing cap |         |        | <b>8389.991</b>    |
| For clip ligation with Ethicon® Ligaclip® EXTRA LT 300                              |   |         |        |                    |
| <b>Ethicon® Ligaclips®</b><br>(PACK= 108 PCS)                                       |   |         |        | <b>8389.915</b>    |

| Accessories                      | Product no.  |
|----------------------------------|--------------|
| Sealing cap capacity 9.5–10.1 mm | <b>89.08</b> |

# ERAGON<sup>stitch</sup>

## THE ERGONOMIC GENERATION OF NEEDLE HOLDERS

Thanks to the custom combination options it offers, **ERAGON<sup>stitch</sup>** can accommodate any user requirement. The way in which it brings together ergonomics, versatility, modularity, and precision sets new standards in comfort

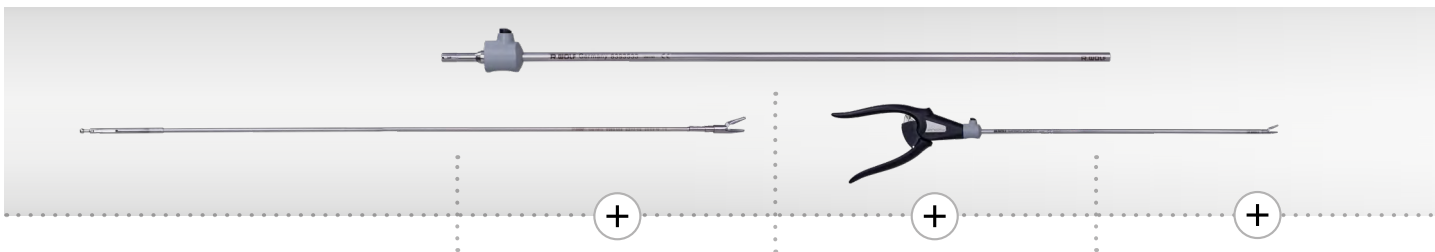

Choose working length

Choose jaw insert

Choose sheath tube

Choose handle





|                     |                          |  |  |  |
|---------------------|--------------------------|--|--|--|
| <p>∅<br/>5.0 mm</p> | <p>330 mm<br/>450 mm</p> |  |  |  |
| <p>∅<br/>3.5 mm</p> | <p>240 mm<br/>330 mm</p> |  |  |  |

**ERAGONstitch needle holders**



**ERAGON<sup>stitch</sup>**  
NEEDLE HOLDER Ø 3.5 MM



| Needle holder jaw insert  |       |   | Sheath tube, Ø 3.5 mm  |         | Needle holder handle  |         | Complete instrument<br>• Jaw insert<br>• Sheath tube<br>• Handle |
|---|-------|---|--|---------|---|---------|--|
|  |       |   |  |         |  |         |  |
|   |       |   |  |         |   |         | SL<br>240 mm   |
|   |       |   |  |         | Axial   | Angled  |  |
|   | JL*   | Product no.                               | 8390533  | 8391533 | 8393943   | 8393944 | Product no.  |
|  | 12 mm | Needle holder jaw insert<br>Ø 3.5 mm bndl | •  |         | •   |         | <b>83915053</b>  |
|   |       | 8391505                                   | •  |         |   | •       | <b>83915054</b>  |
| straight with carbide insert<br>single-action                                       |       | 8391506                                   |  | •       | •   |         | <b>83915063</b>  |
|   |       |   |  | •       |   | •       | <b>83915064</b>  |

\* JL = jaw length when jaw section closed (approximate measurements)





| Accessories for manual and machine reprocessing  | Product no.   |
|--|---------------|
| <br>Irrigation adapter cleaning<br>Ø 9 mm, length 64 mm<br>for uninsulated sheath tubes | <b>163503</b> |

1123 || Subject to modifications. Please note that some products may not be available in all countries. Please always take note of the information that is provided with the product. For more detailed information, please consult with your contact partner or directly with Richard Wolf GmbH.



# ERAGON<sup>stitch</sup>



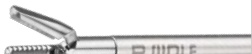

## NEEDLE HOLDER Ø 5.0 MM

| Needle holder jaw insert  |       |             | Sheath tube, Ø 5.0 mm   |         | Needle holder handle   |         | Complete instrument<br>• Jaw insert<br>• Sheath tube<br>• Handle |  |
|---|-------|-------------|---|---------|--|---------|--|--|
|    |       |             |  |         |  |         |  |  |
|   |       |             |   |         |  |         |  |  |
|   | JL*   | Product no. | 8393533   | 8394533 | 8393943  | 8393944 | Product no.  |  |
|   | 19 mm | 8393507     | •   |         | •  |         | 83935073   |  |
|   |       |             | •   |         |  | •       | 83935074   |  |
| straight with carbide insert<br>single-action                                       | 19 mm | 8394507     |   | •       | •  |         | 83945073   |  |
|   |       |             |   | •       |  | •       | 83945074   |  |
|  | 19 mm | 8393508     | •   |         | •  |         | 83935083   |  |
|   |       |             | •   |         |  | •       | 83935084   |  |
| straight and narrow with carbide<br>insert<br>single-action                         | 19 mm | 8394508     |   | •       | •  |         | 83945083   |  |
|   |       |             |   | •       |  | •       | 83945084   |  |
|  | 19 mm | 8393509     | •   |         | •  |         | 83935093   |  |
|   |       |             | •   |         |  | •       | 83935094   |  |
| straight,<br>with self-righting function<br>single-action                           | 19 mm | 8394509     |   | •       | •  |         | 83945093   |  |
|   |       |             |   | •       |  | •       | 83945094   |  |

\* JL = jaw length when jaw section closed (approximate measurements)

| Accessories for manual and machine reprocessing                                     |  | Product no.   |
|---|--|---------------|
|  | <b>Irrigation adapter cleaning</b><br>Ø 9 mm, length 64 mm<br>for uninsulated sheath tubes | <b>163503</b> |

**ERAGON** *stitch*  
NEEDLE HOLDER Ø 5.0 MM













| Needle holder jaw insert  |       |   | Sheath tube, Ø 5.0 mm   |         | Needle holder handle   |                   | Complete instrument<br>• Jaw insert<br>• Sheath tube<br>• Handle |
|---|-------|---|---|---------|--|-------------------|--|
|    |       |   |  |         |  |                   |  |
|   |       |   |   |         |  |                   |  |
|   | JL*   | Product no.                                       | 8393533   | 8394533 | Axial<br>8393943   | Angled<br>8393944 | Product no.  |
|   | 19 mm | Needle holder<br>Ø 5 mm bndl                      | •   |         | •  |                   | <b>83935183</b>  |
|   |       | curved right with carbide insert<br>single-action | •   |         |  | •                 | <b>83935184</b>  |
|   | 19 mm | 8394518   |   | •       | •  |                   | <b>83945183</b>  |
|   |       |   |   | •       |  | •                 | <b>83945184</b>  |
|  | 19 mm | Needle holder<br>Ø 5 mm bndl                      | •   |         | •  |                   | <b>83935193</b>  |
|   |       | Curved left with carbide insert<br>single-action  | •   |         |  | •                 | <b>83935194</b>  |
|   | 19 mm | 8394519   |   | •       | •  |                   | <b>83945193</b>  |
|   |       |   |   | •       |  | •                 | <b>83945194</b>  |

| Accessories for manual and machine reprocessing  | Product no.   |
|--|---------------|
| <br>Irrigation adapter cleaning<br>Ø 9 mm, length 64 mm<br>for uninsulated sheath tubes | <b>163503</b> |

1123 || Subject to modifications. Please note that some products may not be available in all countries. Please always take note of the information that is provided with the product. For more detailed information, please consult with your contact partner or directly with Richard Wolf GmbH.

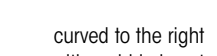
# NEEDLE HOLDER Ø 3.5 MM/5 MM

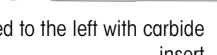
## MODULAR SYSTEM

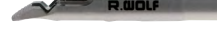

|  |             |        |        |  |                  |
|--|-------------|--------|--------|--|------------------|
|    |             |        |        |  |                  |
| <b>Needle holder jaw insert with sheath</b>  |             |        |        | <b>Needle holder handle, axial</b>   |                  |
|   |             |        |        |  |                  |
|  |             |        |        | single-action locking mechanism, can be disabled                                   |                  |
|  | Product no. | Ø      | SL     | 8393.941   | Product no.      |
| <br>with carbide insert                     | 8391504     | 3.5 mm | 340 mm | •  | <b>8391.501</b>  |
| <br>for straight needles                    | 8393504     | 5 mm   | 340 mm | •  | <b>8393.501</b>  |
| <br>with carbide insert                     | 8393505     | 5 mm   | 340 mm | •  | <b>8393.502</b>  |
| <br>with carbide insert                     | 8394505     | 5 mm   | 430 mm | •  | <b>8394.502</b>  |
| <br>curved to the right with carbide insert | 8393514     | 5 mm   | 340 mm | •  | <b>8393.511</b>  |
| <br>curved to the right with carbide insert | 8394514     | 5 mm   | 430 mm | •  | <b>8394.511</b>  |
| <br>curved to the left with carbide insert  | 8393515     | 5 mm   | 340 mm | •  | <b>8393.512</b>  |
| <br>curved to the left with carbide insert  | 8394515     | 5 mm   | 430 mm | •  | <b>8394.512</b>  |
| <br>Sarbu needle holder Ø 5 mm bndl         | 8393506     | 5 mm   | 340 mm | •  | <b>8393.503*</b> |
| <br>Sarbu needle holder Ø 5 mm bndl         | 8394506     | 5 mm   | 430 mm | •  | <b>8394.503*</b> |

\* with automatic needle placement apparatus and cutting edge

1123 || Subject to modifications. Please note that some products may not be available in all countries. Please always take note of the information that is provided with the product. For more detailed information, please consult with your contact partner or directly with Richard Wolf GmbH.

# NEEDLE HOLDER HANDLE







| Needle holder handle, axial   | not rotatable | with lock | without HF | Product no.     |
|---|---------------|-----------|------------|-----------------|
|  | •             | •         | •          | <b>8393.941</b> |



| Needle holder handle<br><small>ERAGON</small> <small>stitch</small>                 | axial | angled | with on-off<br>detent<br>mechanism | single-action | Not<br>rotatable | Product no.    |
|---|-------|--------|------------------------------------|---------------|------------------|----------------|
|   | •     |        | •                                  | •             | •                | <b>8393943</b> |
|  |       | •      | •                                  | •             | •                | <b>8393944</b> |

III23 || Subject to modifications. Please note that some products may not be available in all countries. Please always take note of the information that is provided with the product. For more detailed information, please consult with your contact partner or directly with Richard Wolf GmbH.

**ERAGON**<sub>modular</sub>

**MODULAR KNOT PUSHER Ø 5.0 MM, INSULATED**

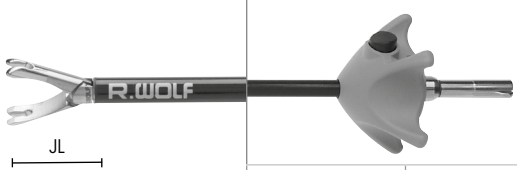
|  |                    | Handle, axial   |   |  |   |
|--|--------------------|---|---|--|---|
| <br>All jaw inserts and sheath tubes can also be combined with <b>ERAGONaxial</b> |                    |  |  |  |  |
|  |                    | with lock   | without lock, with HF connector   | without lock, with HF connector  | with lock, not rotatable  |
| <b>Rotatable knob</b>  | <b>Product no.</b> | 83930082  | 83930083  | 83930084   | 83930085  |
|   | 8988               | •   | •   | •  | •   |

| Jaw insert   |       | Sheath tube, Ø 5.0 mm, insulated |              | Handle   | Complete instrument<br>• Jaw insert with sheath tube<br>• Handle |                    |
|--|-------|----------------------------------|--------------|--|--|--------------------|
| <br><br>JL |       | SL<br>330 mm                     | SL<br>450 mm | <br>with lock, without HF |  |                    |
|  | JL*   | <b>Product no.</b>               | 8393933      | 8394933  | 83930072   | <b>Product no.</b> |
| <b>Knot pusher Ø 5 mm bndl</b>   | 17 mm | 8393.345                         | •            |  | •  | <b>83933457</b>    |
| with distal recess, double-action  |       | 8394345                          |              | •  | •  | <b>83943457</b>    |

KNOT PUSHER

11



\* JL = jaw length when jaw section closed (approximate measurements)

HF connection cable: see sheet BDE116/117

1123 || Subject to modifications. Please note that some products may not be available in all countries. Please always take note of the information that is provided with the product. For more detailed information, please consult with your contact partner or directly with Richard Wolf GmbH.

# KNOT PUSHER 5 MM FOR ENDOSCOPIC SUTURING



|   |   | Outer Ø | WL     | TL     | Product no.     |
|---|---|---------|--------|--------|-----------------|
|    | <b>Knot pusher Ø 3.7 mm WL 330 mm</b><br>for intraabdominal knots | 3.7 mm  | 330 mm | 380 mm | <b>8383.55</b>  |
|  | <b>Knot pusher Ø 3.7 mm WL 330 mm</b><br>for extracorporeal knots | 3.7 mm  | 330 mm | 380 mm | <b>8383.551</b> |





|   |   | Outer Ø | WL     | TL     | Product no.     |
|---|---|---------|--------|--------|-----------------|
|  | <b>Knot pusher Ø 5 mm WL 330 mm</b><br>as per Bueß<br>with distal notch and lateral opening<br>for optimum knotting, extremely atraumatic tip for use as a surgical probe | 5.0 mm  | 330 mm | 380 mm | <b>8383.552</b> |

|||23 || Subject to modifications. Please note that some products may not be available in all countries. Please always take note of the information that is provided with the product. For more detailed information, please consult with your contact partner or directly with Richard Wolf GmbH.

# Endoscopically controlled fascia closure system







## AS PER BUSCHE



|   |                                       | Product no. |        |             |
|---|---------------------------------------|-------------|--------|-------------|
|  <p>for subcutaneous fascia suture</p>           | Sealing cone Ø 10–12 mm               | 8934.915    |        |             |
|   | Sealing cone Ø 12–15 mm               | 8943.915    |        |             |
|   | Sealing cone Ø 15–20 mm               | 8945.915    |        |             |
|   |                                       | Ø           | WL     | Product no. |
|  <p>Needle forceps with active suture holder</p> | Needle forceps<br>Ø 2.45 mm WL 160 mm | 2.45 mm     | 160 mm | 8756.201    |

11123 || Subject to modifications. Please note that some products may not be available in all countries. Please always take note of the information that is provided with the product. For more detailed information, please consult with your contact partner or directly with Richard Wolf GmbH.

## CANNULAS 3.0 MM/4.7 MM

|   |  |                |                    |                    |
|---|--|----------------|--------------------|--------------------|
|                   |  |                |                    |                    |
| <b>with Luer connector</b>  |  | <b>Outer Ø</b> | <b>WL</b>          | <b>Product no.</b> |
| <br>Tip Ø 1.4 mm   | <b>Injection cannula Ø 3 mm WL 340 mm</b>  | 3.0 mm         | 340 mm             | <b>8379.732</b>    |
|                  |  |                |                    |                    |
| <b>with 3 mm Luer connector</b>   |  | <b>Ø</b>       | <b>WL</b>          | <b>Product no.</b> |
| <br>Tip Ø 1.8 mm | <b>Injection cannula Ø 4.7 mm WL 350 mm</b>  | 4.7 mm         | 350 mm             | <b>8383.65</b>     |
|                 |  |                |                    |                    |
| <b>with suction regulator and 4 mm Luer connector</b>   |  | <b>Ø</b>       | <b>WL</b>          | <b>Product no.</b> |
| <br>Tip Ø 1.8 mm | <b>Puncture cannula Ø 4.7 mm WL 320 mm</b>   | 4.7 mm         | 320 mm             | <b>8383.49</b>     |
| <b>for this:</b>  |  | <b>WL</b>      | <b>Product no.</b> |                    |
|                  | <b>Introduction sleeve size 5.5 mm WL 45 mm</b><br><br>This sleeve prevents damage to the cannula tip when the trocar sleeve valve is opened | 45 mm          | <b>8383.00</b>     |                    |



# SURGICAL PROBES



|   |  | Ø      | WL     | Product no.     |
|---|--|--------|--------|-----------------|
|  | <b>Surgical probe 3.5 mm WL 250 mm graduated</b> | 3.5 mm | 250 mm | <b>8379.672</b> |



|   |  | Ø      | WL     | Product no.    |
|---|--|--------|--------|----------------|
|   | <b>Surgical probe Ø 5 mm WL 328 mm graduated</b> | 5.0 mm | 328 mm | <b>8383.66</b> |
|  | <b>Surgical probe Ø 5 mm WL 448 mm graduated</b> | 5.0 mm | 448 mm | <b>8384.66</b> |

11123 || Subject to modifications. Please note that some products may not be available in all countries. Please always take note of the information that is provided with the product. For more detailed information, please consult with your contact partner or directly with Richard Wolf GmbH.

# MYOMA DRILL 5 MM/10 MM



|   |                              | Ø     | WL     | Product no.     |
|---|------------------------------|-------|--------|-----------------|
|  | Myoma drill Ø 5 mm WL 320 mm | 5 mm  | 320 mm | <b>8383.611</b> |
|   | Myoma drill Ø 10 mm          | 10 mm | 340 mm | <b>8385.301</b> |

III23 || Subject to modifications. Please note that some products may not be available in all countries. Please always take note of the information that is provided with the product. For more detailed information, please consult with your contact partner or directly with Richard Wolf GmbH.

# INSUFFLATOR HIGHFLOW 45 BASIC



|   |                | Product no.     |
|---|----------------|-----------------|
| <b>Insufflator 45 BASIC bndI</b><br>consisting of:<br>Insufflator 45 BASIC FR 45 l/min (2235001),<br>Insufflation tube set L 2.5 m (8170.101),<br>Hygiene filter, sterile, disposable (PACK= 10 PCS) (4171.111)<br>and power cable 3 m long (2440.03) |                | <b>22350011</b> |
| <b>Accessories: Tube sets for insufflation</b>  |                |                 |
| Insufflation tube set L 2.5 m, High Flow, D = 8 mm, autoclavable  |                | <b>8170.232</b> |
| Insufflation tube set L 2.5 m, autoclavable   |                | <b>8170.101</b> |
| Insufflation tube set L 2.7 m, with integrated hygiene filter, disposable, (PACK= 10 PCS) in individual sterile packaging   |                | <b>4170.501</b> |
| Hygiene filter, sterile, disposable (PACK= 10 PCS) in individual sterile packaging  |                | <b>4171.111</b> |
| <b>Accessories for gas supply</b>   |                |                 |
| CO <sub>2</sub> connection tube 1.5 m NIST-NIST   |                | <b>74021038</b> |
| with  |                |                 |
| Pressure reducer for CO <sub>2</sub> connector DIN 477-1  | DIN 477-1      | <b>74007054</b> |
| Pressure reducer for CO <sub>2</sub> connector DIN EN ISO 407   | DIN EN ISO 407 | <b>74007055</b> |
| Pressure reducer for CO <sub>2</sub> connector ISO 5145   | ISO 5145       | <b>74007056</b> |
| or  |                |                 |
| Connection tube for CO <sub>2</sub> 5.0 m DIN for centralized CO <sub>2</sub> gas supply (Dräger)   |                | <b>74021039</b> |
| Connection tube for CO <sub>2</sub> 5.0 m NF for centralized CO <sub>2</sub> gas supply (Liquid Air)  |                | <b>74021040</b> |
| <b>Software modules (optional)</b>  |                |                 |
| Software module CAN bus CAN bus interface for integration in CORE   |                | <b>2235101</b>  |
| Software module BABY MODE BABY MODE for special use in pediatrics   |                | <b>2235102</b>  |
| Software module VIDEO DISPLAY: video display using DIALOG via CAN bus   |                | <b>2235103</b>  |

# TECHNICAL DATA

## INSUFFLATOR HIGHFLOW 45 BASIC

| Insufflator 45 BASIC  |  | 2235001 |
|---|--|---------|
| <b>Device properties</b>  |  |         |
| Operating mode  | Continuous operation   |         |
| Operating conditions  | +10°C to +40°C, 30% to 75% rel. humidity, atmospheric pressure 700 hPa to 1,060 hPa              |         |
| Storage and transport conditions  | -20°C to +60°C, 10% to 90% rel. humidity, atmospheric pressure 700 hPa to 1,060 hPa              |         |
| <b>Power supply</b>   |  |         |
| Mains + frequency   | 100–240 V~, 50/60 Hz   |         |
| Power consumption   | 60 VA  |         |
| Current rating  | 0.6–0.2 A  |         |
| Fuse  | T 3.15 AH 250 V  |         |
| <b>Regulatory standards</b>   |  |         |
| Protection class to IEC/EN 60601-1 (UL 60601-1/CSA C222 No6011 – for USA) | I  |         |
| Electromagnetic compatibility (EMC)                                       | IEC/EN 60601-1-2   |         |
| Medical Devices Directive 93/42/EEC                                       | Class IIb  |         |
| Protection against electric shock   | Type CF applied part   |         |
| Degree of protection against the ingress of liquids                       | IP 20 (not protected)  |         |
| Degree of protection in the presence of flammable mixtures                | Device is not protected against explosions (do not operate this device in explosive atmospheres) |         |
| <b>Dimensions and weights</b>   |  |         |
| Weight  | 8.9 kg (19.5 lbs)  |         |
| Dimensions (W x H x D)  | 300 mm x 160 mm x 455 mm   |         |

| Relevant application parameters |  |
|---------------------------------|--|
| Insufflation medium             | Medical-grade CO <sub>2</sub> (degree of purity > 99.5%)           |
| Intraabdominal pressure         | 3 mmHg to 25 mmHg (± 2 mmHg)<br>selectable in increments of 1 mmHg |
| Gas flow rate primary filling   | 1 l/min (± 50%)  |
| Gas flow rate, High Flow        | 2 l/min to 45 l/min (± 20%)<br>selectable in increments of 1 l/min |
| Consumption indicator           | 0 l to 9,999 l (± 20%)   |

# INSUFFLATOR HIGHFLOW 45 EVAC WITH SMOKE GAS EVACUATION



|   |                | Product no.     |
|---|----------------|-----------------|
| <b>Insufflator 45 EVAC bndl</b><br>consisting of: Insufflator 45 EVAC FR 45 l/min (2235011),<br>Insufflation tube set L 2.5 m (8170.101),<br>Hygiene filter, sterile, disposable (PACK= 10 PCS) (4171.111),<br>Insufflation tube set L 2.7 m with integrated hygiene filter, sterile, disposable (PACK= 10 PCS) (4170.501)<br>Smoke gas evacuation tube set L 2.7 m, sterile, disposable (PACK= 10 PCS) (4170503)<br>Footswitch with 1 pedal (20301031) and power cable, 3 m long (2440.03) |                | <b>22350111</b> |
| <b>Accessories: Tube sets for insufflation</b>  |                |                 |
| Smoke gas evacuation tube set L 2.7 m, sterile, disposable (PACK= 10 PCS)   |                | <b>4170503</b>  |
| <b>Accessories for gas supply</b>   |                |                 |
| CO <sub>2</sub> connection tube 1.5 m NIST-NIST   |                | <b>74021038</b> |
| with  |                |                 |
| Pressure reducer for CO <sub>2</sub> connector DIN 477-1  | DIN 477-1      | <b>74007054</b> |
| Pressure reducer for CO <sub>2</sub> connector DIN EN ISO 407   | DIN EN ISO 407 | <b>74007055</b> |
| Pressure reducer for CO <sub>2</sub> connector ISO 5145   | ISO 5145       | <b>74007056</b> |
| or  |                |                 |
| Connection tube for CO <sub>2</sub> 5.0 m DIN for centralized CO <sub>2</sub> gas supply (Dräger)   |                | <b>74021039</b> |
| Connection tube for CO <sub>2</sub> 5.0 m NF for centralized CO <sub>2</sub> gas supply (Liquid Air)  |                | <b>74021040</b> |
| <b>Software modules (optional)</b>  |                |                 |
| Software module CAN bus CAN bus interface for integration in CORE   |                | <b>2235101</b>  |
| Software module BABY MODE BABY MODE for special use in pediatrics   |                | <b>2235102</b>  |
| Software module VIDEO DISPLAY: video display using DIALOG via CAN bus   |                | <b>2235103</b>  |

# TECHNICAL DATA

## INSUFFLATOR HIGHFLOW 45 EVAC

| Insufflator 45 EVAC   |  | 2235011 |
|---|--|---------|
| <b>Device properties</b>  |  |         |
| Operating mode  | Continuous operation   |         |
| Operating conditions  | +10°C to +40°C, 30% to 75% rel. humidity, atmospheric pressure 700 hPa to 1,060 hPa              |         |
| Storage and transport conditions  | -20°C to +60°C, 10% to 90% rel. humidity, atmospheric pressure 700 hPa to 1,060 hPa              |         |
| <b>Power supply</b>   |  |         |
| Mains + frequency   | 100–240 V~, 50/60 Hz   |         |
| Power consumption   | 60 VA  |         |
| Current rating  | 0.6–0.2 A  |         |
| Fuse  | T 3.15 AH 250 V  |         |
| <b>Regulatory standards</b>   |  |         |
| Protection class to IEC/EN 60601-1 (UL 60601-1/CSA C222 No6011 – for USA) | I  |         |
| Electromagnetic compatibility (EMC)                                       | IEC/EN 60601-1-2   |         |
| Medical Devices Directive 93/42/EEC                                       | Class IIb  |         |
| Protection against electric shock   | Type CF applied part   |         |
| Degree of protection against the ingress of liquids                       | IP 20 (not protected)  |         |
| Degree of protection in the presence of flammable mixtures                | Device is not protected against explosions (do not operate this device in explosive atmospheres) |         |
| <b>Dimensions and weights</b>   |  |         |
| Weight  | 8.9 kg (19.5 lbs)  |         |
| Dimensions (W x H x D)  | 300 mm x 160 mm x 455 mm   |         |

| Relevant application parameters |  |
|---------------------------------|--|
| Insufflation medium             | Medical-grade CO <sub>2</sub> (degree of purity > 99.5%)           |
| Intraabdominal pressure         | 3 mmHg to 25 mmHg (± 2 mmHg)<br>selectable in increments of 1 mmHg |
| Gas flow rate primary filling   | 1 l/min (± 50%)  |
| Gas flow rate, High Flow        | 2 l/min to 45 l/min (± 20%)<br>selectable in increments of 1 l/min |
| Consumption indicator           | 0 l to 9,999 l (± 20%)   |

# INSUFFLATOR HIGHFLOW 45 HEAT WITH GAS HEATING



|  |                | Product no.     |
|--|----------------|-----------------|
| <b>Insufflator 45 HEAT bndI</b><br>consisting of:<br>Insufflator 45 HEAT FR 45 L/min(2235021),<br>Insufflation tube for 2235021/031 L 3 m (8170202)<br>Hygiene filter, sterile, disposable (PACK= 10 PCS) (4171.111)<br>and power cable 3 m long (2440.03) |                | <b>22350211</b> |
| <b>Accessories: Tube sets for insufflation</b>   |                |                 |
| <b>Insufflation tube set L 3 m</b> Highflow, with heating wire and integrated hygiene filter, sterile, disposable, (PACK= 10 PCS) in individual sterile packaging  |                | <b>4170502</b>  |
| <b>Insufflation tube for 2235021/031 L 3 m</b> Highflow, with heating wire, autoclavable, 3.0 m<br>The reusable tube can be used up to 100 times   |                | <b>8170202</b>  |
| <b>Hygiene filter</b> , sterile, disposable (PACK= 10 PCS) in individual sterile packaging   |                | <b>4171.111</b> |
| <b>Accessories for gas supply</b>  |                |                 |
| <b>CO<sub>2</sub> connection tube 1.5 m NIST-NIST</b>  |                | <b>74021038</b> |
| with   |                |                 |
| <b>Pressure reducer for CO<sub>2</sub> connector DIN 477-1</b>   | DIN 477-1      | <b>74007054</b> |
| <b>Pressure reducer for CO<sub>2</sub> connector DIN EN ISO 407</b>  | DIN EN ISO 407 | <b>74007055</b> |
| <b>Pressure reducer for CO<sub>2</sub> connector ISO 5145</b>  | ISO 5145       | <b>74007056</b> |
| or   |                |                 |
| <b>Connection tube for CO<sub>2</sub> 5.0 m DIN</b> for centralized CO <sub>2</sub> gas supply (Dräger)  |                | <b>74021039</b> |
| <b>Connection tube for CO<sub>2</sub> 5.0 m NF</b> for centralized CO <sub>2</sub> gas supply (Liquid Air)   |                | <b>74021040</b> |
| <b>Software modules (optional)</b>   |                |                 |
| <b>Software module CAN bus</b> CAN bus interface for integration in CORE   |                | <b>2235101</b>  |
| <b>Software module BABY MODE</b> BABY MODE for special use in pediatrics   |                | <b>2235102</b>  |
| <b>Software module VIDEO DISPLAY:</b> video display using DIALOG via CAN bus   |                | <b>2235103</b>  |

# TECHNICAL DATA

## INSUFFLATOR HIGHFLOW 45 HEAT

| Insufflator 45 HEAT   |  | 2235021 |
|---|--|---------|
| <b>Device properties</b>  |  |         |
| Operating mode  | Continuous operation   |         |
| Operating conditions  | +10°C to +40°C, 30% to 75% rel. humidity, atmospheric pressure 700 hPa to 1,060 hPa              |         |
| Storage and transport conditions  | -20°C to +60°C, 10% to 90% rel. humidity, atmospheric pressure 700 hPa to 1,060 hPa              |         |
| <b>Power supply</b>   |  |         |
| Mains + frequency   | 100–127/220–240 V~, 50/60 Hz   |         |
| Power consumption   | 80 VA  |         |
| Current rating  | 0.8–0.3 A  |         |
| Fuse  | T 3.15 AH 250 V  |         |
| <b>Regulatory standards</b>   |  |         |
| Protection class to IEC/EN 60601-1 (UL 60601-1/CSA C222 No6011 – for USA) | I  |         |
| Electromagnetic compatibility (EMC)                                       | IEC/EN 60601-1-2   |         |
| Medical Devices Directive 93/42/EEC                                       | Class IIb  |         |
| Protection against electric shock   | Type CF applied part   |         |
| Degree of protection against the ingress of liquids                       | IP 20 (not protected)  |         |
| Degree of protection in the presence of flammable mixtures                | Device is not protected against explosions (do not operate this device in explosive atmospheres) |         |
| <b>Dimensions and weights</b>   |  |         |
| Weight  | 11.0 kg (23.3 lbs)   |         |
| Dimensions (W x H x D)  | 300 mm x 160 mm x 455 mm   |         |
| <b>Relevant application parameters</b>                                    |  |         |
| Insufflation medium   | Medical-grade CO <sub>2</sub> (degree of purity > 99.5%)   |         |
| Intraabdominal pressure   | 3 mmHg to 25 mmHg (± 2 mmHg)<br>selectable in increments of 1 mmHg                               |         |
| Gas flow rate primary filling   | 1 l/min (± 50%)  |         |
| Gas flow rate, High Flow  | 2 l/min to 45 l/min (± 20%)<br>selectable in increments of 1 l/min                               |         |
| Consumption indicator   | 0 l to 9,999 l (± 20%)   |         |



# INSUFFLATOR HIGHFLOW 45 EVAC + HEAT

## WITH SMOKE GAS EVACUATION AND GAS HEATING



|   |                | Product no.     |
|---|----------------|-----------------|
| <b>Insufflator 45 EVAC + HEAT bndl</b><br>consisting of: Insufflator 45 EVAC + HEAT FR 45 l/min(2235031),<br>Insufflation tube for 2235021/031 L 3 m (8170202),<br>Insufflation tube set L 3 m, sterile, disposable, (PACK= 10 PCS) (4170502),<br>Hygiene filter, sterile, disposable (PACK= 10 PCS) (4171.111),<br>Smoke gas evacuation tube set L 2.7 m, sterile, disposable (PACK= 10 PCS) (4170503)<br>Footswitch 1 pedal (20301031) and power cable 3 m long (2440.03) |                | <b>22350311</b> |
| <b>Accessories: Tube sets for insufflation</b>  |                |                 |
| <b>Insufflation tube set L 3 m</b> Highflow, with heating wire and integrated hygiene filter,<br>sterile, disposable, (PACK= 10 PCS) in individual sterile packaging  |                | <b>4170502</b>  |
| <b>Insufflation tube for 2235021/031 L 3 m</b> Highflow, with heating wire, autoclavable, 3.0 m<br>The reusable tube can be used up to 100 times  |                | <b>8170202</b>  |
| <b>Hygiene filter</b> , sterile, disposable (PACK= 10 PCS) in individual sterile packaging  |                | <b>4171.111</b> |
| <b>Smoke gas evacuation tube set L 2.7 m</b> , sterile, disposable (PACK= 10 PCS)   |                | <b>4170503</b>  |
| <b>Accessories for gas supply</b>   |                |                 |
| <b>CO<sub>2</sub> connection tube 1.5 m NIST-NIST</b>   |                | <b>74021038</b> |
| with  |                |                 |
| <b>Pressure reducer for CO<sub>2</sub> connector DIN 477-1</b>  | DIN 477-1      | <b>74007054</b> |
| <b>Pressure reducer for CO<sub>2</sub> connector DIN EN ISO 407</b>   | DIN EN ISO 407 | <b>74007055</b> |
| <b>Pressure reducer for CO<sub>2</sub> connector ISO 5145</b>   | ISO 5145       | <b>74007056</b> |
| or  |                |                 |
| <b>Connection tube for CO<sub>2</sub> 5.0 m DIN</b> for centralized CO <sub>2</sub> gas supply (Dräger)   |                | <b>74021039</b> |
| <b>Connection tube for CO<sub>2</sub> 5.0 m NF</b> for centralized CO <sub>2</sub> gas supply (Liquid Air)  |                | <b>74021040</b> |
| <b>Software modules (optional)</b>  |                |                 |
| <b>Software module CAN bus</b> CAN bus interface for integration in CORE  |                | <b>2235101</b>  |
| <b>Software module BABY MODE</b> BABY MODE for special use in pediatrics  |                | <b>2235102</b>  |
| <b>Software module VIDEO DISPLAY:</b> video display using DIALOG via CAN bus  |                | <b>2235103</b>  |

# TECHNICAL DATA

## INSUFFLATOR HIGHFLOW 45 EVAC + HEAT

| Insufflator 45 EVAC + HEAT  |  | 2235031 |
|---|--|---------|
| <b>Device properties</b>  |  |         |
| Operating mode  | Continuous operation   |         |
| Operating conditions  | +10°C to +40°C, 30% to 75% rel. humidity, atmospheric pressure 700 hPa to 1,060 hPa              |         |
| Storage and transport conditions  | -20°C to +60°C, 10% to 90% rel. humidity, atmospheric pressure 700 hPa to 1,060 hPa              |         |
| <b>Power supply</b>   |  |         |
| Mains + frequency   | 100–127/220–240 V~, 50/60 Hz   |         |
| Power consumption   | 80 VA  |         |
| Current rating  | 0.8–0.3 A  |         |
| Fuse  | T 3.15 AH 250 V  |         |
| <b>Regulatory standards</b>   |  |         |
| Protection class to IEC/EN 60601-1 (UL 60601-1/CSA C222 No6011 – for USA) | I  |         |
| Electromagnetic compatibility (EMC)                                       | IEC/EN 60601-1-2   |         |
| Medical Devices Directive 93/42/EEC                                       | Class IIb  |         |
| Protection against electric shock   | Type CF applied part   |         |
| Degree of protection against the ingress of liquids                       | IP 20 (not protected)  |         |
| Degree of protection in the presence of flammable mixtures                | Device is not protected against explosions (do not operate this device in explosive atmospheres) |         |
| <b>Dimensions and weights</b>   |  |         |
| Weight  | 11.0 kg (23.3 lbs)   |         |
| Dimensions (W x H x D)  | 300 x 160 x 455 mm   |         |

| Relevant application parameters |  |
|---------------------------------|--|
| Insufflation medium             | Medical-grade CO <sub>2</sub> (degree of purity > 99.5%)           |
| Intraabdominal pressure         | 3 mmHg to 25 mmHg (± 2 mmHg)<br>selectable in increments of 1 mmHg |
| Gas flow rate primary filling   | 1 l/min (± 50%)  |
| Gas flow rate, High Flow        | 2 l/min to 45 l/min (± 20%)<br>selectable in increments of 1 l/min |
| Consumption indicator           | 0 l to 9,999 l (± 20%)   |

# LAPARO-CO<sub>2</sub>-PNEU 2233



|  |                | Product no.     |
|--|----------------|-----------------|
| <b>LAPARO-CO<sub>2</sub>-PNEU bndl</b><br>consisting of:<br>LAPARO-CO2-PNEU 2233 FR 20 L/MIN (2233.001)<br>Insufflation tube set L 2.5 m (8170.101),<br>Hygiene filter, sterile, disposable (PACK= 10 PCS) (4171.111),<br>and power cable 3 m long (2440.03) |                | <b>22330011</b> |
| <b>Accessories: Tube sets for insufflation</b>   |                |                 |
| <b>Insufflation tube set, L 2.7 m</b><br>with integrated hygiene filter, sterile, disposable, (PACK= 10 PCS) in individual sterile packaging   |                | <b>4170.501</b> |
| <b>Accessories for gas supply</b>  |                |                 |
| <b>CO<sub>2</sub> connection tube 1.5 m NIST-NIST</b>  |                | <b>74021038</b> |
| with   |                |                 |
| <b>Pressure reducer for CO<sub>2</sub> connector DIN 477-1</b>   | DIN 477-1      | <b>74007054</b> |
| <b>Pressure reducer for CO<sub>2</sub> connector DIN EN ISO 407</b>  | DIN EN ISO 407 | <b>74007055</b> |
| <b>Pressure reducer for CO<sub>2</sub> connector ISO 5145</b>  | ISO 5145       | <b>74007056</b> |
| or   |                |                 |
| <b>Connection tube for CO<sub>2</sub> 5.0 m DIN for centralized CO<sub>2</sub> gas supply (Dräger)</b>   |                | <b>74021039</b> |
| <b>Connection tube for CO<sub>2</sub> 5.0 m NF for centralized CO<sub>2</sub> gas supply (Liquid Air)</b>  |                | <b>74021040</b> |



# TECHNICAL DATA

## LAPARO-CO<sub>2</sub>-PNEU 2233

| LAPARO-CO <sub>2</sub> -PNEU 2233   |  | 2233.001 |
|---|--|----------|
| <b>Device properties</b>  |  |          |
| Operating mode  | Continuous operation   |          |
| Operating conditions  | +10°C to +40°C, 30% to 75% rel. humidity, atmospheric pressure 700 hPa to 1,060 hPa              |          |
| Storage and transport conditions  | -20°C to +60°C, 10% to 90% rel. humidity, atmospheric pressure 700 hPa to 1,060 hPa              |          |
| <b>Power supply</b>   |  |          |
| Mains + frequency   | 100–230 V~, 50/60 Hz   |          |
| Power consumption   | 80 VA  |          |
| Current rating  | 0.8 A  |          |
| Fuse  | T 2 AL 250 V   |          |
| <b>Regulatory standards</b>   |  |          |
| Protection class to IEC/EN 60601-1 (UL 60601-1/CSA C222 No6011 – for USA) | I  |          |
| Electromagnetic compatibility (EMC)                                       | EN/IEC 60601--1--2   |          |
| Medical Devices Directive 93/42/EEC                                       | Class IIb  |          |
| Protection against electric shock   | Type CF applied part   |          |
| Degree of protection against the ingress of liquids                       | IP 20 (not protected)  |          |
| Degree of protection in the presence of flammable mixtures                | Device is not protected against explosions (do not operate this device in explosive atmospheres) |          |
| Maximum suction vacuum  | -60 kPa  |          |
| <b>Dimensions and weights</b>   |  |          |
| Weight  | 9.5 kg   |          |
| Dimensions (W x H x D)  | 330 mm x 155 mm x 390 mm   |          |

| Relevant application parameters |  |
|---------------------------------|--|
| Insufflation medium             | Medical-grade CO <sub>2</sub> (degree of purity > 99.5%)           |
| Intraabdominal pressure         | 3 mmHg to 25 mmHg (± 2 mmHg)<br>selectable in increments of 1 mmHg |
| Gas flow rate primary filling   | 1 l/min (± 50%)  |
| Gas flow rate, High Flow        | 2 l/min to 20 l/min (± 20%)<br>selectable in increments of 1 l/min |
| Consumption indicator           | 0 l to 9,999 l (± 20%)   |

## STERILE SMOKE SET FOR SMOKE GAS DISCHARGE

|   |                                 |
|---|---------------------------------|
|   |                                 |
| <b>Product no.</b>  |                                 |
| <p><b>Smoke set</b><br/>smoke filter with tube (PACK= 10 PCS) in individual sterile packaging</p>   | <p><b>2200/47BDKBTUA123</b></p> |

||24|| Subject to modifications. Please note that some products may not be available in all countries. Please always take note of the information that is provided with the product. For more detailed information, please consult with your contact partner or directly with Richard Wolf GmbH.

# FLUID CONTROL 2225

## SUCTION IRRIGATION PUMP

core



|   |  | Product no.     |
|---|--|-----------------|
| FLUID CONTROL 2225<br><b>Irrigation pump for Hys/Uro/Lap bndl</b><br>consisting of:<br>Irrigation pump for Hys/Uro/Lap (2225001)<br>and power cable 3 m long (2440.03)  |  | <b>22250011</b> |
| <b>for this:</b>  |  |                 |
| <b>Balancing module</b><br>for hysteroscopy and endourology,<br>fluid management for fluid balancing in combination with FLUID CONTROL 2225,<br>mobile stand with integrated weighing cells and space for up to 4 irrigation fluid bags |  | <b>2225023</b>  |

| Accessories       |  | Product no.    |
|-------------------|--|----------------|
| <b>Footswitch</b> | only for use in urology and within the indication TUR/enucleation, possibility of short-term increase in pressure if visibility is poor (Flush function) | <b>2204901</b> |

III23 || Subject to modifications. Please note that some products may not be available in all countries. Please always take note of the information that is provided with the product. For more detailed information, please consult with your contact partner or directly with Richard Wolf GmbH.

# FLUID CONTROL 2225

## SUCTION IRRIGATION TUBE SETS

| Irrigation  |   |  | Product no.    |
|---|---|--|----------------|
| <b>Accessories – reusable</b>   | <b>Tube set with piercing spike</b>                   | with Luer-Lock connection, autoclavable, incl. 10 spare membranes, reusable for 20 reprocessing cycles | <b>8171223</b> |
| <b>Accessories – disposable</b>   | <b>Irrigation tube set with piercing spike, L 3 m</b> | (PACK= 10 PCS), with Luer-Lock connection, sterile, disposable product                                 | <b>4171223</b> |
|   | <b>Tube set with CARE-LOCK, L 3 m</b>                 | (PACK= 10 PCS), sterile, disposable product  | <b>4171224</b> |
|   | <b>Suction irrigation tube set</b>                    | (PACK= 10 PCS), with piercing spike, sterile disposable product, PVC                                   | <b>4171225</b> |
|   | <b>Day irrigation tube set</b>                        | (PACK= 10 PCS), sterile, disposable product, PVC   | <b>4171226</b> |
|   | <b>Patient irrigation tube set, sterile</b>           | (PACK= 10 PCS), with Luer-Lock connection, sterile, disposable product, PVC                            | <b>4171227</b> |
| <i>Note: Day tube and patient tube can only be used together. A new patient tube is required for each patient; the day tube can be used for up to 20 patients</i> |   |  |                |

| Suction                         |  |  | Product no.      |
|---------------------------------|--|--|------------------|
| <b>Accessories – reusable</b>   | <b>Tube set for vacuum, incl. filter</b>       | with integrated hygiene filter, PACK= 10 PCS, service life: 30 days (connected to irrigation pump) | <b>2206207</b>   |
|                                 | <b>Irrigation tube</b>                         | L 1.2 m, with Luer-Lock, for suction irrigation handle 8385.901 and tube set 8171223 or 8170.223   | <b>817123</b>    |
|                                 | <b>Suction tube L 3 m</b>                      | for suction irrigation handle 8385.901   | <b>8171402</b>   |
|                                 | <b>Secretion container, 2 l</b>                | 2 liters, with lid   | <b>8170.655</b>  |
|                                 | <b>Secretion container, 2 l</b>                | 2 liters, no lid   | <b>8170.6551</b> |
| <b>Accessories – disposable</b> | <b>Secretion container, 2.5 l</b>              | 2.5 liters   | <b>41706566</b>  |
|                                 | <b>Secretion container bndl consisting of:</b> | Secretion container 2.5 l (41706566) and secretion bag (PACK= 90 PCS) (41706564)                   | <b>4170657</b>   |
|                                 | <b>Tube set for suction (2 connections)</b>    | sterile, disposable product, (PACK= 10 PCS) for connecting instruments to collecting container     | <b>T0503-01</b>  |
|                                 | <b>Angled 90° plug-in coupling</b>             | (PACK= 10 PCS) For connecting vacuum tube 2206207 to disposable container systems                  | <b>0771019</b>   |

# FLUID CONTROL 2225

## CABLE ACCESSORIES

|                                   |                    | Product no.     |
|-----------------------------------|--------------------|-----------------|
| Patch cable, RJ45 SFTP, 0.5 m     | Cable length 0.5 m | <b>72325378</b> |
| Patch cable, RJ45 HRS TM11, 1.0 m | Cable length 1.0 m | <b>72325429</b> |
| Patch cable, RJ45 S/FTP CAT6 10 m | Cable length 10 m  | <b>72325434</b> |
| Plastic caps for network socket   | (PACK= 8 PCS)      | <b>5592105</b>  |
| Power cable                       | Cable length 3 m   | <b>2440.03</b>  |

III23 || Subject to modifications. Please note that some products may not be available in all countries. Please always take note of the information that is provided with the product. For more detailed information, please consult with your contact partner or directly with Richard Wolf GmbH.



# TECHNICAL DATA

## FLUID CONTROL 2225

| FLUID CONTROL 2225   |             | 2225001  |
|--|-------------|--|
| <b>Device properties</b>                                   |             |  |
| Operating conditions                                       |             | +10°C to +40°C, 30% to 75% rel. humidity, 70 to 106 kPa atmospheric pressure<br>3,000 m max. altitude above sea level                    |
| Storage and transport conditions                           |             | -20°C to +60°C, 10% to 90% rel. humidity 70 to 106 kPa atmospheric pressure  |
| <b>Power supply</b>  |             |  |
| Mains + frequency  |             | 100–240 V~, 50/60 Hz   |
| Power consumption  | 100 V/60 Hz | 110 VA   |
|  | 240 V/50 Hz | 120 VA   |
| Current rating   | 100 V/60 Hz | 1.10 A   |
|  | 240 V/50 Hz | 0.50 A   |
| Fuse   |             | T 3.15 AH, 250 V   |
| <b>Regulatory standards</b>                                |             |  |
| Protection class (I, II)                                   |             | I  |
| Electromagnetic compatibility (EMC)                        |             | EN 60601-1/IEC 60601-1<br>EN 60601-1-2/IEC 60601-1-2   |
| Medical Devices Directive 93/42/EEC                        |             | Class IIb  |
| Housing protection rating (IP code)                        |             | IP21   |
| Protection against electric shock                          |             | Type BF applied part   |
| Degree of protection in the presence of flammable mixtures |             | Device is not protected against explosions<br>(do not operate this device in explosive atmospheres)                                      |
| Maximum suction vacuum                                     |             | -60 kPa  |
| <b>Dimensions and weights</b>                              |             |  |
| Weight   |             | 8.8 kg   |
| Dimensions (W x H x D)                                     |             | 300 mm x 157 mm x 436 mm   |
| <b>Relevant application parameters</b>                     |             |  |
| Nominal flow range   |             | Hysteroscopy: 800 ml/min (max. flow, not adjustable)<br>Endourology: 10–800 ml/min (max. flow)<br>Laparoscopy: 0.1–1.8 l/min (max. flow) |
| Suction power  |             | max. 2 l/min   |
| Starting nominal pressure range                            |             | Hysteroscopy: 15–200 mmHg<br>Endourology: 15–90 mmHg/20–120 cmH2O<br>Laparoscopy: 300 mmHg (not adjustable)                              |
| Pressure   |             | 0–300 mmHg   |
| Deficit  |             | -9,990 to +9,990 ml/0 to 99.9 l  |

# TECHNICAL DATA

## FLUID CONTROL 2225

| <b>Balancing module</b>             |   | <b>2225023</b> |
|-------------------------------------|---|----------------|
| <b>Device properties</b>            |   |                |
| Operating conditions                | +10°C to +40°C, 30% to 75% rel. humidity, 70 to 106 kPa atmospheric pressure<br>3,000 m max. altitude above sea level |                |
| Storage and transport conditions    | -20°C to +60°C , 10% to 90% rel. humidity 70 to 106 kPa atmospheric pressure  |                |
| <b>Regulatory standards</b>         |   |                |
| Electromagnetic compatibility (EMC) | EN 60601-1/IEC 60601-1<br>EN 60601-1-2/IEC 60601-1-2  |                |
| Housing protection rating (IP code) | IP21  |                |
| Maximum load of container scale     | 16 kg/4 containers of 3 l each  |                |
| Maximum load of bag scale           | 23 kg/4 bags of 5 l each  |                |
| <b>Dimensions and weights</b>       |   |                |
| Weight                              | 15.4 kg   |                |
| Dimensions (W x H x D)              | 618 mm x 1,064 mm x 618 mm  |                |

| <b>Footswitch</b>                   |                          | <b>2204901</b> |
|-------------------------------------|--------------------------|----------------|
| <b>Power supply</b>                 |                          |                |
| Power supply connection             | max. 24 V                |                |
| Power consumption                   | max. 0.1 A               |                |
| <b>Regulatory standards</b>         |                          |                |
| Electromagnetic compatibility (EMC) | EN 60601-1/IEC 60601-1   |                |
| Housing protection rating (IP code) | IPX8                     |                |
| Plug                                | 7-pin circular connector |                |
| Cable length                        | 4.5 m                    |                |
| <b>Dimensions and weights</b>       |                          |                |
| Weight                              | 300 g                    |                |
| Dimensions (W x H x D)              | 66 mm x 27 mm x 91 mm    |                |

# FLUID CONTROL LAP 2216

|  |                 |
|--|-----------------|
|   |                 |
| <b>Product no.</b>   |                 |
| <p>FLUID CONTROL<br/> <b>LAP suction irrigation pump bndl</b><br/>                 consisting of:<br/>                 LAP suction irrigation pump (2216001)<br/>                 and power cable 3 m long (2440.03)</p> | <b>22160011</b> |

| <b>Accessories</b>      |   | <b>Product no.</b> |
|-------------------------|---|--------------------|
| <b>Bracket</b>          | for fixing the suction container on the irrigator stand or MUT cart | <b>2215.992</b>    |
| <b>Universal holder</b> | for FLUID CONTROL LAP on RIWomobil                                  | <b>32114605</b>    |

1123 | Subject to modifications. Please note that some products may not be available in all countries. Please always take note of the information that is provided with the product. For more detailed information, please consult with your contact partner or directly with Richard Wolf GmbH.

# LAP SUCTION IRRIGATION PUMP 2216

## SUCTION IRRIGATION TUBE SETS

| Irrigation  |  |  | Product no.    |
|---|--|--|----------------|
| Accessories<br>– reusable   | Tube set with piercing spike                   | with Luer-Lock connection, autoclavable, incl. 10 spare membranes, reusable for 20 reprocessing cycles | <b>8171223</b> |
|   | Irrigation tube set with piercing spike, L 3 m | (PACK= 10 PCS), with Luer-Lock connection, sterile, disposable product                                 | <b>4171223</b> |
| Accessories<br>– disposable   | Tube set with CARE-LOCK, L 3 m                 | (PACK= 10 PCS), sterile, disposable product  | <b>4171224</b> |
|   | Suction irrigation tube set                    | (PACK= 10 PCS), with piercing spike, sterile disposable product, PVC                                   | <b>4171225</b> |
|   | Day irrigation tube set                        | (PACK= 10 PCS), sterile, disposable product, PVC   | <b>4171226</b> |
|   | Patient irrigation tube set, sterile           | (PACK= 10 PCS), with Luer-Lock connection, sterile, disposable product, PVC                            | <b>4171227</b> |
| <i>Note: Day tube and patient tube can only be used together. A new patient tube is required for each patient; the day tube can be used for up to 20 patients</i> |  |  |                |

| Suction                     |   |  | Product no.      |
|-----------------------------|---|--|------------------|
| Accessories<br>– reusable   | Tube set for vacuum, incl. filter       | with integrated hygiene filter, PACK= 10 PCS, service life: 30 days (connected to irrigation pump) | <b>2206207</b>   |
|                             | Irrigation tube                         | L 1.2 m, with Luer-Lock, for suction irrigation handle 8385.901 and tube set 8171223 or 8170.223   | <b>817123</b>    |
|                             | Suction tube L 3 m                      | for suction irrigation handle 8385.901   | <b>8171402</b>   |
|                             | Secretion container, 2 l                | 2 liters, with lid   | <b>8170.655</b>  |
|                             | Secretion container, 2 l                | 2 liters, no lid   | <b>8170.6551</b> |
| Accessories<br>– disposable | Secretion container, 2.5 l              | 2.5 liters   | <b>41706566</b>  |
|                             | Secretion container bndl consisting of: | Secretion container 2.5 l (41706566) and secretion bag (PACK= 90 PCS) (41706564)                   | <b>4170657</b>   |
|                             | Tube set for suction (2 connections)    | sterile, disposable product, (PACK= 10 PCS) for connecting instruments to collecting container     | <b>T0503-01</b>  |
|                             | Angled 90° plug-in coupling             | (PACK= 10 PCS) For connecting vacuum tube 2206207 to disposable container systems                  | <b>0771019</b>   |

# TECHNICAL DATA

## FLUID CONTROL LAP 2216

| LAP suction irrigation pump                                |  | 2216001 |
|--|--|---------|
| <b>Device properties</b>                                   |  |         |
| Operating conditions                                       | +10°C to +40°C, 30% to 75% rel. humidity, atmospheric pressure 700 hPa to 1,060 hPa<br>3,000 m max. altitude above sea level |         |
| Storage conditions   | +5°C to +40°C, 5% to 90% rel. humidity, atmospheric pressure 700 hPa to 1,060 hPa  |         |
| Transport and shipping conditions                          | -20°C to +60°C, 5% to 90% rel. humidity, atmospheric pressure 700 hPa to 1,060 hPa   |         |
| <b>Power supply</b>  |  |         |
| Mains + frequency  | 100–240 V~, 50/60 Hz   |         |
| Power consumption  | 100 V/60 Hz  | 65 VA   |
|  | 240 V/50 Hz  | 96 VA   |
| Current rating   | 100 V/60 Hz  | 0.65 A  |
|  | 240 V/50 Hz  | 0.42 A  |
| Protection class   | I  |         |
| Electromagnetic compatibility (EMC)                        | IEC 60601-1/EN 60601-1<br>IEC 60601-1-2/EN 60601-1-2   |         |
| Medical Devices Directive 93/42/EEC                        | Class IIa  |         |
| Protection against electric shock                          | Type BF applied part   |         |
| Degree of protection against the ingress of liquids        | IP 41  |         |
| Degree of protection in the presence of flammable mixtures | Device is not protected against explosions<br>(do not operate this device in explosive atmospheres)                          |         |
| <b>Dimensions and weights</b>                              |  |         |
| Weight   | 4 kg   |         |
| Dimensions (W x H x D) with toggle screw                   | 140 mm x 210 mm x 295 mm   |         |

| Relevant application parameters |   |
|---------------------------------|---|
| Maximum delivery rate           | Rinsing: 2.0 l/min ( $\pm$ 10%), suction: 2.0 l/min (+0.4/-0.1 l/min) |
| Maximum pump pressure           | 400 mmHg ( $\pm$ 50 mmHg)   |
| Motor cut-out                   | 500 mmHg after 5 s ( $\pm$ 25 mmHg)                                   |
| Suction pressure                | between -50 kPa and -60 kPa   |
| Connections                     | Equipotential bonding, vacuum connection                              |

# HF GENERATOR 2260

core

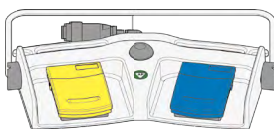

|                               |   | Product no. |
|-------------------------------|---|-------------|
| HF surgical generator 400 kHz | for the connection of monopolar and bipolar accessories, international version (BOWA, KLS Martin, Olympus, Karl Storz, Valleylab) | 2260001     |
| HF surgical generator 400 kHz | for the connection of monopolar and bipolar accessories, E version (Erbe)   | 2260002     |

| Accessories required   | Cable length | Product no. |
|--|--------------|-------------|
| <b>Footswitch, 2 pedals L 5 m</b><br>with fixed connection cable, reusable  |              | 2260021     |
| <b>Neutral electrode</b><br>for use with high-frequency surgical device,<br>Foil bag with 5 neutral electrodes, (PACK= 50 PCS)                                 |              | 1280H       |
| <b>Mono HF neutral electrode cable, L 4.5 m</b>  | 4.5 m        | 2260031     |
| <b>Power cable</b>   | 3.0 m        | 2440.03     |
| <b>Bipo HF connection cable L 3 m</b>  | 3.0 m        | 8108233     |
| <b>Bipo HF connection cable L 5 m</b>  | 5.0 m        | 8108253     |







III23 || Subject to modifications. Please note that some products may not be available in all countries. Please always take note of the information that is provided with the product. For more detailed information, please consult with your contact partner or directly with Richard Wolf GmbH.

# HF GENERATOR 2260

## TECHNICAL DATA

| HF surgical generator 400kHz  |                       | 2260001/2260002   |
|---|-----------------------|---|
| <b>Device properties</b>  |                       |   |
| Type of controls on housing front   |                       | Touch panel   |
| Output power  | max.cutting power     | 400 W   |
|   | max.coagulation power | 350 W   |
| LF and HF leakage currents  |                       | acc. to DIN EN 60601 1 and DIN EN 60601 2 2   |
| Signal level  |                       | HF indicator 55 dB(A); adjustable 45–60 dB(A)<br>Alarm 65 dB(A)                                     |
| Operating conditions  |                       | +10°C to +40°C, 30% to 75% rel humidity, 700 hPa to 1,060 hPa atmospheric pressure                  |
| Storage and transport conditions  |                       | - 20°C to + 60°C, 10% to 90% rel humidity, 700 hPa to 1,060 hPa atmospheric pressure                |
| <b>Power supply</b>   |                       |   |
| Mains + frequency   |                       | 100–240 V~, 50/60 Hz  |
| Power consumption   | without HF output     | 45 VA   |
|   | at max. output power  | 650 VA  |
| Current rating  |                       | max. 6.3 A  |
| Fuse  |                       | T 6.3 AH 250 V  |
| <b>Regulatory standards</b>   |                       |   |
| Protection class to EN/IEC 60601-1<br>(UL 2601-1/CSA C222 No6011 – for USA) |                       | I   |
| Electromagnetic compatibility (EMC)   |                       | EN/IEC 60601-1-2  |
| Medical Devices Directive 93/42/EEC   |                       | Class IIb   |
| Degree of protection against the ingress of liquids<br>(DIN EN/IEC 60529)   |                       | IPX0  |
| Degree of protection against the ingress of solids                          |                       | IP2X  |
| Duty factor (duty cycle DC)   |                       | Intermittent INT 10 s/30 s corresponding to 25% DC  |
| Protection against electric shock   |                       | Model CF applied part, defibrillator-proof  |
| Degree of protection in the presence of flammable mixtures                  |                       | Device is not protected against explosions<br>(do not operate this device in explosive atmospheres) |
| <b>Dimensions and weights</b>   |                       |   |
| Weight  |                       | 10.2 kg (22.4 lbs)  |
| Dimensions (W x H x D)  |                       | 300 x 159 x 419 mm  |

# HF CONNECTION CABLE MONO 815xxx

| Instrument connector   | Device connector   |                                   | Product no.    |
|--|--|-----------------------------------|----------------|
| <b>WOLF Resectoscopes</b><br>         | <br>ERBE (ACC/ICC/IO)/BOWA (EU)<br>R. Wolf HF surgical generator 400 kHz<br>2260002                                       | HF connection cable<br>mono L 3 m | <b>815.032</b> |
|  |  | HF connection cable<br>mono L 5 m | <b>815.052</b> |
|  | <br>ERBE (T series)   | HF connection cable<br>mono L 3 m | <b>815.132</b> |
|  |  | HF connection cable<br>mono L 5 m | <b>815.152</b> |
| <b>HF electrodes, monopolar</b><br> | <br>Martin (M-version)/Berchtold/<br>Aesculap   | HF connection cable<br>mono L 3 m | <b>815.031</b> |
|  |  | HF connection cable<br>mono L 5 m | <b>815.051</b> |
|  | <br>Bovie/Valleylab/Erbe (Int.)/<br>BOWA (Int.)<br>R. Wolf HF surgical generator 400 kHz<br>2260001                     | HF connection cable<br>mono L 3 m | <b>815.033</b> |
|  |  | HF connection cable<br>mono L 5 m | <b>815.053</b> |
|  | <br>BOWA (Int./EU)<br>Eschmann and other devices with<br>4 mm plugs<br>R. Wolf HF surgical generator 400 kHz<br>2260001 | HF connection cable<br>mono L 3 m | <b>815.034</b> |
|  |  | HF connection cable<br>mono L 5 m | <b>815.054</b> |

III23 || Subject to modifications. Please note that some products may not be available in all countries. Please always take note of the information that is provided with the product. For more detailed information, please consult with your contact partner or directly with Richard Wolf GmbH.











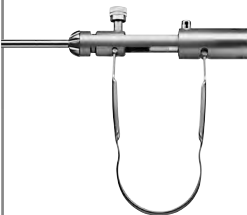

# HF CONNECTION CABLE MONO 8106xxx

| Instrument connector   | Device connector  |                                   | Product no.     |
|--|---|-----------------------------------|-----------------|
| <b>WOLF Instruments/surgical generator</b><br> |    | HF connection cable<br>mono L 3 m | <b>8106.032</b> |
|  | Erbe (ACC/ICC/VIO)/BOWA (EU)<br>R. Wolf HF surgical generator 400 kHz<br>2260002  | HF connection cable<br>mono L 5 m | <b>8106.052</b> |
|  |    | HF connection cable<br>mono L 3 m | <b>8106.132</b> |
|  | Erbe (T series)   | HF connection cable<br>mono L 5 m | <b>8106.152</b> |
| <b>HF electrodes, monopolar</b><br>           |    | HF connection cable<br>mono L 3 m | <b>8106.031</b> |
|  | Martin (M-version)/Berchold/<br>Aesculap  | HF connection cable<br>mono L 5 m | <b>8106.051</b> |
|  |    | HF connection cable<br>mono L 3 m | <b>8106.033</b> |
|  | Bovie/Valleylab/Erbe (Int.)/<br>BOWA (Int.)<br>R. Wolf HF surgical generator 400 kHz<br>2260001                             | HF connection cable<br>mono L 5 m | <b>8106.053</b> |
|  |    | HF connection cable<br>mono L 3 m | <b>8106.034</b> |
|  | BOWA (Int./EU)<br>Eschmann and other devices with<br>4 mm plugs<br>R. Wolf HF surgical generator 400 kHz<br>2260001/2260002 | HF connection cable<br>mono L 5 m | <b>8106.054</b> |





# BIPO HF CONNECTION CABLE

8108xxx

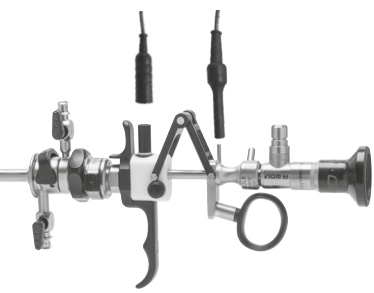

| Instrument connector  | Device connector   |  | Product no.                        |                 |
|---|--|--|------------------------------------|-----------------|
| <p><b>WOLF Bipolar forceps</b></p>                   |  <p>ERBE (ACC/ICC/T)/BOWA (EU)<br/>R. Wolf HF surgical generator 400 kHz<br/>2260001/2260002</p>      | HF connection cable<br>bipo; L 3 m   | <b>8108.032</b>                    |                 |
|   |  | HF connection cable<br>bipo; L 5 m   | <b>8108.052</b>                    |                 |
|   |  <p>International / 2-pin Valleylab<br/>R. Wolf HF surgical generator 400 kHz<br/>2260001/2260002</p> | HF connection cable<br>bipo; L 3 m   | <b>8108.033</b>                    |                 |
|   |  | HF connection cable<br>bipo; L 5 m   | <b>8108.053</b>                    |                 |
|   |  <p>WOLF/Martin (M-version)/<br/>Berchtold/Aesculap</p>  | HF connection cable<br>bipo; L 3 m   | <b>8108.031</b>                    |                 |
|   |  | HF connection cable<br>bipo; L 5 m   | <b>8108.051</b>                    |                 |
|   |  <p>EMC Dolley</p>  | HF connection cable<br>bipo; L 3 m   | <b>8108035</b>                     |                 |
|   | <p><b>Bipolar tweezers connection</b></p>   |  <p>ERBE (ACC/ICC/T)/BOWA (EU)<br/>R. Wolf HF surgical generator 400 kHz<br/>2260001/2260002</p>      | HF connection cable<br>bipo; L 3 m | <b>8108.132</b> |
|   |  |  | HF connection cable<br>bipo; L 5 m | <b>8108.152</b> |
|   |  |  <p>International / 2-pin Valleylab<br/>R. Wolf HF surgical generator 400 kHz<br/>2260001/2260002</p> | HF connection cable<br>bipo; L 3 m | <b>8108.133</b> |
| HF connection cable<br>bipo; L 5 m  |  |  | <b>8108.153</b>                    |                 |
|  <p>Martin (M-version)/Berchtold/<br/>Aesculap</p> |  | HF connection cable<br>bipo; L 3 m   | <b>8108.131</b>                    |                 |
|   |  | HF connection cable<br>bipo; L 5 m   | <b>8108.151</b>                    |                 |
|  <p>EMC Dolley</p>                                 |  | HF connection cable<br>bipo; L 3 m   | <b>8108135</b>                     |                 |

III23 || Subject to modifications. Please note that some products may not be available in all countries. Please always take note of the information that is provided with the product. For more detailed information, please consult with your contact partner or directly with Richard Wolf GmbH.

## HF CONNECTION CABLE BIPO FOR RESECTION IN SALINE SOLUTION

| Instrument connector  | Device connector   |  | Product no.             |
|---|--|--|-------------------------|
| <p><b>WOLF S(a)line resectoscopes</b></p>  | <br>Erbe VIO 300D   | <p><b>Bipolar cable; TUR/TCR; WOLF</b></p> <p>MF plug; L 4 m</p> | <p><b>20196-119</b></p> |
|   | <br>Erbe VIO 3  | <p><b>BIPOLAR CABLE; MF-U</b></p> <p>MF plug; L 4.5 m</p>        | <p><b>21196-119</b></p> |
|   | <br>KLS Martin  | <p><b>HF connection cable bipo; L 3 m</b></p>                    | <p><b>8108.231</b></p>  |
|   |  | <p><b>HF connection cable bipo; L 5 m</b></p>                    | <p><b>8108.251</b></p>  |
|   | <br>R. Wolf HF surgical generator 400 kHz 2260001/2260002 |  | <p><b>8108233</b></p>   |
|   |  | <p><b>HF connection cable bipo; L 5 m</b></p>                    | <p><b>8108253</b></p>   |

# MONO HF NEUTRAL ELECTRODE CABLE

| Instrument connector   | Device connector   |  | Product no.           |
|--|--|--|-----------------------|
| <p><b>2-pole neutral electrode</b></p>  |  <p>R. Wolf HF surgical generator 400 kHz<br/>2260001/2260002</p> | <p><b>Mono HF neutral electrode cable, L 4.5 m</b></p> | <p><b>2260031</b></p> |

III23 || Subject to modifications. Please note that some products may not be available in all countries. Please always take note of the information that is provided with the product. For more detailed information, please consult with your contact partner or directly with Richard Wolf GmbH.

# FLEXIBLE FIBER CHOLEDOCHOSCOPE 5 MM CHANNEL 2.5 MM

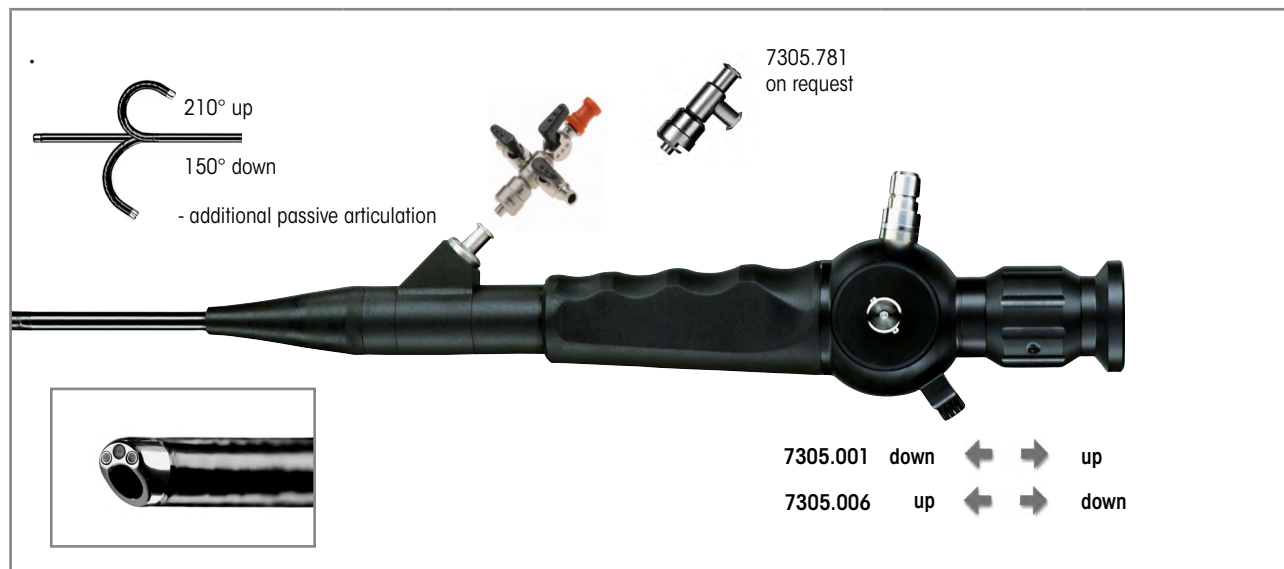

|   | Outer Ø       | Working channel | WL     | Control lever in distal direction – articulation downward | Control lever in distal direction – articulation upward | Product no.      |
|---|---------------|-----------------|--------|---|---|------------------|
| <b>Fiber cystoscope 15 FR WL 400 mm</b><br>Slanted distal tip<br>Articulation +210°/-150°<br>Direction of view 0°, viewing angle 110°   | 5 mm<br>15 Fr | 25 mm<br>75 Fr  | 400 mm | •   |   | <b>7305.001</b>  |
|   |               |                 |        |   | •   | <b>7305.006</b>  |
| <b>Fiber cystoscope bndl</b><br>consisting of:<br>Fiber cystoscope 15 FR WL 400 mm (7305.001)<br>Adapter with 2 irrigation valves and 1 instrument port (7305.782)<br>Leakage tester for flex. endoscopes (163.903)<br>Pressure equalization valve (163.904)<br>Cleaning brush Ø 3 mm, TL 1,200 mm (PACK= 10 PCS) (7990002) |               |                 |        | •   |   | <b>730500111</b> |
| <b>Fiber cystoscope bndl</b><br>consisting of:<br>Fiber cystoscope 15 FR WL 400 mm (7305.006)<br>Adapter with 2 irrigation valves and 1 instrument port (7305.782)<br>Leakage tester for flex. endoscopes (163.903)<br>Pressure equalization valve (163.904)<br>Cleaning brush Ø 3 mm, TL 1,200 mm (PACK= 10 PCS) (7990002) |               |                 |        |   | •   | <b>730500611</b> |

| Recommended accessories  | Product no.                                 |
|--|---|
| <b>Fiber light cable bndl</b> consisting of:<br>Fiber light cable Ø 2.5 mm TL 2.3 m (80662523),<br>projector-side adapter (8095.07), and endoscope-side adapter (809509) | Ø 2.5 mm,<br>2.3 m long<br><b>806625231</b> |

11123 | Subject to modifications. Please note that some products may not be available in all countries. Please always take note of the information that is provided with the product. For more detailed information, please consult with your contact partner or directly with Richard Wolf GmbH.

**mamba**  
VISION

**FLEXIBLE SENSOR ENDOSCOPE FOR USE IN CHOLEDOCHOSCOPY**

FOR ENDOCAM **Logic 4K** CONTROLLER



|  | Outer Ø | Working channel  | WL     | Control lever in distal direction – articulation downward | Control lever in distal direction – articulation upward | Product no.        |
|--|---------|------------------|--------|---|---|--------------------|
| <b>Sensor cystoscope</b><br><b>16.2 Fr WL 400 mm</b><br>Slanted distal tip<br>Articulation +210°/-210°<br>Direction of view 0°, viewing angle 120°   | 16.2 Fr | 2.5 mm<br>7.5 Fr | 400 mm | •   |   | <b>7315001</b>     |
|  |         |                  |        |   | •   | <b>7315006</b>     |
| <b>Sensor cystoscope bndl</b><br>consisting of:<br>Sensor cystoscope 16.2 FR, WL 400 mm (7315001)<br>Leakage tester for flex. endoscopes (163.903),<br>pressure equalization valve (163.904),<br>Luer sealing cap (15023205), and<br>cleaning brush Ø 5 mm, TL 1,200 mm (PACK= 10 PCS) (7990005) |         |                  |        | •   |   | <b>73150012</b>    |
| <b>Sensor cystoscope bndl</b><br>consisting of:<br>Sensor cystoscope 16.2 FR, WL 400 mm (7315006)<br>Leakage tester for flex. endoscopes (163.903),<br>pressure equalization valve (163.904),<br>Luer sealing cap (15023205), and<br>cleaning brush Ø 5 mm, TL 1200 mm (PACK= 10 PCS) (7990005)  |         |                  |        |   | •   | <b>73150062</b>    |
| <b>Recommended accessories</b>   |         |                  |        |   |   | <b>Product no.</b> |
| <b>Fiber light cable bndl</b> consisting of:<br>Fiber light cable Ø 2.5 mm TL 2.3 m (80662523), projector-side adapter (8095.07), and endoscope-side adapter (809509)  |         |                  |        | Ø 2.5 mm, 2.3 m long                                      |   | <b>806625231</b>   |

III23 || Subject to modifications. Please note that some products may not be available in all countries. Please always take note of the information that is provided with the product. For more detailed information, please consult with your contact partner or directly with Richard Wolf GmbH.

## TÜBINGER MIC TRAINING DEVICE

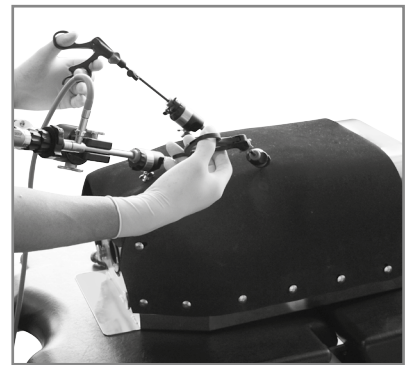
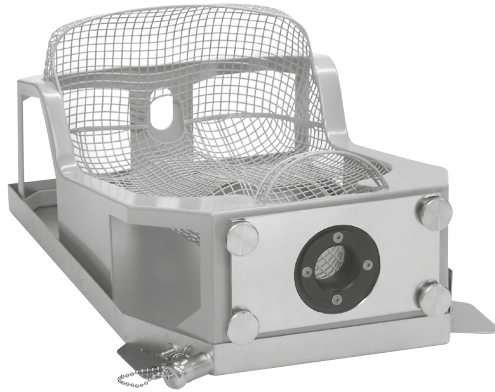

|   |                                | Product no.     |
|---|--------------------------------|-----------------|
| <b>Tübinger MIC trainer</b><br>with 3 abdominal walls (foam rubber) | (W x H x D) 560 x 350 x 230 mm | <b>9500.056</b> |

| Recommended accessories                         |   | Product no.      |
|---|---|------------------|
| <b>Abdominal wall, foam rubber, PACK= 5 PCS</b> |   | <b>9500.0561</b> |
| Available on request with transportation case   |  |                  |





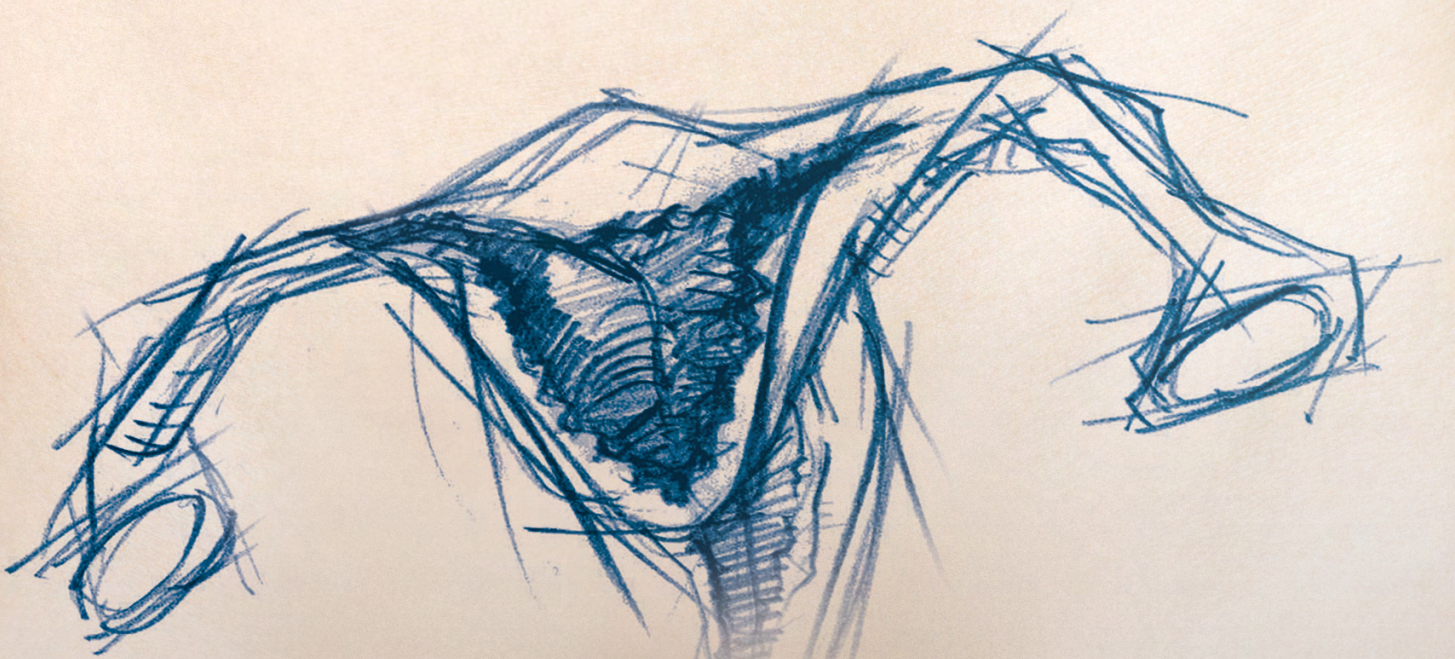

## HYSTERECTOMY

# HYSTERECTOMY

1

---

Secu**FIX** UTERUS MANIPULATOR



---

# SecuFIX UTERUS MANIPULATOR

## SYSTEM WITH COLPOTRANSILLUMINATION AND VACUUM FIXATION



|  |   | Product no. |
|--|---|-------------|
| SecuFIX Uterus manipulator Ø 36 mm           |   | 8370701     |
| SecuFIX Uterus probe Ø 5 mm                  | with longitudinal scale   | 8370702     |
| Cleaning brush Ø 5 mm, TL 515 mm             |   | 605         |
| Cleaning brush Ø 9 mm, TL 405 mm             |   | 609         |
| Sealing cap capacity 3.4–5.1 mm              | (PACK = 10 PCS)   | 8902        |
| Colpotransilluminator vacuum tube<br>SecuFIX | Set contains:<br>Colpotransilluminator and vacuum tube (with check valve, suction connection, Y connection part for use with a suction instrument on the same suction device, suction clamp), disposable<br>(PACK= 10 PCS, in individual sterile packaging) | 41708370    |

| Accessories   |  | Product no. |
|---|--|-------------|
| Irrigation tube L 0.6 m  |  | 163915      |
| Fiber light cable bndl   | Fiber bundle, Ø 3.5 mm (color marking orange), length 2.3 m  | 806635231   |
| RIWO System Tray         | Container (W x H x D) 500 x 60 x 200 mm with instrument mat<br>Internal dimensions (W x H x D): 500 x 57 x 200 mm,<br>External dimensions (W x H x D): 566 x 77 x 266 mm | 33024       |

1123|| Subject to modifications. Please note that some products may not be available in all countries. Please always take note of the information that is provided with the product. For more detailed information, please consult with your contact partner or directly with Richard Wolf GmbH.



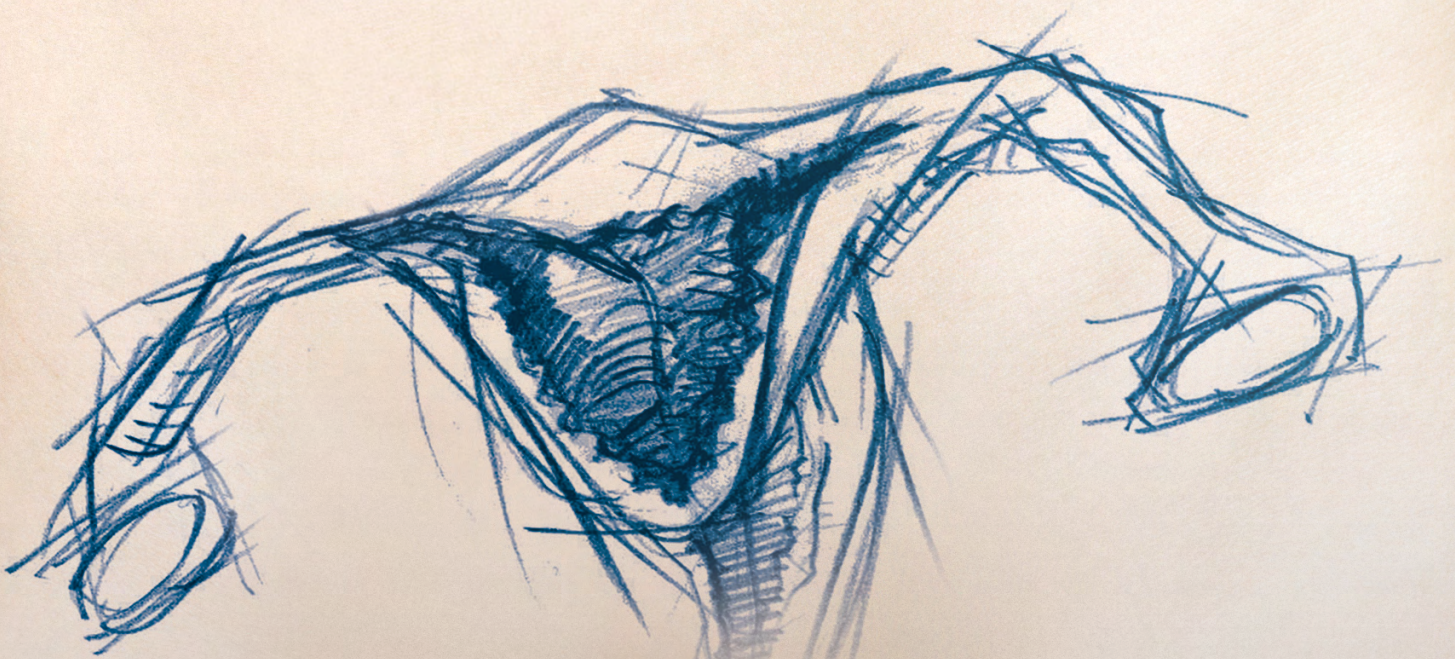

**DIAGNOSTIC AND  
SURGICAL HYSTEROSCOPY**

## DIAGNOSTIC AND SURGICAL HYSTEROSCOPY

1

BASIC SETS

2

TELESCOPES

3

HYSTEROSCOPE SHEATHS FOR 2.5 MM/4.0 MM TELESCOPES

4

HYSTEROSCOPE Ø 3.9 MM, 30°/HYSTEROSCOPE Ø 5 MM, 20°

5

FORCEPS/SCISSORS/SMALL MODULAR SYSTEM **HySafe**

6

ELECTRODES, BIPOLAR, MONOPOLAR

7

INSTRUMENTS FOR PORTIO AND UTERUS

8

HYSTEROscopic RESECTION

9

FLEXIBLE HYSTEROSCOPE

10

DEVICES/ACCESSORIES

## BASIC SET FOR DIAGNOSTIC HYSTEROSCOPY

| Product                                 | Product no.      | Quantity | Catalog/Section           |
|---|------------------|----------|---------------------------|
| without working channel                 |                  |          |                           |
| <b>Telescope 30° Ø 2.7 mm SL 310 mm</b> | <b>8974.402</b>  | 1        | Gynecology / hysteroscopy |
| <b>Sheath for hysteroscope 10.5 FR</b>  | <b>8985.11</b>   | 1        |                           |
| <b>Biopsy forceps bndl</b>              | <b>8642.6312</b> | 1        |                           |
| <b>Grasping forceps bndl</b>            | <b>8642.6502</b> | 1        |                           |
| alternative:                            |                  |          |                           |
| <b>Hysteroscope bndl</b>                | <b>89864021</b>  | 1        | Gynecology / hysteroscopy |

**BASIC SET HYSTERO-RESECTOSCOPE**
**PRINCESS™ E-LINE & S(A)LINE SYSTEM,**
**TELESCOPE 2.7 MM, 12°, 21 FR, PASSIVE, CONTINUOUS IRRIGATION**

| Product  | Product no. | Quantity | Catalog/Section           |
|--|-------------|----------|---------------------------|
| Outer sheath for resectoscope 21 FR  | 8653.021    | 1        | Gynecology / hysteroscopy |
| Inner sheath for resectoscope 19 FR  | 8653.018    | 1        |                           |
| Obturator for resectoscope 19 FR   | 8653.18     | 1        |                           |
| Passive, mono/bipo working element<br>with open handle, passive cutting          | 8653.224    | 1        |                           |
| Telescope 12° Ø 2.7 mm SL 310 mm   | 8974.412    | 1        |                           |
| Cutting electrode bipo 21 FR   | 46531313    | 1        |                           |
| Roller electrode bipo 21/24.5 FR   | 4653.023    | 1        |                           |
| Hook electrode mono/bipo 21/24.5 FR  | 865303      | 1        |                           |
| Protective sterilization sleeve<br>for connection to max. 5 electrodes, reusable | 8428.901    | 1        |                           |
| Bipolar HF cable   | 8108....    | 1        |                           |
| FLUID CONTROL 2225<br>Irrigation pump for HYS/URO/LAP bndl                       | 22250011    | 1        |                           |
| Balancing module   | 2225023     | 1        |                           |



## MINI FIBER TELESCOPE 2.0 MM

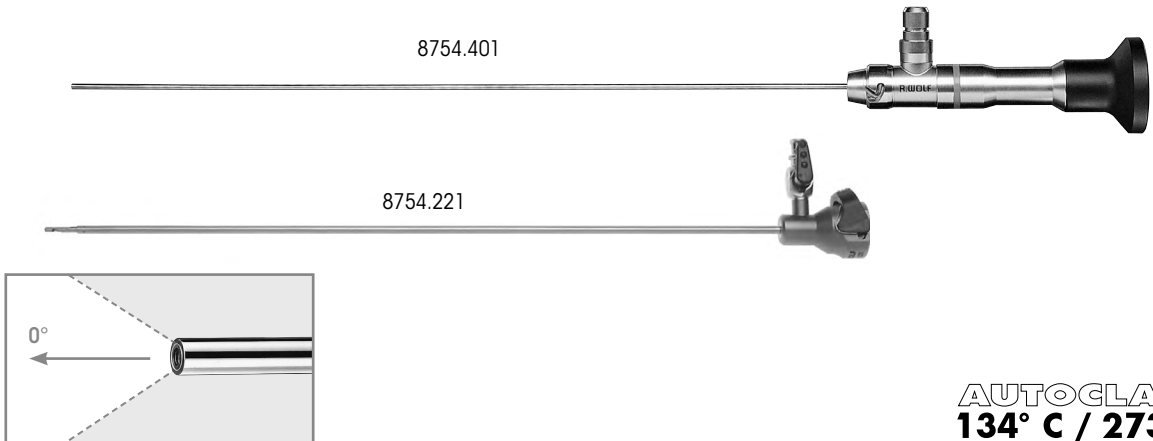

|   | Direction of view | WL     | TL     | Ø      | Product no.    |
|---|-------------------|--------|--------|--------|----------------|
| <b>Telescope 0° Ø 2 mm NL 268 mm</b>  | 0°                | 268 mm | 365 mm | 2.0 mm | <b>8754401</b> |
| <b>also:</b>  |                   |        |        |        |                |
| <b>VERES cannula Ø 2.3 mm WL 250 mm</b><br>consisting of:<br>1x VERES cannula Ø 2.3 mm WL 274 mm (8754.211)<br>1x outer sheath Ø 2.8 mm, WL 250 mm (8754.221) |                   | 250 mm |        | 2.3 mm | <b>8754201</b> |

| Recommended accessories   |                              | Product no.      |
|---|------------------------------|------------------|
| <b>Perforated basket for standard telescope 2</b><br>(for telescope 8754.401)   | (L x W x H) 481 x 59 x 54 mm | <b>38016</b>     |
| <b>Fiber light cable bndl</b><br>consisting of:<br>Fiber light cable (80662523), projector-side adapter (8095.07),<br>and endoscope-side adapter (809509) | Ø 2.5 mm, 2.3 m long         | <b>806625231</b> |

## MINI SURGICAL HYSTEROSCOPE



|   | Direction of view | W x H        | WL     | TL     | Product no.     |
|---|-------------------|--------------|--------|--------|-----------------|
| Telescope 12° W 3.6 mm H 2 mm WL 227 mm with lateral eyepiece | 12°               | 3.6 x 2.0 mm | 227 mm | 358 mm | <b>8753.411</b> |

**also:**

|                                       | Color coding | WL     | Outer Ø          | Working channel | Product no.     |
|---------------------------------------|--------------|--------|------------------|-----------------|-----------------|
| Outer sheath for hysteroscope 15 FR   | yellow       | 214 mm | 3.8 mm           | 3 Fr            | <b>8753.001</b> |
| Inner sheath for hysteroscope         |              | -      | 1.5 mm           |                 | <b>8753.002</b> |
| Outer sheath for hysteroscope 15 FR   | blue         | 214 mm | 4.8 mm           | 5 Fr            | <b>8753.003</b> |
| Inner sheath for hysteroscope         |              | -      | 2.2 mm x 3.42 mm |                 | <b>8753.004</b> |
| Outer sheath for hysteroscope 15.5 FR | green        | 214 mm | 5.4 mm           | 7 Fr            | <b>8753.006</b> |
| Inner sheath for hysteroscope         |              | -      | 2.8 mm x 2.98 mm |                 | <b>8753.007</b> |
| Outer sheath for hysteroscope 17.5 FR | white        | 214 mm | 5.8 mm           | 9 Fr            | <b>8753.008</b> |
| Inner sheath for hysteroscope         |              | -      | 3.5 mm x 4.04 mm |                 | <b>8753.009</b> |

| Recommended accessories  | Product no.   |
|--|---|
| Rigid grasping forceps Ø 3 mm WL 346 mm                   | <b>8993.235</b>   |
| Perforated basket for hysteroscope 1 for holding replacement sheaths, with small parts basket  | Internal dimens. (W x H x D): 51 x 65 x 124 mm<br>External dimens. (W x H x D): 467 x 75 x 132 mm<br><b>38006</b> |
| Fiber light cable bndl consisting of:<br>Fiber light cable (80662523), projector-side adapter (8095.07), and endoscope-side adapter (809509) | Ø 2.5 mm, 2.3 m long<br><b>806625231</b>  |

# HYSTEROSCOPE TELESCOPES

## Ø 2.7 MM/Ø 4.0 MM

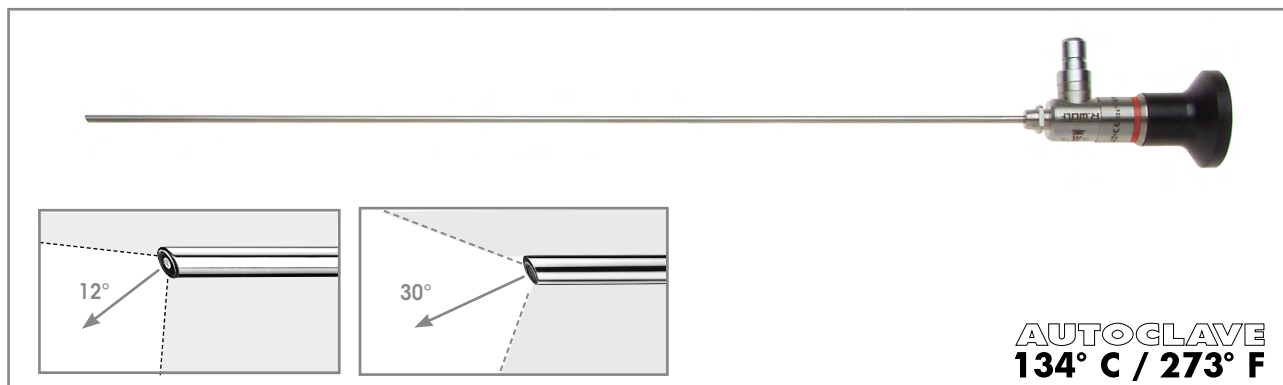

|                                  | Direction of view | Ø      | SL     | TL     | Product no. |
|----------------------------------|-------------------|--------|--------|--------|-------------|
| Telescope 12° Ø 2.7 mm SL 310 mm | 12°               | 2.7 mm | 310 mm | 373 mm | 8974.412    |
| Telescope 30° Ø 2.7 mm SL 310 mm | 30°               | 2.7 mm | 310 mm | 370 mm | 8974.402    |

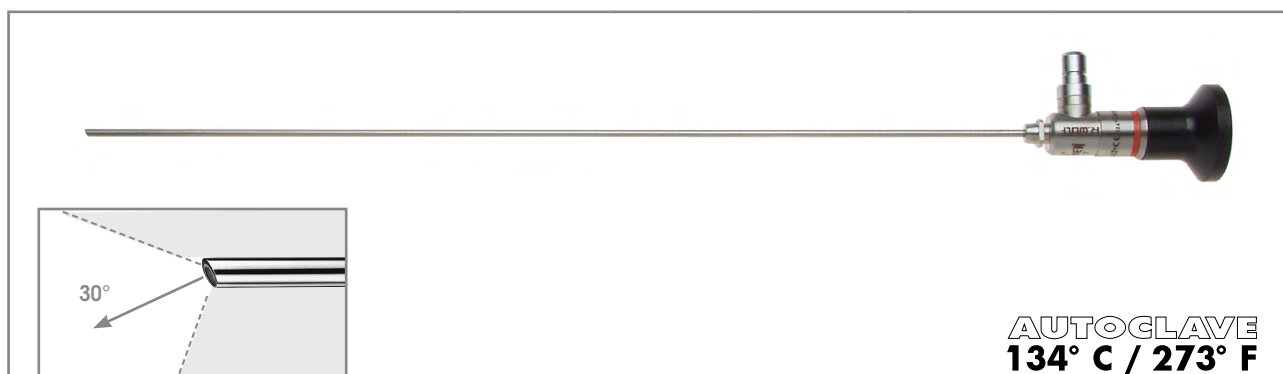

|                                | Direction of view | Ø      | SL     | TL     | Product no. |
|--------------------------------|-------------------|--------|--------|--------|-------------|
| Telescope 30° Ø 4 mm SL 299 mm | 30°               | 4.0 mm | 299 mm | 372 mm | 8989.412    |



| Recommended accessories  |  | Product no. |
|--|--|-------------|
| Perforated basket for standard telescope 2   | Dimensions (L x W x H): 481 x 59 x 54 mm | 38016       |
| Fiber light cable bndl consisting of:<br>Fiber light cable (80662523), projector-side adapter (8095.07), and endoscope-side adapter (809509) | Ø 2.5 mm, 2.3 m long                     | 806625231   |

1123 || Subject to modifications. Please note that some products may not be available in all countries. Please always take note of the information that is provided with the product. For more detailed information, please consult with your contact partner or directly with Richard Wolf GmbH.

# DIAGNOSTIC HYSTEROSCOPE SHEATH

10.5 FR /Ø 3.5 MM



FOR TELESCOPE 2.7 MM, 30°

|   |  |                      |        |        |                 |                 |
|---|--|----------------------|--------|--------|-----------------|-----------------|
|   |  | Sheath               | WL     |        | Product no.     |                 |
|    |  | 10.5 Fr/<br>Ø 3.5 mm | 255 mm |        | <b>8985.11</b>  |                 |
| <b>Sheath for hysteroscope 10.5 FR round</b>  |  |                      |        |        |                 |                 |
|  |  |                      |        |        | <b>8986.251</b> |                 |
| <b>Handle for hysteroscope</b>  |  |                      |        |        |                 |                 |
| <b>also:</b>  |  |                      |        |        |                 |                 |
|   |  | Direction of view    | Ø      | SL     | TL              | Product no.     |
| <b>Telescope 30° Ø 2.7 mm SL 310 mm</b>   |  | 30°                  | 2.7 mm | 310 mm | 370 mm          | <b>8974.402</b> |

| Recommended accessories   |  | Product no.      |
|---|--|------------------|
| <b>Perforated basket for standard telescope 2</b>   | Dimensions (L x W x H): 481 x 59 x 54 mm | <b>38016</b>     |
| <b>Fiber light cable bndl</b><br>consisting of:<br>Fiber light cable (80662523), projector-side adapter (8095.07),<br>and endoscope-side adapter (809509) | Ø 2.5 mm, 2.3 m long                     | <b>806625231</b> |

# DIAGNOSTIC HYSTEROSCOPE SHEATH 12 FR, OVAL

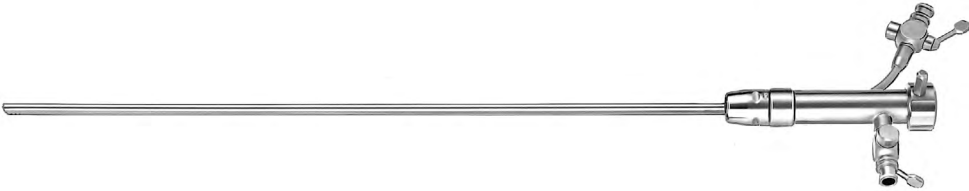
FOR TELESCOPE 2.7 MM, 30°

|  |   |                        |           |                    |                    |
|--|---|------------------------|-----------|--------------------|--------------------|
|  |   |                        |           |                    |                    |
|  | <b>Sheath</b>   | <b>Working channel</b> | <b>WL</b> | <b>Product no.</b> |                    |
|   | 12 Fr   | 3 Fr                   | 246 mm    | <b>8974.121</b>    |                    |
| <b>Sheath for hysteroscope 12 FR oval</b>  |   |                        |           |                    |                    |
|  |  |                        |           | <b>8986.251</b>    |                    |
| <b>Handle for hysteroscope</b>   |   |                        |           |                    |                    |
| <b>also:</b>   |   |                        |           |                    |                    |
|  | <b>Direction of view</b>  | <b>Ø</b>               | <b>SL</b> | <b>TL</b>          | <b>Product no.</b> |
| <b>Telescope 30° Ø 2.7 mm SL 310 mm</b>  | 30°   | 2.7 mm                 | 310 mm    | 370 mm             | <b>8974.402</b>    |

| <b>Recommended accessories</b>  | <b>Product no.</b>                                       |
|---|--|
| <b>Perforated basket for standard telescope 2</b>   | Dimensions (L x W x H): 481 x 59 x 54 mm<br><b>38016</b> |
| <b>Fiber light cable bndl</b><br>consisting of:<br>Fiber light cable (80662523), projector-side adapter (8095.07),<br>and endoscope-side adapter (809509) | Ø 2.5 mm, 2.3 m long<br><b>806625231</b>                 |

1123|| Subject to modifications. Please note that some products may not be available in all countries. Please always take note of the information that is provided with the product. For more detailed information, please consult with your contact partner or directly with Richard Wolf GmbH.

**OptiFLOW™**



**HIGHFLOW CONTINUOUS IRRIGATION SURGICAL SHEATH**

**5.5 MM**

FOR TELESCOPE 2.7 MM, 12° AND 30°

SHEATHS

3

|    |   |                 |        |                 |                 |
|--|---|-----------------|--------|-----------------|-----------------|
|  | Sheath  | Working channel | WL     | Product no.     |                 |
| <br><b>Sheath for hysteroscope 16.5 FR</b><br>distal sheath end, oval | 12 Fr   | 5 Fr            | 219 mm | <b>8974351</b>  |                 |
| <b>Handle for hysteroscope</b>   |  |                 |        | <b>8986.251</b> |                 |
| <b>also:</b>   |   |                 |        |                 |                 |
|  | Direction of view   | Ø               | SL     | TL              | Product no.     |
| <b>Telescope 12° Ø 2.7 mm SL 310 mm</b>  | 12°   | 2.7 mm          | 310 mm | 373 mm          | <b>8974.412</b> |
| <b>Telescope 30° Ø 2.7 mm SL 310 mm</b>  | 30°   | 2.7 mm          | 310 mm | 370 mm          | <b>8974.402</b> |



| Recommended accessories   | Product no.  |
|---|--|
| <b>Perforated basket for standard telescope 2</b>   | Dimensions (L x W x H): 481 x 59 x 54 mm<br><b>38016</b> |
| <b>Fiber light cable bndl</b><br>consisting of:<br>Fiber light cable (80662523), projector-side adapter (8095.07),<br>and endoscope-side adapter (809509) | Ø 2.5 mm, 2.3 m long<br><b>806625231</b>                 |

||23|| Subject to modifications. Please note that some products may not be available in all countries. Please always take note of the information that is provided with the product. For more detailed information, please consult with your contact partner or directly with Richard Wolf GmbH.

# DIAGNOSTIC HYSTEROSCOPE SHEATH

## 15 FR

### FOR TELESCOPE 4 MM, 30°



|  |   |                 |        |                 |                 |
|--|---|-----------------|--------|-----------------|-----------------|
|  | Sheath  | Working channel | WL     | Product no.     |                 |
|   | 12 Fr   | 3 Fr            | 255 mm | <b>8989.151</b> |                 |
| <b>Sheath for hysteroscope 15 FR</b><br>distal sheath end, oval                    |   |                 |        |                 |                 |
|  |  |                 |        | <b>8986.251</b> |                 |
| <b>Handle for hysteroscope</b>   |   |                 |        |                 |                 |
| <b>also:</b>   |   |                 |        |                 |                 |
|  | Direction of view   | Ø               | SL     | TL              | Product no.     |
| <b>Telescope 30° Ø 4 mm SL 299 mm</b>  | 30°   | 4.0 mm          | 299 mm | 372 mm          | <b>8989.412</b> |

| Recommended accessories   |  | Product no.      |
|---|--|------------------|
| <b>Perforated basket for standard telescope 2</b>   | Dimensions (L x W x H): 481 x 59 x 54 mm | <b>38016</b>     |
| <b>Fiber light cable bndl</b><br>consisting of:<br>Fiber light cable (80662523), projector-side adapter (8095.07),<br>and endoscope-side adapter (809509) | Ø 2.5 mm, 2.3 m long                     | <b>806625231</b> |

# SURGICAL CONTINUOUS IRRIGATION HYSTEROSCOPE SHEATH

## 15 FR OVAL

FOR TELESCOPE 4 MM, 30°

|  |   |                 |        |                 |                 |
|--|---|-----------------|--------|-----------------|-----------------|
|  | Sheath  | Working channel | WL     | Product no.     |                 |
|   | 15 Fr   | 3 Fr            | 230 mm | <b>8989.031</b> |                 |
| <b>Sheath for hysteroscope 15 FR</b><br>distal sheath end, oval                    |   |                 |        |                 |                 |
|  |  |                 |        | <b>8986.251</b> |                 |
| <b>Handle for hysteroscope</b>   |   |                 |        |                 |                 |
| <b>also:</b>   |   |                 |        |                 |                 |
|  | Direction of view   | Ø               | SL     | TL              | Product no.     |
| <b>Telescope 30° Ø 4 mm SL 299 mm</b>  | 30°   | 4.0 mm          | 299 mm | 372 mm          | <b>8989.412</b> |

| Recommended accessories   | Product no.  |
|---|--|
| <b>Perforated basket for standard telescope 2</b>   | Dimensions (L x W x H): 481 x 59 x 54 mm<br><b>38016</b> |
| <b>Fiber light cable bndl</b><br>consisting of:<br>Fiber light cable (80662523), projector-side adapter (8095.07),<br>and endoscope-side adapter (809509) | Ø 2.5 mm, 2.3 m long<br><b>806625231</b>                 |







1123 | Subject to modifications. Please note that some products may not be available in all countries. Please always take note of the information that is provided with the product. For more detailed information, please consult with your contact partner or directly with Richard Wolf GmbH.



# SURGICAL CONTINUOUS IRRIGATION HYSTEROSCOPE SHEATH

## 21 FR

### FOR TELESCOPE 4 MM, 30°

| byGallinat   |   |  |                 |        |                  |
|--|---|--|-----------------|--------|------------------|
| 8988.031   |   |  |                 |        |                  |
| 8988.231   |   |  |                 |        |                  |
| 8988.241   |   |  |                 |        |                  |
|  |   | Sheath                                   | Working channel | WL     | Product no.      |
|    | with oblique distal end, rotatable drain stopcock, and quick release lock | 21 Fr                                    | -               | 204 mm | <b>8988.031</b>  |
| also:  |   |  |                 |        |                  |
|   | specifically for 8988.031   |  |                 |        | <b>8988.131</b>  |
|   | with deflection lever and supply stopcock                                 |  | 7 Fr            |        | <b>8988.231</b>  |
|   | with ramp and supply stopcock   |  | 7 Fr            |        | <b>8988.241</b>  |
| also:  |   |  |                 |        |                  |
|  | Direction of view   | Ø  | SL              | TL     | Product no.      |
| Telescope 30° Ø 4 mm SL 299 mm   | 30°   | 4.0 mm                                   | 299 mm          | 372 mm | <b>8989.412</b>  |
| Recommended accessories  |   |  |                 |        | Product no.      |
| Perforated basket for standard telescope 2   |   | Dimensions (L x W x H): 481 x 59 x 54 mm |                 |        | <b>38016</b>     |
| Fiber light cable bndl consisting of:<br>Fiber light cable (80662523), projector-side adapter (8095.07), and endoscope-side adapter (809509) |   | Ø 2.5 mm, 2.3 m long                     |                 |        | <b>806625231</b> |



1123|| Subject to modifications. Please note that some products may not be available in all countries. Please always take note of the information that is provided with the product. For more detailed information, please consult with your contact partner or directly with Richard Wolf GmbH.

# HYSTEROSCOPE

## 3.9 MM, 30°

HYSTEROSCOPE

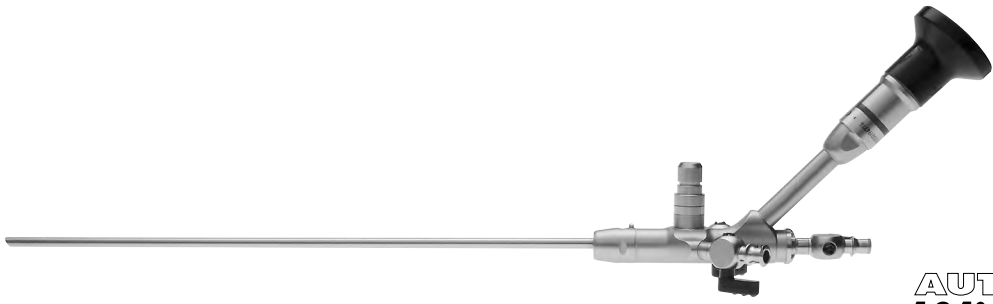
4



|  <p><b>AUTOCLAVE</b><br/><b>134° C / 273° F</b></p>  |   |                 |        |                 |
|--|---|-----------------|--------|-----------------|
|  | Sheath  | Working channel | WL     | Product no.     |
|  <p><b>Hysteroscope bndl</b><br/>consisting of:<br/>Hysteroscope 30° Ø 3.9 mm WL 217 mm<br/>(8986402) and rubber cap capacity 0.8 mm<br/>(PACK = 10 PCS, 88.01)</p> | Ø 3.9 mm  | 5 Fr            | 217 mm | <b>89864021</b> |
| <p><b>Handle for hysteroscope</b></p>  |  |                 |        | <b>8986.251</b> |

| Recommended accessories   |   | Product no.      |
|---|---|------------------|
| <p><b>Perforated basket for hysteroscope 2</b><br/>with small part basket</p>   | <p>Internal dimensions (W x H x D): 451 x 80 x 124 mm,<br/>External dimensions (W x H x D): 467 x 90 x 132 mm</p> | <b>38009</b>     |
| <p><b>Fiber light cable bndl</b><br/>consisting of:<br/>Fiber light cable (80662523), projector-side adapter (8095.07),<br/>and endoscope-side adapter (809509)</p> | Ø 2.5 mm, 2.3 m long  | <b>806625231</b> |

1123 | Subject to modifications. Please note that some products may not be available in all countries. Please always take note of the information that is provided with the product. For more detailed information, please consult with your contact partner or directly with Richard Wolf GmbH.

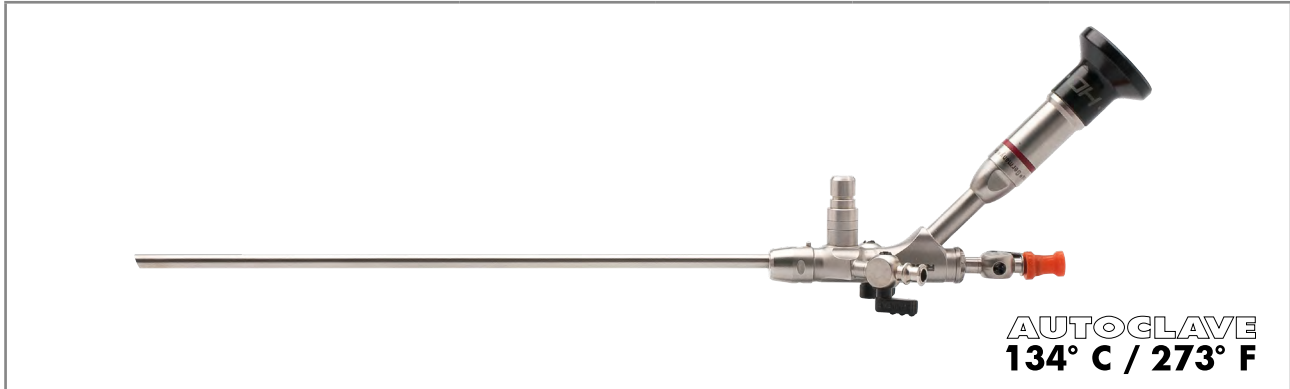
# HYSTEROSCOPE 5 MM, 20°





|   | Sheath  | Working channel | WL     | Product no.     |
|---|---|-----------------|--------|-----------------|
| <br><b>Hysteroscope 20° Ø 5 mm WL 217 mm with lateral eyepiece</b> | Ø 5 mm  | 5 Fr            | 217 mm | <b>8986.401</b> |
| <b>Handle for hysteroscope</b>  |  |                 |        | <b>8986.251</b> |

| Recommended accessories   |   | Product no.      |
|---|---|------------------|
| <b>Perforated basket for hysteroscope 2</b><br>with small part basket   | Internal dimensions (W x H x D): 451 x 80 x 124 mm,<br>External dimensions (W x H x D): 467 x 90 x 132 mm | <b>38009</b>     |
| <b>Fiber light cable bndl</b><br>consisting of:<br>Fiber light cable (80662523), projector-side adapter (8095.07),<br>and endoscope-side adapter (809509) | Ø 2.5 mm, 2.3 m long  | <b>806625231</b> |

1123 || Subject to modifications. Please note that some products may not be available in all countries. Please always take note of the information that is provided with the product. For more detailed information, please consult with your contact partner or directly with Richard Wolf GmbH.

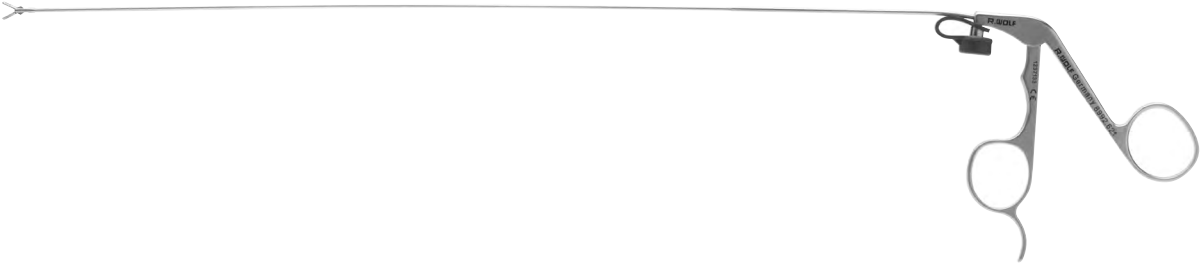





## RIGID PREPARATION FORCEPS 7 FR

|    |      |        |        |                 |
|--|------|--------|--------|-----------------|
| with irrigation connector  | Fr   | WL     | TL     | Product no.     |
|  <p><b>Rigid preparation forceps 7 FR WL 371 mm</b><br/>with internal and external toothings</p> | 7 Fr | 371 mm | 460 mm | <b>8992.621</b> |

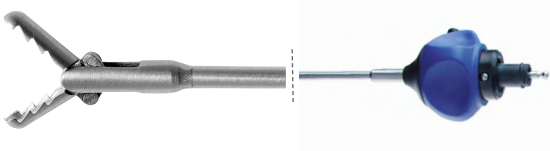
# FORCEPS AND SCISSORS

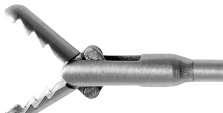
## SMALL MODULAR SYSTEM **HySafe**



360° ROTATABLE, CAN BE FLUSHED THROUGH, EASY CLICK

| Grasping forceps jaw insert with sheath   |             |    |        | Handle with overload protection  | Complete instrument   |
|---|-------------|----|--------|--|---|
|    |             |    |        |  | <ul style="list-style-type: none"> <li>Jaw section</li> <li>Handle</li> </ul> |
|   | Product no. | Fr | WL     | 8083.001   | Product no.   |
|   | 8642.6508   | 5  | 340 mm | •  | <b>8642.6502</b>  |
|  | 8992.6308   | 7  | 310 mm | •  | <b>8992.6302</b>  |
|  | 8642.6008   | 5  | 340 mm | •  | <b>8642.6002</b>  |
|  | 8642.6818   | 5  | 340 mm | •  | <b>8642.6812</b>  |
|  | 8642.6318   | 5  | 340 mm | •  | <b>8642.6312</b>  |
|  | 8992.6408   | 7  | 310 mm | •  | <b>8992.6402</b>  |

## MONOPOLAR ELECTRODE 5/6 FR





MONOPOLAR



|   | Fr   | WL     | Product no.   |
|---|------|--------|---------------|
| <br><b>Coagulation electrode mono 6 FR WL 400 mm</b> | 6 Fr | 400 mm | <b>823.06</b> |
| <br><b>Needle electrode mono 5 FR WL 420 mm</b>    | 5 Fr | 420 mm | <b>824.05</b> |

HF connection cable: see page GYN44/45

## FOR PORTIO AND UTERUS

|  | WL     | TL     | Product no.    |
|--|--------|--------|----------------|
|    |        |        |                |
| <br><b>Uterus grasping forceps WL 92 mm,</b><br>by Pozzi<br>with distally overlapping tips  | 92 mm  | 254 mm | <b>8370.25</b> |
| <br><b>Uterus grasping forceps WL 100 mm,</b><br>by Gimpelson<br>with four spherical teeth | 100 mm | 242 mm | <b>8371.10</b> |
| <br><b>Uterus grasping forceps Ø 6.5 mm WL 100 mm,</b><br>by Saarges                      | 100 mm | 262 mm | <b>8370.00</b> |

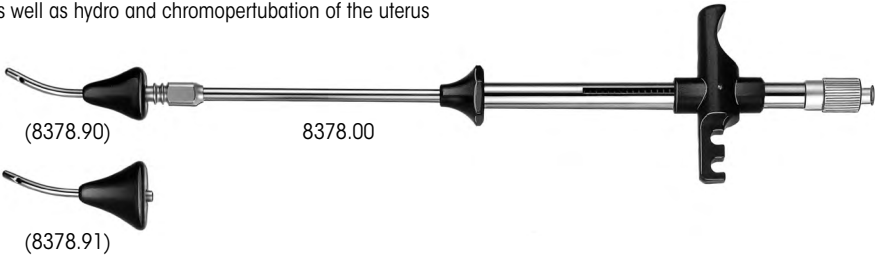









| for fixation, elevation, as well as hydro and chromopertubation of the uterus  |       |        |                 |
|--|-------|--------|-----------------|
|  <p>(8378.90)                      8378.00</p> <p>(8378.91)</p>  |       |        |                 |
|  | WL    | TL     | Product no.     |
| <b>Intrauterine probes bndl</b><br>consisting of:<br>Intrauterine probe Ø 32 mm WL 32 mm,<br>by Cohen (8378.00),<br>conical portio adapter size small (8378.90),<br>conical portio adapter size large (8378.91),<br>tube with Luer-Lock connector (886.00) | 32 mm | 330 mm | <b>8378001*</b> |

\*also: Uterus grasping forceps WL 92 mm, by Pozzi (8370.25)

**PRINCESS**  
**PETIT RESECTOSCOPE INCLUDING**  
**E-LINE & S(A)LINE SYSTEM**



**AUTOCLAVE**  
**134° C / 273° F**

| Size,<br>Color coding             | distal end  | Outersheath for resectoscope 21 FR  | Inner sheath for resectoscope 19 FR   | Passive, mono/bipo working element with open handle                                 |   | Telescope 12°<br>Ø 2.7 mm<br>SL 310 mm  | Obturators  |   |
|-----------------------------------|---|---|---|---|---|---|---|---|
|                                   |   |   |   | passive cutting   | active cutting  |   | Viewing obturator for resectoscope 19 FR  | Obturator for resectoscope 19 FR  |
| Sheaths                           |    |  |  |  |  |  |  |  |
| <b>7 mm</b><br>21 Fr<br>black     |  | <b>8653.021</b>   | <b>8653.018</b>   | <b>8653.224</b>   | <b>8653204</b>  | <b>8974.412</b>   | <b>865319</b>   | <b>8653.18</b>  |
| also:                             |   |   |   |   |   |   |   |   |
| <b>Electrodes:</b> see page GYN26 |   |  |   |   |   |   |   |   |









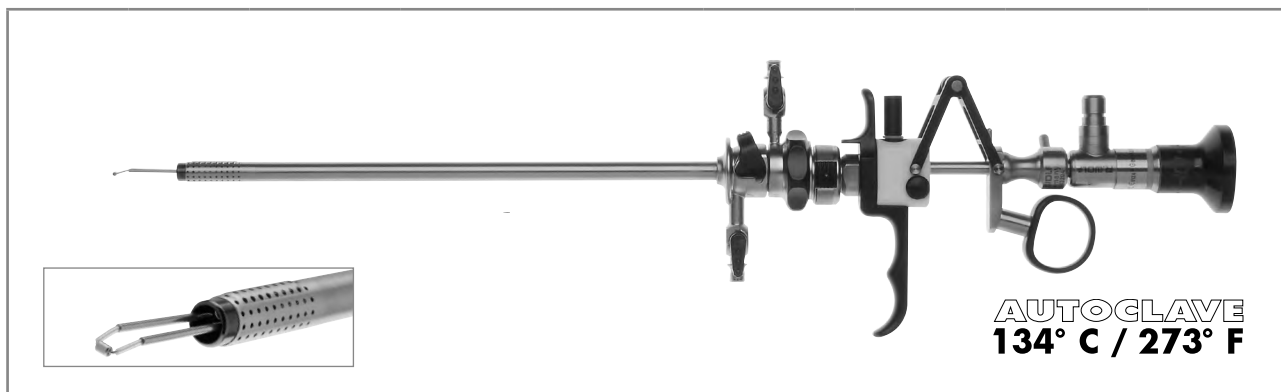

| Recommended accessories   | Product no.  |
|---|--|
| <b>Working insert for resectoscope</b><br>for auxiliary instruments up to 7 Fr  | <br><b>8653284</b>                   |
| <b>HF bipolar connection cable L 3 m</b>  | for KLS-Martin generators, M-version<br><b>8108.231</b>  |
|   | for Erbe generators<br><b>8108.232</b>   |
| <b>Container (W x H x D) 400 X 60 X 200 mm</b>  | Internal dimensions (W x H x D): 400 x 57 x 200 mm<br>External dimensions (W x H x D): 466 x 77 x 266 mm<br><b>33022</b> |
| <b>Fiber light cable bndl</b><br>consisting of:<br>Fiber light cable (80662523), projector-side adapter (809.507),<br>and endoscope-side adapter (809509) | Ø 2.5 mm, 2.3 m long<br><b>806625231</b>   |

|| Subject to modifications. Please note that some products may not be available in all countries. Please always take note of the information that is provided with the product. For more detailed information, please consult with your contact partner or directly with Richard Wolf GmbH.



**PRINCESS**  
**PETIT RESECTOSCOPE INCLUDING**  
**E-LINE & S(A)LINE SYSTEM, ROTATABLE**







| Size,<br>Color coding  | distal end  | Outersheath for resectoscope 21 Fr  | Inner sheath for resectoscope 19 Fr   | Working element with open handle  |   | Telescope 12°<br>Ø 2.7 mm<br>SL 310 mm  | Obturators  |   |
|--|---|---|---|---|---|---|---|---|
|  |   |   |   | passive cutting   | active cutting  |   | Viewing obturator for resectoscope 19 Fr  | Obturator for resectoscope 19 Fr  |
| Sheaths  |   |  |  |  |  |  |  |  |
| <b>7 mm</b><br>21 Fr<br>black  |  | <b>8653022</b>  | <b>8653019</b>  | <b>8653.224</b>   | <b>8653204</b>  | <b>8974.412</b>   | <b>865319</b>   | <b>8653.18</b>  |
| <b>8 mm</b><br>24.5 Fr<br>green  |  | <b>8655.334</b>   | <b>8655.344</b>   |   |   |   |   |   |
| also:  |   |   |   |   |   |   |   |   |
| <b>Electrodes:</b> see page GYN 26  |   |   |   |   |   |   |   |   |

| Recommended accessories   | Product no.  |                  |
|---|--|------------------|
| <b>Working insert for resectoscope</b><br>for auxiliary instruments up to 7 Fr  | <b>8653284</b>   |                  |
| <b>HF bipolar connection cable L 3 m</b>  | for KLS-Martin generators, M-version   | <b>8108.231</b>  |
|   | for Erbe generators  | <b>8108.232</b>  |
| <b>Container (W x H x D) 400 X 60 X 200 mm</b>  | Internal dimensions (W x H x D): 400 x 57 x 200 mm<br>External dimensions (W x H x D): 466 x 77 x 266 mm | <b>33022</b>     |
| <b>Fiber light cable bndl</b><br>consisting of:<br>Fiber light cable (80662523), projector-side adapter (809.507),<br>and endoscope-side adapter (809509)           | Ø 2.5 mm, 2.3 m long   | <b>806625231</b> |

# ELECTRODES

FOR PRINCESS RESECTOSCOPE,  
TELESCOPE 2.7 MM, 12°

## 12°, for multiple use, monopolar/bipolar

|   | Designation                         | Bracket                | for sheath sizes [in Fr] |         | Color coding |      | Product no. |
|---|-------------------------------------|------------------------|--------------------------|---------|--------------|------|-------------|
|   |                                     |                        | CI 21                    | CI 24.5 | Fork         | Stem |             |
|  | Cutting electrode mono 21 FR        | Loop round<br>Ø 0.3 mm | •                        | –       | red          | blue | 8653.131    |
|  | Cutting electrode mono 24.5 FR      | Loop round<br>Ø 0.3 mm | –                        | •       | blue         | blue | 8653.132    |
|  | Roller electrode mono 21/24.5 FR    | Roll                   | •                        | •       | red          | blue | 8653.02     |
|  | Hook electrode mono/bipo 21/24.5 FR | Hook                   | •                        | •       | red          | blue | 865303      |

• suitable for corresponding sheath size – not suitable CI = continuous irrigation

## 12°, disposable, sterile\* bipolar

| (PACK = 3 PCS)  | Designation                      | Bracket                | for sheath sizes [in Fr] |         | Color coding |      | Product no. |
|---|----------------------------------|------------------------|--------------------------|---------|--------------|------|-------------|
|   |                                  |                        | CI 21                    | CI 24.5 | Fork         | Stem |             |
|  | Cutting electrode bipo 21 FR     | Loop round<br>Ø 0.3 mm | •                        | –       | transparent  | blue | 46531313    |
|  | Cutting electrode bipo 24.5 FR   | Loop round<br>Ø 0.3 mm | –                        | •       | transparent  | blue | 4653.1323   |
|  | Roller electrode bipo 21/24.5 FR | Roll                   | •                        | •       | transparent  | blue | 4653.023    |
|  | BIVAP electrode bipo 21 FR       | Torus                  | •                        | –       | blue         | blue | 46530213    |
|   | BIVAP electrode bipo 24.5 FR     | Torus                  | –                        | •       | blue         | blue | 46530243    |
|  | Hook electrode 21/24.5 FR        | Hook                   | •                        | •       | blue         | blue | 4653033     |

• suitable for corresponding sheath size – not suitable \* in individual sterile packaging CI = continuous irrigation

### Recommended accessories





|  | Product no.     |
|--|-----------------|
| <b>Protective sterilization sleeve</b><br>for connection to max. 5 electrodes, reusable  | <b>8428.901</b> |

1123 | Subject to modifications. Please note that some products may not be available in all countries. Please always take note of the information that is provided with the product. For more detailed information, please consult with your contact partner or directly with Richard Wolf GmbH.

# RESECTION MASTER WITH AUTOMATIC CHIP SUCTION



**AUTOGLAVE**  
**134° C / 273° F**

| Size,<br>Color coding         | distal end  | Outersheath<br>for resectoscope 27 FR  | Working element<br>passive mono/bipo  | Telescope 30°<br>Ø 3.3 mm<br>SL 299 mm   | Obturator for<br>resectoscope  |
|-------------------------------|---|--|---|--|--|
|                               |   |  | passive cutting   |  |  |
|                               |   |  |  |  |  |
| <b>9 mm</b><br>27 Fr<br>black |  | <b>8659.071</b>  | <b>8659.2351</b>  | <b>8656.422</b>  | <b>8659.175</b>  |



| Recommended accessories   |  | Product no.      |
|---|--|------------------|
| <b>Tube set RESECTION PUMP 2228</b><br>disposable   | PVC, (PACK = 10 PCS) in individual sterile packaging   | <b>4170.2228</b> |
| <b>Container (W x H x D) 400 X 60 X 200 mm</b>  | Internal dimensions (W x H x D): 400 x 57 x 200 mm<br>External dimensions (W x H x D): 466 x 77 x 266 mm | <b>33022</b>     |
| <b>Fiber light cable bndl</b><br>consisting of:<br>Fiber light cable (80662523), projector-side adapter (809.507),<br>and endoscope-side adapter (809509) | Ø 2.5 mm, 2.3 m long   | <b>806625231</b> |

1123 || Subject to modifications. Please note that some products may not be available in all countries. Please always take note of the information that is provided with the product. For more detailed information, please consult with your contact partner or directly with Richard Wolf GmbH.

# ELECTRODES



## FOR RESECTION MASTER WITH AUTOMATIC CHIP SUCTION

### 30°, for multiple use, monopolar/bipolar

|   | Designation                    | Bracket                 | for sheath sizes [in Fr] |    | Color coding |      | Product no. |
|---|--------------------------------|-------------------------|--------------------------|----|--------------|------|-------------|
|   |                                |                         | CI                       | 27 | Fork         | Stem |             |
|  | Cutting electrode mono 27 FR   | Loop round<br>Ø 0.25 mm | •                        |    | red          | red  | 8659.161    |
|  | Vapo electrode mono 27 FR      | Loop cylindrical        | •                        |    | blue         | blue | 8659.162    |
|  | Hook electrode mono/bipo 27 FR | Hook                    | •                        |    | red          | red  | 8659.163    |

**CI** = continuous irrigation

### 30°, disposable, sterile\*, bipolar

| (PACK = 3 PCS)  | Designation                  | Bracket                 | for sheath sizes [in Fr] |    | Color coding |      | Product no. |
|---|------------------------------|-------------------------|--------------------------|----|--------------|------|-------------|
|   |                              |                         | CI                       | 27 | Fork         | Stem |             |
|  | Cutting electrode bipo 27 FR | Loop round<br>Ø 0.25 mm | •                        |    | blue         | blue | 4659.1613   |
|  | Roller electrode bipo 27 FR  | Loop Roll<br>Ø 0.3 mm   | •                        |    | blue         | blue | 4659.1623   |

\* in individual sterile packaging **CI** = continuous irrigation

#### Recommended accessories

|  | Product no.     |
|--|-----------------|
| <b>Protective sterilization sleeve</b><br>for connection to max. 5 electrodes, reusable  | <b>8428.901</b> |

1123 | Subject to modifications. Please note that some products may not be available in all countries. Please always take note of the information that is provided with the product. For more detailed information, please consult with your contact partner or directly with Richard Wolf GmbH.

## RESECTION PUMP 2228

MICROPROCESSOR-CONTROLLED HIGH-PERFORMANCE CHIP SUCTION PUMP  
WITH CLEAR LCD DISPLAY



|  |  | Product no. |
|--|--|-------------|
| RESECTION PUMP 2228<br>Suction pump  |  | 2228.001    |
| <b>also:</b>   |  |             |
| <b>Tube set RESECTION PUMP 2228</b><br>(PACK = 10 PCS.) packed singly, sterile | consisting of:<br>Control tube with filter, irrigation tube with non-return valve,<br>chip aspiration tube with non-return valve and pump tube | 4170.2228   |
| <b>Bottle holder cpl.</b>  |  | 64030.125   |
| <b>Bottle mount</b>  |  | 64031.381   |
| <b>Overflow protection / bacteria filter</b><br>for single use (PACK = 10 PCS) |  | 2228.901    |
| <b>Chip collecting container</b><br>250 ml for tissue chips                    |  | 2228.801    |
| <b>Tube insert</b><br>for collecting container 250 ml                          |  | 2228.802    |
| <b>Secretion container 2L</b><br>autoclavable                                  |  | 8170.6551   |
| <b>Cover</b> for secretion container 2L  |  | 8170.6552   |
| <b>Sound absorber</b> (PACK = 3 PCS)   |  | 35100.115   |
| <b>Connection tube recto pump</b>  |  | 8170.6554   |
| <b>Power cable</b>   | cable length 3 m   | 2440.03     |

# TECHNICAL DATA

## RESECTION PUMP 2228







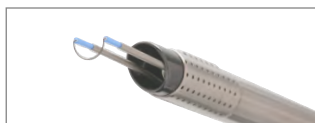

| RESECTION PUMP 2228  |   | 2228.001 |
|--|---|----------|
| <b>Device properties</b>   |   |          |
| Operating conditions   | +10°C to +40°C, 30% to 75% rel. humidity, atmospheric pressure 800 hPa to 1,060 hPa                 |          |
| Storage and transport conditions   | - 20°C to +60°C , 10% to 90% rel. humidity, atmospheric pressure 700 hPa to 1,060 hPa               |          |
| <b>Power supply</b>  |   |          |
| Mains + frequency  | 100–240 V~, 50/60 Hz  |          |
| Power consumption  | 120 VA  |          |
| Current rating   | 1.2–0.5   |          |
| Fuse   | T 1.6 AL 250 V  |          |
| <b>Regulatory standards</b>  |   |          |
| Protection class to EN/IEC 60601-1<br>(UL 2601-1/CSA C22.2 No.601.1 – for USA) | I   |          |
| Electromagnetic compatibility (EMC)  | EN/IEC 60601-1-2  |          |
| Medical Devices Directive 93/42/EEC  | Class II a  |          |
| Degree of protection against the ingress of liquids                            | IP 20 (not protected)   |          |
| Noise level  | 55 dB (A) (pump "ON" with container)  |          |
| Operating mode   | Continuous operation  |          |
| Protection against electric shock  | Type BF applied part  |          |
| Degree of protection in the presence of flammable mixtures                     | Device is not protected against explosions<br>(do not operate this device in explosive atmospheres) |          |
| <b>Dimensions and weights</b>  |   |          |
| Weight, bndl with accessories  | 8.9 kg (19.6 lbs)   |          |
| Dimensions (W x H x D)   | 340 mm x 105 mm x 420 mm  |          |
| Space requirements with bottle holder (W x H x D)                              | 470 mm x 410 mm x 430 mm  |          |
| <b>Relevant application parameters</b>   |   |          |
| Vacuum<br>Operation vacuum<br>Maximum vacuum                                   | 650 to 750 mbar +/- 50 mbar<br>750 mbar +/- 50 mbar   |          |
| Suction pulse<br>Level 1 (low)<br>Level 2 (medium)<br>Level 3 (high)           | 3.8 ml +/- 0.5 ml<br>6.2 ml +/- 0.7 ml<br>9.2 ml +/- 1.0 ml   |          |

**Shark** BIPOLAR RESECTOSCOPE  
 FOR TELESCOPE 4 MM, 30°, 12  
 WITH CONTINUOUS IRRIGATION DOUBLE SHEATH SYSTEM FOR RESECTION IN SALINE SOLUTION

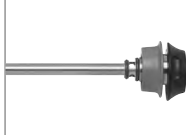
Working element, inner sheath, and telescope rotate in outer sheath



**AUTOCLAVE**  
**134° C / 273° F**

| Size,<br>Color coding | distal end  | Outersheath<br>for resectoscope 24 FR  | Inner sheath<br>for resectoscope 22 FR   | Telescope 30°<br>Ø 4 mm<br>NL 300 mm  | Telescope 12°<br>Ø 4 mm<br>WL 297 mm   | Obturator   |   |
|-----------------------|---|--|--|---|--|---|---|
|                       |   |  |  |   |  | Obturator for<br>resectoscope<br>22 FR  | Viewing<br>obturator<br>for resecto-<br>scope 22 FR                                   |
| Sheaths               |    |  |  |  |  |  |  |
| 22/24 Fr<br>green     |  | <b>8675424</b>   | <b>8675322</b>   | <b>8654.422</b>   | <b>8654.431</b>  | <b>8673022</b>  | <b>8673122</b>  |

also:

**Working elements:** see page GYN32

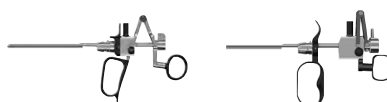





**Electrodes:** see page GYN33

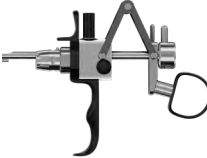

| Recommended accessories   | Product no.  |
|---|--|
| <b>HF bipolar connection cable</b>  | See page GYN54/55  |
| <b>Perforated basket for standard telescope 2</b>   | Internal dimensions (W x H x D): 454 x 52 x 40 mm<br>External dimensions (W x H x D): 481 x 54 x 59 mm<br><b>38016</b> |
| <b>Fiber light cable bndl</b><br>consisting of:<br>Fiber light cable (80662523), projector-side adapter (8095.07),<br>and endoscope-side adapter (809509) | Ø 2.5 mm, 2.3 m long<br><b>806625231</b>   |

## WORKING ELEMENTS

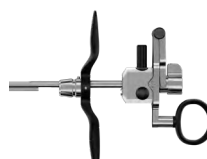
FOR  BIPOLAR RESECTOSCOPES  
TELESCOPE 4 MM, 30°, 12°



|  |   | Handle variants | cutting        | Product no.     |
|--|---|-----------------|----------------|-----------------|
| <b>Active working element</b><br><b>bipo 0/12/30°</b><br><br>Cut is made against spring pressure |    | open            | <b>active</b>  | <b>8680.204</b> |
| <b>Active working element</b><br><b>bipo 0/12/30°</b><br><br>Cut is made against spring pressure |    | closed          |                | <b>8680.205</b> |
| <b>Passive working element</b><br><b>bipo 0/12/30°</b><br><br>Cut is made with spring pressure   |   | open            | <b>passive</b> | <b>8680.224</b> |
| <b>Passive working element</b><br><b>bipo 0/12/30°</b><br><br>Cut is made with spring pressure   |  | closed          |                | <b>8680.225</b> |

| Recommended accessories                                   |   | Product no.      |
|---|---|------------------|
| <b>Rubber cap, black</b><br><b>(PACK = 5 PCS)</b>         | for sealing off the electrode clamping mechanism on the working element | <b>8880</b>      |
| <b>Thumb ring</b><br>with relatively large inner diameter |   | <b>15008.159</b> |





# ELECTRODES

FOR  BIPOLAR RESECTOSCOPES  
TELESCOPE 4 MM, 30°, 12°

| 12°/30°, for multiple use, bipolar  |  |                           |                          |       |              |        |         |
|---|--|---------------------------|--------------------------|-------|--------------|--------|---------|
|   | Designation                                | Bracket                   | for sheath sizes [in Fr] |       | Color coding |        | Model   |
|   |  |                           | CI                       | 22/24 | Fork         | Stem   |         |
|  | Cutting electrode<br>bipo 22 FR<br>12/30°  | Loop<br>round<br>Ø 0.3 mm | •                        |       | blue         | yellow | 8622133 |
|  | Coag. electrode<br>bipo 22-26 FR<br>12/30° | Cylinder<br>Ø 1.2 mm      | •                        |       | blue         | yellow | 8623022 |
|  | Hook electrode<br>bipo 22-26 FR<br>12/30°  | Hook                      | •                        |       | blue         | yellow | 862309  |

- suitable for corresponding sheath size **CI** = continuous irrigation

| 12°/30°, disposable, sterile*, bipolar  |  |                            |                          |       |              |      |           |
|---|--|----------------------------|--------------------------|-------|--------------|------|-----------|
| (PACK =<br>3 PCS)   | Designation                            | Bracket                    | for sheath sizes [in Fr] |       | Color coding |      | Model     |
|   |  |                            | CI                       | 22/24 | Fork         | Stem |           |
|  | Cutting electrode mono<br>22 FR 12/30° | Loop<br>round<br>Ø 0.25 mm | •                        |       | blue         | blue | 4622.2533 |
|  | Cutting electrode<br>bipo 22 FR 12/30° | Loop<br>round<br>Ø 0.3 mm  | •                        |       | blue         | blue | 4622.1333 |
|  | Coag. electrode<br>bipo 22 FR 12/30°   | Cylinder<br>Ø 1.2 mm       | •                        |       | blue         | blue | 4623.0243 |
|  | BIVAP electrode<br>bipo 22 FR 12/30°   | Torus                      | •                        |       | blue         | blue | 46300223  |

- suitable for corresponding sheath size \* in individual sterile packaging **CI** = continuous irrigation







| Recommended accessories  | Product no.     |
|--|-----------------|
| <b>Protective sterilization sleeve</b><br>for connection to max. 5 electrodes, reusable  | <b>8428.901</b> |

**Shark** MONOPOLAR RESECTOSCOPE  
FOR TELESCOPE 4 MM, 30°, 12°  
WITH CONTINUOUS IRRIGATION DOUBLE SHEATH SYSTEM

Working element, inner sheath, and telescope rotate in outer sheath



**AUTOCLAVE**  
**134° C / 273° F**

| Size,<br>Color coding | distal end  | Outersheath<br>for resectoscope 24 FR  | Inner sheath<br>for resectoscope 22 FR  | Telescope 30°<br>Ø 4 mm<br>NL 300 mm   | Telescope 12°<br>Ø 4 mm<br>WL 297 mm  | Obturator   |   |
|-----------------------|---|--|---|--|---|---|---|
|                       |   |  |   |  |   | Obturator for<br>resectoscope<br>22 FR  | Viewing<br>obturator<br>for resecto-<br>scope 22 FR                                   |
| Sheaths               |  |  |  |  |  |  |  |
| 22/24 Fr<br>green     |   | <b>8675424</b>   | <b>8675322</b>  | <b>8654.422</b>  | <b>8654.431</b>   | <b>8673022</b>  | <b>8673122</b>  |

also:

**Working elements:** see page GYN35

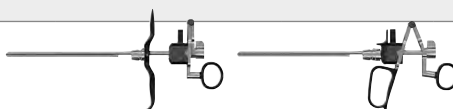

**Electrodes:** see page GYN36/37







| Recommended accessories   | Product no.  |
|---|--|
| <b>HF monopolar connection cable</b>  | <b>See page GYN44/45</b>   |
| <b>Perforated basket for standard telescope 2</b>   | Internal dimensions (W x H x D): 454 x 52 x 40 mm<br>External dimensions (W x H x D): 481 x 54 x 59 mm<br><b>38016</b> |
| <b>Fiber light cable bndl</b><br>consisting of:<br>Fiber light cable (80662523), projector-side adapter (809.507),<br>and endoscope-side adapter (809509) | Ø 2.5 mm, 2.3 m long<br><b>806625231</b>   |

1123 Subject to modifications. Please note that some products may not be available in all countries. Please always take note of the information that is provided with the product. For more detailed information, please consult with your contact partner or directly with Richard Wolf GmbH.

## WORKING ELEMENTS

FOR  MONOPOLAR RESECTOSCOPES  
TELESCOPE 4 MM, 30°, 12°







|   |   | Handle variants                   | cutting | Product no.    |
|---|---|-----------------------------------|---------|----------------|
| <p><b>Active working element mono 12/30°</b></p> <p>Cut is made against spring pressure</p> |    | closed                            | active  | <b>8674205</b> |
| <p><b>Active working element mono 12/30°</b></p> <p>Cut is made against spring pressure</p> |    | closed<br>with comfort thumb rest |         | <b>8674234</b> |
| <p><b>Passive working element mono 12/30°</b></p> <p>Cut is made with spring pressure</p>   |   | open                              | passive | <b>8674224</b> |
| <p><b>Passive working element mono 12/30°</b></p> <p>Cut is made with spring pressure</p>   |  | closed                            |         | <b>8674225</b> |

| Recommended accessories   |   | Product no.      |
|---|---|------------------|
| <p><b>Rubber cap, red (PACK = 5 PCS)</b></p>                      | for sealing off the electrode clamping mechanism on the working element | <b>8874</b>      |
| <p><b>Thumb ring</b><br/>with relatively large inner diameter</p> |   | <b>15008.159</b> |

# ELECTRODES

FOR  MONOPOLAR RESECTOSCOPES  
TELESCOPE 4 MM, 30°, 12°

## 12°/30°, for multiple use, monopolar

|   | Designation                                | Bracket                            | for sheath sizes [in Fr] |       | Color coding |           | Model    |
|---|--|------------------------------------|--------------------------|-------|--------------|-----------|----------|
|   |  |                                    | CI                       | 22/24 | Fork         | Stem      |          |
|    | Cutting electrode<br>mono 22 FR<br>12/30°  | Loop<br>round<br>Ø 0.35 mm         |                          | •     | green        | dark gray | 86782235 |
|    | Coag. electrode<br>mono 22–24 FR<br>12/30° | Roll                               |                          | •     | green        | dark gray | 86782201 |
|    | Coag. electrode<br>mono 22–24 FR<br>12/30° | Sphere                             |                          | •     | green        | dark gray | 86782202 |
|    | Coag. electrode<br>mono 22–24 FR<br>12/30° | Button                             |                          | •     | green        | dark gray | 86782203 |
|  | Knife electrode<br>mono 22–24 FR<br>12/30° | Knife                              |                          | •     | green        | dark gray | 86782204 |
|  | Hook electrode<br>mono 22–24 FR<br>12/30°  | Hook                               |                          | •     | green        | dark gray | 86782205 |
|  | Wing electrode<br>mono 22 FR<br>12/30°     | Wing<br>(bracket profile,<br>flat) |                          | •     | green        | dark gray | 86782206 |

- suitable for corresponding sheath size **CI** = continuous irrigation

### Recommended accessories

**Protective sterilization sleeve**  
for connection to max. 5 electrodes, reusable



Product no.

**8428.901**

## DISPOSABLE ELECTRODES

FOR  MONOPOLAR RESECTOSCOPES  
TELESCOPE 4 MM, 30°, 12°

### 12°/30° disposable, sterile\*, monopolar

|   | Designation   | Bracket                 | for sheath sizes [in Fr] |       | Color coding |             | Model    |
|---|---|-------------------------|--------------------------|-------|--------------|-------------|----------|
|   |   |                         | CI                       | 22/24 | Fork         | Stem        |          |
|    | <b>Cutting electrode mono 22 FR 12/30°</b><br>(PACK = 10 PCS) | Loop round<br>Ø 0.35 mm |                          | •     | green        | transparent | 46782235 |
|   | <b>Cutting electrode mono 22 FR 12/30°</b><br>(PACK = 10 PCS) | Loop round<br>Ø 0.25 mm |                          | •     | green        | transparent | 46782225 |
|    | <b>Coag electrode mono 22-24 FR 12/30°</b><br>(PACK = 5 PCS)  | Roll                    |                          | •     | green        | transparent | 46782201 |
|    | <b>Coag electrode mono 22-24 FR 12/30°</b><br>(PACK = 5 PCS)  | Sphere                  |                          | •     | green        | transparent | 46782202 |
|  | <b>Coag electrode mono 22-24 FR 12/30°</b><br>(PACK = 5 PCS)  | Button                  |                          | •     | green        | transparent | 46782203 |
|  | <b>Knife electrode mono 22-24 FR 12/30°</b><br>(PACK = 5 PCS) | Knife                   |                          | •     | green        | transparent | 46782204 |
|  | <b>Hook electrode mono 24 FR 12/30°</b><br>(PACK = 5 PCS)     | Hook                    |                          | •     | green        | transparent | 46782205 |

- suitable for corresponding sheath size
- \* in individual sterile packaging
- CI** = continuous irrigation

# FLEXIBLE FIBER HYSTEROSCOPE

2.5 MM/7.5 FR

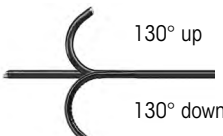



130° up  
130° down

7305.782  
included in scope of delivery



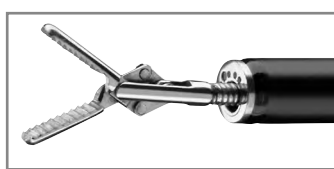



|  | Outer Ø   | Working channel  | WL     | TL     | Product no.     |
|--|---|------------------|--------|--------|-----------------|
| <b>Fiber Hysteroscope<br/>Ø 2.5 mm WL 200 mm</b><br>Slanted distal tip<br>articulation +130/-130° direction of<br>view 0°, angle of view 60° | 2.5 mm<br>7.5 Fr /Fr  | 1.2 mm<br>3.6 Fr | 200 mm | 450 mm | <b>7325.122</b> |
| on request   |   |                  |        |        |                 |
|   | <b>Flex. grasping forceps Ø 1 mm WL 600 mm,<br/>rippled</b> |                  | 600 mm | 736 mm | <b>7223.65</b>  |

| Recommended accessories  | Product no.   |
|--|---|
| <b>Sterilization basket for flexible endoscopes</b>  | (W x H x D): 448 x 288 x 106 mm<br><br><b>33016</b> |
| <b>Fiber light cable bndl</b> consisting of:<br>Fiber light cable Ø 1.6 mm TL 1.8 m (80661618), projector-side<br>adapter (809.507), and endoscope-side adapter (809509) | Ø 2.5 mm, 2.3 m long<br><br><b>806616181</b>        |

# FLUID CONTROL 2225

## SUCTION IRRIGATION PUMP

1123 || Subject to modifications. Please note that some products may not be available in all countries. Please always take note of the information that is provided with the product. For more detailed information, please consult with your contact partner or directly with Richard Wolf GmbH.



core

|  |  | Product no.     |
|--|--|-----------------|
| <b>FLUID CONTROL 2225</b><br><b>Irrigation pump for HYS/URO/LAP</b>      | Fluid management for flushing irrigation fluids into the uterus , as well as the upper and lower urinary tract, and for suction and irrigation in the abdomen  | <b>2225001</b>  |
| <b>FLUID CONTROL 2225</b><br><b>Irrigation pump for HYS/URO/LAP bndI</b> | consisting of:<br>Irrigation pump for HYS/URO/LAP (2225001)<br>Power cable (2440.03)   | <b>22250011</b> |
| <b>also:</b>   |  |                 |
| <b>Balancing module</b>  | for hysteroscopy and endourology, fluid management for fluid balancing in combination with FLUID CONTROL 2225, mobile stand with integrated weighing cells and space for up to 4 irrigation fluid bags | <b>2225023</b>  |

DEVICES / ACCESSORIES

10

# FLUID CONTROL 2225

## SUCTION IRRIGATION TUBE SETS

| Irrigation  |  |  | Product no.    |
|---|--|--|----------------|
| Accessories<br>– reusable   | Tube set with piercing spike                   | with Luer-Lock connection, autoclavable, incl. 10 spare membranes, reusable for 20 reprocessing cycles | <b>8171223</b> |
|   | Irrigation tube set with piercing spike, L 3 m | (PACK = 10 PCS), with Luer-Lock connection, sterile, disposable product                                | <b>4171223</b> |
| Accessories<br>– disposable   | Tube set with CARE-LOCK, L 3 m                 | (PACK = 10 PCS), sterile, disposable product   | <b>4171224</b> |
|   | Suction irrigation tube set                    | (PACK = 10 PCS), with piercing spike, sterile disposable product, PVC                                  | <b>4171225</b> |
|   | Day irrigation tube set                        | (PACK = 10 PCS), sterile, disposable product, PVC  | <b>4171226</b> |
|   | Patient irrigation tube set, sterile           | (PACK = 10 PCS), with Luer-Lock connection, sterile, disposable product, PVC                           | <b>4171227</b> |
| <i>Note: Day tube and patient tube can only be used together. A new patient tube is required for each patient – the day tube can be used for up to 20 patients.</i> |  |  |                |

| Suction                     |   |   | Product no.      |
|-----------------------------|---|---|------------------|
| Accessories<br>– reusable   | Tube set for vacuum, incl. filter       | with integrated hygiene filter, PACK = 10 PCS, service life: 30 days (connected to irrigation pump) | <b>2206207</b>   |
|                             | Irrigation tube                         | L 1.2 m, with Luer-Lock, for suction irrigation handle 8385901 and tube set 8171223 or 8170223      | <b>817123</b>    |
|                             | Suction tube L 3 m                      | for suction irrigation handle 8385901   | <b>8171402</b>   |
|                             | Secretion container, 2 l                | 2 liters, with lid  | <b>8170.655</b>  |
|                             | Secretion container, 2 l                | 2 liters, no lid  | <b>8170.6551</b> |
| Accessories<br>– disposable | Secretion container, 2.5 l              | 2.5 liters  | <b>41706566</b>  |
|                             | Secretion container bndl consisting of: | Secretion container 2.5 l (41706566) and secretion bag (PACK = 90 PCS) (41706564)                   | <b>4170657</b>   |
|                             | Tube set for suction (2 connections)    | sterile, disposable product, (PACK = 10 PCS) for connecting instruments to collecting container     | <b>T0503-01</b>  |
|                             | Angled 90° plug-in coupling             | (PACK = 10 PCS) For connecting vacuum tube 2206207 to disposable container systems                  | <b>0771019</b>   |



# FLUID CONTROL 2225

## CABLE ACCESSORIES

|                                    |                    | Product no.     |
|------------------------------------|--------------------|-----------------|
| Patch cable, RJ45 SFTP, 0.5 m      | Cable length 0.5 m | <b>72325378</b> |
| Patch cable, RJ45 HRS TM11, 1.0 m  | Cable length 1.0 m | <b>72325429</b> |
| Patch cable, RJ45 S/FTP CAT.6 10 m | Cable length 10 m  | <b>72325434</b> |
| Plastic caps for network socket    | (PACK = 8 PCS)     | <b>5592105</b>  |
| Power cable                        | Cable length 3 m   | <b>2440.03</b>  |

# TECHNICAL DATA

## FLUID CONTROL 2225

| FLUID CONTROL 2225   |             | 2225001   |
|--|-------------|---|
| <b>Device properties</b>                                   |             |   |
| Operating conditions                                       |             | +10°C to +40°C, 30% to 75% rel. humidity, 70 to 106 kPa atmospheric pressure<br>3,000 m max. altitude above sea level |
| Storage and transport conditions                           |             | -20°C to +60°C, 10% to 90% rel. humidity 70 to 106 kPa atmospheric pressure   |
| <b>Power supply</b>  |             |   |
| Mains + frequency  |             | 100–240 V~, 50/60 Hz  |
| Power consumption  | 100 V/60 Hz | 110 VA  |
|  | 240 V/50 Hz | 120 VA  |
| Current rating   | 100 V/60 Hz | 1.10 A  |
|  | 240 V/50 Hz | 0.50 A  |
| Fuse   |             | T 3.15 AH, 250 V  |
| <b>Regulatory standards</b>                                |             |   |
| Protection class (I, II)                                   |             | I   |
| Electromagnetic compatibility (EMC)                        |             | EN 60601-1/IEC 60601-1<br>EN 60601-1-2/IEC 60601-1-2  |
| Medical Devices Directive 93/42/EEC                        |             | Class IIb   |
| Housing protection rating (IP code)                        |             | IP21  |
| Protection against electric shock                          |             | Type BF applied part  |
| Degree of protection in the presence of flammable mixtures |             | Device is not protected against explosions<br>(do not operate this device in explosive atmospheres)                   |
| Maximum suction vacuum                                     |             | -60 kPa   |
| <b>Dimensions and weights</b>                              |             |   |
| Weight   |             | 8.8 kg  |
| Dimensions (W x H x D)                                     |             | 300 mm x 157 mm x 436 mm  |

| Relevant application parameters |  |
|---------------------------------|--|
| Nominal flow range              | Hysteroscopy: 800 ml/min (max. flow, not adjustable)<br>Endourology: 10–800 ml/min (max. flow)<br>Laparoscopy: 0.1–1.8 l/min (max. flow) |
| Suction power                   | max. 2 l/min   |
| Starting nominal pressure range | Hysteroscopy: 15–200 mmHg<br>Endourology: 15–90 mmHg/20–120 cmH2O<br>Laparoscopy: 300 mmHg (not adjustable)                              |
| Pressure                        | 0–300 mmHg   |
| Deficit                         | -9,990 to +9,990 ml/0 to 99.9 l  |

# TECHNICAL DATA

## FLUID CONTROL 2225

| <b>Balancing module</b>             |   | <b>2225023</b> |
|-------------------------------------|---|----------------|
| <b>Device properties</b>            |   |                |
| Operating conditions                | +10°C to +40°C, 30% to 75% rel. humidity, 70 to 106 kPa atmospheric pressure<br>3,000 m max. altitude above sea level |                |
| Storage and transport conditions    | - 20°C to + 60°C, 10% to 90% rel. humidity 70 to 106 kPa atmospheric pressure   |                |
| <b>Regulatory standards</b>         |   |                |
| Electromagnetic compatibility (EMC) | EN 60601-1/IEC 60601-1<br>EN 60601-1-2/IEC 60601-1-2  |                |
| Housing protection rating (IP code) | IP21  |                |
| Maximum load of container scale     | 16 kg/4 containers of 3 l each  |                |
| Maximum load of bag scale           | 23 kg/4 bags of 5 l each  |                |
| <b>Dimensions and weights</b>       |   |                |
| Weight                              | 15.4 kg   |                |
| Dimensions (W x H x D)              | 618 mm x 1,064 mm x 618 mm  |                |

# HF CONNECTION CABLE MONO 815xxx

DEVICES / ACCESSORIES

10

| Instrument connector   | Device connector   |                                   | Product no.    |
|--|--|-----------------------------------|----------------|
| <b>WOLF Resectoscopes</b><br>         |  <p>ERBE (ACC/ICC/IO)/BOWA (EU)<br/>R. Wolf HF surgical generator 400 kHz<br/>2260002</p>   | HF connection cable<br>mono L 3 m | <b>815.032</b> |
|  |  | HF connection cable<br>mono L 5 m | <b>815.052</b> |
|  |  <p>ERBE (T series)</p>   | HF connection cable<br>mono L 3 m | <b>815.132</b> |
|  |  | HF connection cable<br>mono L 5 m | <b>815.152</b> |
| <b>HF electrodes, monopolar</b><br> |  <p>Martin (M-version)/Berchtold/<br/>Aesculap</p>  | HF connection cable<br>mono L 3 m | <b>815.031</b> |
|  |  | HF connection cable<br>mono L 5 m | <b>815.051</b> |
|  |  <p>Bovie/Valleylab/Erbe (Int.)/<br/>BOWA (Int.)<br/>R. Wolf HF surgical generator 400 kHz<br/>2260001</p>                      | HF connection cable<br>mono L 3 m | <b>815.033</b> |
|  |  | HF connection cable<br>mono L 5 m | <b>815.053</b> |
|  |  <p>BOWA (Int./EU)<br/>Eschmann and other devices with<br/>4 mm plugs<br/>R. Wolf HF surgical generator 400 kHz<br/>2260001</p> | HF connection cable<br>mono L 3 m | <b>815.034</b> |
|  |  | HF connection cable<br>mono L 5 m | <b>815.054</b> |

1123 | Subject to modifications. Please note that some products may not be available in all countries. Please always take note of the information that is provided with the product. For more detailed information, please consult with your contact partner or directly with Richard Wolf GmbH.

# HF CONNECTION CABLE MONO 8106XXX









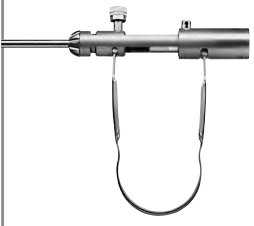

| Instrument connector   | Device connector   |  | Product no.                       |                 |
|--|--|--|-----------------------------------|-----------------|
| <p><b>WOLF Instruments/surgical generator</b></p>  |  <p>ERBE (ACC/ICC/IO)/BOWA (EU)<br/>R. Wolf HF surgical generator 400 kHz<br/>2260002</p> | HF connection cable<br>mono L 3 m  | <b>8106.032</b>                   |                 |
|  |  | HF connection cable<br>mono L 5 m  | <b>8106.052</b>                   |                 |
|  |  <p>ERBE (T series)</p>   | HF connection cable<br>mono L 3 m  | <b>8106.132</b>                   |                 |
|  |  | HF connection cable<br>mono L 5 m  | <b>8106.152</b>                   |                 |
|  | <p><b>HF electrodes, monopolar</b></p>    |  <p>Martin (M-version)/Berchtold/<br/>Aesculap</p>  | HF connection cable<br>mono L 3 m | <b>8106.031</b> |
|  |  |  | HF connection cable<br>mono L 5 m | <b>8106.051</b> |
|  |  |  <p>Bovie/Valleylab/Erbe (Int.)/<br/>BOWA (Int.)<br/>R. Wolf HF surgical generator 400 kHz<br/>2260001</p>                              | HF connection cable<br>mono L 3 m | <b>8106.033</b> |
|  |  |  | HF connection cable<br>mono L 5 m | <b>8106.053</b> |
|  |  |  <p>BOWA (Int./EU)<br/>Eschmann and other devices with<br/>4 mm plugs<br/>R. Wolf HF surgical generator 400 kHz<br/>2260001/2260002</p> | HF connection cable<br>mono L 3 m | <b>8106.034</b> |
|  |  |  | HF connection cable<br>mono L 5 m | <b>8106.054</b> |

# BIPO HF CONNECTION CABLE

8108xxx





DEVICES / ACCESSORIES

10

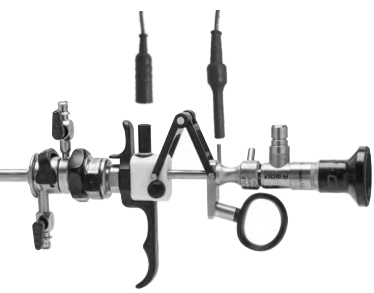

| Instrument connector   | Device connector   |   | Product no.                        |                 |
|--|--|---|------------------------------------|-----------------|
|  <p><b>WOLF Bipolar forceps</b></p>   |  <p>ERBE (ACC/ICC/T)/BOWA (EU)<br/>R. Wolf HF surgical generator 400 kHz<br/>2260001/2260002</p>      | HF connection cable<br>bipo; L 3 m  | <b>8108.032</b>                    |                 |
|  |  | HF connection cable<br>bipo; L 5 m  | <b>8108.052</b>                    |                 |
|  |  <p>International / 2-pin Valleylab<br/>R. Wolf HF surgical generator 400 kHz<br/>2260001/2260002</p> | HF connection cable<br>bipo; L 3 m  | <b>8108.033</b>                    |                 |
|  |  | HF connection cable<br>bipo; L 5 m  | <b>8108.053</b>                    |                 |
|  |  <p>WOLF/Martin (M-version)/<br/>Berchtold/Aesculap</p>  | HF connection cable<br>bipo; L 3 m  | <b>8108.031</b>                    |                 |
|  |  | HF connection cable<br>bipo; L 5 m  | <b>8108.051</b>                    |                 |
|  |  <p>EMC Dolley</p>  | HF connection cable<br>bipo; L 3 m  | <b>8108035</b>                     |                 |
|  |  |   |                                    |                 |
|  |  <p><b>Bipolar tweezers connection</b></p>  |  <p>ERBE (ACC/ICC/T)/BOWA (EU)<br/>R. Wolf HF surgical generator 400 kHz<br/>2260001/2260002</p> | HF connection cable<br>bipo; L 3 m | <b>8108.132</b> |
|  |  |   | HF connection cable<br>bipo; L 5 m | <b>8108.152</b> |
|  <p>International / 2-pin Valleylab<br/>R. Wolf HF surgical generator 400 kHz<br/>2260001/2260002</p> |  | HF connection cable<br>bipo; L 3 m  | <b>8108.133</b>                    |                 |
|  |  | HF connection cable<br>bipo; L 5 m  | <b>8108.153</b>                    |                 |
|  <p>Martin (M-version)/Berchtold/<br/>Aesculap</p>  |  | HF connection cable<br>bipo; L 3 m  | <b>8108.131</b>                    |                 |
|  |  | HF connection cable<br>bipo; L 5 m  | <b>8108.151</b>                    |                 |
|  <p>EMC Dolley</p>  |  | HF connection cable<br>bipo; L 3 m  | <b>8108135</b>                     |                 |
|  |  |   |                                    |                 |

1123 | Subject to modifications. Please note that some products may not be available in all countries. Please always take note of the information that is provided with the product. For more detailed information, please consult with your contact partner or directly with Richard Wolf GmbH.

## HF CONNECTION CABLE BIPO FOR RESECTION IN SALINE SOLUTION

| Instrument connector  | Device connector  |  | Product no.             |
|---|---|--|-------------------------|
| <p><b>WOLF S(a)line resectoscopes</b></p>  | <br>Erbe VIO 300D  | <p><b>Bipolar cable; TUR/TCR; WOLF</b></p> <p>MF plug; L 4 m</p> | <p><b>20196-119</b></p> |
|   | <br>Erbe VIO 3   | <p><b>BIPOLAR CABLE; MF-U</b></p> <p>MF plug; L 4.5 m</p>        | <p><b>21196-119</b></p> |
|   | <br>KLS Martin   | <p><b>HF connection cable bipo; L 3 m</b></p>                    | <p><b>8108.231</b></p>  |
|   |   | <p><b>HF connection cable bipo; L 5 m</b></p>                    | <p><b>8108.251</b></p>  |
|   | <br>R. Wolf HF surgical generator 400 kHz<br>2260001/2260002 |  | <p><b>8108233</b></p>   |
|   |   | <p><b>HF connection cable bipo; L 5 m</b></p>                    | <p><b>8108253</b></p>   |

# MONO HF NEUTRAL ELECTRODE CABLE

| Instrument connector   | Device connector   |  | Product no.           |
|--|--|--|-----------------------|
| <p><b>2-pole neutral electrode</b></p>  |  <p>R. Wolf HF surgical generator 400 kHz<br/>2260001/2260002</p> | <p><b>Mono HF neutral electrode cable, L 4.5 m</b></p> | <p><b>2260031</b></p> |

1123 | Subject to modifications. Please note that some products may not be available in all countries. Please always take note of the information that is provided with the product. For more detailed information, please consult with your contact partner or directly with Richard Wolf GmbH.



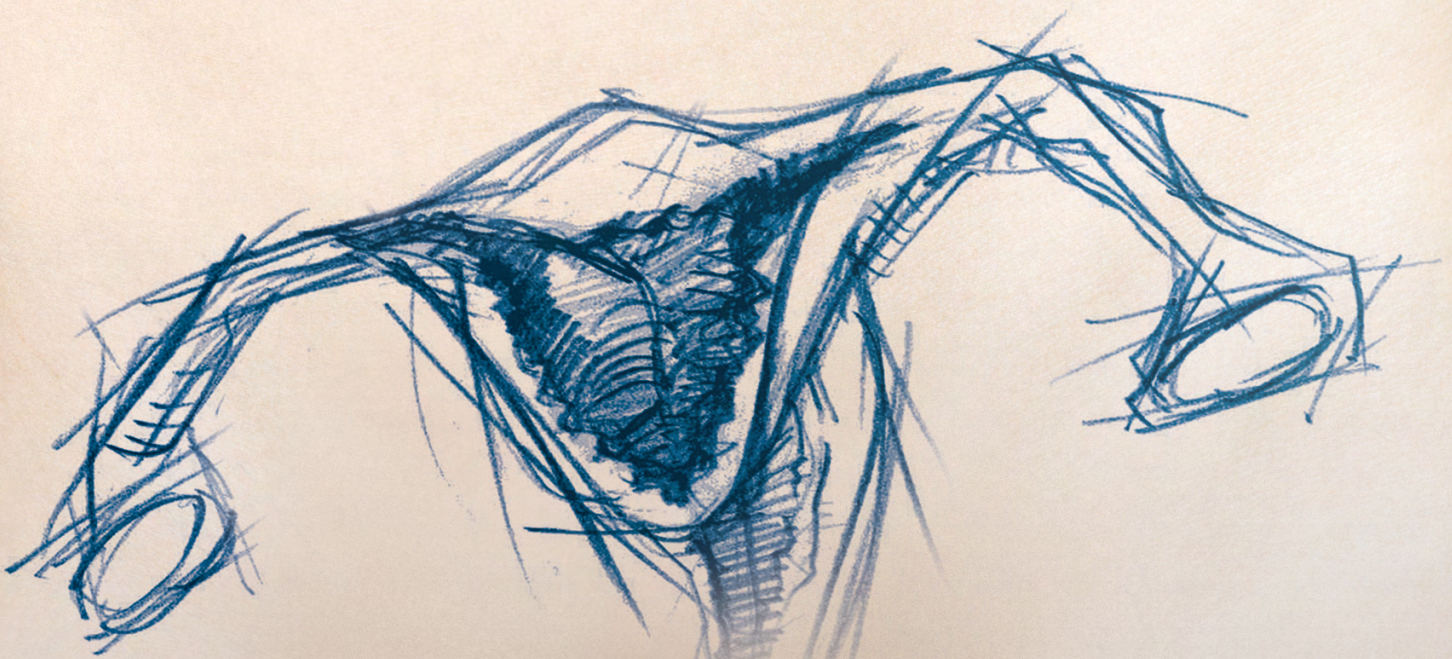

# INTERDISCIPLINARY APPLICATIONS

CYSTO-URETHROSCOPY

## INTERDISCIPLINARY APPLICATIONS

1

---

**CYSTO-URETHROSCOPE 8650 FOR TELESCOPE 4 MM, 0°, 5°, 30°, 70° (TVT)**

---

2

---

**CYSTOSCOPE 14, 17 FR, 25°**

---

# CYSTO-URETHROSCOPE 8650

*E-line*

FOR TELESCOPE 4 MM, 0°, 12°, 30°, 70° AND ADAPTERS

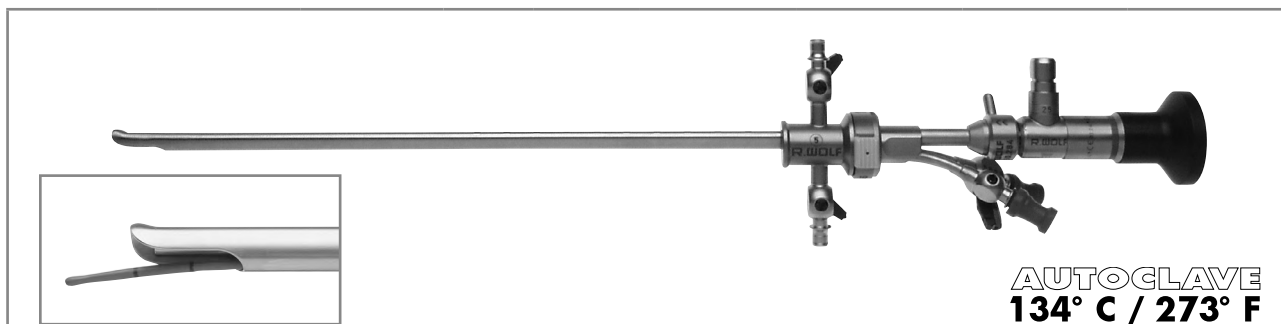

| Sheaths and obturators |  |  |  |  |  | Adapters |  |  |
|------------------------|--|--|--|--|--|----------|--|--|
|------------------------|--|--|--|--|--|----------|--|--|



| Sheath for cystoscope with obturator | Sheath for cystoscope single | Obturator for cystoscope single | Fr      | Color coding | Capacity in Fr | Adapter for cystoscope TL 60 mm | Adapter for cystoscope TL 60 mm | Adapter for cystoscope TL 60 mm |
|--------------------------------------|------------------------------|---------------------------------|---------|--------------|----------------|---------------------------------|---------------------------------|---------------------------------|
| <b>8650.0141</b>                     | <b>8650.0145</b>             | <b>8650.0147</b>                | 16 FR   | yellow       | 1x5*           | <b>8650.254</b>                 | <b>8650.264</b>                 | <b>8650.284</b>                 |
| <b>8650.0241</b>                     | <b>8650.0245</b>             | <b>8650.0247</b>                | 17.5 FR | green        | 1x5 oder 2x4   |                                 |                                 |                                 |
| <b>8650.0341</b>                     | <b>8650.0345</b>             | <b>8650.0347</b>                | 19.5 FR | red          | 1x7 oder 2x5   |                                 |                                 |                                 |
| <b>8650.0441</b>                     | <b>8650.0445</b>             | <b>8650.0447</b>                | 21 FR   | blue         | 1x10 oder 2x6  |                                 |                                 |                                 |
| <b>8650.0541</b>                     | <b>8650.0545</b>             | <b>8650.0547</b>                | 23 FR   | white        | 1x12 oder 2x7  |                                 |                                 |                                 |
| <b>8650.0641</b>                     | <b>8650.0645</b>             | <b>8650.0647</b>                | 25 FR   | black        | 1x5            |                                 |                                 |                                 |

also:



|                                | Direction of view | Ø    | WL     | TL     | Product no.     |
|--------------------------------|-------------------|------|--------|--------|-----------------|
| Telescope 0° Ø 4 mm NL 298 mm  | 0°                | 4 mm | 298 mm | 365 mm | <b>8650.414</b> |
| Telescope 12° Ø 4 mm NL 297 mm | 12°               |      | 297 mm | 363 mm | <b>8654.431</b> |
| Telescope 30° Ø 4 mm NL 300 mm | 30°               |      | 300 mm | 364 mm | <b>8654.422</b> |
| Telescope 70° Ø 4 mm NL 302 mm | 70°               |      | 302 mm | 364 mm | <b>8650.415</b> |

| Recommended accessories | Product no. |
|-------------------------|-------------|
|-------------------------|-------------|

|  |  |                  |
|--|--|------------------|
| <b>Perforated basket for standard telescope 2</b>  | Internal dimensions (W x H x D): 454 x 52 x 40 mm<br>External dimensions (W x H x D): 481 x 54 x 59 mm | <b>38016</b>     |
| <b>Fiber light cable bndl</b><br>consisting of:<br>Fiber light cable (80662523), projector-side adapter (8095.07), and endoscope-side adapter (809509) | Ø 2.5 mm, 2.3 m long   | <b>806625231</b> |





||23|| Subject to modifications. Please note that some products may not be available in all countries. Please always take note of the information that is provided with the product. For more detailed information, please consult with your contact partner or directly with Richard Wolf GmbH.

# CYSTO-URETHROSCOPE 8650

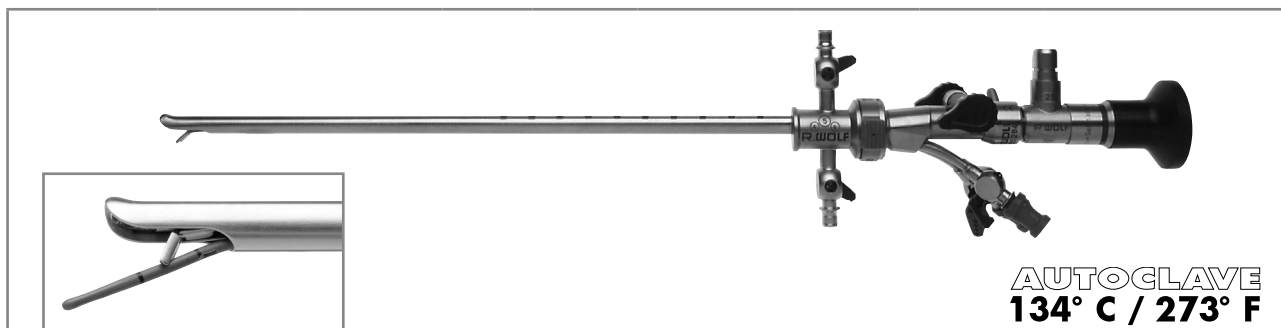
*E-line*

FOR TELESCOPE 4 MM, 30°, 70° AND INSERTS WITH ALBARRAN LEVER



| Sheaths and obturators  |                              |                                 |                   |              |                   | Inserts with Albarran lever  |   |
|---|------------------------------|---------------------------------|-------------------|--------------|-------------------|--|---|
|          |                              |                                 |                   |              |                   |  |  |
|   |                              |                                 |                   |              | 1 instrument port | 2 instrument ports   |   |
| Sheath for cystoscope with obturator  | Sheath for cystoscope single | Obturator for cystoscope single | Fr                | Color coding | Capacity in Fr    | Working insert for cystoscope 30/70  | Working insert for cystoscope 0/30/70   |
| 8650.0241   | 8650.0245                    | 8650.0247                       | 17.5 FR           | yellow       | 1 x 5 or 2 x 4    | <b>8650.214</b>  | <b>8650.204</b>   |
| 8650.0341   | 8650.0345                    | 8650.0347                       | 19.5 FR           | green        | 1 x 7 or 2 x 5    |  |   |
| 8650.0441   | 8650.0445                    | 8650.0447                       | 21 FR             | red          | 1 x 10 or 2 x 6   |  |   |
| 8650.0541   | 8650.0545                    | 8650.0547                       | 23 FR             | blue         | 1 x 12 or 2 x 7   |  |   |
| also:  |                              |                                 |                   |              |                   |  |   |
|   |                              |                                 | Direction of view | Ø            | WL                | TL   | Product no.   |
| Telescope 30° Ø 4 mm NL 300 mm  |                              |                                 | 30°               | 4 mm         | 300 mm            | 364 mm   | <b>8654.422</b>   |
| Telescope 70° Ø 4 mm NL 302 mm  |                              |                                 | 70°               | 4 mm         | 302 mm            | 364 mm   | <b>8650.415</b>   |

| Recommended accessories  | Product no.  |
|--|--|
| <b>Perforated basket for standard telescope 2</b>  | Internal dimensions (W x H x D): 454 x 52 x 40 mm<br>External dimensions (W x H x D): 481 x 54 x 59 mm<br><b>38016</b> |
| <b>Fiber light cable bndl</b><br>consisting of:<br>Fiber light cable (80662523), projector-side adapter (8095.07), and endoscope-side adapter (809509) | Ø 2.5 mm, 2.3 m long<br><b>806625231</b>   |

||23|| Subject to modifications. Please note that some products may not be available in all countries. Please always take note of the information that is provided with the product. For more detailed information, please consult with your contact partner or directly with Richard Wolf GmbH.



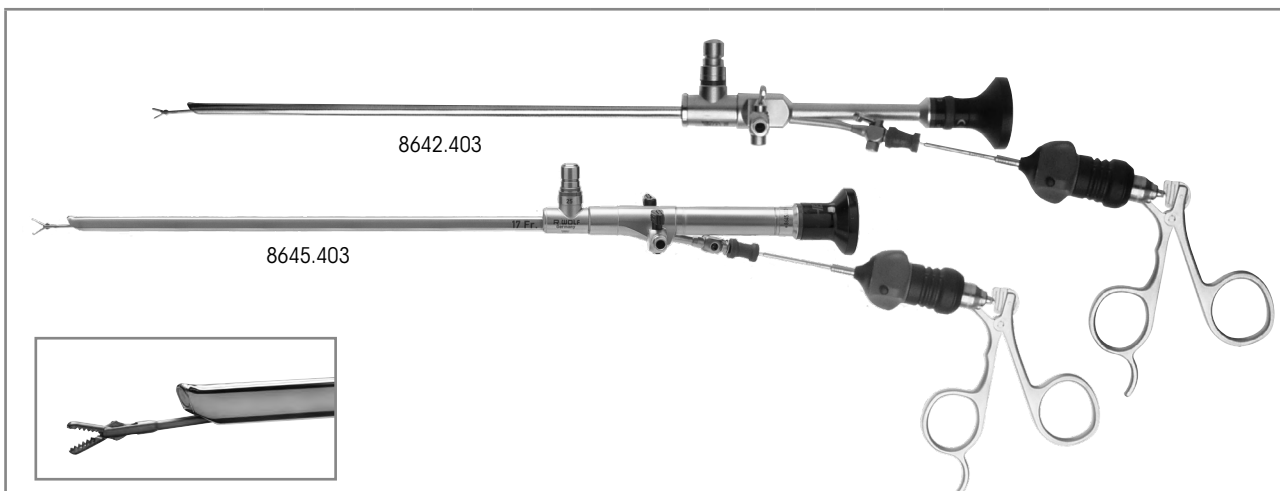

# ATRAUMATIC COMPACT CYSTO-URETHROSCOPE

## 14/17 FR, 25° AND ADAPTERS



|   | Viewing direction | WL     | TL     | Sheath | Working channel           |      | Product no.     |
|---|-------------------|--------|--------|--------|---------------------------|------|-----------------|
|   |                   |        |        |        | for auxiliary instruments | Form |                 |
| <b>Cystoscope 25°, 14 FR, WL 218 mm</b><br>with straight eyepiece,<br>atraumatically shaped tip | 25°               | 218 mm | 358 mm | 14 Fr  | to 5 Fr                   | oval | <b>8642.403</b> |
| <b>Cystoscope 25°, 17 FR, WL 224 mm</b><br>with straight eyepiece,<br>atraumatically shaped tip | 25°               | 224 mm | 364 mm | 17 Fr  | to 7 Fr                   | oval | <b>8645.403</b> |

also:

|   |  | WL     | TL     | Fr | Product no.   |
|---|--|--------|--------|----|---------------|
|  | <b>Flex. biopsy forceps 7 FR WL 375 mm</b>       | 375 mm | 490 mm | 7  | <b>829.07</b> |
|   | <b>Flex. biopsy forceps 5 FR WL 315 mm</b>       | 315 mm | 465 mm | 5  | <b>829.05</b> |
|  | <b>Flex. grasping forceps 7 FR WL 365 mm</b>     | 365 mm | 515 mm | 7  | <b>828.07</b> |
|   | <b>Flex. grasping forceps 5 FR WL 315 mm</b>     | 315 mm | 465 mm | 5  | <b>828.05</b> |
|  | <b>Flex. scissors 7 FR WL 375 mm</b>             | 375 mm | 490 mm | 7  | <b>830.07</b> |
|  | <b>Coagulation electrode mono 6 FR WL 400 mm</b> | 400 mm | -      | 6  | <b>823.06</b> |
|   | <b>Coagulation electrode mono 5 FR WL 400 mm</b> | 400 mm | -      | 5  | <b>823.05</b> |

**Recommended accessories**

**Product no.**

|   |  |                  |
|---|--|------------------|
| <b>Perforated basket for cysto-urethroscope</b>   | Internal dimensions (W x H x D): 435 x 54 x 73 mm<br>External dimensions (W x H x D): 451 x 64 x 80 mm | <b>38013</b>     |
| <b>Fiber light cable bndl</b><br>consisting of:<br>Fiber light cable (80662523), projector-side adapter (8095.07),<br>and endoscope-side adapter (809509) | Ø 2.5 mm, 2.3 m long   | <b>806625231</b> |

