

## GYNECOLOGY

## GYNECOLOGY

1

---

**GYNECOLOGICAL LAPAROSCOPY**

---

2

---

**HYSTERECTOMY**

---

3

---

**HYSTEROSCOPY**

---

4

---

**INTERDISCIPLINARY APPLICATIONS**

---

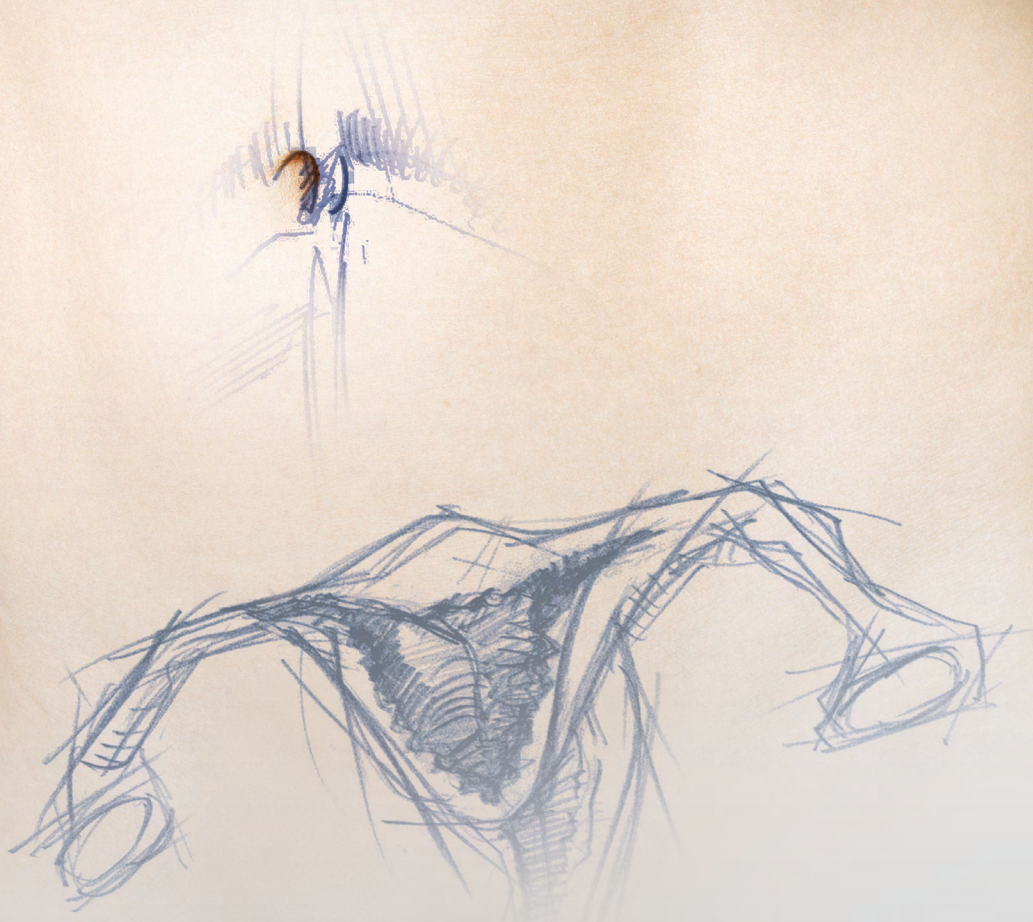

**GYNECOLOGICAL  
LAPAROSCOPY**

## GYNECOLOGICAL LAPAROSCOPY

1

**BASIC SETS**

2

**TELESCOPES**

3

**TROCAR SLEEVES/DILATION/EXTRACTION/REDUCING SLEEVES**

4

**ERAGONMODULAR GRASPING FORCEPS/DISSECTORS/BIOPSY FORCEPS/SCISSORS**

5

**GRASPING FORCEPS**

6

**BIPOLAR FORCEPS AND SCISSORS**

7

**HF ELECTRODES (MONOPOLAR/BIPOLAR)**

8

**MULTIFUNCTIONAL SUCTION IRRIGATION SYSTEM**

9

**TISSUE RETRACTOR**

10

**CLIP APPLICATOR**

11

**NEEDLE HOLDER/KNOT PUSHER/FASCIA CLOSURE**

12

**CANNULAS/SURGICAL PROBES/MYOMA DRILLS**

13

**DEVICES/ACCESSORIES**

14

**CHOLEDOCHOSCOPY**

15

**TRAINING MODELS**

## BASIC SET

### FOR ALL LAPAROSCOPIC PROCEDURES

Product	Product no.	Quantity	Catalog / Section
Insufflator 45 EVAC + HEAT bndl	<b>22350311</b>	1	Laparoscopy / 14
VERES cannula Ø 2.1 mm WL 152 mm	<b>8302.12</b>	1	Laparoscopy / 3
LAP suction irrigation pump bndl	<b>22160011</b>	1	Laparoscopy / 14
LED light source ENDOLIGHT LED 2.1 bndl	<b>51630011</b>	1	Imaging / Light sources
Fiber light cable		1	Imaging / Light cables
ENDOCAM Logic HD	<b>5525</b>	1	Imaging / ENDOCAM
Monitors		1	Imaging / Monitors
Device cart		1	Imaging / Device cart

## BASIC SET

### FOR LAPAROSCOPIC CHOLECYSTECTOMY

Product	Product no.	Quantity	Catalog / Section
Telescope 30° Ø 10 mm WL 307 mm	<b>8934.432</b>	1	Laparoscopy / 2
and/or			
Telescope 0° Ø 10 mm WL 307 mm	<b>8934.431</b>	1	Laparoscopy / 2
Fiber light cable bndl	<b>806650231</b>	1	Laparoscopy / 2
Trocar sleeve, slanted, capacity 5.5 mm WL 100 mm	<b>8921.013</b>	2-3	Laparoscopy / 3
and/or			
Trocar sleeve, straight, capacity 5.5 mm WL 102 mm	<b>8919.351</b>	2-3	Laparoscopy / 3
Trocar sleeve, slanted, capacity 10 mm WL 100 mm	<b>8923.013</b>	2	Laparoscopy / 3
Guide rod 5.5 mm TL 500 mm	<b>8923.921</b>	1	Laparoscopy / 3
Instrument sleeve 10 mm WL 170 mm	<b>8385.50</b>	1	Laparoscopy / 3
VERES cannula Ø 2.1 mm WL 152 mm	<b>8302.12</b>	1	Laparoscopy / 3
Multifunctional suction irrigation system			
Suction irrigation tube Ø 5 mm WL 310 mm	<b>8383.911</b>	1	Laparoscopy / 8
Suction irrigation handle	<b>8385.901</b>	1	Laparoscopy / 8
Sealing cap	<b>8385.902</b>	1	Laparoscopy / 8
<b>ERAGONmodular</b>			
Atraumatic grasping forceps Ø 5 mm bndl	<b>83932925</b>	1	Laparoscopy / 4
Atraumatic grasping forceps mono Ø 5 mm bndl	<b>83931817</b>	2	Laparoscopy / 4
Maryland dissector forceps mono Ø 5 mm bndl	<b>83932817</b>	1	Laparoscopy / 4
Metzenbaum scissors Ø 5 mm bndl	<b>83930417</b>	1	Laparoscopy / 4
Grasping forceps Ø 10 mm bndl	<b>83952048</b>	1	Laparoscopy / 4
Plate-shaped grasping forceps Ø 10 mm bndl	<b>83952347</b>	1	Laparoscopy / 4
<b>Hook electrode mono Ø 5 mm WL 340 mm</b>			
Clip applicator Ø 10 mm WL 340 mm	<b>8389.911</b>	1	Laparoscopy / 10
Ethicon® Ligaclips® (PACK= 108 PCS)	<b>8389.915</b>	1	Laparoscopy / 10
Needle forceps Ø 2.45 mm WL 160 mm	<b>8756.201</b>	1	Laparoscopy / 11
Sealing cone Ø 12-15 mm	<b>8943.915</b>	1	Laparoscopy / 11
Monopolar HF cable	<b>8106</b>	2	Laparoscopy / 14

# BASIC SET

## FOR LAPAROSCOPIC CHOLECYSTECTOMY

Product	Product no.	Quantity	Catalog / Section
Also on request:			
Telescope 30° Ø 5.3 mm WL 303 mm	<b>8935442</b>	1	Laparoscopy / 2
Trocar sleeve, slanted, capacity 5.5 mm WL 100 mm	<b>8921.013</b>	1	Laparoscopy / 3
Trocar tip sharp size 5.5 mm WL 169 mm	<b>8921.113</b>	1	Laparoscopy / 3
ERAGONmodular			
Atraumatic grasping forceps mono Ø 5 mm bndl	<b>83931957</b>	1	Laparoscopy / 4
Biopsy forceps mono Ø 5 mm bndl	<b>83930937</b>	1	Laparoscopy / 4
Dissector forceps Ø 10 mm bndl	<b>83952268</b>	1	Laparoscopy / 4
ERAGONbipolar			
Grasping forceps bipo Ø 5.5 mm bndl	<b>839300312</b>	1	Laparoscopy / 6

In addition to laparoscopic choledochus revision			
Grasping forceps Ø 5 mm WL 295 mm	<b>8383311</b>	1	Laparoscopy / 5

11123 || Subject to modifications. Please note that some products may not be available in all countries. Please always take note of the information that is provided with the product. For more detailed information, please consult with your contact partner or directly with Richard Wolf GmbH.

## BASIC SET

### FOR LAPAROSCOPIC APPENDECTOMY

Product	Product no.	Quantity	Catalog / Section
Telescope 30° Ø 10 mm WL 307 mm	<b>8934.432</b>	1	Laparoscopy / 2
and/or			
Telescope 0° Ø 10 mm WL 307 mm	<b>8934.431</b>	1	Laparoscopy / 2
Fiber light cable bndl	<b>806650231</b>	1	Laparoscopy / 2
Trocar sleeve, slanted, capacity 10 mm WL 100 mm	<b>8923.013</b>	2	Laparoscopy / 3
Trocar tip sharp size 10 mm	<b>8923.113</b>	2	Laparoscopy / 3
and/or			
Trocar sleeve, straight, capacity 5.5 mm WL 102 mm	<b>8919.351</b>	2-3	Laparoscopy / 3
Trocar tip sharp size 5.5 mm WL 144 mm	<b>8919.3512</b>	2-3	Laparoscopy / 3
Trocar sleeve, slanted, capacity 5.5 mm WL 100 mm	<b>8921.013</b>	2-3	Laparoscopy / 3
Trocar tip sharp size 5.5 mm WL 169 mm	<b>8921.113</b>	2-3	Laparoscopy / 3
Guide rod 5.5 mm TL 500 mm	<b>8923.921</b>	1	Laparoscopy / 3
Instrument sleeve 10 mm WL 170 mm	<b>8385.50</b>	1	Laparoscopy / 3
<b>ERAGONmodular</b>			
Grasping forceps mono Ø 5 mm bndl	<b>83932877</b>	1	Laparoscopy / 4
Atraumatic grasping forceps mono Ø 5 mm bndl	<b>83931817</b>	2	Laparoscopy / 4
Maryland dissector forceps mono Ø 5 mm bndl	<b>83932817</b>	1	Laparoscopy / 4
Metzenbaum scissors Ø 5 mm bndl	<b>83930417</b>	1	Laparoscopy / 4
Grasping and dissector forceps 5 mm	<b>83932827</b>	1	Laparoscopy / 4
<b>ERAGONbipolar</b>			
Grasping forceps bipo Ø 5.5 mm bndl	<b>839300312</b>	1	Laparoscopy / 6
<b>Multifunctional suction irrigation system</b>			
Suction irrigation tube Ø 5 mm WL 310 mm	<b>83839.11</b>	1	Laparoscopy / 8
Suction irrigation handle	<b>8385.901</b>	1	Laparoscopy / 8
Sealing cap	<b>8385.902</b>	1	Laparoscopy / 8
<b>Surgical probe Ø 5 mm WL 328 mm</b>			
Surgical probe Ø 5 mm WL 328 mm	<b>8383.66</b>	1	Laparoscopy / 12
VERES cannula Ø 2.1 mm WL 152 mm	<b>8302.12</b>	1	Laparoscopy / 3
Bipolar HF cable	<b>8108</b>	1	Laparoscopy / 14
Monopolar HF cable	<b>8106</b>	1	Laparoscopy / 14



# BASIC SET

## FOR LAPAROSCOPIC APPENDECTOMY

Product	Product no.	Quantity	Catalog / Section
Also on request:			
ERAGONmodular			
Dissector forceps mono Ø 5 mm bndl	<b>83932897</b>	1	Laparoscopy / 4
Grasping forceps mono Ø 5 mm bndl	<b>83931837</b>	2	Laparoscopy / 4
Biopsy forceps mono Ø 5 mm bndl	<b>83930917</b>	1	Laparoscopy / 4
Maryland dissector forceps Ø 10 mm bndl	<b>83952257</b>	1	Laparoscopy / 4
Clip applicator Ø 10 mm WL 340 mm	<b>8389.911</b>	1	Laparoscopy / 10
Ethicon® Ligaclips® (PACK= 108 PCS)	<b>8389.915</b>	1	Laparoscopy / 10
Introduction sleeve 10 mm WL 80 mm	<b>8389.991</b>	1	Laparoscopy / 10
Needle holder Ø 5 mm bndl	<b>8393.502</b>	1	Laparoscopy / 11

## BASIC SET LEVD

### LAPAROSCOPIC SINGLE-CHANNEL VARICOCELE DISSECTION

Product	Product no.	Quantity	Catalog / Section
OR endoscope bndl	<b>8920.4011</b>	1	Laparoscopy / 2
Perforated basket for telescope	<b>38008</b>		Laparoscopy / 2
Fiber light cable bndl	<b>806625231</b>	1	Laparoscopy / 2
Trocar sleeve, straight, capacity 5.5 mm WL 102 mm	<b>8919.353</b>	1	Laparoscopy / 3
Optional:			
Trocar tip blunt size 5.5 mm WL 144 mm	<b>8919.3511</b>	1	Laparoscopy / 3
Trocar tip sharp size 5.5 mm WL 144 mm	<b>8919.3512</b>	1	Laparoscopy / 3
Trocar tip triangular size 5.5 mm WL 144 mm	<b>8919.3513</b>	1	Laparoscopy / 3
ERAGONmodular mini			
Universal grasping forceps Ø 3.5 mm bndl	<b>83912097</b>	1	Laparoscopy / 4
Atraumatic grasping forceps Ø 3.5 mm bndl	<b>83912087</b>	1	Laparoscopy / 4
Babcock forceps Ø 3.5 mm bndl	<b>83912107</b>	1	Laparoscopy / 4
Dissector forceps mono Ø 3.5 mm bndl	<b>83912077</b>	1	Laparoscopy / 4
Hook scissors mono Ø 3.5 mm bndl	<b>83912277</b>	1	Laparoscopy / 4
Metzenbaum scissors mono Ø 3.5 mm bndl	<b>83912247</b>	1	Laparoscopy / 4
Connection cable			
Bipolar HF cable	<b>8108</b>	1	Laparoscopy / 14
Monopolar HF cable	<b>8106</b>	1	Laparoscopy / 14

# BASIC SET

## MINI E-MILOS

Product	Product no.	Quantity	Catalog / Section
Telescope 30° Ø 10 mm WL 307 mm	<b>8934.432</b>	1	Laparoscopy / 2
Light tube for MILOS method Ø 10 mm	<b>893420</b>	1	Laparoscopy / 2
Trocar sleeve, straight, capacity 3.5 mm WL 100 mm	<b>8903.014</b>	2	Laparoscopy / 3
Trocar tip blunt size 3.5 mm WL 169 mm	<b>8903.103</b>	2	Laparoscopy / 3
<b>ERAGONmodular mini</b>			
Handle, pistol-shaped, mono	<b>83930073</b>	4	Laparoscopy / 4
Sheath tube insulated Ø 3.5 mm SL 330 mm	<b>8391933</b>	4	Laparoscopy / 4
Dissector forceps insert Ø 3.5 mm	<b>8391222</b>	1	Laparoscopy / 4
Metzenbaum scissors insert Ø 3.5 mm	<b>8391215</b>	1	Laparoscopy / 4
Grasping forceps insert Ø 3.5 mm	<b>8391208</b>	2	Laparoscopy / 4
<b>Electrode</b>			
Hook electrode mono Ø 3.5 mm WL 310 mm	<b>8379.452</b>	1	Laparoscopy / 7
<b>ERAGONstitch</b>			
Needle holder insert Ø 3.5 mm	<b>8391506</b>	1	Laparoscopy / 11
Sheath tube Ø 3.5 mm SL 330 mm	<b>8391533</b>	1	Laparoscopy / 11
Needle holder handle, axial	<b>8393943</b>	1	Laparoscopy / 11

## BASIC SET

### E-MILOS

Product	Product no.	Quantity	Catalog / Section
Telescope 30° Ø 10 mm WL 307 mm	<b>8934.432</b>	1	Laparoscopy / 2
Light tube for MILOS method Ø 10 mm	<b>893420</b>	1	Laparoscopy / 2
Trocar sleeve, straight, capacity 5.5 mm WL 100 mm	<b>8921.014</b>	2	Laparoscopy / 3
Trocar tip blunt size 5.5 mm WL 169 mm	<b>8921.103</b>	2	Laparoscopy / 3
<b>ERAGONmodular</b>			
Handle, pistol-shaped, mono	<b>83930073</b>	4	Laparoscopy / 4
Sheath tube insulated Ø 5 mm SL 330 mm	<b>8391933</b>	4	Laparoscopy / 4
Dissector forceps insert Ø 5 mm	<b>8393240</b>	1	Laparoscopy / 4
Metzenbaum scissors insert Ø 5 mm	<b>8393.041</b>	1	Laparoscopy / 4
Grasping forceps insert Ø 5 mm	<b>8393.181</b>	2	Laparoscopy / 4
<b>Electrode</b>			
Hook electrode mono Ø 5 mm WL 340 mm	<b>8383.423</b>	1	Laparoscopy / 7
<b>ERAGONstitch</b>			
Needle holder insert Ø 5 mm	<b>8393508</b>	1	Laparoscopy / 11
Sheath tube Ø 5 mm SL 330 mm	<b>8393533</b>	1	Laparoscopy / 11
Needle holder handle, axial	<b>8393943</b>	1	Laparoscopy / 11

## BASIC SET

### LAPAROSCOPIC BARIATRIC SURGERY

Product	Product no.	Quantity	Catalog / Section
Telescope 0° Ø 10 mm WL 305 mm	<b>8934461</b>	1	Laparoscopy / 2
Telescope 30° Ø 10 mm WL 305 mm	<b>8934462</b>	1	Laparoscopy / 2
Fiber light cable bndl	<b>806550231</b>	1	Laparoscopy / 2
Trocar sleeve, straight, capacity 5.5 mm WL 150 mm	<b>8921.016</b>	3	Laparoscopy / 3
Trocar sleeve, straight, capacity 10 mm WL 150 mm	<b>8923.016</b>	1	Laparoscopy / 3
Trocar sleeve, straight, capacity 12.5 mm WL 150 mm	<b>8924.016</b>	1	Laparoscopy / 3
<b>Optional:</b>			
Trocar tip sharp size 5.5 mm	<b>8921.115</b>	3	Laparoscopy / 3
Trocar tip sharp size 10 mm	<b>8923.115</b>	1	Laparoscopy / 3
Trocar tip sharp size 12.7 mm	<b>8924.115</b>	1	Laparoscopy / 3
Reducing adapter	<b>8923.802</b>	1	Laparoscopy / 3
<b>Multifunctional suction irrigation system</b>			
Suction irrigation tube Ø 5 mm WL 450 mm	<b>8384.911</b>	1	Laparoscopy / 8
Suction irrigation handle	<b>8385.901</b>	1	Laparoscopy / 8
Sealing cap	<b>8385.902</b>	1	Laparoscopy / 8
Suction irrigation tube set with piercing spike L 3 m	<b>4170.956</b>	1	Laparoscopy / 8
<b>ERAGONmodular</b>			
Atraumatic grasping forceps mono Ø 5 mm bndl	<b>83941817</b>	1	Laparoscopy / 4
Dissector forceps mono Ø 5 mm bndl	<b>83942407</b>	1	Laparoscopy / 4
Metzenbaum scissors mono Ø 5 mm bndl	<b>83940417</b>	1	Laparoscopy / 4
Atraumatic Grasping forceps Ø 5 mm bndl	<b>83942297</b>	1	Laparoscopy / 4
Biopsy forceps mono Ø 5 mm bndl	<b>83940917</b>	1	Laparoscopy / 4
Atraumatic Grasping forceps Ø 5 mm bndl	<b>83942507</b>	1	Laparoscopy / 4
Stapler head grasping forceps Ø 10 mm bndl	<b>83976558</b>	1	Laparoscopy / 4
Plate-shaped grasping forceps Ø 10 mm bndl	<b>83962347</b>	1	Laparoscopy / 4
Babcock forceps Ø 10 mm bndl	<b>83961877</b>	1	Laparoscopy / 4
<b>ERAGONbipolar</b>			
Maryland dissector bipo Ø 5.5 mm bndl	<b>839400322</b>	1	Laparoscopy / 6
Metzenbaum scissors bipo Ø 5.5 mm bndl	<b>839400412</b>	1	Laparoscopy / 6
<b>Electrode</b>			
Hook electrode mono Ø 5 mm WL 420 mm	<b>8384.423</b>	1	Laparoscopy / 7

## BASIC SET

### LAPAROSCOPIC BARIATRIC SURGERY

Product	Product no.	Quantity	Catalog / Section
Clip applicator Ø 10 mm WL 340 mm	<b>8389.911</b>	1	Laparoscopy / 10
Ethicon® Ligaclips® (PACK= 108 PCS)	<b>8389.915</b>	1	Laparoscopy / 10
Needle holder Ø 5 mm bndl with carbide insert	<b>8394.502</b>	1	Laparoscopy / 11
Needle holder Ø 5 mm bndl curved to the right with carbide insert	<b>8394.511</b>	1	Laparoscopy / 11
Needle forceps Ø 2.45 mm WL 160 mm	<b>8756.201</b>	1	Laparoscopy / 11
Sealing cone Ø 12–15 mm	<b>8943.915</b>	1	Laparoscopy / 11
Sealing cone Ø 10–12 mm	<b>8934.915</b>	1	Laparoscopy / 11
VERES cannula Ø 2.1 mm WL 152 mm	<b>8302.12</b>	1	Laparoscopy / 3
Handle, axial, mono	<b>83930084</b>	1	Laparoscopy / 14
Rotatable knob	<b>8988</b>	1	Laparoscopy / 14
Connection cable			
Mono HF connection cable L 3 m	<b>8106.033</b>	1	Laparoscopy / 13
Bipo HF connection cable L 3 m	<b>8108.132</b>	1	Laparoscopy / 13

# MINI FIBER TELESCOPES 2.0 MM

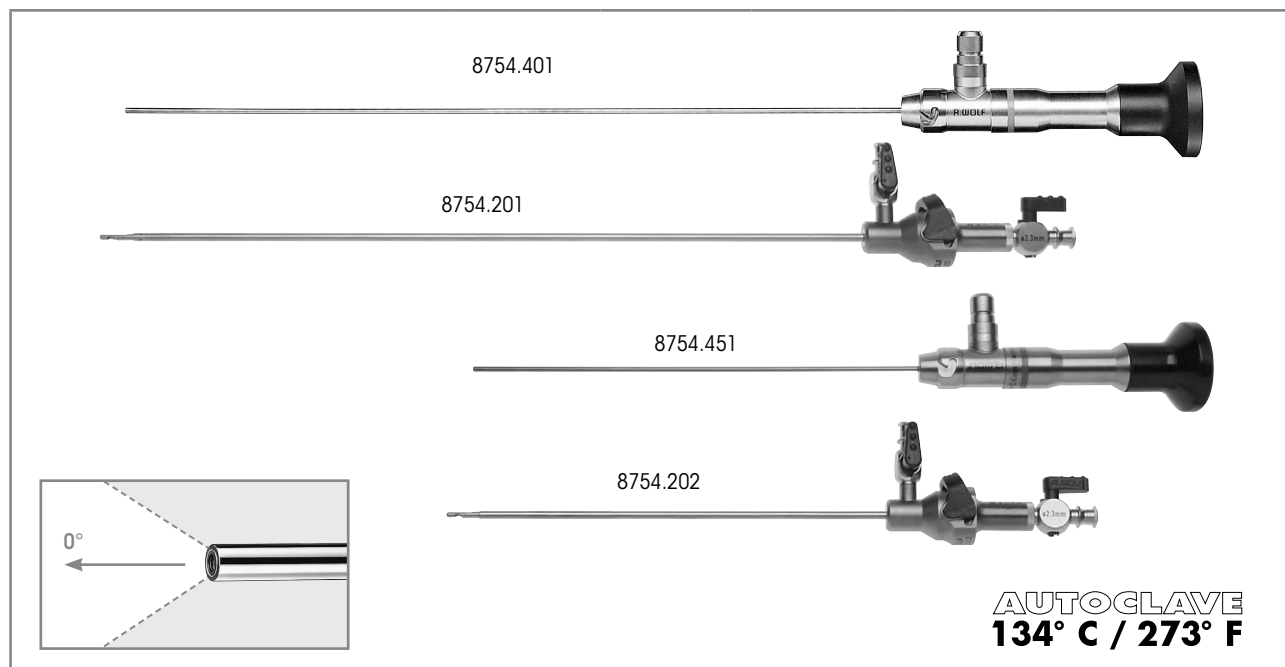

Long version	Direction of view	WL	TL	Ø	Product no.
Telescope 0° Ø 2 mm NL 268 mm	0°	268 mm	365 mm	2.0 mm	<b>8754.401</b>
<b>for this:</b>					
<b>VERES cannula Ø 2.3 mm WL 250 mm</b> consisting of: 1x VERES cannula Ø 2.3 mm WL 274 mm (8754.211) 1x outer sheath Ø 2.8 mm, WL 250 mm (8754.221)		250 mm		2.3 mm	<b>8754.201</b>
Short version	Direction of view	WL	TL	Ø	Product no.
Telescope 0° Ø 2 mm NL 158 mm	0°	158 mm	255 mm	2.0 mm	<b>8754.451</b>
<b>for this:</b>					
<b>VERES cannula Ø 2.3 mm WL 170 mm</b> consisting of: 1x VERES cannula Ø 2.3 mm WL 164 mm (8754.212) 1x outer sheath Ø 2.8 mm WL 141 mm (8754.222)		170 mm		2.3 mm	<b>8754.202</b>
Recommended accessories					Product no.
Perforated basket for standard telescope 1 (for telescope 8754.451)		(W x H x D) 297 x 54 x 59 mm			<b>38015</b>
Perforated basket for standard telescope 2 (for telescope 8754.401)		(W x H x D) 481 x 54 x 59 mm			<b>38016</b>
<b>Fiber light cable bndl</b> consisting of: Fiber light cable (80662523), projector-side adapter (8095.07), and endoscope-side adapter (809509)		Ø 2.5 mm, 2.3 m long			<b>806625231</b>

11123 || Subject to modifications. Please note that some products may not be available in all countries. Please always take note of the information that is provided with the product. For more detailed information, please consult with your contact partner or directly with Richard Wolf GmbH.

# LAPAROSCOPES 3.5 MM

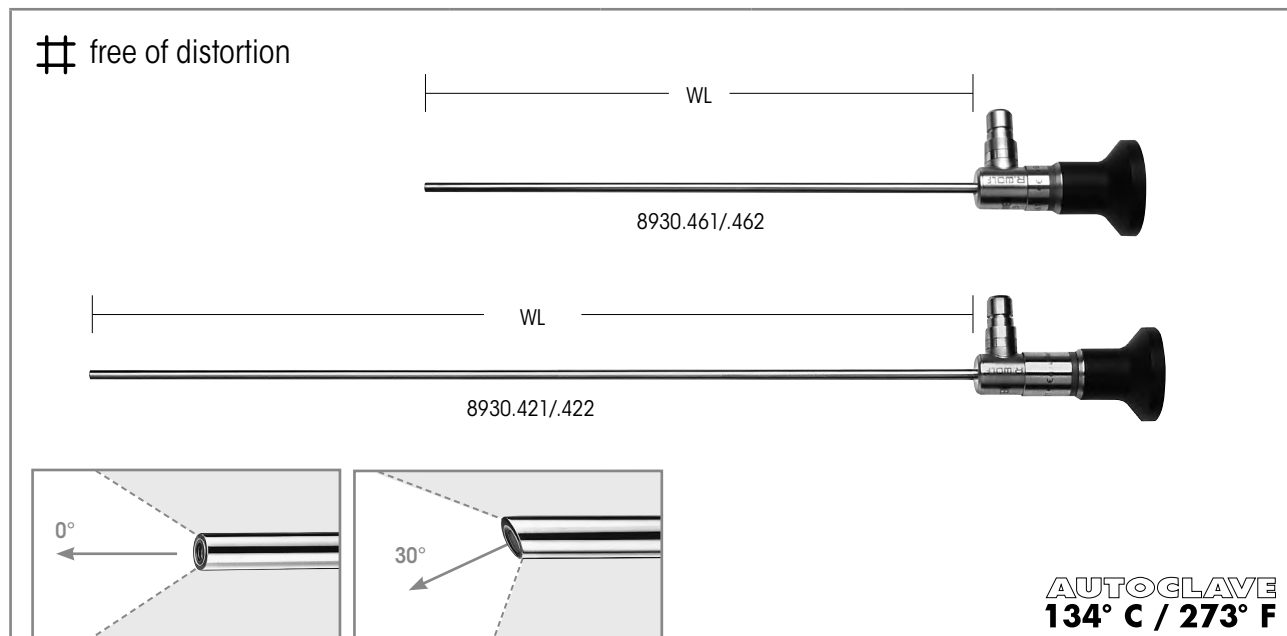

	Direction of view	WL	TL	Ø	Product no.
PANOVIEW PLUS Telescope 0° 3.5 mm WL 180 mm	0°	180 mm	232 mm	3.5 mm	<b>8930.461</b>
PANOVIEW PLUS Telescope 30° 3.5 mm WL 180 mm	30°		233 mm		<b>8930.462</b>
PANOVIEW PLUS Telescope 0° Ø 3.5 mm WL 300 mm	0°	300 mm	361 mm		<b>8930.421</b>
PANOVIEW PLUS Telescope 30° 3.5 mm WL 300 mm	30°		362 mm		<b>8930.422</b>

Recommended accessories		Product no.
<b>Perforated basket for standard telescope 1</b> (for telescope 8930.461/.462)	(W x H x D) 297 x 54 x 59 mm	<b>38015</b>
<b>Perforated basket for standard telescope 2</b> (for telescope 8930.421/.422)	(W x H x D) 481 x 54 x 59 mm	<b>38016</b>
<b>Fiber light cable bndl</b> consisting of: Fiber light cable (80662523), projector-side adapter (8095.07), and endoscope-side adapter (809509)	Ø 2.5 mm, 2.3 m long	<b>806625231</b>

|||23 || Subject to modifications. Please note that some products may not be available in all countries. Please always take note of the information that is provided with the product. For more detailed information, please consult with your contact partner or directly with Richard Wolf GmbH.



# LAPAROSCOPES 5.3 MM

# free of distortion

full screen

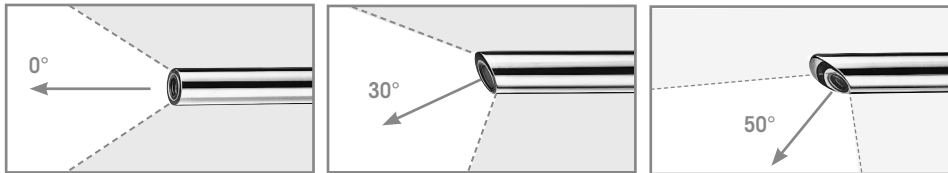
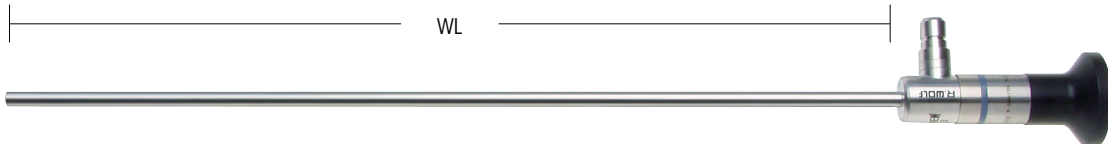

**AUTOCLAVE**  
**134° C / 273° F**

	Direction of view	WL	TL	Ø	Product no.
PANOVIEW Telescope 0° Ø 5.3 mm WL 303 mm	0°	303 mm	372 mm	5.3 mm	<b>8935.441</b>
PANOVIEW Telescope 30° Ø 5.3 mm WL 303 mm	30°		373 mm		<b>8935.442</b>
PANOVIEW Telescope 50° Ø 5.3 mm WL 309 mm	50°	309 mm	377 mm		<b>8935.443</b>

Recommended accessories		Product no.
<b>Perforated basket for standard telescope 2</b>	(W x H x D) 481 x 54 x 59 mm	<b>38016</b>
<b>Fiber light cable bndl</b> consisting of: Fiber light cable (80662523), projector-side adapter (8095.07), and endoscope-side adapter (809509)	Ø 2.5 mm, 2.3 m long	<b>806625231</b>

11123 || Subject to modifications. Please note that some products may not be available in all countries. Please always take note of the information that is provided with the product. For more detailed information, please consult with your contact partner or directly with Richard Wolf GmbH.

# MINI OR LAPAROSCOPE

## 5.5 MM WITH 3.5 MM WORKING CHANNEL

TELESCOPES

2

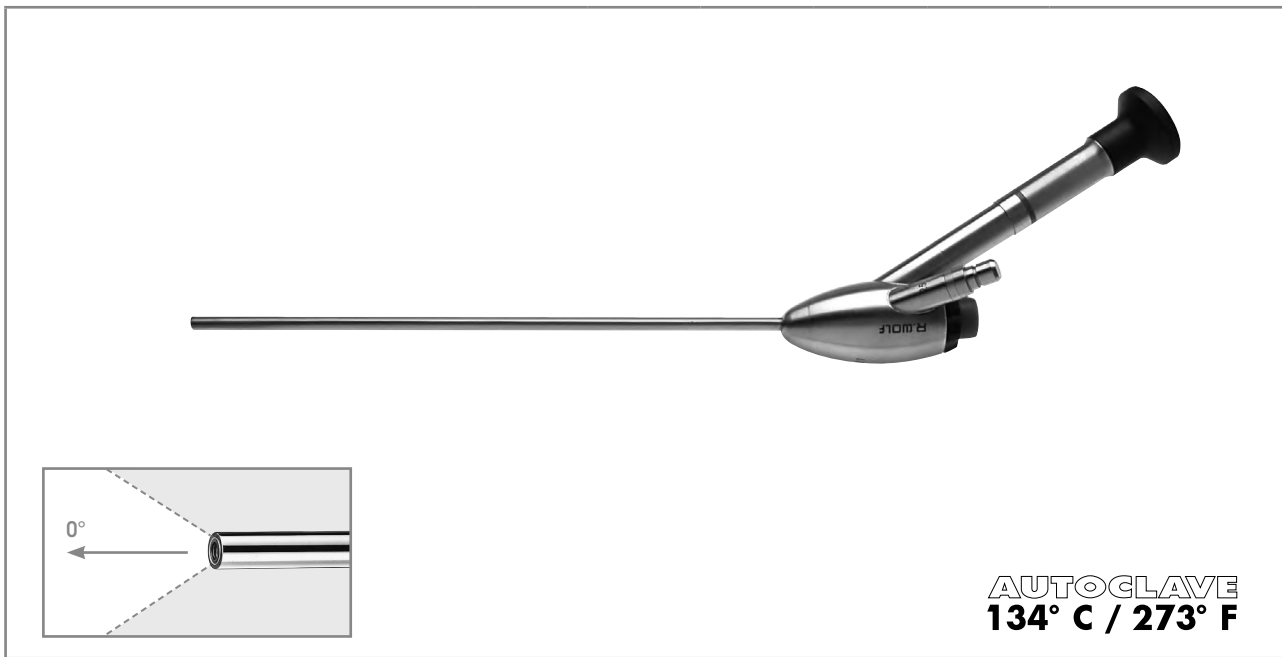

	Direction of view	SL	TL	Ø	Working channel Ø	Product no.
<b>OR endoscope bndl</b> consisting of: OR endoscope 0° Ø 5.5 mm SL 215 mm (8920.401) Autom. sealing element ID 5.7 mm (8920.311) Sealing cap, red-orange (15176.020) Sealing membrane Ø 17 mm (PACK= 10 PCS) (89.103)	0°	215 mm	370 mm	5.5 mm	3.5 mm	<b>8920.4011</b>

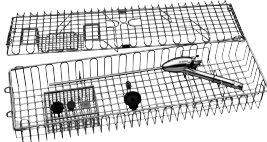
Recommended accessories		Product no.
Trocar sleeve, straight, capacity 5.5 mm WL 62 mm		<b>8919.333</b>
Trocar sleeve, straight, capacity 5.5 mm WL 102 mm		<b>8919.353</b>
<b>Perforated basket for telescope</b> Dimensions (W x L x H): 132 x 467 x 75 mm		<b>38008</b>
<b>Fiber light cable bndl</b> consisting of: Fiber light cable (80663523), projector-side adapter (8095.07), and endoscope-side adapter (809509)	Ø 3.5 mm, 2.3 m long	<b>806635231</b>

III23 || Subject to modifications. Please note that some products may not be available in all countries. Please always take note of the information that is provided with the product. For more detailed information, please consult with your contact partner or directly with Richard Wolf GmbH.

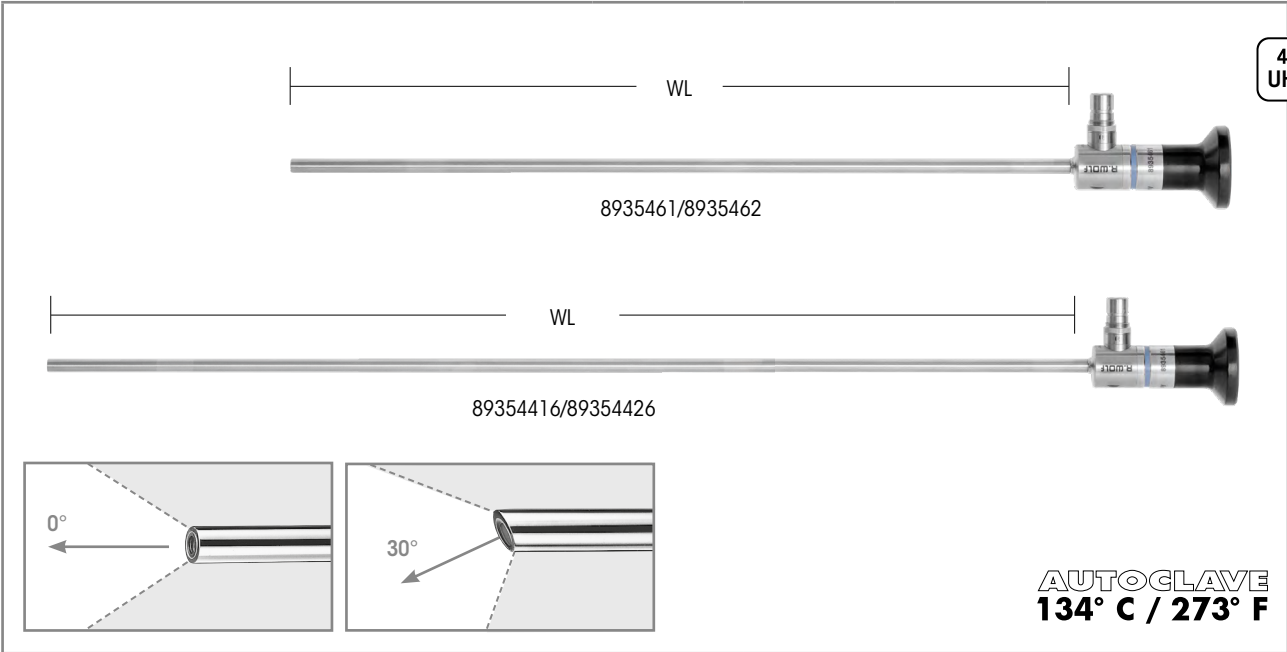

**AUTOGLAVE**  
**134° C / 273° F**

	Direction of view	WL	Ø	Product no.
PANOVIEW ULTRA Telescope Ø 5.5 mm WL 300 mm	0°	300 mm	5.5 mm	<b>8935461</b>
PANOVIEW ULTRA Telescope Ø 5.5 mm WL 300 mm	30°			<b>8935462</b>
PANOVIEW ULTRA Telescope Ø 5.5 mm WL 430 mm	0°	430 mm		<b>89354416</b>
PANOVIEW ULTRA Telescope Ø 5.5 mm WL 430 mm	30°			<b>89354426</b>

Recommended accessories		Product no.
<b>Perforated basket for standard telescope 2</b> (for telescope 8935416/8935426)	(W x H x D) 481 x 54 x 59 mm	<b>38016</b>
<b>Perforated basket for standard telescope 3</b> (for telescope 89354416/89354426)	(W x H x D) 619 x 54 x 59 mm	<b>38017</b>
<b>Fiber light cable bndl</b> consisting of: Fiber light cable (80663523), projector-side adapter (8095.07), and endoscope-side adapter (809509)	Ø 3.5 mm, 2.3 m long	<b>806635231</b>

11123 | Subject to modifications. Please note that some products may not be available in all countries. Please always take note of the information that is provided with the product. For more detailed information, please consult with your contact partner or directly with Richard Wolf GmbH.

# LAPAROSCOPES 10 MM

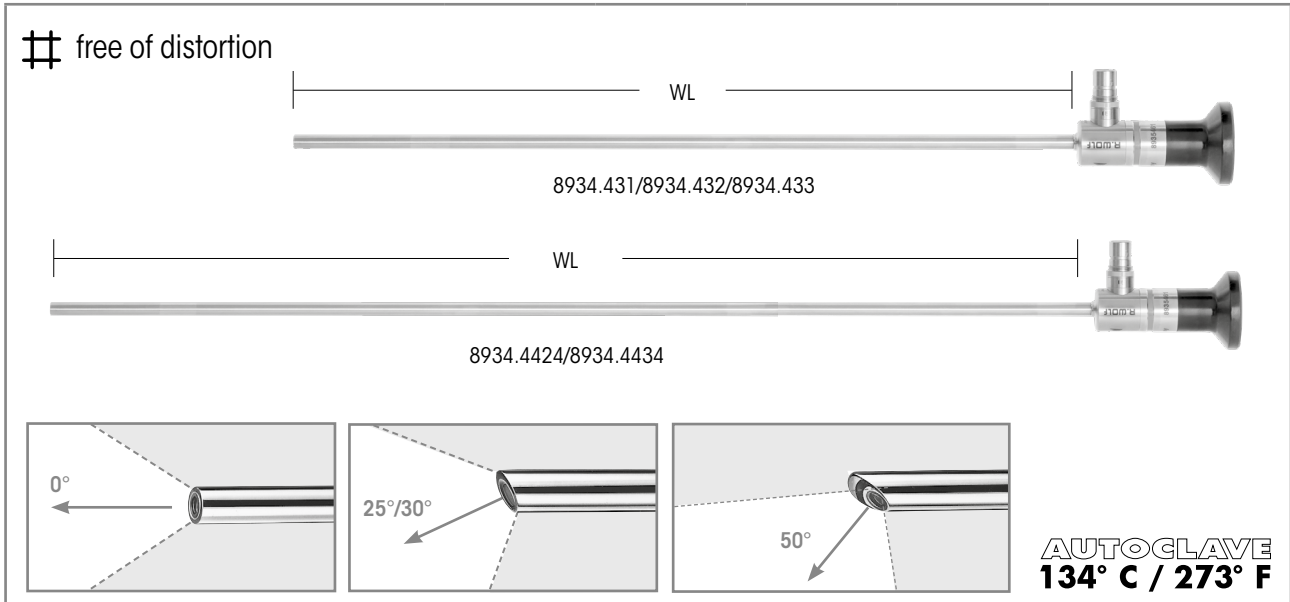

	Direction of view	WL	TL	Ø	Product no.
PANOVIEW Telescope 0° Ø 10 mm WL 307 mm	0°	307 mm	375 mm	10 mm	<b>8934.431</b>
PANOVIEW Telescope 30° Ø 10 mm WL 307 mm	30°	307 mm	375 mm		<b>8934.432</b>
PANOVIEW Telescope 50° Ø 10 mm WL 310 mm	50°	310 mm	378 mm		<b>8934.433</b>
PANOVIEW PLUS Telescope 25° Ø 10 mm WL 438 mm	25°	438 mm	507 mm		<b>8934.4424</b>
PANOVIEW PLUS Telescope 50° Ø 10 mm WL 447 mm	50°	447 mm	516 mm		<b>8934.4434</b>

Recommended accessories		Product no.
<b>Perforated basket for standard telescope 2</b> (for telescope 8934.431/.432/.433)	(W x H x D) 481 x 54 x 59 mm	<b>38016</b>
<b>Perforated basket for standard telescope 3</b> (for telescope 8934.4424/.4434)	(W x H x D) 619 x 54 x 59 mm	<b>38017</b>
<b>Fiber lightcable bndl</b> consisting of: Fiber light cable Ø 5 mm TL 2.3 m (80665023), projector-side adapter (8095.07), and endoscope-side adapter (809509)	Ø 5.0 mm, 2.3 m long	<b>806650231</b>
<b>Fusion Fiber light cable bndl</b> consisting of: Fiber light cable Ø 5 mm TL 2.3 m (80655023), projector-side adapter (8095.07), and endoscope-side adapter (809509)	Ø 5.0 mm, 2.3 m long	<b>806550231</b>

III23 || Subject to modifications. Please note that some products may not be available in all countries. Please always take note of the information that is provided with the product. For more detailed information, please consult with your contact partner or directly with Richard Wolf GmbH.

# 3D ENDOSCOPE 10 MM

11123 | Subject to modifications. Please note that some products may not be available in all countries. Please always take note of the information that is provided with the product. For more detailed information, please consult with your contact partner or directly with Richard Wolf GmbH.

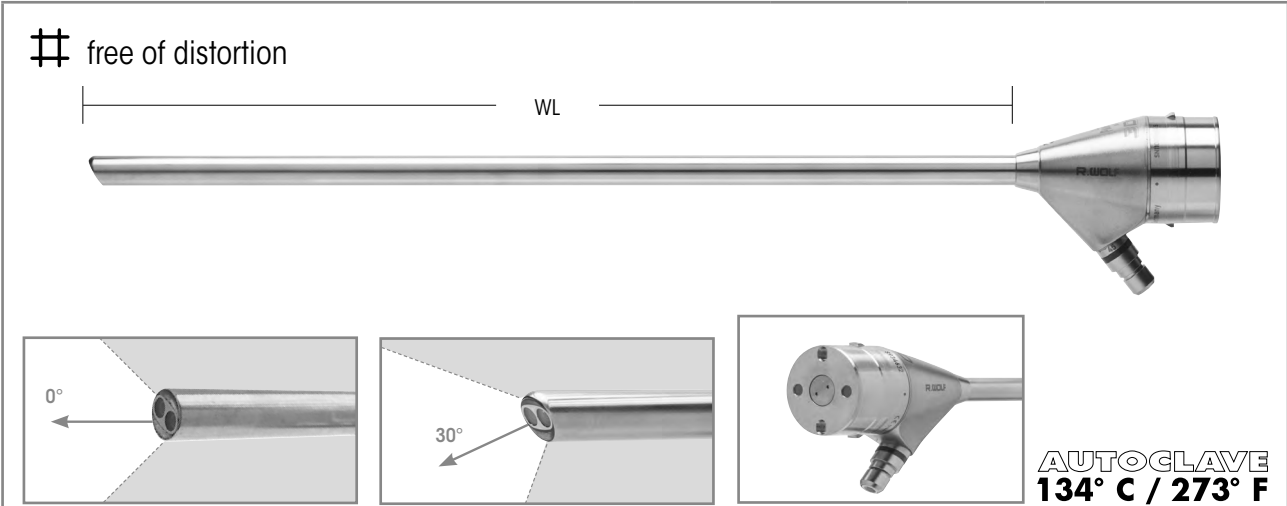

	Direction of view	WL	TL	Ø	Product no.
3D endoscope 0° Ø 10 mm WL 300 mm	0°	300 mm	366 mm	10 mm	8934631
3D endoscope 0° Ø 10 mm WL 435 mm		435 mm	500 mm		89344631
3D endoscope 30° Ø 10 mm WL 301 mm	30°	301 mm	366 mm		8934632
3D endoscope 30° Ø 10 mm WL 435 mm		435 mm	501 mm		89344632

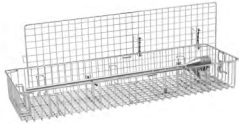
Recommended accessories		Product no.
<b>Perforated basket for 3D telescope</b> 	(W x H x D): 583 x 200 x 80 mm	<b>38014</b>
Fusion <b>Fiber light cable bndl</b> consisting of: Fiber light cable Ø 5 mm TL 2.3 m (80655023), projector-side, adapter (8095.07), and endoscope-side adapter (809509)	Ø 5.0 mm, 2.3 m long	<b>806550231</b>

# SURGICAL LAPAROSCOPE 10 MM

## FOR ONE HOLE APPENDECTOMY

TELESOPES

2

# free of distortion

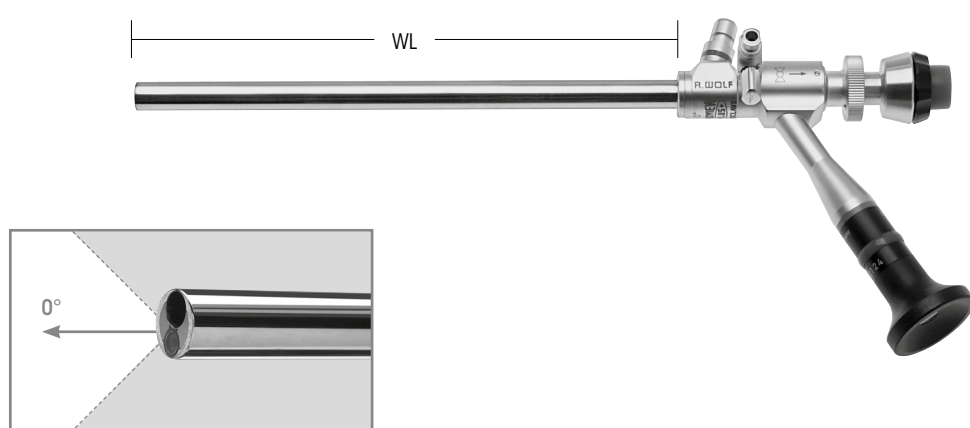

**AUTOCLAVE**  
**134° C / 273° F**

	Direction of view	WL	TL	Ø	Working channel Ø	Product no.
<b>PANOVIEW PLUS</b> <b>OR endoscope 0° Ø 10 mm WL 188 mm</b>  with lateral eyepiece	0°	188 mm	285 mm	10 mm	5.1 mm	<b>8915.501</b>

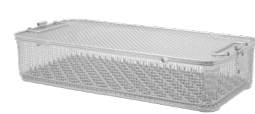
Recommended accessories		Product no.
<b>Universal perforated basket 4</b> (W x H x D): 538 x 117 x 250 mm		<b>33004</b>
for this: <b>Instrument mat for perforated basket</b>		<b>33001</b>
<b>Fiber light cable bndl</b> consisting of: Fiber light cable Ø 5 mm TL 2.3 m (80655023), projector-side adapter (8095.07), and endoscope-side adapter (809509)	Ø 5.0 mm, 2.3 m long	<b>806650231</b>
Fusion <b>Fiber light cable bndl</b> consisting of: Fiber light cable Ø 5 mm TL 2.3 m (80655023), projector-side adapter (8095.07), and endoscope-side adapter (809509)	Ø 5.0 mm, 2.3 m long	<b>806550231</b>

III23 || Subject to modifications. Please note that some products may not be available in all countries. Please always take note of the information that is provided with the product. For more detailed information, please consult with your contact partner or directly with Richard Wolf GmbH.





**AUTOCLAVE**  
**134° C / 273° F**



	Direction of view	WL	TL	Ø	Product no.
PANOVIEW ULTRA Telescope 0° Ø 10 mm WL 305 mm	0°	305 mm	375 mm	10 mm	8934461
PANOVIEW ULTRA Telescope 30° Ø 10 mm WL 305 mm	30°				8934462
PANOVIEW ULTRA Telescope 50° Ø 10 mm WL 305 mm	50°				8934463

**Note:** Compatible with System green (see Imaging Catalog) (ICG/NIR-capable) and its recommended Fusion fiber light cable

Recommended accessories		Product no.
<b>Perforated basket for standard telescope 2</b>	(W x H x D) 481 x 54 x 59 mm	<b>38016</b>
<b>Fiber lightcable bndl</b> consisting of: Fiber light cable Ø 5 mm TL 2.3 m (80665023), projector-side adapter (8095.07), and endoscope-side adapter (809509)	Ø 5.0 mm, 2.3 m long	<b>806650231</b>
<b>Fusion fiber lightcable bndl</b> consisting of: Fiber light cable Ø 5 mm TL 2.3 m (80655023), projector-side adapter (8095.07), and endoscope-side adapter (809509)	Ø 5.0 mm, 2.3 m long	<b>806550231</b>

**AUTOCLAVE**  
**134° C / 273° F**



	Direction of view	WL	TL	Ø	Product no.
PANOVIEW ULTRA Telescope 0° Ø 10 mm WL 440 mm	0°	440 mm	510 mm	10 mm	<b>89344416</b>
PANOVIEW ULTRA Telescope 30° Ø 10 mm WL 440 mm	30°				<b>89344426</b>
PANOVIEW ULTRA Telescope 50° Ø 10 mm WL 440 mm	50°				<b>89344436</b>

**Note:** Compatible with System green (see Imaging Catalog) (ICG/NIR-capable) and its recommended Fusion fiber light cable

Recommended accessories		Product no.
<b>Perforated basket for standard telescope 3</b>	(W x H x D) 619 x 54 x 59 mm	<b>38017</b>
<b>Fiber lightcable bndl</b> consisting of: Fiber light cable Ø 5 mm TL 2.3 m (80665023), projector-side adapter (8095.07), and endoscope-side adapter (809509)	Ø 5.0 mm, 2.3 m long	<b>806650231</b>
Fusion <b>Fiber light cable bndl</b> consisting of: Fiber light cable Ø 5 mm TL 2.3 m (80655023), projector-side adapter (8095.07), and endoscope-side adapter (809509)	Ø 5.0 mm, 2.3 m long	<b>806550231</b>

III23 || Subject to modifications. Please note that some products may not be available in all countries. Please always take note of the information that is provided with the product. For more detailed information, please consult with your contact partner or directly with Richard Wolf GmbH.



**LIGHT TUBE FOR MILOS METHOD  
(MINI LESS OPEN SUBLAY METHOD)**



**AUTOCLAVE  
134° C / 273° F**

		Ø	TL	Product no.
	<b>Light tube for MILOS method Ø 10 mm</b> Instrument channel for 5 mm instruments	10 mm	200 mm	<b>893420</b>

Recommended accessories		Product no.
<b>Fiber light cable bndl</b> consisting of: Fiber light cable Ø 5 mm, TL 2.3 m (80665023), projector-side adapter (8095.07), and endoscope-side adapter (809509)	Ø 5.0 mm, 2.3 m long	<b>806650231</b>
Fusion <b>Fiber light cable bndl</b> consisting of: Fiber light cable Ø 5 mm, TL 2.3 m (80655023), projector-side adapter (8095.07), and endoscope-side adapter (809509)	Ø 5.0 mm, 2.3 m long	<b>806550231</b>
Sealing cap, sulfur yellow, cap. 1.3 mm		<b>8934201</b>



11123 || Subject to modifications. Please note that some products may not be available in all countries. Please always take note of the information that is provided with the product. For more detailed information, please consult with your contact partner or directly with Richard Wolf GmbH.



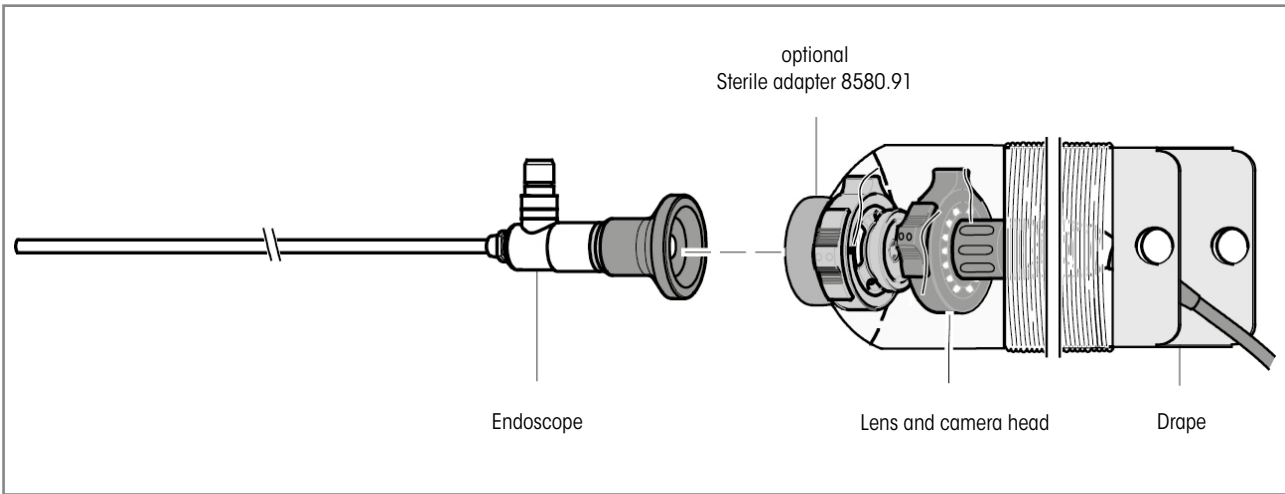

LAPAROSCOPES  
ACCESSORIES

			Product no.
	<b>Sterile adapter</b>	immersible and autoclavable for changing telescopes	<b>8580.91</b>



## TROCAR SLEEVES 2.2 / 2.5 MM



				Tip triangular	
				Trocar tip triangular Size 2.2 mm	
<b>Plastic sheath tube with thread</b>	<b>WL</b>	<b>Capacity</b>	<b>Product no.</b>	WL 82 mm	
<b>Trocar sleeve capacity 2.2 mm WL 60 mm with universal sealing valve</b>	 60 mm	2.2 mm	<b>8309.072</b>	<b>8309.121</b>	

Trocar sleeve with insufflation connector						Tip triangular	
Stainless steel sheath tube, smooth		<b>WL</b>	<b>Capacity</b>	<b>Product no.</b>	WL 82 mm		
<b>Trocar sleeve capacity 2.5 mm WL 95 mm</b>	 95 mm	2.5 mm	<b>8309.014</b>	<b>8309.121</b>			
				WL 119 mm			
<b>Trocar sleeve capacity 2.5 mm WL 95 mm</b>	 95 mm	2.5 mm	<b>8309.014</b>	<b>8309.123</b>			

<b>Accessories</b>	<b>Product no.</b>
<b>Rubber cap capacity 0.8 mm (PACK= 10 PCS) red</b>	<b>88.01</b>

# TROCAR SLEEVES 3.5 MM

## WITH INSUFFLATION STOPCOCK









<b>RIWO-ART trocar sleeves</b> with magnetic ball valve with insufflation stopcock						<b>Tip tapered/blunt</b> 	<b>Tip triangular</b> 
				<b>Trocar tip blunt</b> Size 3.5 mm	<b>Trocar tip triangular</b> Size 3.5 mm		
<b>Stainless steel sheath tube, smooth</b>		WL	Capacity	<b>Product no.</b>	WL 169 mm	WL 169 mm	
<b>Trocar sleeve straight</b> capacity 3.5 mm WL 100 mm		100 mm	3.5 mm	<b>8903.014</b>	<b>8903.103</b>	<b>8903.123</b>	
<b>Plastic sheath tube with thread</b>							
<b>Trocar sleeve straight</b> capacity 3.5 mm WL 100 mm		100 mm	3.5 mm	<b>8903.034</b>	<b>8903.103</b>	<b>8903.123</b>	
					WL 129 mm	WL 129 mm	
<b>Trocar sleeve slanted</b> capacity 3.5 mm WL 60 mm		60 mm	3.5 mm	<b>8903.072</b>	<b>8903.101</b>	<b>8903.121</b>	

Accessories	Product no.
Spare ball capacity 5.5 mm	<b>8921.901</b>
Spare O rings capacity 3.5 mm (PACK= 10 PCS), capacity Ø 3.5–5.5 mm	<b>8921.951</b>
Sealing cap capacity 2.4–3.4 mm (PACK= 10 PCS) red	<b>89.01</b>
Stopcock insert bndl cap. 3.0 mm (PACK= 5 PCS)	<b>896.0002</b>

<b>Trocar sleeve</b> with membrane valve						<b>Tip tapered/blunt</b> 
				<b>Trocar tip blunt</b> Size 3.5 mm		
<b>Plastic sheath tube with distal screw anchor</b>		WL	Capacity	<b>Product no.</b>	WL 169 mm	
<b>Trocar sleeve straight</b> capacity 3.5 mm WL 40 mm		40 mm	3.5 mm	<b>8929.223</b>	<b>8903.103</b>	









III23 || Subject to modifications. Please note that some products may not be available in all countries. Please always take note of the information that is provided with the product. For more detailed information, please consult with your contact partner or directly with Richard Wolf GmbH.

## TROCAR SLEEVES 5.5 MM

<b>RIWO-ART trocar sleeves</b> with magnetic ball valve with insufflation stopcock 				Tip tapered/blunt	Tip tapered/ pointed	Tip triangular
				Trocar tip blunt Size 5.5 mm	Trocar tip pointed Size 5.5 mm	Trocar tip triangular Size 5.5 mm
<b>Stainless steel sheath tube</b>	<b>WL</b>	<b>Capacity</b>	<b>Product no.</b>	<b>WL 169 mm</b>	<b>WL 169 mm</b>	<b>WL 169 mm</b>
<b>Trocar sleeve straight capacity 5.5 mm</b> WL 100 mm smooth 	100 mm	5.5 mm	<b>8921.014</b>	<b>8921.103</b>	<b>8921.113</b>	<b>8921.123</b>
<b>Trocar sleeve slanted capacity 5.5 mm</b> WL 100 mm smooth 	100 mm	5.5 mm	<b>8921.013</b>	<b>8921.103</b>	<b>8921.113</b>	<b>8921.123</b>
<b>Trocar sleeve straight capacity 5.5 mm</b> WL 100 mm with thread 	100 mm	5.5 mm	<b>8921.024</b>	<b>8921.103</b>	<b>8921.113</b>	<b>8921.123</b>
<b>Trocar sleeve slanted capacity 5.5 mm</b> WL 100 mm with thread 	100 mm	5.5 mm	<b>8921.023</b>	<b>8921.103</b>	<b>8921.113</b>	<b>8921.123</b>
Plastic tube <b>Trocar sleeve straight capacity 5.5 mm</b> WL 100 mm with thread 	100 mm	5.5 mm	<b>8921.034</b>	<b>8921.103</b>	<b>8921.113</b>	<b>8921.123</b>
				<b>WL 219 mm</b>	<b>WL 219 mm</b>	<b>WL 219 mm</b>
<b>Trocar sleeve straight capacity 5.5 mm</b> WL 150 mm smooth 	150 mm	5.5 mm	<b>8921.016</b>	<b>8921.105</b>	<b>8921.115</b>	<b>8921.125</b>
<b>Trocar sleeve straight capacity 5.5 mm</b> WL 150 mm with thread 	150 mm	5.5 mm	<b>8921.026</b>	<b>8921.105</b>	<b>8921.115</b>	<b>8921.125</b>

<b>Accessories</b>	<b>Product no.</b>
<b>Spare ball capacity 5.5 mm</b>	<b>8921.901</b>
<b>Spare O rings capacity 3.5 mm (PACK= 10 PCS), capacity Ø 3.5–5.5 mm</b>	<b>8921.951</b>
<b>Sealing cap capacity 3.4–5.1 mm (PACK= 10 PCS) blue</b>	<b>89.02</b>
<b>Stopcock insert bndl cap. 3.0 mm (PACK= 5 PCS)</b>	<b>896.0002</b>

# TROCAR SLEEVES 5.5 MM





RIWO-ART trocar sleeves with magnetic ball valve 				Tip tapered/blunt	Tip tapered/ pointed	Tip triangular	
				Trocar tip blunt Size 5.5 mm	Trocar tip pointed Size 5.5 mm	Trocar tip triangular Size 5.5 mm	
Stainless steel sheath tube		WL	Capacity	Product no.	WL 129 mm	WL 129 mm	WL 129 mm
Trocar sleeve straight capacity 5.5 mm WL 60 mm smooth 		60 mm	5.5 mm	8921.052	8921.101	8921.111	8921.121
Trocar sleeve slanted capacity 5.5 mm WL 60 mm smooth 		60 mm	5.5 mm	8921.051	8921.101	8921.111	8921.121
Trocar sleeve straight capacity 5.5 mm WL 60 mm with thread 		60 mm	5.5 mm	8921.062	8921.101	8921.111	8921.121
Trocar sleeve slanted capacity 5.5 mm WL 60 mm with thread 		60 mm	5.5 mm	8921.061	8921.101	8921.111	8921.121
Plastic tube Trocar sleeve straight capacity 5.5 mm WL 60 mm with thread 		60 mm	5.5 mm	8921.072	8921.101	8921.111	8921.121
					WL 169 mm	WL 169 mm	WL 169 mm
Trocar sleeve straight capacity 5.5 mm WL 100 mm smooth 		100 mm	5.5 mm	8921.054	8921.103	8921.113	8921.123
Trocar sleeve straight capacity 5.5 mm WL 100 mm with thread 		100 mm	5.5 mm	8921.053	8921.103	8921.113	8921.123

Accessories	Product no.
Spare ball capacity 5.5 mm	8921.901
Spare O rings capacity 3.5 mm (PACK= 10 PCS), capacity Ø 3.5–5.5 mm	8921.951
Sealing cap capacity 3.4–5.1 mm (PACK= 10 PCS) blue	89.02

# TROTEC

## TROCAR WITH AUTOMATIC PROTECTIVE FUNCTION

### FOR TROCAR SLEEVES 5.5 MM

Trocar consisting of:		Product no.	for RIWO-ART trocar sleeve with WL 100 mm, Ø 5,5 mm
Sheath with trocar tip Size 5.5 mm WL 181 mm	<b>Tapered tip</b> 	8921.132	
Sheath with trocar tip Size 5.5 mm WL 181 mm	<b>Two-sided tip</b> 	8921.134	
<b>Spring-loaded protective rod</b> WL 184 mm		8923.135	

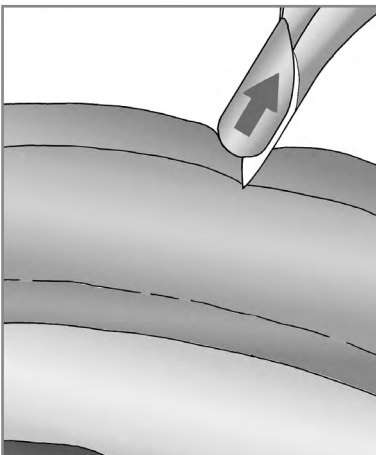

Protective tip automatically pushes back into the cannula through contact with the abdominal wall

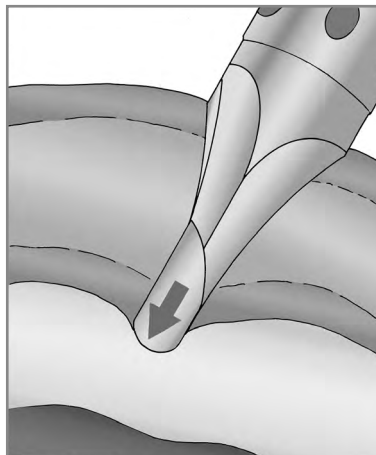

The protective tip advances into the free abdomen immediately after penetration of the peritoneum

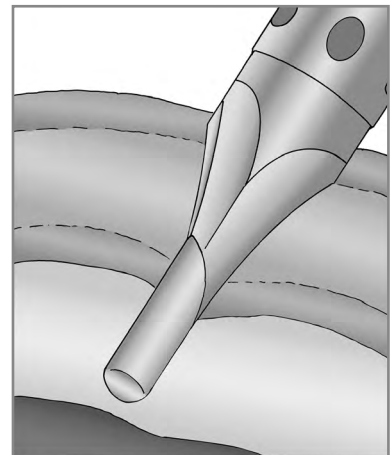





The atraumatic protective tip in a far distal position prevents perforation of organs and vessels



# TROCAR SLEEVE 5.5 MM/5.8 MM

PLASTIC WITH SEALING MEMBRANE

TROCAR SLEEVES

3

 <p><b>AUTOCLAVE</b> <b>134° C / 273° F</b></p>					Tip tapered/blunt	Tip tapered/pointed	Tip triangular
							
					Trocar tip blunt Size 5.5 mm	Trocar tip pointed Size 5.5 mm	Trocar tip triangular Size 5.5 mm
Flexible plastic sheath tube with thread	WL	Capacity	with stopcock	Product no.	WL 104 mm	WL 104 mm	WL 104 mm
Trocar sleeve straight capacity 5.5 mm WL 62 mm with membrane valve	62 mm	5.5 mm	●	8919.333	8919.3311	8919.3312	8919.3313
				8919.331			
					WL 144 mm	WL 144 mm	WL 144 mm
Trocar sleeve straight capacity 5.5 mm WL 102 mm with membrane valve	102 mm	5.5 mm	●	8919.353	8919.3511	8919.3512	8919.3513
				8919.351			

for curved instruments				Tip tapered/blunt	Tip tapered/pointed	Tip triangular	Tip tapered/blunt
 <p><b>AUTOCLAVE</b> <b>134° C / 273° F</b></p>							
				Trocar tip blunt Size 5.5 mm	Trocar tip pointed Size 5.5 mm	Trocar tip triangular Size 5.5 mm	Trocar tip blunt Size 5.5 mm
Flexible plastic sheath tube with thread	WL	Capacity	Product no.	WL 80 mm	WL 80 mm	WL 80 mm	WL 80 mm
Trocar sleeve straight capacity 5.8 mm WL 62 mm with membrane valve	62 mm	5.8 mm	8905.331	8905.3311	8905.3312	8905.3313	8905.3315
				WL 120 mm	WL 120 mm	WL 120 mm	WL 120 mm
Trocar sleeve straight capacity 5.8 mm WL 102 mm with membrane valve	102 mm	5.8 mm	8905.3515	8905.3511	8905.3512	8905.3513	8905.3515

Accessories	Product no.
Sealing membrane Ø 17 mm, yellow (PACK= 10 PCS)	89.103
Stopcock insert bndl cap 3.0 mm (PACK= 5 PCS)	896.0002

11123 || Subject to modifications. Please note that some products may not be available in all countries. Please always take note of the information that is provided with the product. For more detailed information, please consult with your contact partner or directly with Richard Wolf GmbH.



# TROCAR SLEEVE 5.7 MM/7 MM/10 MM/12.5 MM









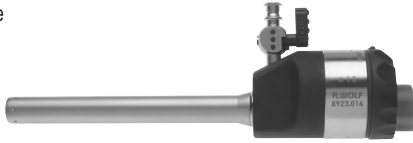

## FLEXIBLE PLASTIC SHEATH TUBE

				Tip tapered/blunt
				Trocar tip blunt
Flexible plastic sheath tube with thread	WL	Capacity	Product no.	Size 5.5 mm/WL 83 mm
Trocar sleeve straight capacity 5.7 mm WL 60 mm with rubber cap	60 mm	5.7 mm	8906.051	8906.151

				Tip tapered/blunt
				Trocar tip blunt
Ribbed flexible plastic sheath tube	WL	Capacity	Product no.	Size 7.3 mm/TL 108 mm
Trocar sleeve flexible capacity 7 mm WL 74 mm with universal seal	74 mm	7 mm	8906.001	8913.11
				Size 10 mm/TL 85 mm
Trocar sleeve flexible capacity 10 mm WL 56 mm with universal seal	56 mm	10 mm	8906.011	8906.111
				Size 12.5 mm/TL 86 mm
Trocar sleeve flexible capacity 12.5 mm WL 57 mm with universal seal	57 mm	12.5 mm	8906.031	8906.131





# TROCAR SLEEVE 10 MM

## WITH INSUFFLATION STOPCOCK

RIWO-ART trocar sleeves with magnetic ball valve 					Tip tapered/blunt	Tip tapered/pointed	Tip triangular
					 Trocar tip blunt Size 10 mm	 Trocar tip pointed Size 10 mm	 Trocar tip triangular Size 10 mm
Stainless steel sheath tube		WL	Capacity	Product no.	WL 164 mm	WL 164 mm	WL 164 mm
Trocar sleeve straight capacity 10 mm WL 100 mm		100 mm	10 mm	<b>8923.014</b>	<b>8923.103</b>	<b>8923.113</b>	<b>8923.123</b>
Trocar sleeve slanted capacity 10 mm WL 100 mm		100 mm	10 mm	<b>8923.013</b>	<b>8923.103</b>	<b>8923.113</b>	<b>8923.123</b>
Trocar sleeve straight capacity 10 mm WL 100 mm with thread		100 mm	10 mm	<b>8923.024</b>	<b>8923.103</b>	<b>8923.113</b>	<b>8923.123</b>
Trocar sleeve slanted capacity 10 mm WL 100 mm with thread		100 mm	10 mm	<b>8923.023</b>	<b>8923.103</b>	<b>8923.113</b>	<b>8923.123</b>
					WL 214 mm	WL 214 mm	WL 214 mm
Trocar sleeve straight capacity 10 mm WL 150 mm		150 mm	10 mm	<b>8923.016</b>	-	<b>8923.115</b>	<b>8923.125</b>
Trocar sleeve straight capacity 10 mm WL 150 mm with thread		150 mm	10 mm	<b>8923.026</b>	-	<b>8923.115</b>	<b>8923.125</b>

Accessories	Product no.
Spare ball capacity 7 mm	<b>8923901</b>
Spare O rings capacity 7 mm (PACK= 10 PCS), capacity Ø 7–12.5 mm	<b>8923951</b>
Sealing cap capacity 9.5–10.1 mm (PACK= 10 PCS) red	<b>8908</b>
Stopcock insert bndl cap. 3.0 mm (PACK= 5 PCS)	<b>896.0002</b>

**TROTEC**  
**TROCAR WITH AUTOMATIC PROTECTIVE FUNCTION**  
 FOR TROCAR SLEEVES 10 MM

<b>Trocar consisting of:</b>		<b>Product no.</b>	<b>for RIWO-ART trocar sleeve with WL 100 mm, ø 10 mm</b>
<b>Sheath with trocar tip Size 10 mm WL 181 mm</b>	<b>Tapered tip</b> 	<b>8923.132</b>	
<b>Sheath with trocar tip Size 10 mm WL 181 mm</b>	<b>Two-sided tip</b> 	<b>8923.134</b>	
<b>Spring-loaded protective rod WL 184 mm</b>		<b>8923.135</b>	

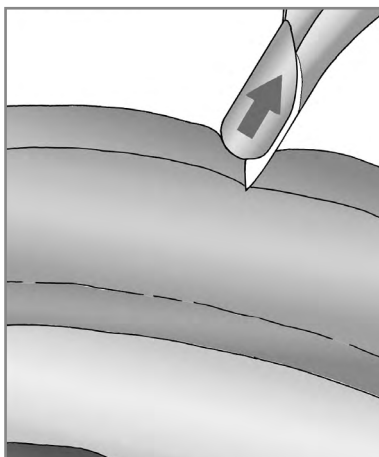

Protective tip automatically pushes back into the cannula through contact with the abdominal wall

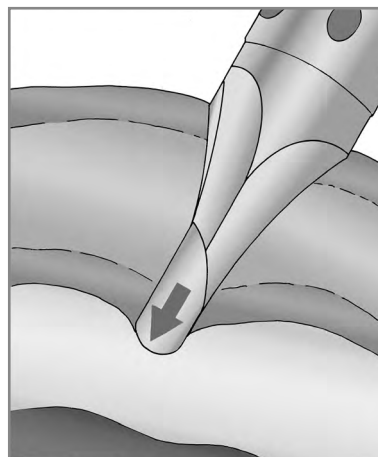

The protective tip advances into the free abdomen immediately after penetration of the peritoneum

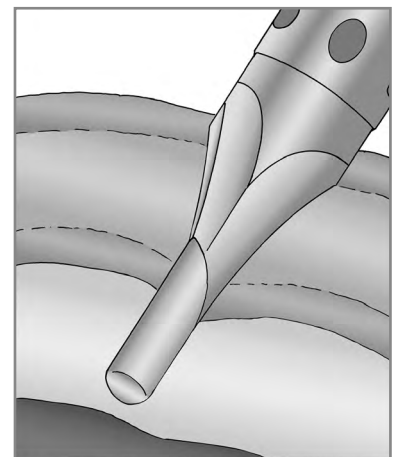





The atraumatic protective tip in a far distal position prevents perforation of organs and vessels

# HIGH FLOW TROCAR SLEEVE 10 MM

## WITH CONNECTOR FOR HIGH FLOW INSUFFLATION TUBE

TROCAR SLEEVES

3







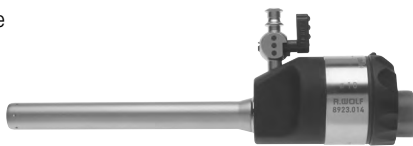

RIWO-ART trocar sleeves with magnetic ball valve 				Tip tapered/blunt	Tip tapered/pointed	Tip triangular		
								
				Trocar tip blunt Size 10 mm	Trocar tip pointed Size 10 mm	Trocar tip triangular Size 10 mm		
Stainless steel sheath tube		WL	Capacity	Product no.	WL 164 mm	WL 164 mm	WL 164 mm	
Trocar sleeve straight capacity 10 mm WL 100 mm			100 mm	10 mm	<b>8923.042</b>	<b>8923.103</b>	<b>8923.113</b>	<b>8923.123</b>
for this:						Product no.		
Reducing adapter (PACK= 5 PCS)			for reduction from Ø 7 mm, Ø 10 mm, and Ø 12.5 mm to Ø 5.5 mm			<b>8923802</b>		

Accessories	Product no.
Spare ball capacity 7 mm	<b>8923901</b>
Spare O rings capacity 7 mm (PACK= 10 PCS), capacity Ø 7–12.5 mm	<b>8923951</b>
Sealing cap capacity 9.5–10.1 mm (PACK= 10 PCS) red	<b>8908</b>

III23 || Subject to modifications. Please note that some products may not be available in all countries. Please always take note of the information that is provided with the product. For more detailed information, please consult with your contact partner or directly with Richard Wolf GmbH.

# TROCAR SLEEVE 12.5 MM

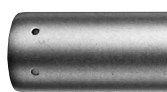
## WITH INSUFFLATION STOPCOCK





RIWO-ART trocar sleeves with magnetic ball valve 				Tip tapered/blunt	Tip tapered/pointed	Tip triangular		
								
				Trocar tip blunt Size 12.7 mm	Trocar tip pointed Size 12.7 mm	Trocar tip triangular Size 12.7 mm		
Stainless steel sheath tube		WL	Capacity	Product no.	WL 164 mm	WL 164 mm	WL 164 mm	
Trocar sleeve straight capacity 12.5 mm WL 100 mm			100 mm	12.5 mm	<b>8924.014</b>	<b>8924.103</b>	<b>8924.113</b>	<b>8924.123</b>
Trocar sleeve slanted capacity 12.5 mm WL 100 mm			100 mm	12.5 mm	<b>8924.013</b>	<b>8924.103</b>	<b>8924.113</b>	<b>8924.123</b>
					WL 214 mm	WL 214 mm	WL 214 mm	
Trocar sleeve straight capacity 12.5 mm WL 150 mm with thread			150 mm	12.5 mm	<b>8924.026</b>	-	<b>8924.115</b>	<b>8924.125</b>
Trocar sleeve straight capacity 12.5 mm WL 150 mm			150 mm	12.5 mm	<b>8924.016</b>	-	<b>8924.115</b>	<b>8924.125</b>
for this:								
Reducing adapter (PACK= 5 PCS)				for reduction from Ø 10 mm to Ø 5.5 mm and Ø 12.5 mm to Ø 5.5 mm			<b>8923.802</b>	
				for reduction from Ø 12.5 mm to Ø 10 mm			<b>8924.802</b>	

Accessories	Product no.
Spare ball capacity 7 mm	<b>8923.901</b>
Spare O rings capacity 7 mm (PACK= 10 PCS), capacity Ø 7–12.5 mm	<b>8923.951</b>
Sealing cap capacity 9.5–10.1 mm (PACK= 10 PCS) red	<b>89.08</b>
Stopcock insert bndl cap. 3.0 mm (PACK= 5 PCS)	<b>896.0002</b>

**TROTEC**  
**TROCAR WITH AUTOMATIC PROTECTIVE FUNCTION**  
 FOR TROCAR SLEEVES 12.5 MM

TROCAR SLEEVES

3

			
Trocar consisting of:		Product no.	for RIWO-ART trocar sleeve with WL 100 mm, Ø 12,5 mm
Sheath with trocar tip Size 12.5 mm WL 181 mm	Two-sided tip 	8924.134	
Spring-loaded protective rod WL 184 mm		8923.135	

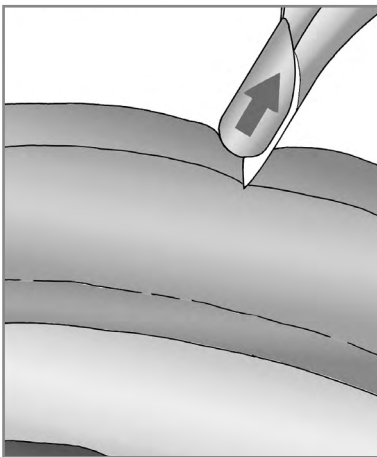

Protective tip automatically pushes back into the cannula through contact with the abdominal wall

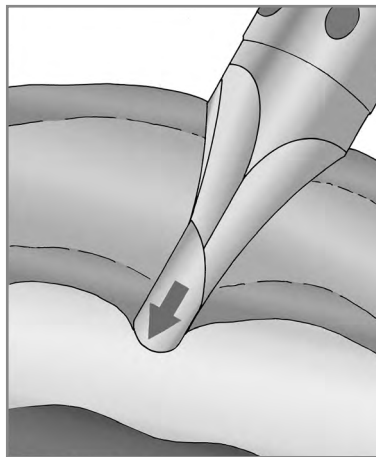

The protective tip advances into the free abdomen immediately after penetration of the peritoneum

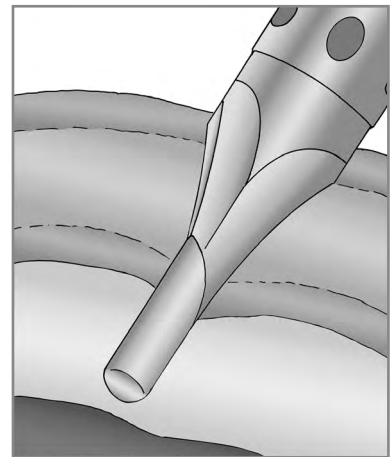

The atraumatic protective tip in a far distal position prevents perforation of organs and vessels

III23 || Subject to modifications. Please note that some products may not be available in all countries. Please always take note of the information that is provided with the product. For more detailed information, please consult with your contact partner or directly with Richard Wolf GmbH.

# DILATATION AND EXTRACTION INSTRUMENTS

5.5 TO 10/10 TO 12.5 MM

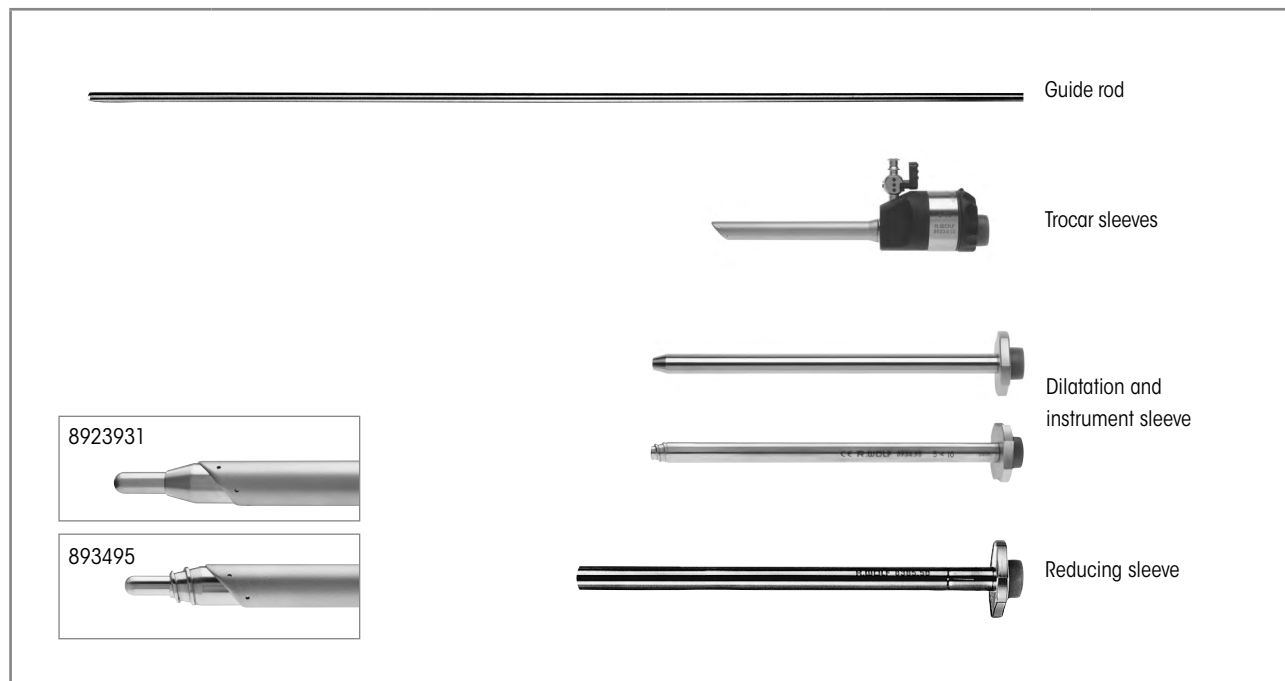

Incision widening	Guide rod	Trocar sleeve slanted	Dilatation sleeve	Instrument sleeve	Reducing sleeve
3.5 mm < 5.5 mm	-	<b>8921.013</b> capacity 5.5 mm WL 100 mm			<b>8383.78</b> Size 5 mm L 155 mm
5.5 mm < 10 mm	<b>8923.921</b> 5.5 mm TL 500 mm	<b>8923.013</b> capacity 10 mm WL 100 mm	<b>8923.931</b> Size 10 mm WL 170 mm	<b>8385.50</b> 10 mm WL 170 mm	
5.0 mm < 10 mm	<b>8934.951</b> 5 mm TL 500 mm		<b>8934.95</b> Size 10 mm WL 172 mm		
10 mm < 12.5 mm		<b>8924.013</b> capacity 12.5 mm WL 100 mm			<b>8941.901</b> 12 mm WL 180 mm
5.5 mm < 12.5 mm					<b>8941.951</b> 12 mm WL 180 mm
10 mm < 15 mm	<b>8943.901</b> 10 mm TL 500 mm				

11123 || Subject to modifications. Please note that some products may not be available in all countries. Please always take note of the information that is provided with the product. For more detailed information, please consult with your contact partner or directly with Richard Wolf GmbH.

## REDUCING SLEEVES FOR RIWO-ART TROCAR SLEEVES

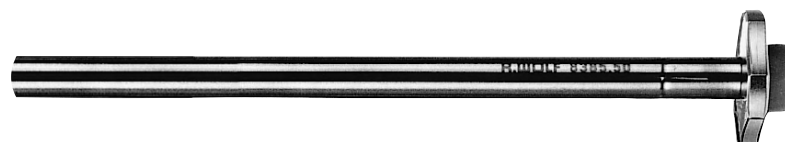



Stainless steel sheath tube	Outer Ø	WL	for instruments	Product no.
<b>Reducing sleeve</b> Size 5 mm WL 155 mm	5 mm	155 mm	3.5 mm	<b>8383.78</b>
<b>Instrument sleeve</b> 10 mm WL 170 mm	10 mm	170 mm	5.5 mm	<b>8385.50</b>
<b>Reducing sleeve</b> 12 mm WL 180 mm	12 mm	180 mm	10 mm	<b>8941.901</b>
<b>Reducing sleeve</b> 12 mm WL 180 mm	12 mm	180 mm	5.5 mm	<b>8941.951</b>
for this:				
<b>Reducing adapter</b> (PACK= 5 PCS)		for reduction from Ø 7 mm, Ø 10 mm, and Ø 12.5 mm to Ø 5.5 mm		<b>8923802</b>
		for reduction from Ø 12.5 mm to Ø 10 mm		<b>8924802</b>

Accessories	Product no.
<b>Sealing cap capacity 3.4–5.1 mm (PACK= 10 PCS) blue</b>	<b>89.02</b>
<b>Sealing cap capacity 9.5–10.1 mm (PACK= 10 PCS) red</b>	<b>8908</b>



# VERES CANNULAS

## FOR CREATION OF THE PNEUMOPERITONEUM

				
		Outer Ø	WL	Product no.
	VERES cannula Ø 2.1 mm WL 150 mm	<b>2.1 mm</b>	150 mm	<b>8302.15</b>
	VERES cannula Ø 2.1 mm WL 152 mm (standard length)		120 mm	<b>8302.12</b>
	VERES cannula Ø 2.1 mm WL 80 mm		80 mm	<b>8302.08</b>
<b>for this:</b>				
Tube with Luer-Lock connector				<b>886.00</b>

Accessories	Product no.
Stopcock insert bndl cap. 3.0 mm (PACK= 5 PCS)	<b>896.0002</b>

11123 || Subject to modifications. Please note that some products may not be available in all countries. Please always take note of the information that is provided with the product. For more detailed information, please consult with your contact partner or directly with Richard Wolf GmbH.

# ERAGON<sup>modular</sup>

## THE LAPAROSCOPIC TOOLBOX

### The toolbox principle

**ERAGONmodular** allows the surgeon to create their ideal laparoscopic set. Ergonomic handles, diameters relevant to all medical practice, useful working lengths, and a range of jaw sections can be combined as necessary. This universal compatibility also ensures that individual trays can comprise fewer instruments – for more efficiency and one way of cutting costs

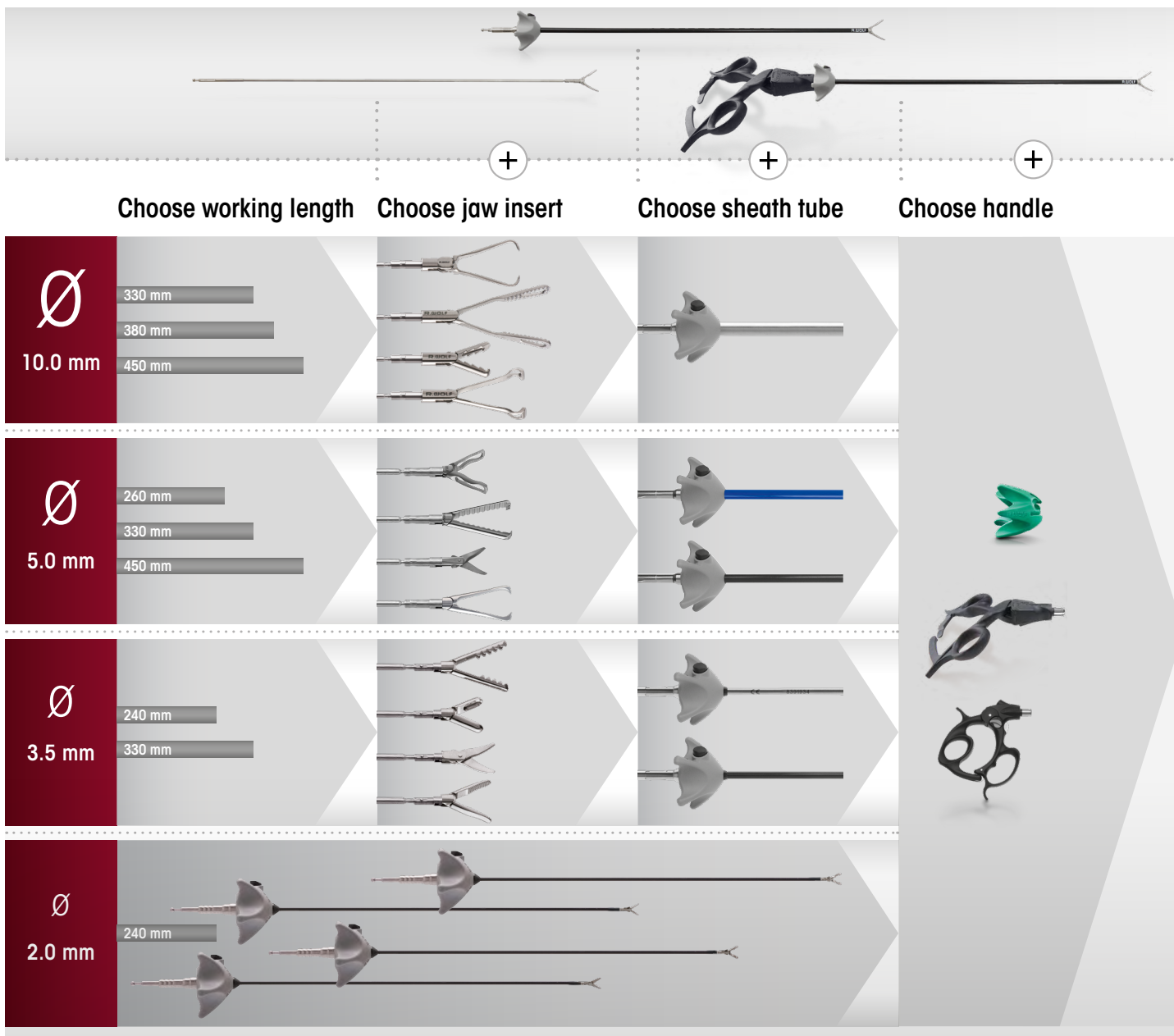

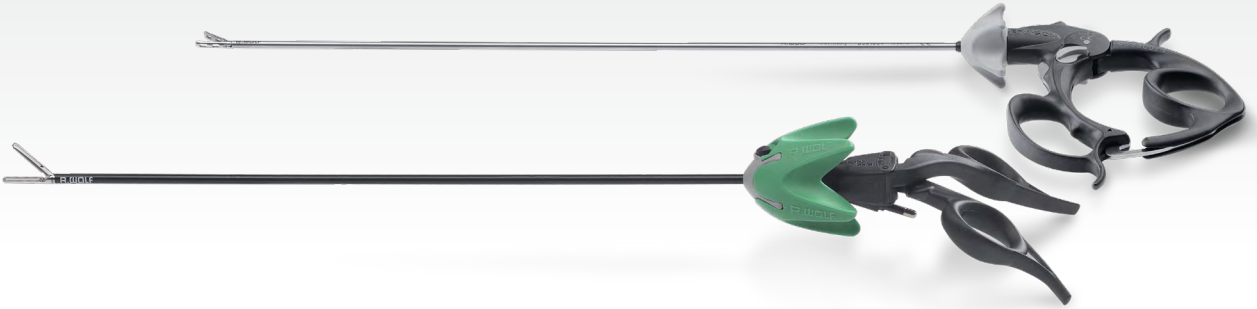



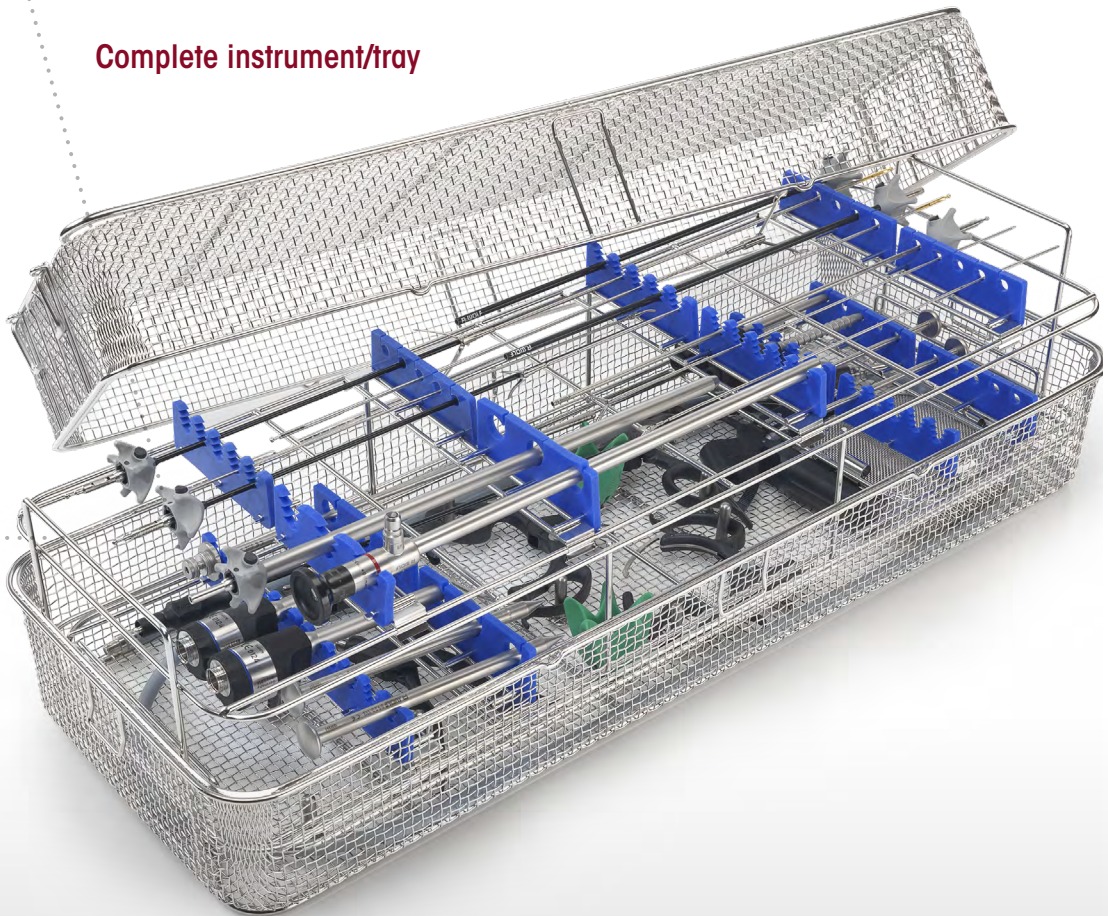





**Complete instrument/tray**







**ERAGON** *modular*  
*micro*  
Ø 2 MM, INSULATED

		Handle, axial	
<b>ERAGON</b> <i>axial</i>			
All jaw inserts and sheath tubes can also be combined with <b>ERAGON</b> axial		without lock, with HF connector	without lock, with HF connector
<b>Rotatable knob</b>	<b>Product no.</b>	83930083	83930084
	8988	•	•

Jaw insert			Sheath tube, Ø 2.0 mm, insulated	Handle, pistol-shaped	Complete instrument • Jaw insert with sheath tube • Handle
					
			WL 240 mm	without lock, with HF, mono	
	<b>JL*</b>	<b>Product no.</b>		83930073	<b>Product no.</b>
	7 mm	8388200	•	•	<b>83882007</b>
Scissors mono Ø 2 mm bndl straight, double-action					
	7 mm	8388201	•	•	<b>83882017</b>
Dissector forceps mono Ø 2 mm bndl straight, double-action					
	7 mm	8388202	•	•	<b>83882027</b>
Atraumatic grasping forceps mono Ø 2 mm bndl fenestrated, double-action					

\* JL = jaw length when jaw section closed (approximate measurements)  
HF connection cable: see sheet BDE116/117

**ERAGON** *modular*  
*micro*  
Ø 2 MM, INSULATED

Jaw insert		Sheath tube, Ø 2.0 mm, insulated		Handle, pistol-shaped	Complete instrument • Jaw insert with sheath tube • Handle
					
		WL 240 mm		with lock, with HF, mono	
	JL*	Product no.		83930074	Product no.
 Grasping forceps mono Ø 2 mm bndl  double-action	7 mm	8388203	•	•	<b>83882037</b>



\* JL = jaw length when jaw section closed (approximate measurements)  
HF connection cable: see sheet BDE116/117







Accessories for manual and machine reprocessing		Product no.
	Irrigation adapter Ø 9 mm, length 64 mm	<b>163502</b>

11123 || Subject to modifications. Please note that some products may not be available in all countries. Please always take note of the information that is provided with the product. For more detailed information, please consult with your contact partner or directly with Richard Wolf GmbH.

**ERAGON** modular mini

Ø 3.5 MM, INSULATED

		Handle, axial	
<b>ERAGON</b> axial			
All jaw inserts and sheath tubes can also be combined with ERAGONaxial		without lock, with HF connector	without lock, with HF connector
<b>Rotatable knob</b>	<b>Product no.</b>	83930083	83930084
	8988	•	•









Jaw insert		Sheath tube, Ø 3.5 mm, insulated		Handle, pistol-shaped	Complete instrument	
					<ul style="list-style-type: none"> <li>• Jaw insert with sheath tube</li> <li>• Handle</li> </ul>	
		WL 240 mm	WL 330 mm	with lock, with HF, mono		
	<b>JL*</b>	<b>Product no.</b>	8390933	8391933	83930074	<b>Product no.</b>
	15 mm	8390207	•	•	•	<b>83902077</b>
curved to the left, double-action		8391207	•	•	•	<b>83912077</b>
	18 mm	8390221	•	•	•	<b>83902217</b>
long, fine tip, double-action		8391221	•	•	•	<b>83912217</b>
	14 mm	8390222	•	•	•	<b>83902227</b>
short, fine tip, double-action		8391222	•	•	•	<b>83912227</b>
	14 mm	8390223	•	•	•	<b>83902237</b>
angled, double-action		8391223	•	•	•	<b>83912237</b>

\* JL = jaw length when jaw section closed (approximate measurements)

HF connection cable: see sheet BDE116/117

**ERAGON modular mini**

Ø 3.5 MM, INSULATED

Jaw insert			Sheath tube, Ø 3.5 mm, insulated		Handle, pistol-shaped		Complete instrument • Jaw insert with sheath tube • Handle
							
							WL 240 mm
	JL*	Product no.	8390933	8391933	83930073	83930074	Product no.
 Metzenbaum scissors mono Ø 3.5 mm bndl 16 mm double-action		8390215	•		•		83902157
		8391215		•	•		83912157
 Metzenbaum scissors mono Ø 3.5 mm bndl 14 mm fine-toothed, curved, double-action		8390224	•		•		83902247
		8391224		•	•		83912247
 Hook scissors mono Ø 3.5 mm bndl 8 mm single-action		8390227	•		•		83902277
		8391227		•	•		83912277
 Double spoon forceps mono Ø 3.5 mm bndl 12 mm		8390216	•			•	83902167
		8391216		•		•	83912167
 Friedel punch mono Ø 3.5 mm bndl 10 mm		8390217	•			•	83902177
		8391217		•		•	83912177



\* JL = jaw length when jaw section closed (approximate measurements)







HF connection cable: see sheet BDE116/117

Accessories for manual and machine reprocessing		Product no.
	Irrigation adapter Ø 9 mm, length 64 mm	163502

11123 || Subject to modifications. Please note that some products may not be available in all countries. Please always take note of the information that is provided with the product. For more detailed information, please consult with your contact partner or directly with Richard Wolf GmbH.

**ERAGON** modular mini  
Ø 3.5 MM, UNINSULATED

		Handle, axial	
<b>ERAGON</b> axial			
All jaw inserts and sheath tubes can also be combined with <b>ERAGON</b> axial		with lock, without HF connector	with lock, without HF connector, not rotatable
Rotatable knob	Product no.	83930082	83930085
	8988	.	.

Jaw insert		Sheath tube, Ø 3.5 mm, insulated		Handle, pistol-shaped	Complete instrument	
					<ul style="list-style-type: none"> <li>• Jaw insert with sheath tube</li> <li>• Handle</li> </ul>	
		WL 240 mm	WL 330 mm	with lock, without HF		
	JL*	Product no.	8390933	8391933	83930072	Product no.
	14 mm	8390208	.	.	.	<b>83902087</b>
fenestrated, double-action		8391208	.	.	.	<b>83912087</b>
	17 mm	8390218	.	.	.	<b>83902187</b>
fenestrated, single-action		8391218	.	.	.	<b>83912187</b>
	17 mm	8390225	.	.	.	<b>83902257</b>
double fenestrated, curved, single-action		8391225	.	.	.	<b>83912257</b>
	19 mm	8390226	.	.	.	<b>83902267</b>
fenestrated, double-action		8391226	.	.	.	<b>83912267</b>







\* JL = jaw length when jaw section closed (approximate measurements)

HF connection cable: see sheet BDE116/117

|||23 || Subject to modifications. Please note that some products may not be available in all countries. Please always take note of the information that is provided with the product. For more detailed information, please consult with your contact partner or directly with Richard Wolf GmbH.



**ERAGON** modular  
mini  
Ø 3.5 MM, UNINSULATED

Jaw insert			Sheath tube, Ø 3.5 mm, insulated		Handle, pistol-shaped	Complete instrument • Jaw insert with sheath tube • Handle
			WL 240 mm	WL 330 mm	 with lock, without HF	
			Product no.	8390933		8391933
 Grasping forceps Ø 3.5 mm bndl 13 mm fenestrated, double-action	JL*	8390219	•		•	83902197
		8391219		•	•	83912197
 Grasping forceps Ø 3.5 mm bndl 17 mm fenestrated, single-action	JL*	8390220	•		•	83902207
		8391220		•	•	83912207
 Universal grasping forceps Ø 3.5 mm bndl 14 mm double-action	JL*	8390209	•		•	83902097
		8391209		•	•	83912097
 Babcock forceps Ø 3.5 mm bndl 19 mm double-action	JL*	8390210	•		•	83902107
		8391210		•	•	83912107







\* JL = jaw length when jaw section closed (approximate measurements)  
HF connection cable: see sheet BDE116/117







Accessories for manual and machine reprocessing		Product no.
	Irrigation adapter Ø 9 mm, length 64 mm	163503

**ERAGON** modular  
Ø 5.0 MM, INSULATED

ERAGONMODULAR

4

		Handle, axial			
 All jaw inserts and sheath tubes can also be combined with <b>ERAGONaxial</b>					
		with lock	without lock, with HF connector	without lock, with HF connector	with lock, not rotatable
Rotatable knob	Product no.	83930082	83930083	83930084	83930085
	8988	•	•	•	







Jaw insert		Sheath tube, Ø 5.0 mm, insulated		Handle, pistol-shaped	Complete instrument	
					<ul style="list-style-type: none"> <li>• Jaw insert with sheath tube</li> <li>• Handle</li> </ul>	
	JL*	Product no.	SL 330 mm	SL 450 mm	with lock, with HF, mono	Product no.
	21 mm	8393.281	•		•	<b>83932817</b>
curved, with fine cross toothing, double-action		8394.281		•		•
	22 mm	8393.283	•		•	<b>83932837</b>
angled, fine, pyramid-shaped toothing, double-action						
	21 mm	8393.185	•		•	<b>83931857</b>
fenestrated, with fine cross toothing, 15 mm long, single-action						
	26 mm	8393.184	•		•	<b>83931847</b>
fenestrated, with fine cross toothing, 20 mm long, single-action		8394.184		•		•

\* JL = jaw length when jaw section closed (approximate measurements)  
 HF connection cable: see sheet BDE116/117

III23 || Subject to modifications. Please note that some products may not be available in all countries. Please always take note of the information that is provided with the product. For more detailed information, please consult with your contact partner or directly with Richard Wolf GmbH.

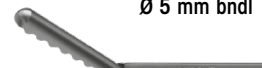
**ERAGON** modular

Ø 5.0 MM, INSULATED

Jaw insert			Sheath tube, Ø 5.0 mm, insulated			Handle, pistol-shaped			Complete instrument • Jaw insert with sheath tube • Handle
			SL 260 mm	SL 330 mm	SL 450 mm	with lock, without HF	without lock, with HF, mono	with lock, with HF, mono	
	JL*	Product no.	8392933	8393933	8394933	83930072	83930073	83930074	Product no.
 <b>Dolphin dissector forceps mono Ø 5 mm bndl</b> angled, with fine cross-toothing, with channel, narrow, 15 mm long, double-action	17 mm	8393.285		•			•		<b>83932857</b>
 <b>Dissector forceps mono Ø 5 mm bndl</b> fine pyramid-shaped toothing, narrow, 18 mm, double-action	23 mm	8393.289		•				•	<b>83932897</b>
 <b>Atraumatic grasping forceps Ø 5 mm bndl</b> Channel with wavy tooth edge, 20 mm, single-action	26 mm	8393.292		•			•		<b>83932925</b>
 <b>Atraumatic grasping forceps Ø 5 mm bndl</b> Channel with wavy tooth edge, 20 mm, double-action	26 mm	8393.293		•			•		<b>83932935</b>
		8394.293			•		•		<b>83942935</b>
 <b>Grasping forceps, mono Ø 5 mm bndl</b> fine, pyramid-shaped toothing, narrow double-action	19 mm	8393.288		•				•	<b>83932887</b>
 <b>Atraumatic grasping forceps mono Ø 5 mm bndl</b> fenestrated, with cross toothing, double-action	19 mm	8392.181	•					•	<b>83921817</b>
		8393.181		•				•	<b>83931817</b>
		8394.181			•			•	<b>83941817</b>

\* JL = jaw length when jaw section closed (approximate measurements)







HF connection cable: see sheet BDE116/117







11123 || Subject to modifications. Please note that some products may not be available in all countries. Please always take note of the information that is provided with the product. For more detailed information, please consult with your contact partner or directly with Richard Wolf GmbH.

**ERAGON** modular  
Ø 5.0 MM, INSULATED

ERAGONMODULAR

4

		Handle, axial			
 All jaw inserts and sheath tubes can also be combined with ERAGONaxial					
		with lock	without lock, with HF connector	without lock, with HF connector	with lock, not rotatable
Rotatable knob	Product no.	83930082	83930083	83930084	83930085
	8988	•	•	•	

Jaw insert		Sheath tube, Ø 5.0 mm, insulated		Handle, pistol-shaped		Complete instrument • Jaw insert with sheath tube • Handle	
							
	JL*	Product no.	SL 330 mm	SL 450 mm	with lock, without HF	without lock, with HF, mono	Product no.
 Atraumatic grasping forceps mono Ø 5 mm bndl 18 mm smooth, double-action	18 mm	8393.195	•			•	<b>83931957</b>
		8394.195		•			•
 Babcock forceps Ø 5 mm bndl 24 mm Gripping surface with fine cross tothing, double-action	24 mm	8393.186	•			•	<b>83931867</b>
		8393.187	•			•	
 Babcock forceps Ø 5 mm bndl 26 mm large distal gripping surface with fine cross tothing, double-action	26 mm	8394.187		•		•	<b>83941877</b>
		8393.190	•			•	
 Debakey forceps Ø 5 mm bndl 39 mm atraumatic clamp, double-action	39 mm	8393190	•			•	<b>83931907</b>









\* JL = jaw length when jaw section closed (approximate measurements)

HF connection cable: see sheet BDE50 1710

11123 || Subject to modifications. Please note that some products may not be available in all countries. Please always take note of the information that is provided with the product. For more detailed information, please consult with your contact partner or directly with Richard Wolf GmbH.

**ERAGON** modular







Ø 5.0 MM, INSULATED









Jaw insert			Sheath tube, Ø 5.0 mm, insulated		Handle, pistol-shaped		Complete instrument • Jaw insert with sheath tube • Handle
							
			SL 330 mm	SL 450 mm	with lock, without HF	with lock, with HF, mono	
	JL*	Product no.	8393933	8394933	83930072	83930074	Product no.
 <b>Debaque forceps</b> Ø 5 mm bndl atraumatic clamp, double-action	48 mm	8393191	•		•		<b>83931917</b>
 <b>Grasping forceps, mono</b> Ø 5 mm bndl with a row of teeth, double-action	17 mm	8393.485	•			•	<b>83934857</b>
 <b>Grasping forceps, mono</b> Ø 5 mm bndl with one tooth, fine cross toothing, narrow, double-action	19 mm	8393.486	•			•	<b>83934867</b>
 <b>Grasping forceps, mono</b> Ø 5 mm bndl with two teeth, fine cross toothing, single-action	17 mm	8393.487	•			•	<b>83934877</b>
 <b>Grasping forceps</b> Ø 5 mm bndl with two teeth wavy gripping surface, double-action	26 mm	8393.490	•		•		<b>83934907</b>
		8394.490			•	•	<b>83944907</b>
 <b>Petelin dissector forceps</b> mono Ø 5 mm bndl angled 30° to the left, with cross toothing, single-action	17 mm	8393.282	•			•	<b>83932827</b>

\* JL = jaw length when jaw section closed (approximate measurements)

HF connection cable: see sheet BDE116/117

**ERAGON** modular  
Ø 5.0 MM, INSULATED







		Handle, axial			
 All jaw inserts and sheath tubes can also be combined with ERAGONaxial					
		with lock	without lock, with HF connector	without lock, with HF connector	with lock, not rotatable
Rotatable knob	Product no.	83930082	83930083	83930084	83930085
	8988	•	•	•	

Jaw insert		Sheath tube, Ø 5.0 mm, insulated	Handle, pistol-shaped			Complete instrument	
		 SL 330 mm				• Jaw insert with sheath tube • Handle	
	JL*	Product no.	8393933	83930072	83930073	83930074	Product no.
 <b>Plate-shaped grasping forceps mono Ø 5 mm bndl</b> fenestrated with fine cross tothing, double-action	18 mm	8393.182	•			•	<b>83931827</b>
 <b>Grasping forceps mono Ø 5 mm bndl</b> with cross tothing, double-action	21 mm	8393.183	•		•		<b>83931837</b>
 <b>Grasping forceps mono Ø 5 mm bndl</b> distal cross tothing with channel, double-action	15 mm	8393.287	•		•		<b>83932877</b>
 <b>Claw grasping forceps Ø 5 mm bndl</b> double-action	27 mm	8393.494	•	•			<b>83934945</b>

\* JL = jaw length when jaw section closed (approximate measurements)

HF connection cable: see sheet BDE116/117

**ERAGON** modular  
Ø 5.0 MM, INSULATED

Jaw insert			Sheath tube, Ø 5.0 mm, insulated		Handle, pistol-shaped			Complete instrument • Jaw insert with sheath tube • Handle
			SL 330 mm	SL 450 mm	with lock, without HF	without lock, with HF, mono	with lock, with HF, mono	
	JL*	Product no.	8393933	8394933	83930072	83930073	83930074	Product no.
<b>Myoma grasping forceps</b> Ø 5 mm bndl  2x3-claw, single-action	29 mm	8393.488	•		•			<b>83934887</b>
<b>Universal grasping forceps mono</b> Ø 5 mm bndl  with pyramid-shaped tothing and cross tothing, double-action	18 mm	8393.481	•				•	<b>83934817</b>
<b>Universal grasping forceps</b> Ø 5 mm bndl  pyramid-shaped tothing and cross tothing, double-action	26 mm	8393.482	•		•			<b>83934827</b>
<b>Grasping forceps mono</b> Ø 5 mm bndl  Pike-mouth, double-action	20 mm	8393.483	•				•	<b>83934837</b>
<b>Biopsy forceps mono</b> Ø 5 mm bndl  with spikes, double-action	13 mm	8393.091	•				•	<b>83930917</b>
		8394.091		•		•		<b>83940917</b>
<b>Biopsy forceps mono</b> Ø 5 mm bndl  severing, single-action	14 mm	8393.092	•				•	<b>83930927</b>
		8394.092		•		•		<b>83940927</b>

\* JL = jaw length when jaw section closed (approximate measurements)







HF connection cable: see sheet BDE116/117









11123 || Subject to modifications. Please note that some products may not be available in all countries. Please always take note of the information that is provided with the product. For more detailed information, please consult with your contact partner or directly with Richard Wolf GmbH.

**ERAGON** modular  
Ø 5.0 MM, INSULATED

ERAGONMODULAR

4

		Handle, axial			
 All jaw inserts and sheath tubes can also be combined with ERAGONaxial					
		with lock	without lock, with HF connector	without lock, with HF connector	with lock, not rotatable
Rotatable knob	Product no.	83930082	83930083	83930084	83930085
	8988	•	•	•	







Jaw insert			Sheath tube, Ø 5.0 mm, insulated		Handle, pistol-shaped		Complete instrument • Jaw insert with sheath tube • Handle
							
	JL*	Product no.	SL 330 mm	SL 450 mm	with lock, without HF	without lock, with HF, mono	Product no.
 Biopsy forceps mono Ø 5 mm bndl	20 mm	8393.093	•			•	<b>83930937</b>
 Knot pusher Ø 5 mm bndl	17 mm	8393.345	•		•		<b>83933457</b>
		8394.345		•	•		<b>83943457</b>
 Grasping forceps Ø 5 mm bndl	37 mm	8393.188	•		•		<b>83931887</b>
 Grasping forceps Ø 5 mm bndl	47 mm	8393.189	•		•		<b>83931897</b>
		8394.189		•	•		<b>83941897</b>

\* JL = jaw length when jaw section closed (approximate measurements)  
HF connection cable: see sheet BDE116/117

III23 || Subject to modifications. Please note that some products may not be available in all countries. Please always take note of the information that is provided with the product. For more detailed information, please consult with your contact partner or directly with Richard Wolf GmbH.



**ERAGON** modular  
Ø 5.0 MM, INSULATED

Jaw insert			Sheath tube, Ø 5.0 mm, insulated		Handle, pistol-shaped		Complete instrument • Jaw insert with sheath tube • Handle
			SL 330 mm	SL450 mm	with lock, without HF	with lock, with HF, mono	
	JL*	Product no.	8393933	8394933	83930072	83930074	Product no.
 <b>Debaquey forceps</b> Ø 5 mm bndl atraumatic, spring jaw sections with cross toothing, double-action	47 mm	8393.291	•		•		<b>83932917</b>
 <b>Dissector forceps mono</b> Ø 5 mm bndl angled, double-action	18 mm	8393192	•			•	<b>83931927</b>
		8394192		•		•	<b>83941927</b>
 <b>Grasping forceps, mono</b> Ø 5 mm bndl double-action	16 mm	8393193	•		•		<b>83931937</b>
		8394193		•	•		<b>83941937</b>
 <b>Dissector forceps mono</b> Ø 5 mm bndl double-action	24 mm	8393194	•			•	<b>83931947</b>
		8394194		•		•	<b>83941947</b>
 <b>Dissector forceps mono</b> Ø 5 mm bndl double-action	30 mm	8393197	•			•	<b>83931977</b>
		8394197		•		•	<b>83941977</b>
 <b>Dissector forceps mono</b> Ø 5 mm bndl fine tips double-action	33 mm	8393198	•			•	<b>83931987</b>
		8394198		•		•	<b>83941987</b>







\* JL = jaw length when jaw section closed (approximate measurements)







HF connection cable: see sheet BDE116/117

**ERAGON** modular  
Ø 5.0 MM, INSULATED

ERAGONMODULAR

4

		Handle, axial			
 All jaw inserts and sheath tubes can also be combined with ERAGONaxial					
		with lock	without lock, with HF connector	without lock, with HF connector	with lock, not rotatable
Rotatable knob	Product no.	83930082	83930083	83930084	83930085
	8988	•	•	•	









Jaw insert		Sheath tube, Ø 5.0 mm, insulated		Handle, pistol-shaped	Complete instrument
					• Jaw insert with sheath tube • Handle
	JL*	SL 330 mm	SL 450 mm	with lock, with HF, mono	Product no.
 Dissector forceps mono Ø 5 mm bndl 32 mm double-action		8393933	8394933	83930074	83931997
		8394199	•	•	•
 Dissector forceps mono Ø 5 mm bndl 19 mm fine tip, double-action		8393200			83932007
		8394200	•	•	•
 Atraumatic grasping forceps mono Ø 5 mm bndl 16 mm atraumatic, with cross toothing, double-action		8393210			83932107
		8393220	•		•
 Atraumatic grasping forceps mono Ø 5 mm bndl 19mm atraumatic, with cross toothing, double-action		8393220			83932207
		8394220	•	•	•

\* JL = jaw length when jaw section closed (approximate measurements)  
 HF connection cable: see sheet BDE116/117

11123 || Subject to modifications. Please note that some products may not be available in all countries. Please always take note of the information that is provided with the product. For more detailed information, please consult with your contact partner or directly with Richard Wolf GmbH.

**ERAGON** modular

Ø 5.0 MM, INSULATED

Jaw insert			Sheath tube, Ø 5.0 mm, insulated		Handle, pistol-shaped		Complete instrument • Jaw insert with sheath tube • Handle
							
			SL 330 mm	SL 450 mm	with lock, without HF	with lock, with HF, mono	
	JL*	Product no.:	8393933	8394933	83930072	83930074	Product no.:
 <b>Atraumatic grasping forceps Ø 5 mm bndl</b> atraumatic, with pyramid-shaped tothing and cross tothing, double-action	29 mm	8393223	•		•		<b>83932237</b>
		8394223		•	•		<b>83942237</b>
 <b>Atraumatic grasping forceps Ø 5 mm bndl</b> atraumatic, single fenestrated with cross tothing, double-action	25 mm	8393250	•		•		<b>83932507</b>
		8394250		•	•		<b>83942507</b>
 <b>Atraumatic grasping forceps Ø 5 mm bndl</b> atraumatic, double fenestrated and curved single-action	32 mm	8393229	•		•		<b>83932297</b>
		8394229		•	•		<b>83942297</b>
 <b>Grasping forceps Ø 5 mm bndl</b> atraumatic, narrow and rounded, double-action	15 mm	8393230	•		•		<b>83932307</b>
		8394230		•	•		<b>83942307</b>
 <b>Dissector forceps mono Ø 5 mm bndl</b> curved, double-action	19 mm	8393240	•			•	<b>83932407</b>
		8394240		•		•	<b>83942407</b>
 <b>Dissector forceps mono Ø 5 mm bndl</b> single fenestrated double-action	17 mm	8393242	•		•		<b>83932427</b>
		8394242		•	•		<b>83942427</b>







\* JL = jaw length when jaw section closed (approximate measurements)





HF connection cable: see sheet BDE116/117

**ERAGON** modular  
Ø 5.0 MM, INSULATED

ERAGONMODULAR

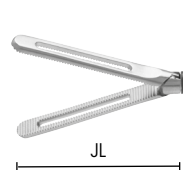



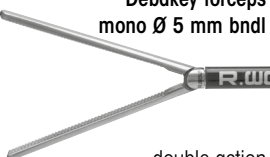



4

		Handle, axial			
 All jaw inserts and sheath tubes can also be combined with ERAGONaxial					
		with lock	without lock, with HF connector	without lock, with HF connector	with lock, not rotatable
Rotatable knob	Product no.	83930082	83930083	83930084	83930085
	8988	•	•	•	

Jaw insert			Sheath tube, Ø 5.0 mm, insulated		Handle, pistol-shaped		Complete instrument • Jaw insert with sheath tube • Handle
							
	JL*	Product no.	SL 330 mm	SL 450 mm	with lock, without HF	with lock, with HF, mono	Product no.
 Intestine grasping forceps Ø 5 mm bndl atraumatic, single fenestrated with cross toothing, double-action	38 mm	8393249	•		•		83932497
		8394249		•	•		83942497
 Debakey forceps mono Ø 5 mm bndl curved, double-action	35 mm	8393256	•			•	83932567
		8393258	•			•	83932587
 Debakey forceps mono Ø 5 mm bndl double-action	47 mm	8394258		•		•	83942587

\* JL = jaw length when jaw section closed (approximate measurements)  
 HF connection cable: see sheet BDE116/117

**ERAGON** modular  
Ø 5.0 MM, INSULATED

Jaw insert			Sheath tube, Ø 5.0 mm, insulated		Handle, pistol-shaped	Complete instrument • Jaw insert with sheath tube • Handle
						
			SL 330 mm	SL 450 mm	without lock, with HF, mono	
	JL*	Product no.	8393933	8394933	83930073	Product no.
 <b>Metzenbaum scissors mono Ø 5 mm bndl</b>	23 mm	8393.041	•		•	<b>83930417</b>
		8394.041		•	•	<b>83940417</b>
 <b>Metzenbaum micro scissors mono Ø 5 mm bndl</b>	18 mm	8393.044	•		•	<b>83930447</b>
 <b>Scissors mono Ø 5 mm bndl</b>	20 mm	8393.045	•		•	<b>83930457</b>
 <b>Hook scissors mono Ø 5 mm bndl</b>	14 mm	8393.081	•		•	<b>83930817</b>
		8394.081		•	•	<b>83940817</b>
 <b>Metzenbaum micro scissors mono Ø 5 mm bndl</b>	21 mm	8393243	•		•	<b>83932437</b>
		8394243		•	•	<b>83942437</b>
 <b>Scissors mono Ø 5 mm bndl</b>	26 mm	8393246	•		•	<b>83932467</b>
		8394246		•	•	<b>83942467</b>







\* JL = jaw length when jaw section closed (approximate measurements)







HF connection cable: see sheet BDE116/117

**ERAGON** modular  
Ø 5.0 MM, INSULATED

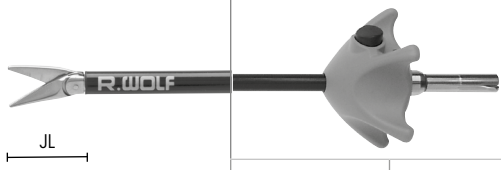
ERAGONMODULAR

4

		Handle, axial			
 All jaw inserts and sheath tubes can also be combined with ERAGONaxial					
		with lock	without lock, with HF connector	without lock, with HF connector	with lock, not rotatable
Rotatable knob	Product no.	83930082	83930083	83930084	83930085
	8988	•	•	•	

Jaw insert		Sheath tube, Ø 5.0 mm, insulated		Handle, pistol-shaped		Complete instrument	
 JL						• Jaw insert with sheath tube • Handle	
		SL 330 mm	SL 450 mm	with lock, without HF	without lock, with HF, mono		
	JL*	Product no.	8393933	8394933	83930072	83930073	Product no.
 <b>Scissors mono Ø 5 mm bndl</b> 22 mm	22 mm	8393248	•			•	<b>83932487</b>
		8394248		•		•	<b>83942487</b>
 <b>Knot pusher Ø 5 mm bndl</b> 17 mm	17 mm	8393.345	•		•		<b>83933457</b>
		8394345		•	•		<b>83943457</b>
 <b>Gastric band manipulator Ø 5 mm bndl</b> 47 mm	47 mm	8393253	•		•		<b>83932537</b>
		8394253		•	•		<b>83942537</b>



\* JL = jaw length when jaw section closed (approximate measurements)



HF connection cable: see sheet BDE116/117

Accessories for manual and machine reprocessing		Product no.
	<b>Irrigation adapter</b> Ø 9 mm, length 64 mm	<b>163502</b>

III23 | Subject to modifications. Please note that some products may not be available in all countries. Please always take note of the information that is provided with the product. For more detailed information, please consult with your contact partner or directly with Richard Wolf GmbH.

**ERAGON<sup>modu</sup> blades**  
 Ø 5.0 MM, INSULATED

 All jaw inserts and sheath tubes can also be combined with <b>ERAGONaxial</b>		Handle, axial 	
		without lock, with HF connector	
Rotatable knob	Product no.	83930083	
	8988	•	





Scissors attachment	Tension rod Ø 5.0 mm			Sheath tube insulated Ø 5.0 mm			Handle pistol-shaped	Complete instrument • Jaw insert with sheath tube • Handle	
									
	for SL 260 mm	for SL 330 mm	for SL 450 mm	SL 240 mm	SL 310 mm	SL 430 mm	without lock, rotatable with HF connector		
	Product no.	8392934	8393934	8394934	8392935	8393935	8394935	83930073	Product no.
<b>Metzenbaum scissors attachment mono</b>		•			•			•	<b>83920407</b>
	4393040		•			•		•	<b>83930407</b>
(PACK= 10 PCS), sterile, disposable				•			•	•	<b>83940407</b>









11123 || Subject to modifications. Please note that some products may not be available in all countries. Please always take note of the information that is provided with the product. For more detailed information, please consult with your contact partner or directly with Richard Wolf GmbH.

HF connection cable: see sheet BDE116/117

**ERAGON** modular  
Ø 10 MM, UNINSULATED

		Handle, axial	
 All jaw inserts and sheath tubes can also be combined with <b>ERAGONaxial</b>			
		with lock, without HF connector	with lock, without HF connector, not rotatable
Rotatable knob	Product no.	83930082	83930085
	8988	.	.

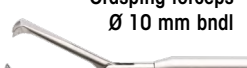





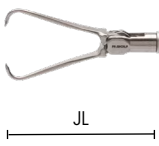

Jaw insert		Sheath tube, Ø 10.0 mm, insulated		Handle, pistol-shaped	Complete instrument	
					<ul style="list-style-type: none"> <li>Jaw insert with sheath tube</li> <li>Handle</li> </ul>	
		SL 327 mm	SL 447 mm	with lock, without HF		
	JL*	Product no.	8395902	8396902	83930072	Product no.
 Maryland dissector forceps Ø 10 mm bndl	36 mm	8395.225	.	.	.	<b>83952257</b>
		double-action	8396225	.	.	.
 Dissector forceps Ø 10 mm bndl	35 mm	8395.226	.	.	.	<b>83952268</b>
		angled, double-action	8396226	.	.	.
 Grasping forceps Ø 10 mm bndl	20 mm	8395.236	.	.	.	<b>83952368</b>
		Pike-mouth double-action	8396236	.	.	.
 Grasping forceps Ø 10 mm bndl	49 mm	8395.204	.	.	.	<b>83952048</b>
		2/3 jaws single-action	8396204	.	.	.

\* JL = jaw length when jaw section closed (approximate measurements)  
 HF connection cable: see sheet BDE116/117

III23 || Subject to modifications. Please note that some products may not be available in all countries. Please always take note of the information that is provided with the product. For more detailed information, please consult with your contact partner or directly with Richard Wolf GmbH.

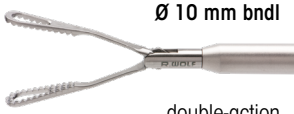





**ERAGON** modular  
Ø 10 MM, UNINSULATED





Jaw insert			Sheath tube, Ø 10.0 mm, insulated			Handle, pistol-shaped		Complete instrument • Jaw insert with sheath tube • Handle
			SL 327 mm	SL 447 mm	SL 387 mm	with lock, without HF		
	JL*	Product no.	8395902	8396902	8397902	83930072	83930082	Product no.
 Claw grasping forceps Ø 10 mm bndl double-action	38 mm	8395.489	•			•		83954897
 Claw grasping forceps Ø 10 mm bndl with additional row of teeth, double-action	38 mm	8395490	•			•		83954907
 Babcock forceps Ø 10 mm bndl large distal gripping surface with fine cross toothing, double-action	42 mm	8395.187	•			•		83951877
 Babcock forceps Ø 10 mm bndl double-action	38 mm	8395.214	•			•		83952148
 Plate-shaped grasping forceps Ø 10 mm bndl double-action	50 mm	8395.234	•			•		83952347
 Plate-shaped grasping forceps Ø 10 mm bndl double-action		8396234		•		•		83962347
 Spoon forceps Ø 10 mm bndl single-action	31 mm	8395.244	•			•		83952448
 Stapler head grasping forceps Ø 10 mm bndl angled 30°, double-action		8397.655			•		•	83976558

\* JL = jaw length when jaw section closed (approximate measurements)/HF connection cable: see sheet BDE116/117

11123 || Subject to modifications. Please note that some products may not be available in all countries. Please always take note of the information that is provided with the product. For more detailed information, please consult with your contact partner or directly with Richard Wolf GmbH.

**ERAGON** modular  
ACCESSORIES



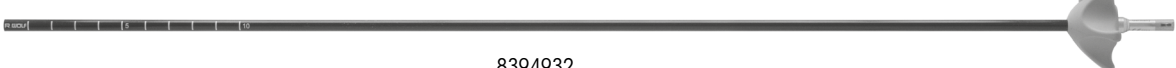

For insulated sheath tubes		Product no.
	For manual and machine reprocessing:  <b>Irrigation adapter</b> Ø 9 mm, length 64 mm for insulated sheath tubes	<b>163502</b>
		





For uninsulated sheath tubes		Product no.
	For manual and machine reprocessing:  <b>Irrigation adapter cleaning</b> Ø 9 mm, length 64 mm for uninsulated sheath tubes	<b>163503</b>
		



	<b>8393932</b>
	<b>8394932</b>

		Ø	SL	Product no.
ERAGONmodular	<b>Sheath tube insulated Ø 5 mm SL 330 mm</b> with distal cm scale	5 mm	330 mm	<b>8393932</b>
	<b>Sheath tube insulated Ø 5 mm SL 450 mm</b> with distal cm scale	5 mm	450 mm	<b>8394932</b>

## HANDLE VARIANTS FOR MODULAR SYSTEMS

Handle, pistol-shaped 	rotatable	with lock	without lock	with HF	without HF	Product no.
	•	•			•	83930072
	•		•	•		83930073
	•	•		•		83930074

Handle, axial 	rotatable	with lock	without lock	with HF	without HF	Product no.
	•	•			•	83930082
	•		•	•		83930083
	•	•		•		83930084
		•			•	83930085

Optional for 83930082/83930083/83930084:		Product no.
 	Rotatable knob autoclavable	8988

All ERAGON<sup>modular</sup> components are compatible with ERAGON<sup>axial</sup>

# CHOLANGIOGRAPHY CATHETERGRASPING FORCEPS 5 MM

FORCEPS

5

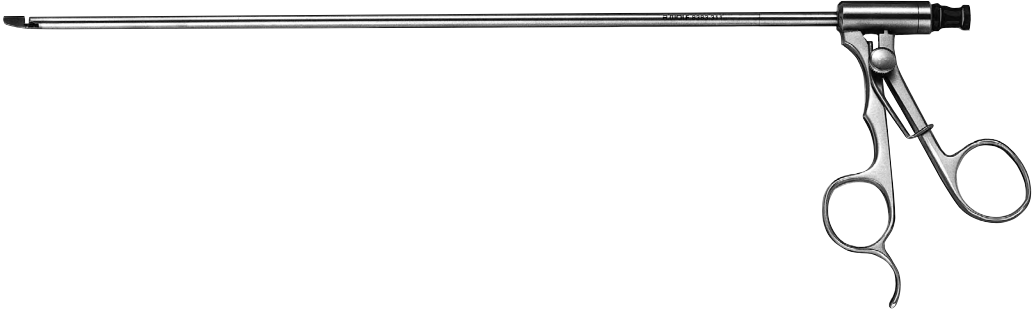







		Outer Ø	WL	Product no.
	Grasping forceps Ø 5 mm WL 295 mm	5.0 mm	295 mm	<b>8383.311</b>

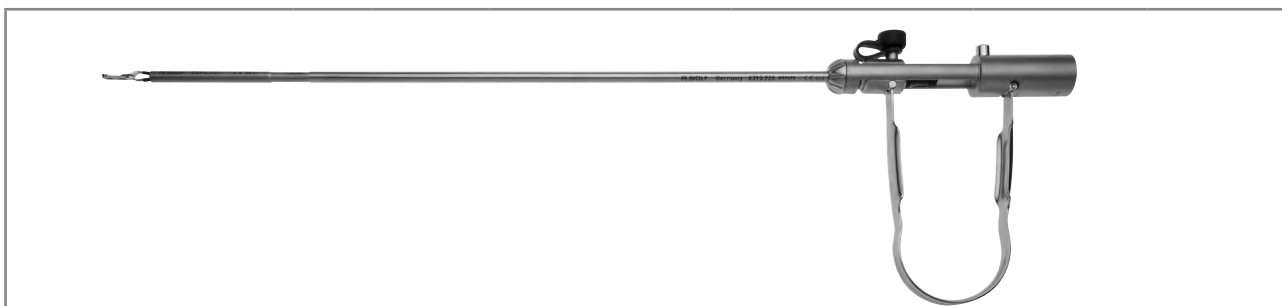

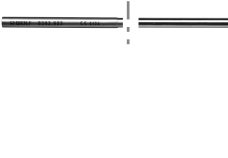

- For inserting a cholangiography catheter up to 7 Fr into the cystic duct

# BIPOLAR FORCEPS 3.5 MM/5.0 MM

WITH SPRING HANDLE  
MODULAR SYSTEM

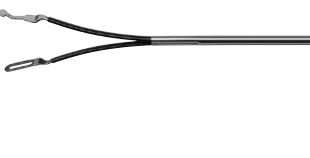

Grasping forceps jaw insert			Outer tube Ø 3.5 mm SL 348 mm	Screw cap with sleeve Ø 5.0 mm SL 107 mm	Spring handle bipo	complete instrument
						<ul style="list-style-type: none"> <li>• Jaw insert</li> <li>• Sliding sleeve</li> <li>• Outer tube</li> <li>• Spring handle</li> </ul>
	JL*	Product no.	8391.921	8393.978	8393.975	Product no.
	39 mm	8391.715	•	•	•	<b>8391.742</b>







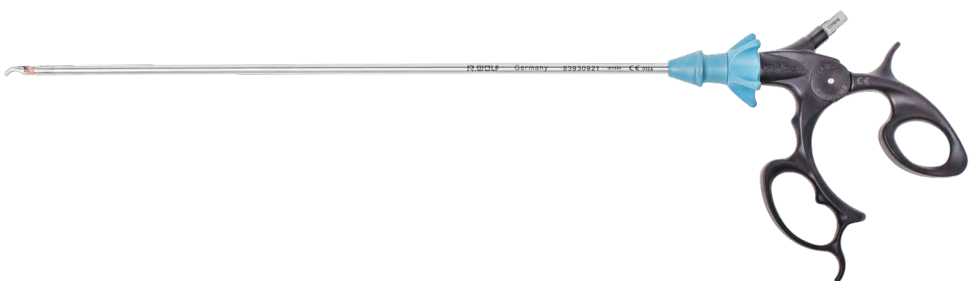

Kleppinger grasping forceps jaw insert			Sliding sleeve SL 319 mm	Outer tube Ø 5 mm SL 237 mm	Spring handle bipo	complete instrument
						<ul style="list-style-type: none"> <li>• Jaw insert</li> <li>• Sliding sleeve</li> <li>• Outer tube</li> <li>• Spring handle</li> </ul>
	JL*	Product no.	8393.923	8393.925	8393.975	Product no.
	53 mm	8393.714	•	•	•	<b>8393.741</b>

Accessories	Product no.
RIWO rubber cap, jet black	15220.019
Luer sealing cap	15023.153

\* JL = jaw length when jaw section closed (approximate measurements)  
Bipolar connection cable: see sheet BDE118/119

11123 || Subject to modifications. Please note that some products may not be available in all countries. Please always take note of the information that is provided with the product. For more detailed information, please consult with your contact partner or directly with Richard Wolf GmbH.





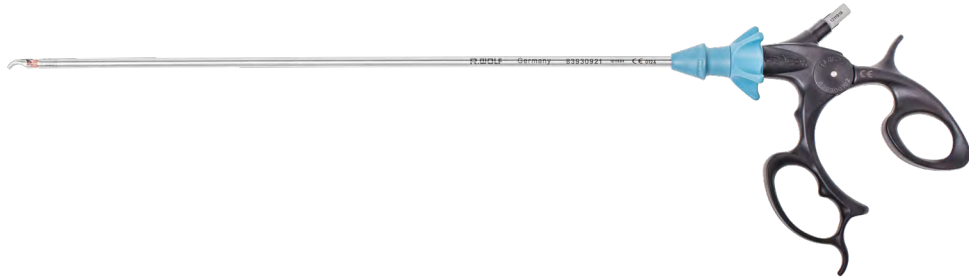

**ERAGON** bipolar  
MODULAR BIPOLAR INSTRUMENTS, 5.5 MM  
ROTATABLE

		Jaw insert		Sheath tube Ø 5.5 mm		Handle, pistol-shaped, bipo	Complete instrument • Jaw insert • Sheath tube • Handle
							
				SL 320 mm	SL 435 mm	rotatable	
	JL*	Product no.	83930921	82340024	839300102	Product no.	
	21 mm	83930031	•		•	<b>839300312</b>	
		839400310			•	<b>839400312</b>	
	23 mm	83930032	•		•	<b>839300322</b>	
		839400320			•	<b>839400322</b>	
	21 mm	83930033	•		•	<b>839300332</b>	
		839400330			•	<b>839400332</b>	
	23 mm	83930034	•		•	<b>839300342</b>	
		839400340			•	<b>839400342</b>	
	19 mm	83930035	•		•	<b>839300352</b>	
		839400350			•	<b>839400352</b>	

\* JL = jaw length when jaw section closed (approximate measurements)  
Bipolar connection cable: see sheet BDE118/119

**ERAGON** bipolar  
MODULAR BIPOLAR INSTRUMENTS, 5.5 MM,  
ROTATABLE



Jaw insert			Sheath tube Ø 5.5 mm		Handle, pistol-shaped, bipo	Complete instrument • Jaw insert • Sheath tube • Handle
						
			SL 320 mm	SL 435 mm	rotatable	
	JL*	Product no.	83930921	82340024	839300102	Product no.
	19 mm	83930036	•		•	839300362
	22 mm	83930037	•		•	839300372
		83930038	•		•	839300382
	15 mm	839400380		•	•	839400382
	22 mm	83930041	•		•	839300412
		839400410		•	•	839400412



\* JL = jaw length when jaw section closed (approximate measurements)  
Bipolar connection cable: see sheet BDE118/119

11123 || Subject to modifications. Please note that some products may not be available in all countries. Please always take note of the information that is provided with the product. For more detailed information, please consult with your contact partner or directly with Richard Wolf GmbH.





# ELECTRODES 2.0 MM/3.5 MM

## MONOPOLAR



		Outer Ø	WL	Product no.
	Coagulation electrode mono 5 FR WL 400 mm	1.67 mm	400 mm	<b>823.05</b>
	Coagulation electrode mono 6 FR WL 400 mm	2.0 mm	400 mm	<b>823.06</b>



		Outer Ø	WL	Product no.
	Hook electrode mono Ø 3.5 mm WL 310 mm	3.5 mm	310 mm	<b>8379.452</b>
	Hook electrode mono Ø 3.5 mm WL 240 mm with distally extended insulation	3.5 mm	240 mm	<b>8785.642</b>
	Needle electrode mono Ø 3.5 mm WL 310 mm	3.5 mm	310 mm	<b>8379.482</b>
	Coagulation electrode mono Ø 3.5 mm WL 310 mm	3.5 mm	310 mm	<b>8379.462</b>

HF connection cable: see sheet BDE116/117







# ELECTRODES 5.0 MM

## MONOPOLAR



		Outer Ø	WL	Product no.
	Coagulation electrode mono Ø 5 mm WL 330 mm	5.0 mm	330 mm	<b>8383.40</b>
	Coagulation electrode mono Ø 5 mm WL 450 mm	5.0 mm	450 mm	<b>8384.40</b>



		Outer Ø	WL	Product no.
	Hook electrode mono Ø 5 mm WL 340 mm	5.0 mm	340 mm	<b>8383.423</b>
	Hook electrode mono Ø 5 mm WL 420 mm		420 mm	<b>8384.423</b>
	Needle electrode mono Ø 5 mm WL 340 mm	5.0 mm	340 mm	<b>8383.426</b>
	Spatula electrode mono Ø 5 mm WL 340 mm	5.0 mm	340 mm	<b>8383.428</b>
	Myoma dissector mono Ø 5 mm WL 340 mm	5.0 mm	340 mm	<b>8383429</b>

HF connection cable: see sheet BDE116/117

# MULTIFUNCTIONAL SUCTION IRRIGATION SYSTEM

## COMBINATION OPTIONS

MULTIFUNCTIONAL SUCTION IRRIGATION SYSTEM

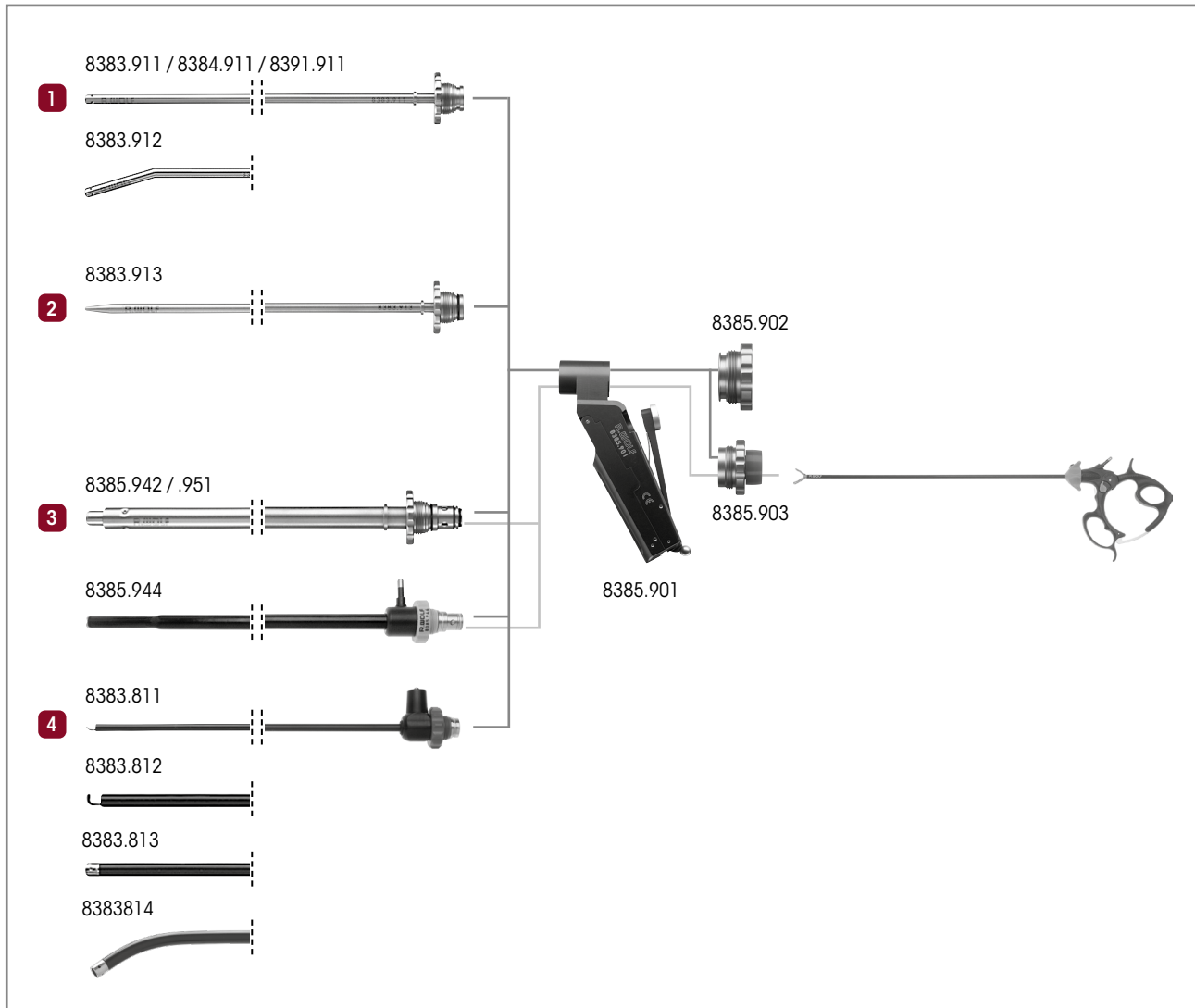

- 1 Suction or irrigation:**
- Suction irrigation tube Ø 5 mm WL 310 mm ..... 8383.911
  - Suction irrigation tube Ø 5 mm WL 450 mm ..... 8384.911
  - Suction irrigation tube Ø 3.5 mm WL 300 mm ..... 8391.911
  - Suction irrigation tube curved Ø 5 mm WL 310 mm... 8383.912
  - for this: **Sealing cap** ..... 8385.902

- 2 Blunt aquadissection:**
- Pressure irrigation tube Ø 5 mm WL 310 mm ..... 8383.913
  - for this: **Sealing cap** ..... 8385.902

- 3 Suction, irrigation, and use of auxiliary instruments Ø 5 mm:**
- Suction irrigation tube Ø 10 mm WL 225 mm ..... 8385.942
  - Suction irrigation tube Ø 10 mm WL 330 mm ..... 8385.951
  - Suction irrigation tube Ø mono 10 mm WL 330 mm, insulated, with atraumatic preparation tip ..... 8385.944
  - for this: **Sealing adapter** ..... 8385.903

- 4 Preparation of tissue with HF:**
- HF suction irrigation tube Ø 5.2 mm WL 317 mm insulated with integrated HF spatula probe** ..... 8383.811
  - HF suction irrigation tube Ø 5.2 mm WL 317 mm insulated with integrated HF hook electrode** ..... 8383.812
  - HF suction irrigation tube Ø 5.2 mm WL 317 mm insulated with integrated HF button electrode** ..... 8383.813
  - HF suction irrigation tube Ø 5.4 mm WL 380 mm curved with distal openings, insulated with integrated HF button electrode** ..... 8383.814
  - for this: **Sealing cap** ..... 8385.902

III23 || Subject to modifications. Please note that some products may not be available in all countries. Please always take note of the information that is provided with the product. For more detailed information, please consult with your contact partner or directly with Richard Wolf GmbH.

# MULTIFUNCTIONAL SUCTION IRRIGATION SYSTEM

## SUCTION IRRIGATION HANDLE

 <p>8385.901</p> <p><b>AUTOGLAVE</b> <b>134° C / 273° F</b></p> <p>8385.902</p> <p>8385.903</p>	
<b>Product no.</b>	
<p><b>Suction irrigation handle</b></p>	<p><b>8385.901</b></p>
<p><b>Sealing cap</b></p>	<p><b>8385.902</b></p>
<p>Required to use auxiliary instruments Ø 5 mm: <b>Sealing attachment</b> with opening and membrane valve</p>	<p><b>8385.903</b></p>
<p>Spare <b>Sealing membrane Ø 17 mm</b> yellow, Ø 17 mm, PACK= 10 PCS, for instruments from 3 to 6 mm</p>	<p><b>89.103</b></p>

# MULTIFUNCTIONAL SUCTION IRRIGATION SYSTEM

## SUCTION IRRIGATION TUBE SETS – ILLUSTRATION

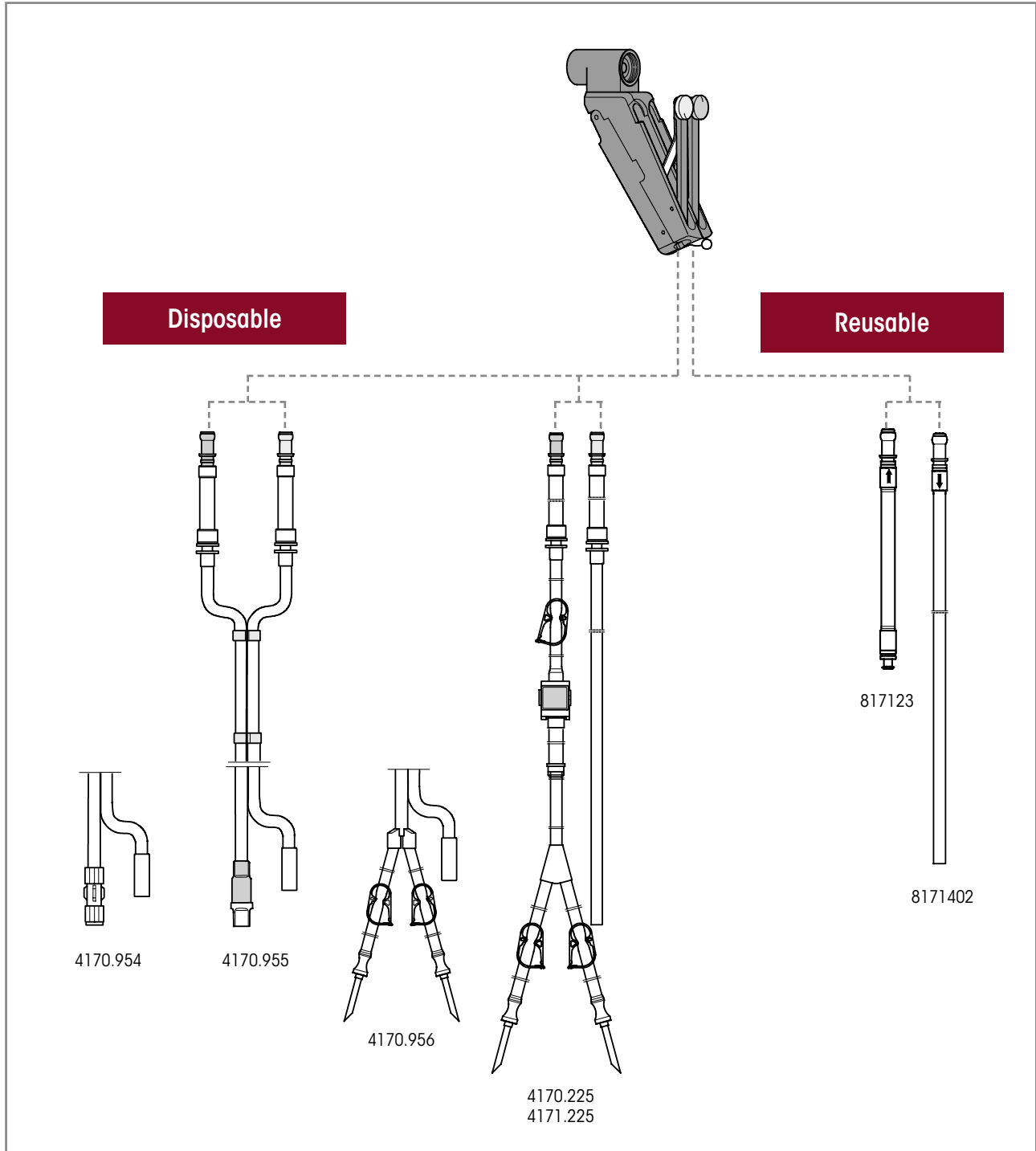

**Suction irrigation tube sets** are used in conjunction with the suction irrigation handle 8385.901 and pump-side tube systems as well as corresponding collection and secretion containers and/or vacuum pumps (e.g., FLUID CONTROL LAP 2216, LAPARO PUMP 2215)

# MULTIFUNCTIONAL SUCTION IRRIGATION SYSTEM

## SUCTION IRRIGATION TUBE SETS FOR SUCTION IRRIGATION HANDLE 8385.901







Disposable		Product no.
<b>Suction irrigation tube set, L 3 m</b>  (PACK= 10 PCS), sterile	<b>Irrigation tube:</b> With Luer-Lock, for connection to the irrigation tube of a suction irrigation tube set, e.g., irrigation tube of the Endo-Irrigator 2211 <b>Suction tube:</b> For connection to a collection or secretion container and/or vacuum pump	<b>4170.954</b>
<b>Suction irrigation tube set with care-lock, L 3 m</b>  (PACK= 10 PCS), sterile	<b>Irrigation tube:</b> With CARE-LOCK, for connection to an irrigation container <b>Suction tube:</b> For connection to a collection or secretion container and/or vacuum pump	<b>4170.955</b>
<b>Suction irrigation tube set with piercing spike, L 3 m</b>  (PACK= 10 PCS), sterile	<b>Irrigation tube:</b> With 2 piercing spikes, for connection to an irrigation container <b>Suction tube:</b> For connection to a collection or secretion container and/or vacuum pump	<b>4170.956</b>
<b>Suction irrigation tube set with piercing spike, L 3 m</b>  (PACK= 10 PCS), sterile	<b>Irrigation tube:</b> With 2 piercing spikes, for connection to an irrigation container, plus Laparo Pump 2215 and Fluid Control Lap 2216 <b>Suction tube:</b> For connection to a collection or secretion container and/or vacuum pump  Also observe instruction manual GA-A 167	<b>4170.225</b>
<b>Suction irrigation tube set, L 3 m</b>  (PACK= 10 PCS), sterile	<b>Irrigation tube:</b> With 2 piercing spikes, for connection to an irrigation container, and Fluid Control Lap 2216 <b>Suction tube:</b> For connection to a collection or secretion container and/or vacuum pump  Also observe instruction manual GA-A 276	<b>4171.225</b>
<b>Secretion container, 2.5 l</b>	2.5 liters	<b>41706566</b>
<b>Tube set for suction (2 connections)</b>	sterile disposable product (PACK= 10 PCS), for connecting instruments to collecting container	<b>T0503-01</b>
Reusable		Product no.
<b>Irrigation tube L 1.2 m</b>	<b>Irrigation tube:</b> With Luer-Lockconnection for connection to the irrigation tube of a suction irrigation tube set, e.g., 8171223 or 8170.223	<b>817123</b>
<b>Suction tube L 3 m</b>	silicone, for suction irrigation handle 8385.901	<b>8171402</b>
<b>Secretion container, 2 l</b>	2 liters, with lid	<b>8170.655</b>
<b>Secretion container, 2 l</b>	2 liters, no lid	<b>8170.6551</b>

# MULTIFUNCTIONAL SUCTION IRRIGATION SYSTEM

## SUCTION IRRIGATION TUBES

MULTIFUNCTIONAL SUCTION IRRIGATION SYSTEM

8





		Outer Ø	WL	Product no.
				
	Suction irrigation tube Ø 3.5 mm WL 300 mm	3.5 mm	300 mm	<b>8391.911</b>
	Suction irrigation tube Ø 5 mm WL 310 mm	5.0 mm	310 mm	<b>8383.911</b>
	Suction irrigation tube Ø 5 mm WL 450 mm	5.0 mm	450 mm	<b>8384.911</b>
	Suction irrigation tube curved Ø 5 mm WL 310 mm	5.0 mm	310 mm	<b>8383.912</b>
	Pressure irrigation tube Ø 5 mm WL 310 mm	5.0 mm	310 mm	<b>8383.913</b>
for use of 5 mm auxiliary instruments				
 capacity 5.0 mm	Suction irrigation tube Ø 10 mm WL 225 mm	10.0 mm	225 mm	<b>8385.942</b>
	Suction irrigation tube Ø 10 mm WL 330 mm	10.0 mm	330 mm	<b>8385.951</b>
 insulated, with atraumatic preparation tip	Suction irrigation tube mono Ø 10 mm WL 330 mm	10.0 mm	330 mm	<b>8385.944</b>
	required for 8385.951:  <b>Sealing attachment</b> with opening and membrane valve Sealing membrane Ø 17 mm			<b>8385.903</b>

III23 || Subject to modifications. Please note that some products may not be available in all countries. Please always take note of the information that is provided with the product. For more detailed information, please consult with your contact partner or directly with Richard Wolf GmbH.

# MULTIFUNCTIONAL SUCTION IRRIGATION SYSTEM

## SUCTION IRRIGATION TUBES



		Outer Ø	WL	Product no.
 insulated with integrated HF spatula probe	<b>HF suction irrigation tube Ø 5.2 mm WL 317 mm</b>	5.2 mm	317 mm	<b>8383.811</b>
 insulated with integrated HF hook probe	<b>HF suction irrigation tube Ø 5.2 mm WL 317 mm</b>	5.2 mm	317 mm	<b>8383.812</b>
 insulated with integrated HF button electrode	<b>Suction irrigation tube Ø 5 mm WL 450 mm</b>	5 mm	317 mm	<b>8383.813</b>
as alternative to suction irrigation handle:				
	<b>Suction irrigation adapter</b> with maintenance-free two-way stopcock, for multifunctional suction irrigation system			<b>8583819</b>







Accessories	Product no.
HF connection cable	See page BDE116/117

11123 || Subject to modifications. Please note that some products may not be available in all countries. Please always take note of the information that is provided with the product. For more detailed information, please consult with your contact partner or directly with Richard Wolf GmbH.

# MULTIFUNCTIONAL SUCTION IRRIGATION SYSTEM

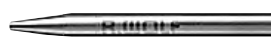
## SUCTION IRRIGATION TUBES





		Outer Ø	WL	Product no.
	Suction tube OD 2.8 mm WL 450 mm	2.8 mm	450 mm	<b>8380.68</b>
	Suction irrigation tube Ø 5 mm WL 310 mm	5.0 mm	310 mm	<b>8383.911</b>
	Suction irrigation tube Ø 5 mm WL 450 mm	5.0 mm	450 mm	<b>8384.911</b>
	Suction irrigation tube curved Ø 5 mm WL 310 mm	5.0 mm	310 mm	<b>8383.912</b>
	Pressure irrigation tube Ø 5 mm WL 310 mm	5.0 mm	310 mm	<b>8383.913</b>
for use of 5 mm auxiliary instruments				
 capacity 5.0 mm	Suction irrigation tube Ø 10 mm WL 225 mm	10.0 mm	225 mm	<b>8385.942</b>
	Suction irrigation tube Ø 10 mm WL 330 mm	10.0 mm	330 mm	<b>8385.951</b>
 insulated, with atraumatic preparation tip	Suction irrigation tube mono Ø 10 mm WL 330 mm	10.0 mm	330 mm	<b>8385.944</b>
	required for 8385.951:  <b>Sealing attachment</b> with opening and membrane valve, sealing membrane Ø 17 mm			<b>8385.903</b>

III23 || Subject to modifications. Please note that some products may not be available in all countries. Please always take note of the information that is provided with the product. For more detailed information, please consult with your contact partner or directly with Richard Wolf GmbH.

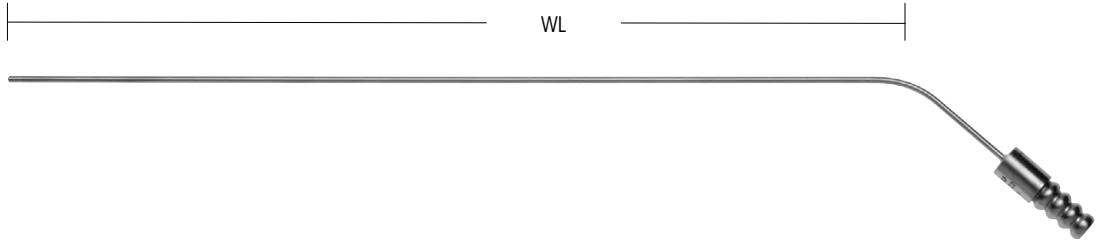

## ACCESSORIES FOR SUCTION AND IRRIGATION







		Outer Ø	WL	Product no.
 central, lateral openings, rigid	suction tube OD 2 mm WL 250 mm	2.0 mm	250 mm	<b>8291.22</b>
	suction tube OD 2.5 mm WL 250 mm	2.5 mm	250 mm	<b>8291.23</b>
	suction tube OD 3 mm WL 250 mm	3.0 mm	250 mm	<b>8291.24</b>
	suction tube OD 4 mm WL 500 mm	4.0 mm	500 mm	<b>8291.45</b>

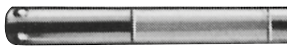

		Outer Ø	WL	Product no.
	Suction tube OD 2.8 mm WL 450 mm	2.8 mm	450 mm	<b>8380.68</b>

11123 || Subject to modifications. Please note that some products may not be available in all countries. Please always take note of the information that is provided with the product. For more detailed information, please consult with your contact partner or directly with Richard Wolf GmbH.

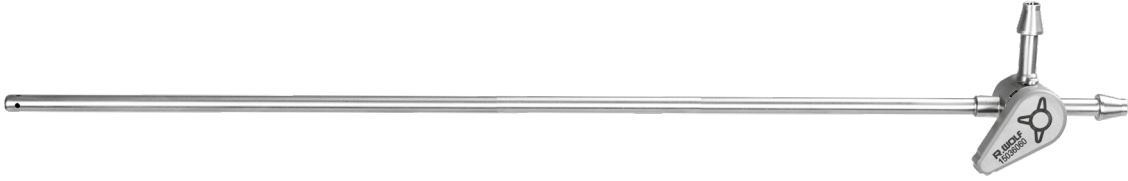
**ACCESSORIES**  
FOR SUCTION AND IRRIGATION

				
	<b>Suction tube graduated <math>\varnothing</math> 5 mm WL 330 mm</b>	<b>Outer <math>\varnothing</math></b>	<b>WL</b>	<b>Product no.</b>
graduated, with 3 mm Luer connector		5.0 mm	330 mm	<b>8383.68</b>
				
	<b>Suction irrigation tube <math>\varnothing</math> 5 mm WL 300 mm</b>	<b>Outer <math>\varnothing</math></b>	<b>WL</b>	<b>Product no.</b>
with stop valve		5.0 mm	300 mm	<b>8383.94</b>
				
	<b>Suction irrigation tube WL 290 mm</b>	<b>Outer <math>\varnothing</math></b>	<b>WL</b>	<b>Product no.</b>
with maintenance-free two-way stopcock, sheath tube, with distal openings, reusable	<b>Suction irrigation tube WL 410 mm</b>	5.0 mm	290 mm	<b>8583732</b>
		5.0 mm	410 mm	<b>8584732</b>

## ACCESSORIES / DISPOSABLE HAND BLOWER FOR SUCTION AND IRRIGATION



		Outer Ø	WL	Product no.
	Suction irrigation tube Ø 3 mm WL 300 mm	3.0 mm	330 mm	<b>8383.72</b>
with Luer connector				



		Outer Ø	WL	Product no.
	HF coagulation suction device mono Ø 5 mm WL 315 mm	5.0 mm	315 mm	<b>8383.71</b>
with Luer connector and a valve	HF coagulation suction device mono Ø 5 mm WL 350 mm	5.0 mm	450 mm	<b>8384.71</b>

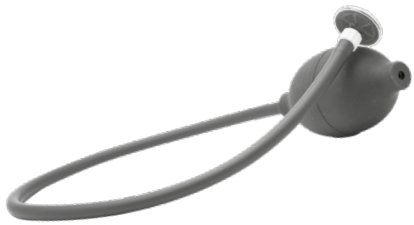

for air insufflation		Ø	TL	Product no.
	Hand blower with disposable filter, sterile (PACK= 5 PCS)	49 mm	567 mm	<b>412700</b>

HF connection cable: see sheet BDE116/117

# TISSUE RETRACTOR 5 MM

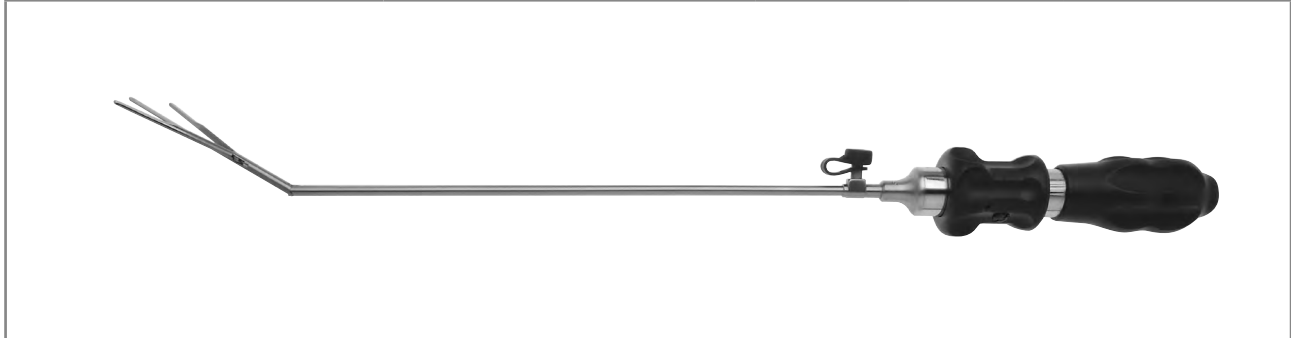



		Outer Ø	WL	Product no.
	tissue retractor Ø 5 mm WL 320 mm	5.0 mm	320 mm	<b>8383.691</b>

Accessories	Product no.
Luer sealing cap	<b>887.00</b>

III23 || Subject to modifications. Please note that some products may not be available in all countries. Please always take note of the information that is provided with the product. For more detailed information, please consult with your contact partner or directly with Richard Wolf GmbH.

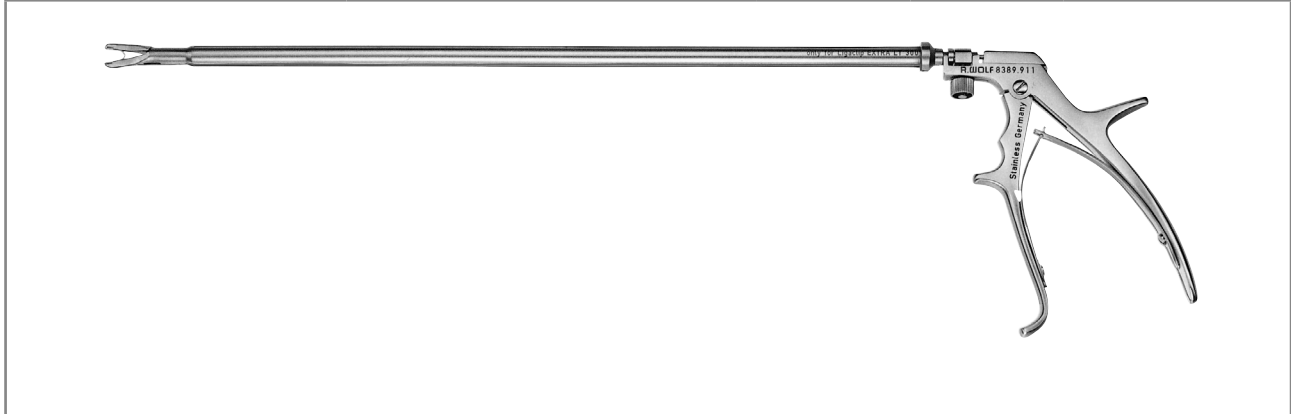
# CLIP APPLICATOR 10 MM FOR SUCTION AND IRRIGATION



		Outer Ø	WL	Product no.
	<b>Clip applicator</b> Ø 10 mm WL 340 mm	10 mm	340 mm	<b>8389.911</b>
<b>for this:</b>				<b>Product no.</b>
	<b>Introduction sleeve 10 mm WL 80 mm</b> with sealing cap			<b>8389.991</b>
For clip ligation with Ethicon® Ligaclip® EXTRA LT 300				
<b>Ethicon® Ligaclips®</b> (PACK= 108 PCS)				<b>8389.915</b>

Accessories	Product no.
Sealing cap capacity 9.5–10.1 mm	<b>89.08</b>

# ERAGON<sup>stitch</sup>

## THE ERGONOMIC GENERATION OF NEEDLE HOLDERS

Thanks to the custom combination options it offers, **ERAGON<sup>stitch</sup>** can accommodate any user requirement. The way in which it brings together ergonomics, versatility, modularity, and precision sets new standards in comfort

ERAGONSTITCH NEEDLE HOLDER

11

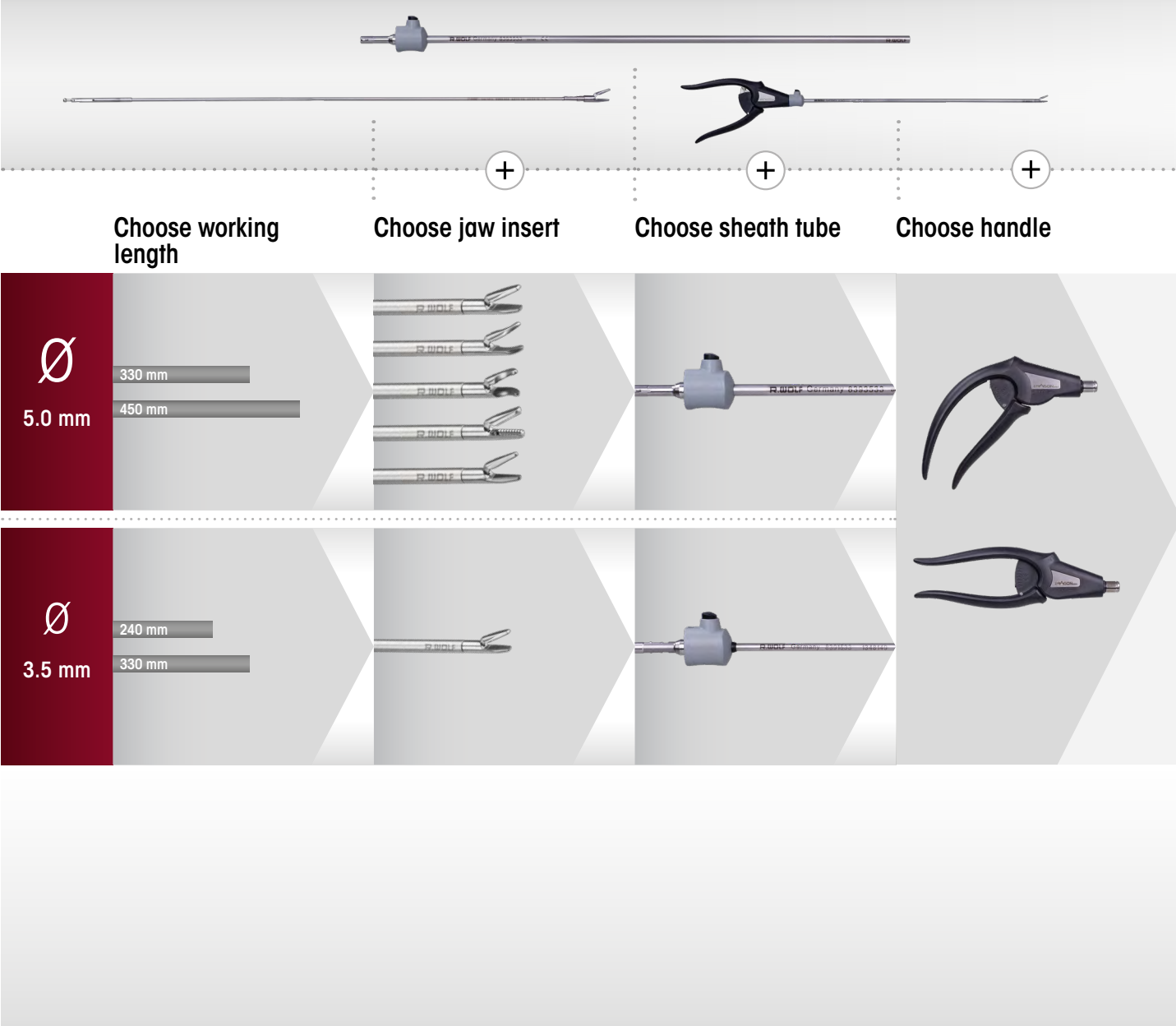





	Choose working length	Choose jaw insert	Choose sheath tube	Choose handle
<b>5.0 mm</b>	<ul style="list-style-type: none"> <li>330 mm</li> <li>450 mm</li> </ul>	<ul style="list-style-type: none"> <li>Standard</li> <li>Curved</li> <li>Hooked</li> <li>Hooked (longer)</li> </ul>	<ul style="list-style-type: none"> <li>Standard</li> </ul>	<ul style="list-style-type: none"> <li>Standard</li> </ul>
<b>3.5 mm</b>	<ul style="list-style-type: none"> <li>240 mm</li> <li>330 mm</li> </ul>	<ul style="list-style-type: none"> <li>Standard</li> </ul>	<ul style="list-style-type: none"> <li>Standard</li> </ul>	<ul style="list-style-type: none"> <li>Standard</li> </ul>

**ERAGONstitch needle holders**



**ERAGON<sup>stitch</sup>**  
NEEDLE HOLDER Ø 3.5 MM



Needle holder jaw insert			Sheath tube, Ø 3.5 mm		Needle holder handle		Complete instrument • Jaw insert • Sheath tube • Handle
							
							SL 240 mm
					Axial	Angled	
	JL*	Product no.	8390533	8391533	8393943	8393944	Product no.
	12 mm	8391505	•		•		<b>83915053</b>
			•		•		<b>83915054</b>
straight with carbide insert single-action		8391506		•	•		<b>83915063</b>
				•		•	<b>83915064</b>

\* JL = jaw length when jaw section closed (approximate measurements)





Accessories for manual and machine reprocessing	Product no.
	<b>Irrigation adapter cleaning</b> Ø 9 mm, length 64 mm for uninsulated sheath tubes  <b>163503</b>

1123 || Subject to modifications. Please note that some products may not be available in all countries. Please always take note of the information that is provided with the product. For more detailed information, please consult with your contact partner or directly with Richard Wolf GmbH.



# ERAGON<sup>stitch</sup>



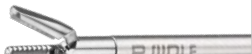

## NEEDLE HOLDER Ø 5.0 MM

Needle holder jaw insert			Sheath tube, Ø 5.0 mm		Needle holder handle		Complete instrument • Jaw insert • Sheath tube • Handle	
								
	JL*	Product no.	8393533	8394533	8393943	8393944	Product no.	
	19 mm	8393507	•		•		83935073	
			•			•	83935074	
straight with carbide insert single-action	19 mm	8394507		•	•		83945073	
				•		•	83945074	
	19 mm	8393508	•		•		83935083	
			•			•	83935084	
straight and narrow with carbide insert single-action	19 mm	8394508		•	•		83945083	
				•		•	83945084	
	19 mm	8393509	•		•		83935093	
			•			•	83935094	
straight, with self-righting function single-action	19 mm	8394509		•	•		83945093	
				•		•	83945094	

\* JL = jaw length when jaw section closed (approximate measurements)

Accessories for manual and machine reprocessing	Product no.
	<b>Irrigation adapter cleaning</b> Ø 9 mm, length 64 mm for uninsulated sheath tubes  <b>163503</b>

**ERAGON** *stitch*  
NEEDLE HOLDER Ø 5.0 MM

Needle holder jaw insert			Sheath tube, Ø 5.0 mm		Needle holder handle		Complete instrument • Jaw insert • Sheath tube • Handle
							
	JL*	Product no.	8393533	8394533	Axial 8393943	Angled 8393944	Product no.
	19 mm	Needle holder Ø 5 mm bndl	•		•		<b>83935183</b>
		curved right with carbide insert single-action	•			•	<b>83935184</b>
		8394518		•	•		<b>83945183</b>
				•		•	<b>83945184</b>
	19 mm	Needle holder Ø 5 mm bndl	•		•		<b>83935193</b>
		Curved left with carbide insert single-action	•			•	<b>83935194</b>
		8394519		•	•		<b>83945193</b>
				•		•	<b>83945194</b>











Accessories for manual and machine reprocessing	Product no.
 Irrigation adapter cleaning Ø 9 mm, length 64 mm for uninsulated sheath tubes	<b>163503</b>

III23 || Subject to modifications. Please note that some products may not be available in all countries. Please always take note of the information that is provided with the product. For more detailed information, please consult with your contact partner or directly with Richard Wolf GmbH.

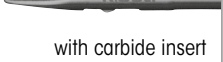
# NEEDLE HOLDER Ø 3.5 MM/5 MM

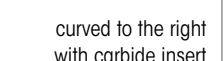
## MODULAR SYSTEM

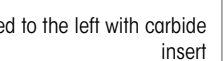

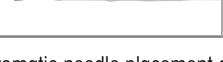

Needle holder jaw insert with sheath				Needle holder handle, axial		Complete instrument • Jaw insert • Sheath tube • Handle
						
	Product no.	Ø	SL	8393.941	Product no.	
 with carbide insert	8391504	3.5 mm	340 mm	•		<b>8391.501</b>
 for straight needles	8393504	5 mm	340 mm	•		<b>8393.501</b>
 with carbide insert	8393505	5 mm	340 mm	•		<b>8393.502</b>
 with carbide insert	8394505	5 mm	430 mm	•		<b>8394.502</b>
 curved to the right with carbide insert	8393514	5 mm	340 mm	•		<b>8393.511</b>
 curved to the right with carbide insert	8394514	5 mm	430 mm	•		<b>8394.511</b>
 curved to the left with carbide insert	8393515	5 mm	340 mm	•		<b>8393.512</b>
 curved to the left with carbide insert	8394515	5 mm	430 mm	•		<b>8394.512</b>
 Sarbu needle holder Ø 5 mm bndl	8393506	5 mm	340 mm	•		<b>8393.503*</b>
 Sarbu needle holder Ø 5 mm bndl	8394506	5 mm	430 mm	•		<b>8394.503*</b>

\* with automatic needle placement apparatus and cutting edge

# NEEDLE HOLDER HANDLE







Needle holder handle, axial	not rotatable	with lock	without HF	Product no.
	•	•	•	<b>8393.941</b>



Needle holder handle <small>ERAGON</small> <small>stitch</small>	axial	angled	with on-off detent mechanism	single-action	Not rotatable	Product no.
	•		•	•	•	<b>8393943</b>
		•	•	•	•	<b>8393944</b>

III23 || Subject to modifications. Please note that some products may not be available in all countries. Please always take note of the information that is provided with the product. For more detailed information, please consult with your contact partner or directly with Richard Wolf GmbH.

**ERAGON** modular

**MODULAR KNOT PUSHER Ø 5.0 MM, INSULATED**

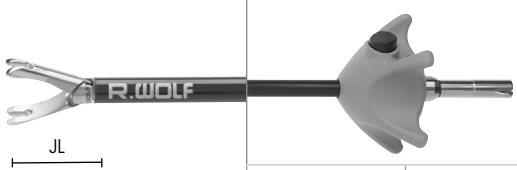
		Handle, axial			
 All jaw inserts and sheath tubes can also be combined with <b>ERAGONaxial</b>					
		with lock	without lock, with HF connector	without lock, with HF connector	with lock, not rotatable
<b>Rotatable knob</b>	<b>Product no.</b>	83930082	83930083	83930084	83930085
	8988	•	•	•	•

Jaw insert		Sheath tube, Ø 5.0 mm, insulated		Handle	Complete instrument • Jaw insert with sheath tube • Handle	
  JL		SL 330 mm	SL 450 mm	 with lock, without HF		
	JL*	<b>Product no.</b>	8393933	8394933	83930072	<b>Product no.</b>
<b>Knot pusher Ø 5 mm bndl</b>	17 mm	8393.345	•		•	<b>83933457</b>
with distal recess, double-action		8394345		•	•	<b>83943457</b>

KNOT PUSHER

11



\* JL = jaw length when jaw section closed (approximate measurements)

HF connection cable: see sheet BDE116/117

1123 || Subject to modifications. Please note that some products may not be available in all countries. Please always take note of the information that is provided with the product. For more detailed information, please consult with your contact partner or directly with Richard Wolf GmbH.

# KNOT PUSHER 5 MM FOR ENDOSCOPIC SUTURING



		Outer Ø	WL	TL	Product no.
	<b>Knot pusher Ø 3.7 mm WL 330 mm</b> for intraabdominal knots	3.7 mm	330 mm	380 mm	<b>8383.55</b>
	<b>Knot pusher Ø 3.7 mm WL 330 mm</b> for extracorporeal knots	3.7 mm	330 mm	380 mm	<b>8383.551</b>





		Outer Ø	WL	TL	Product no.
	<b>Knot pusher Ø 5 mm WL 330 mm</b> as per Bueß with distal notch and lateral opening for optimum knotting, extremely atraumatic tip for use as a surgical probe	5.0 mm	330 mm	380 mm	<b>8383.552</b>

|||23 || Subject to modifications. Please note that some products may not be available in all countries. Please always take note of the information that is provided with the product. For more detailed information, please consult with your contact partner or directly with Richard Wolf GmbH.

# Endoscopically controlled fascia closure system







## AS PER BUSCHE



				Product no.
 <p>for subcutaneous fascia suture</p>	Sealing cone Ø 10–12 mm			8934.915
	Sealing cone Ø 12–15 mm			8943.915
	Sealing cone Ø 15–20 mm			8945.915
		Ø	WL	Product no.
 <p>Needle forceps with active suture holder</p>	Needle forceps Ø 2.45 mm WL 160 mm	2.45 mm	160 mm	8756.201

11123 || Subject to modifications. Please note that some products may not be available in all countries. Please always take note of the information that is provided with the product. For more detailed information, please consult with your contact partner or directly with Richard Wolf GmbH.

## CANNULAS 3.0 MM/4.7 MM

				
<b>with Luer connector</b>		<b>Outer Ø</b>	<b>WL</b>	<b>Product no.</b>
 Tip Ø 1.4 mm	<b>Injection cannula Ø 3 mm WL 340 mm</b>	3.0 mm	340 mm	<b>8379.732</b>
				
<b>with 3 mm Luer connector</b>		<b>Ø</b>	<b>WL</b>	<b>Product no.</b>
 Tip Ø 1.8 mm	<b>Injection cannula Ø 4.7 mm WL 350 mm</b>	4.7 mm	350 mm	<b>8383.65</b>
				
<b>with suction regulator and 4 mm Luer connector</b>		<b>Ø</b>	<b>WL</b>	<b>Product no.</b>
 Tip Ø 1.8 mm	<b>Puncture cannula Ø 4.7 mm WL 320 mm</b>	4.7 mm	320 mm	<b>8383.49</b>
<b>for this:</b>		<b>WL</b>	<b>Product no.</b>	
	<b>Introduction sleeve size 5.5 mm WL 45 mm</b>  This sleeve prevents damage to the cannula tip when the trocar sleeve valve is opened	45 mm	<b>8383.00</b>	



# SURGICAL PROBES





		Ø	WL	Product no.
	<b>Surgical probe 3.5 mm WL 250 mm graduated</b>	3.5 mm	250 mm	<b>8379.672</b>



		Ø	WL	Product no.
	<b>Surgical probe Ø 5 mm WL 328 mm graduated</b>	5.0 mm	328 mm	<b>8383.66</b>
	<b>Surgical probe Ø 5 mm WL 448 mm graduated</b>	5.0 mm	448 mm	<b>8384.66</b>

# MYOMA DRILL 5 MM/10 MM



		Ø	WL	Product no.
	Myoma drill Ø 5 mm WL 320 mm	5 mm	320 mm	<b>8383.611</b>
	Myoma drill Ø 10 mm	10 mm	340 mm	<b>8385.301</b>

III23 || Subject to modifications. Please note that some products may not be available in all countries. Please always take note of the information that is provided with the product. For more detailed information, please consult with your contact partner or directly with Richard Wolf GmbH.

# INSUFFLATOR HIGHFLOW 45 BASIC



		Product no.
<b>Insufflator 45 BASIC bndI</b> consisting of: Insufflator 45 BASIC FR 45 l/min (2235001), Insufflation tube set L 2.5 m (8170.101), Hygiene filter, sterile, disposable (PACK= 10 PCS) (4171.111) and power cable 3 m long (2440.03)		<b>22350011</b>
<b>Accessories: Tube sets for insufflation</b>		
Insufflation tube set L 2.5 m, High Flow, D = 8 mm, autoclavable		<b>8170.232</b>
Insufflation tube set L 2.5 m, autoclavable		<b>8170.101</b>
Insufflation tube set L 2.7 m, with integrated hygiene filter, disposable, (PACK= 10 PCS) in individual sterile packaging		<b>4170.501</b>
Hygiene filter, sterile, disposable (PACK= 10 PCS) in individual sterile packaging		<b>4171.111</b>
<b>Accessories for gas supply</b>		
CO <sub>2</sub> connection tube 1.5 m NIST-NIST		<b>74021038</b>
with		
Pressure reducer for CO <sub>2</sub> connector DIN 477-1	DIN 477-1	<b>74007054</b>
Pressure reducer for CO <sub>2</sub> connector DIN EN ISO 407	DIN EN ISO 407	<b>74007055</b>
Pressure reducer for CO <sub>2</sub> connector ISO 5145	ISO 5145	<b>74007056</b>
or		
Connection tube for CO <sub>2</sub> 5.0 m DIN for centralized CO <sub>2</sub> gas supply (Dräger)		<b>74021039</b>
Connection tube for CO <sub>2</sub> 5.0 m NF for centralized CO <sub>2</sub> gas supply (Liquid Air)		<b>74021040</b>
<b>Software modules (optional)</b>		
Software module CAN bus CAN bus interface for integration in CORE		<b>2235101</b>
Software module BABY MODE BABY MODE for special use in pediatrics		<b>2235102</b>
Software module VIDEO DISPLAY: video display using DIALOG via CAN bus		<b>2235103</b>

# TECHNICAL DATA

## INSUFFLATOR HIGHFLOW 45 BASIC

Insufflator 45 BASIC		2235001
<b>Device properties</b>		
Operating mode	Continuous operation	
Operating conditions	+10°C to +40°C, 30% to 75% rel. humidity, atmospheric pressure 700 hPa to 1,060 hPa	
Storage and transport conditions	-20°C to +60°C, 10% to 90% rel. humidity, atmospheric pressure 700 hPa to 1,060 hPa	
<b>Power supply</b>		
Mains + frequency	100–240 V~, 50/60 Hz	
Power consumption	60 VA	
Current rating	0.6–0.2 A	
Fuse	T 3.15 AH 250 V	
<b>Regulatory standards</b>		
Protection class to IEC/EN 60601-1 (UL 60601-1/CSA C222 No6011 – for USA)	I	
Electromagnetic compatibility (EMC)	IEC/EN 60601-1-2	
Medical Devices Directive 93/42/EEC	Class IIb	
Protection against electric shock	Type CF applied part	
Degree of protection against the ingress of liquids	IP 20 (not protected)	
Degree of protection in the presence of flammable mixtures	Device is not protected against explosions (do not operate this device in explosive atmospheres)	
<b>Dimensions and weights</b>		
Weight	8.9 kg (19.5 lbs)	
Dimensions (W x H x D)	300 mm x 160 mm x 455 mm	

Relevant application parameters	
Insufflation medium	Medical-grade CO <sub>2</sub> (degree of purity > 99.5%)
Intraabdominal pressure	3 mmHg to 25 mmHg (± 2 mmHg) selectable in increments of 1 mmHg
Gas flow rate primary filling	1 l/min (± 50%)
Gas flow rate, High Flow	2 l/min to 45 l/min (± 20%) selectable in increments of 1 l/min
Consumption indicator	0 l to 9,999 l (± 20%)

# INSUFFLATOR HIGHFLOW 45 EVAC WITH SMOKE GAS EVACUATION



		Product no.
<b>Insufflator 45 EVAC bndl</b> consisting of: Insufflator 45 EVAC FR 45 l/min (2235011), Insufflation tube set L 2.5 m (8170.101), Hygiene filter, sterile, disposable (PACK= 10 PCS) (4171.111), Insufflation tube set L 2.7 m with integrated hygiene filter, sterile, disposable (PACK= 10 PCS) (4170.501) Smoke gas evacuation tube set L 2.7 m, sterile, disposable (PACK= 10 PCS) (4170503) Footswitch with 1 pedal (20301031) and power cable, 3 m long (2440.03)		<b>22350111</b>
<b>Accessories: Tube sets for insufflation</b>		
Smoke gas evacuation tube set L 2.7 m, sterile, disposable (PACK= 10 PCS)		<b>4170503</b>
<b>Accessories for gas supply</b>		
CO <sub>2</sub> connection tube 1.5 m NIST-NIST		<b>74021038</b>
with		
Pressure reducer for CO <sub>2</sub> connector DIN 477-1	DIN 477-1	<b>74007054</b>
Pressure reducer for CO <sub>2</sub> connector DIN EN ISO 407	DIN EN ISO 407	<b>74007055</b>
Pressure reducer for CO <sub>2</sub> connector ISO 5145	ISO 5145	<b>74007056</b>
or		
Connection tube for CO <sub>2</sub> 5.0 m DIN for centralized CO <sub>2</sub> gas supply (Dräger)		<b>74021039</b>
Connection tube for CO <sub>2</sub> 5.0 m NF for centralized CO <sub>2</sub> gas supply (Liquid Air)		<b>74021040</b>
<b>Software modules (optional)</b>		
Software module CAN bus CAN bus interface for integration in CORE		<b>2235101</b>
Software module BABY MODE BABY MODE for special use in pediatrics		<b>2235102</b>
Software module VIDEO DISPLAY: video display using DIALOG via CAN bus		<b>2235103</b>

# TECHNICAL DATA

## INSUFFLATOR HIGHFLOW 45 EVAC

Insufflator 45 EVAC		2235011
<b>Device properties</b>		
Operating mode	Continuous operation	
Operating conditions	+10°C to +40°C, 30% to 75% rel. humidity, atmospheric pressure 700 hPa to 1,060 hPa	
Storage and transport conditions	-20°C to +60°C, 10% to 90% rel. humidity, atmospheric pressure 700 hPa to 1,060 hPa	
<b>Power supply</b>		
Mains + frequency	100–240 V~, 50/60 Hz	
Power consumption	60 VA	
Current rating	0.6–0.2 A	
Fuse	T 3.15 AH 250 V	
<b>Regulatory standards</b>		
Protection class to IEC/EN 60601-1 (UL 60601-1/CSA C222 No6011 – for USA)	I	
Electromagnetic compatibility (EMC)	IEC/EN 60601-1-2	
Medical Devices Directive 93/42/EEC	Class IIb	
Protection against electric shock	Type CF applied part	
Degree of protection against the ingress of liquids	IP 20 (not protected)	
Degree of protection in the presence of flammable mixtures	Device is not protected against explosions (do not operate this device in explosive atmospheres)	
<b>Dimensions and weights</b>		
Weight	8.9 kg (19.5 lbs)	
Dimensions (W x H x D)	300 mm x 160 mm x 455 mm	

Relevant application parameters	
Insufflation medium	Medical-grade CO <sub>2</sub> (degree of purity > 99.5%)
Intraabdominal pressure	3 mmHg to 25 mmHg (± 2 mmHg) selectable in increments of 1 mmHg
Gas flow rate primary filling	1 l/min (± 50%)
Gas flow rate, High Flow	2 l/min to 45 l/min (± 20%) selectable in increments of 1 l/min
Consumption indicator	0 l to 9,999 l (± 20%)

# INSUFFLATOR HIGHFLOW 45 HEAT WITH GAS HEATING



		Product no.
<b>Insufflator 45 HEAT bndI</b> consisting of: Insufflator 45 HEAT FR 45 L/min(2235021), Insufflation tube for 2235021/031 L 3 m (8170202) Hygiene filter, sterile, disposable (PACK= 10 PCS) (4171.111) and power cable 3 m long (2440.03)		<b>22350211</b>
<b>Accessories: Tube sets for insufflation</b>		
<b>Insufflation tube set L 3 m</b> Highflow, with heating wire and integrated hygiene filter, sterile, disposable, (PACK= 10 PCS) in individual sterile packaging		<b>4170502</b>
<b>Insufflation tube for 2235021/031 L 3 m</b> Highflow, with heating wire, autoclavable, 3.0 m The reusable tube can be used up to 100 times		<b>8170202</b>
<b>Hygiene filter</b> , sterile, disposable (PACK= 10 PCS) in individual sterile packaging		<b>4171.111</b>
<b>Accessories for gas supply</b>		
<b>CO<sub>2</sub> connection tube 1.5 m NIST-NIST</b>		<b>74021038</b>
with		
<b>Pressure reducer for CO<sub>2</sub> connector DIN 477-1</b>	DIN 477-1	<b>74007054</b>
<b>Pressure reducer for CO<sub>2</sub> connector DIN EN ISO 407</b>	DIN EN ISO 407	<b>74007055</b>
<b>Pressure reducer for CO<sub>2</sub> connector ISO 5145</b>	ISO 5145	<b>74007056</b>
or		
<b>Connection tube for CO<sub>2</sub> 5.0 m DIN</b> for centralized CO <sub>2</sub> gas supply (Dräger)		<b>74021039</b>
<b>Connection tube for CO<sub>2</sub> 5.0 m NF</b> for centralized CO <sub>2</sub> gas supply (Liquid Air)		<b>74021040</b>
<b>Software modules (optional)</b>		
<b>Software module CAN bus</b> CAN bus interface for integration in CORE		<b>2235101</b>
<b>Software module BABY MODE</b> BABY MODE for special use in pediatrics		<b>2235102</b>
<b>Software module VIDEO DISPLAY:</b> video display using DIALOG via CAN bus		<b>2235103</b>

# TECHNICAL DATA

## INSUFFLATOR HIGHFLOW 45 HEAT

Insufflator 45 HEAT		2235021
<b>Device properties</b>		
Operating mode	Continuous operation	
Operating conditions	+10°C to +40°C, 30% to 75% rel. humidity, atmospheric pressure 700 hPa to 1,060 hPa	
Storage and transport conditions	-20°C to +60°C, 10% to 90% rel. humidity, atmospheric pressure 700 hPa to 1,060 hPa	
<b>Power supply</b>		
Mains + frequency	100–127/220–240 V~, 50/60 Hz	
Power consumption	80 VA	
Current rating	0.8–0.3 A	
Fuse	T 3.15 AH 250 V	
<b>Regulatory standards</b>		
Protection class to IEC/EN 60601-1 (UL 60601-1/CSA C222 No6011 – for USA)	I	
Electromagnetic compatibility (EMC)	IEC/EN 60601-1-2	
Medical Devices Directive 93/42/EEC	Class IIb	
Protection against electric shock	Type CF applied part	
Degree of protection against the ingress of liquids	IP 20 (not protected)	
Degree of protection in the presence of flammable mixtures	Device is not protected against explosions (do not operate this device in explosive atmospheres)	
<b>Dimensions and weights</b>		
Weight	11.0 kg (23.3 lbs)	
Dimensions (W x H x D)	300 mm x 160 mm x 455 mm	
<b>Relevant application parameters</b>		
Insufflation medium	Medical-grade CO <sub>2</sub> (degree of purity > 99.5%)	
Intraabdominal pressure	3 mmHg to 25 mmHg (± 2 mmHg) selectable in increments of 1 mmHg	
Gas flow rate primary filling	1 l/min (± 50%)	
Gas flow rate, High Flow	2 l/min to 45 l/min (± 20%) selectable in increments of 1 l/min	
Consumption indicator	0 l to 9,999 l (± 20%)	



# INSUFFLATOR HIGHFLOW 45 EVAC + HEAT

## WITH SMOKE GAS EVACUATION AND GAS HEATING



		Product no.
<b>Insufflator 45 EVAC + HEAT bndl</b>		
consisting of: Insufflator 45 EVAC + HEAT FR 45 l/min(2235031), Insufflation tube for 2235021/031 L 3 m (8170202), Insufflation tube set L 3 m, sterile, disposable, (PACK= 10 PCS) (4170502), Hygiene filter, sterile, disposable (PACK= 10 PCS) (4171.111), Smoke gas evacuation tube set L 2.7 m, sterile, disposable (PACK= 10 PCS) (4170503) Footswitch 1 pedal (20301031) and power cable 3 m long (2440.03)		<b>22350311</b>
<b>Accessories: Tube sets for insufflation</b>		
<b>Insufflation tube set L 3 m</b> Highflow, with heating wire and integrated hygiene filter, sterile, disposable, (PACK= 10 PCS) in individual sterile packaging		<b>4170502</b>
<b>Insufflation tube for 2235021/031 L 3 m</b> Highflow, with heating wire, autoclavable, 3.0 m <small>The reusable tube can be used up to 100 times</small>		<b>8170202</b>
<b>Hygiene filter</b> , sterile, disposable (PACK= 10 PCS) in individual sterile packaging		<b>4171.111</b>
<b>Smoke gas evacuation tube set L 2.7 m</b> , sterile, disposable (PACK= 10 PCS)		<b>4170503</b>
<b>Accessories for gas supply</b>		
<b>CO<sub>2</sub> connection tube 1.5 m NIST-NIST</b>		<b>74021038</b>
with		
<b>Pressure reducer for CO<sub>2</sub> connector DIN 477-1</b>	DIN 477-1	<b>74007054</b>
<b>Pressure reducer for CO<sub>2</sub> connector DIN EN ISO 407</b>	DIN EN ISO 407	<b>74007055</b>
<b>Pressure reducer for CO<sub>2</sub> connector ISO 5145</b>	ISO 5145	<b>74007056</b>
or		
<b>Connection tube for CO<sub>2</sub> 5.0 m DIN</b> for centralized CO <sub>2</sub> gas supply (Dräger)		<b>74021039</b>
<b>Connection tube for CO<sub>2</sub> 5.0 m NF</b> for centralized CO <sub>2</sub> gas supply (Liquid Air)		<b>74021040</b>
<b>Software modules (optional)</b>		
<b>Software module CAN bus</b> CAN bus interface for integration in CORE		<b>2235101</b>
<b>Software module BABY MODE</b> BABY MODE for special use in pediatrics		<b>2235102</b>
<b>Software module VIDEO DISPLAY:</b> video display using DIALOG via CAN bus		<b>2235103</b>

# TECHNICAL DATA

## INSUFFLATOR HIGHFLOW 45 EVAC + HEAT

Insufflator 45 EVAC + HEAT		2235031
<b>Device properties</b>		
Operating mode	Continuous operation	
Operating conditions	+10°C to +40°C, 30% to 75% rel. humidity, atmospheric pressure 700 hPa to 1,060 hPa	
Storage and transport conditions	-20°C to +60°C, 10% to 90% rel. humidity, atmospheric pressure 700 hPa to 1,060 hPa	
<b>Power supply</b>		
Mains + frequency	100–127/220–240 V~, 50/60 Hz	
Power consumption	80 VA	
Current rating	0.8–0.3 A	
Fuse	T 3.15 AH 250 V	
<b>Regulatory standards</b>		
Protection class to IEC/EN 60601-1 (UL 60601-1/CSA C222 No6011 – for USA)	I	
Electromagnetic compatibility (EMC)	IEC/EN 60601-1-2	
Medical Devices Directive 93/42/EEC	Class IIb	
Protection against electric shock	Type CF applied part	
Degree of protection against the ingress of liquids	IP 20 (not protected)	
Degree of protection in the presence of flammable mixtures	Device is not protected against explosions (do not operate this device in explosive atmospheres)	
<b>Dimensions and weights</b>		
Weight	11.0 kg (23.3 lbs)	
Dimensions (W x H x D)	300 x 160 x 455 mm	

Relevant application parameters	
Insufflation medium	Medical-grade CO <sub>2</sub> (degree of purity > 99.5%)
Intraabdominal pressure	3 mmHg to 25 mmHg (± 2 mmHg) selectable in increments of 1 mmHg
Gas flow rate primary filling	1 l/min (± 50%)
Gas flow rate, High Flow	2 l/min to 45 l/min (± 20%) selectable in increments of 1 l/min
Consumption indicator	0 l to 9,999 l (± 20%)

# LAPARO-CO<sub>2</sub>-PNEU 2233



		Product no.
<b>LAPARO-CO<sub>2</sub>-PNEU bndl</b> consisting of: LAPARO-CO2-PNEU 2233 FR 20 L/MIN (2233.001) Insufflation tube set L 2.5 m (8170.101), Hygiene filter, sterile, disposable (PACK= 10 PCS) (4171.111), and power cable 3 m long (2440.03)		<b>22330011</b>
<b>Accessories: Tube sets for insufflation</b>		
<b>Insufflation tube set, L 2.7 m</b> with integrated hygiene filter, sterile, disposable, (PACK= 10 PCS) in individual sterile packaging		<b>4170.501</b>
<b>Accessories for gas supply</b>		
<b>CO<sub>2</sub> connection tube 1.5 m NIST-NIST</b>		<b>74021038</b>
with		
<b>Pressure reducer for CO<sub>2</sub> connector DIN 477-1</b>	DIN 477-1	<b>74007054</b>
<b>Pressure reducer for CO<sub>2</sub> connector DIN EN ISO 407</b>	DIN EN ISO 407	<b>74007055</b>
<b>Pressure reducer for CO<sub>2</sub> connector ISO 5145</b>	ISO 5145	<b>74007056</b>
or		
<b>Connection tube for CO<sub>2</sub> 5.0 m DIN for centralized CO<sub>2</sub> gas supply (Dräger)</b>		<b>74021039</b>
<b>Connection tube for CO<sub>2</sub> 5.0 m NF for centralized CO<sub>2</sub> gas supply (Liquid Air)</b>		<b>74021040</b>



# TECHNICAL DATA

## LAPARO-CO<sub>2</sub>-PNEU 2233

LAPARO-CO <sub>2</sub> -PNEU 2233		2233.001
<b>Device properties</b>		
Operating mode	Continuous operation	
Operating conditions	+10°C to +40°C, 30% to 75% rel. humidity, atmospheric pressure 700 hPa to 1,060 hPa	
Storage and transport conditions	-20°C to +60°C, 10% to 90% rel. humidity, atmospheric pressure 700 hPa to 1,060 hPa	
<b>Power supply</b>		
Mains + frequency	100–230 V~, 50/60 Hz	
Power consumption	80 VA	
Current rating	0.8 A	
Fuse	T 2 AL 250 V	
<b>Regulatory standards</b>		
Protection class to IEC/EN 60601-1 (UL 60601-1/CSA C222 No6011 – for USA)	I	
Electromagnetic compatibility (EMC)	EN/IEC 60601--1--2	
Medical Devices Directive 93/42/EEC	Class IIb	
Protection against electric shock	Type CF applied part	
Degree of protection against the ingress of liquids	IP 20 (not protected)	
Degree of protection in the presence of flammable mixtures	Device is not protected against explosions (do not operate this device in explosive atmospheres)	
Maximum suction vacuum	-60 kPa	
<b>Dimensions and weights</b>		
Weight	9.5 kg	
Dimensions (W x H x D)	330 mm x 155 mm x 390 mm	

Relevant application parameters	
Insufflation medium	Medical-grade CO <sub>2</sub> (degree of purity > 99.5%)
Intraabdominal pressure	3 mmHg to 25 mmHg (± 2 mmHg) selectable in increments of 1 mmHg
Gas flow rate primary filling	1 l/min (± 50%)
Gas flow rate, High Flow	2 l/min to 20 l/min (± 20%) selectable in increments of 1 l/min
Consumption indicator	0 l to 9,999 l (± 20%)

## STERILE SMOKE SET FOR SMOKE GAS DISCHARGE

 	
<b>Product no.</b>	
<p><b>Smoke set</b> smoke filter with tube (PACK= 10 PCS) in individual sterile packaging</p>	<p><b>2200/47BDKBTUA123</b></p>

||24|| Subject to modifications. Please note that some products may not be available in all countries. Please always take note of the information that is provided with the product. For more detailed information, please consult with your contact partner or directly with Richard Wolf GmbH.

# FLUID CONTROL 2225

## SUCTION IRRIGATION PUMP

core



		Product no.
FLUID CONTROL 2225 <b>Irrigation pump for Hys/Uro/Lap bndl</b> consisting of: Irrigation pump for Hys/Uro/Lap (2225001) and power cable 3 m long (2440.03)		<b>22250011</b>
<b>for this:</b>		
<b>Balancing module</b> for hysteroscopy and endourology, fluid management for fluid balancing in combination with FLUID CONTROL 2225, mobile stand with integrated weighing cells and space for up to 4 irrigation fluid bags		<b>2225023</b>

Accessories		Product no.
<b>Footswitch</b>	only for use in urology and within the indication TUR/enucleation, possibility of short-term increase in pressure if visibility is poor (Flush function)	<b>2204901</b>

III23 || Subject to modifications. Please note that some products may not be available in all countries. Please always take note of the information that is provided with the product. For more detailed information, please consult with your contact partner or directly with Richard Wolf GmbH.

# FLUID CONTROL 2225

## SUCTION IRRIGATION TUBE SETS

Irrigation			Product no.
<b>Accessories – reusable</b>	<b>Tube set with piercing spike</b>	with Luer-Lock connection, autoclavable, incl. 10 spare membranes, reusable for 20 reprocessing cycles	<b>8171223</b>
<b>Accessories – disposable</b>	<b>Irrigation tube set with piercing spike, L 3 m</b>	(PACK= 10 PCS), with Luer-Lock connection, sterile, disposable product	<b>4171223</b>
	<b>Tube set with CARE-LOCK, L 3 m</b>	(PACK= 10 PCS), sterile, disposable product	<b>4171224</b>
	<b>Suction irrigation tube set</b>	(PACK= 10 PCS), with piercing spike, sterile disposable product, PVC	<b>4171225</b>
	<b>Day irrigation tube set</b>	(PACK= 10 PCS), sterile, disposable product, PVC	<b>4171226</b>
	<b>Patient irrigation tube set, sterile</b>	(PACK= 10 PCS), with Luer-Lock connection, sterile, disposable product, PVC	<b>4171227</b>
<i>Note: Day tube and patient tube can only be used together. A new patient tube is required for each patient; the day tube can be used for up to 20 patients</i>			

Suction			Product no.
<b>Accessories – reusable</b>	<b>Tube set for vacuum, incl. filter</b>	with integrated hygiene filter, PACK= 10 PCS, service life: 30 days (connected to irrigation pump)	<b>2206207</b>
	<b>Irrigation tube</b>	L 1.2 m, with Luer-Lock, for suction irrigation handle 8385.901 and tube set 8171223 or 8170.223	<b>817123</b>
	<b>Suction tube L 3 m</b>	for suction irrigation handle 8385.901	<b>8171402</b>
	<b>Secretion container, 2 l</b>	2 liters, with lid	<b>8170.655</b>
	<b>Secretion container, 2 l</b>	2 liters, no lid	<b>8170.6551</b>
<b>Accessories – disposable</b>	<b>Secretion container, 2.5 l</b>	2.5 liters	<b>41706566</b>
	<b>Secretion container bndl consisting of:</b>	Secretion container 2.5 l (41706566) and secretion bag (PACK= 90 PCS) (41706564)	<b>4170657</b>
	<b>Tube set for suction (2 connections)</b>	sterile, disposable product, (PACK= 10 PCS) for connecting instruments to collecting container	<b>T0503-01</b>
	<b>Angled 90° plug-in coupling</b>	(PACK= 10 PCS) For connecting vacuum tube 2206207 to disposable container systems	<b>0771019</b>

# FLUID CONTROL 2225

## CABLE ACCESSORIES

		Product no.
Patch cable, RJ45 SFTP, 0.5 m	Cable length 0.5 m	<b>72325378</b>
Patch cable, RJ45 HRS TM11, 1.0 m	Cable length 1.0 m	<b>72325429</b>
Patch cable, RJ45 S/FTP CAT6 10 m	Cable length 10 m	<b>72325434</b>
Plastic caps for network socket	(PACK= 8 PCS)	<b>5592105</b>
Power cable	Cable length 3 m	<b>2440.03</b>

III23 || Subject to modifications. Please note that some products may not be available in all countries. Please always take note of the information that is provided with the product. For more detailed information, please consult with your contact partner or directly with Richard Wolf GmbH.



# TECHNICAL DATA

## FLUID CONTROL 2225

FLUID CONTROL 2225		2225001
<b>Device properties</b>		
Operating conditions		+10°C to +40°C, 30% to 75% rel. humidity, 70 to 106 kPa atmospheric pressure 3,000 m max. altitude above sea level
Storage and transport conditions		-20°C to +60°C, 10% to 90% rel. humidity 70 to 106 kPa atmospheric pressure
<b>Power supply</b>		
Mains + frequency		100–240 V~, 50/60 Hz
Power consumption	100 V/60 Hz	110 VA
	240 V/50 Hz	120 VA
Current rating	100 V/60 Hz	1.10 A
	240 V/50 Hz	0.50 A
Fuse		T 3.15 AH, 250 V
<b>Regulatory standards</b>		
Protection class (I, II)		I
Electromagnetic compatibility (EMC)		EN 60601-1/IEC 60601-1 EN 60601-1-2/IEC 60601-1-2
Medical Devices Directive 93/42/EEC		Class IIb
Housing protection rating (IP code)		IP21
Protection against electric shock		Type BF applied part
Degree of protection in the presence of flammable mixtures		Device is not protected against explosions (do not operate this device in explosive atmospheres)
Maximum suction vacuum		-60 kPa
<b>Dimensions and weights</b>		
Weight		8.8 kg
Dimensions (W x H x D)		300 mm x 157 mm x 436 mm
<b>Relevant application parameters</b>		
Nominal flow range		Hysteroscopy: 800 ml/min (max. flow, not adjustable) Endourology: 10–800 ml/min (max. flow) Laparoscopy: 0.1–1.8 l/min (max. flow)
Suction power		max. 2 l/min
Starting nominal pressure range		Hysteroscopy: 15–200 mmHg Endourology: 15–90 mmHg/20–120 cmH2O Laparoscopy: 300 mmHg (not adjustable)
Pressure		0–300 mmHg
Deficit		-9,990 to +9,990 ml/0 to 99.9 l

# TECHNICAL DATA

## FLUID CONTROL 2225

<b>Balancing module</b>		<b>2225023</b>
<b>Device properties</b>		
Operating conditions	+10°C to +40°C, 30% to 75% rel. humidity, 70 to 106 kPa atmospheric pressure 3,000 m max. altitude above sea level	
Storage and transport conditions	-20°C to +60°C , 10% to 90% rel. humidity 70 to 106 kPa atmospheric pressure	
<b>Regulatory standards</b>		
Electromagnetic compatibility (EMC)	EN 60601-1/IEC 60601-1 EN 60601-1-2/IEC 60601-1-2	
Housing protection rating (IP code)	IP21	
Maximum load of container scale	16 kg/4 containers of 3 l each	
Maximum load of bag scale	23 kg/4 bags of 5 l each	
<b>Dimensions and weights</b>		
Weight	15.4 kg	
Dimensions (W x H x D)	618 mm x 1,064 mm x 618 mm	

<b>Footswitch</b>		<b>2204901</b>
<b>Power supply</b>		
Power supply connection	max. 24 V	
Power consumption	max. 0.1 A	
<b>Regulatory standards</b>		
Electromagnetic compatibility (EMC)	EN 60601-1/IEC 60601-1	
Housing protection rating (IP code)	IPX8	
Plug	7-pin circular connector	
Cable length	4.5 m	
<b>Dimensions and weights</b>		
Weight	300 g	
Dimensions (W x H x D)	66 mm x 27 mm x 91 mm	

# FLUID CONTROL LAP 2216

	
<b>Product no.</b>	
<p>FLUID CONTROL  <b>LAP suction irrigation pump bndl</b>                  consisting of:                  LAP suction irrigation pump (2216001)                  and power cable 3 m long (2440.03)</p>	<b>22160011</b>

<b>Accessories</b>		<b>Product no.</b>
<b>Bracket</b>	for fixing the suction container on the irrigator stand or MUT cart	<b>2215.992</b>
<b>Universal holder</b>	for FLUID CONTROL LAP on RIWomobil	<b>32114605</b>

11123 || Subject to modifications. Please note that some products may not be available in all countries. Please always take note of the information that is provided with the product. For more detailed information, please consult with your contact partner or directly with Richard Wolf GmbH.

# LAP SUCTION IRRIGATION PUMP 2216

## SUCTION IRRIGATION TUBE SETS

Irrigation			Product no.
Accessories – reusable	Tube set with piercing spike	with Luer-Lock connection, autoclavable, incl. 10 spare membranes, reusable for 20 reprocessing cycles	<b>8171223</b>
	Irrigation tube set with piercing spike, L 3 m	(PACK= 10 PCS), with Luer-Lock connection, sterile, disposable product	<b>4171223</b>
Accessories – disposable	Tube set with CARE-LOCK, L 3 m	(PACK= 10 PCS), sterile, disposable product	<b>4171224</b>
	Suction irrigation tube set	(PACK= 10 PCS), with piercing spike, sterile disposable product, PVC	<b>4171225</b>
	Day irrigation tube set	(PACK= 10 PCS), sterile, disposable product, PVC	<b>4171226</b>
	Patient irrigation tube set, sterile	(PACK= 10 PCS), with Luer-Lock connection, sterile, disposable product, PVC	<b>4171227</b>
<i>Note: Day tube and patient tube can only be used together. A new patient tube is required for each patient; the day tube can be used for up to 20 patients</i>			

Suction			Product no.
Accessories – reusable	Tube set for vacuum, incl. filter	with integrated hygiene filter, PACK= 10 PCS, service life: 30 days (connected to irrigation pump)	<b>2206207</b>
	Irrigation tube	L 1.2 m, with Luer-Lock, for suction irrigation handle 8385.901 and tube set 8171223 or 8170.223	<b>817123</b>
	Suction tube L 3 m	for suction irrigation handle 8385.901	<b>8171402</b>
	Secretion container, 2 l	2 liters, with lid	<b>8170.655</b>
	Secretion container, 2 l	2 liters, no lid	<b>8170.6551</b>
Accessories – disposable	Secretion container, 2.5 l	2.5 liters	<b>41706566</b>
	Secretion container bndl consisting of:	Secretion container 2.5 l (41706566) and secretion bag (PACK= 90 PCS) (41706564)	<b>4170657</b>
	Tube set for suction (2 connections)	sterile, disposable product, (PACK= 10 PCS) for connecting instruments to collecting container	<b>T0503-01</b>
	Angled 90° plug-in coupling	(PACK= 10 PCS) For connecting vacuum tube 2206207 to disposable container systems	<b>0771019</b>

# TECHNICAL DATA

## FLUID CONTROL LAP 2216

LAP suction irrigation pump		2216001
<b>Device properties</b>		
Operating conditions	+10°C to +40°C, 30% to 75% rel. humidity, atmospheric pressure 700 hPa to 1,060 hPa 3,000 m max. altitude above sea level	
Storage conditions	+5°C to +40°C, 5% to 90% rel. humidity, atmospheric pressure 700 hPa to 1,060 hPa	
Transport and shipping conditions	-20°C to +60°C, 5% to 90% rel. humidity, atmospheric pressure 700 hPa to 1,060 hPa	
<b>Power supply</b>		
Mains + frequency	100–240 V~, 50/60 Hz	
Power consumption	100 V/60 Hz	65 VA
	240 V/50 Hz	96 VA
Current rating	100 V/60 Hz	0.65 A
	240 V/50 Hz	0.42 A
Protection class	I	
Electromagnetic compatibility (EMC)	IEC 60601-1/EN 60601-1 IEC 60601-1-2/EN 60601-1-2	
Medical Devices Directive 93/42/EEC	Class IIa	
Protection against electric shock	Type BF applied part	
Degree of protection against the ingress of liquids	IP 41	
Degree of protection in the presence of flammable mixtures	Device is not protected against explosions (do not operate this device in explosive atmospheres)	
<b>Dimensions and weights</b>		
Weight	4 kg	
Dimensions (W x H x D) with toggle screw	140 mm x 210 mm x 295 mm	

Relevant application parameters	
Maximum delivery rate	Rinsing: 2.0 l/min (± 10%), suction: 2.0 l/min (+0.4/-0.1 l/min)
Maximum pump pressure	400 mmHg (± 50 mmHg)
Motor cut-out	500 mmHg after 5 s (± 25 mmHg)
Suction pressure	between -50 kPa and -60 kPa
Connections	Equipotential bonding, vacuum connection

# HF GENERATOR 2260

core

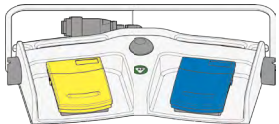

		Product no.
HF surgical generator 400 kHz	for the connection of monopolar and bipolar accessories, international version (BOWA, KLS Martin, Olympus, Karl Storz, Valleylab)	2260001
HF surgical generator 400 kHz	for the connection of monopolar and bipolar accessories, E version (Erbe)	2260002

Accessories required	Cable length	Product no.
<b>Footswitch, 2 pedals L 5 m</b> with fixed connection cable, reusable 		2260021
<b>Neutral electrode</b> for use with high-frequency surgical device, Foil bag with 5 neutral electrodes, (PACK= 50 PCS)		1280H
<b>Mono HF neutral electrode cable, L 4.5 m</b>	4.5 m	2260031
<b>Power cable</b>	3.0 m	2440.03
<b>Bipo HF connection cable L 3 m</b>	3.0 m	8108233
<b>Bipo HF connection cable L 5 m</b>	5.0 m	8108253







11123 || Subject to modifications. Please note that some products may not be available in all countries. Please always take note of the information that is provided with the product. For more detailed information, please consult with your contact partner or directly with Richard Wolf GmbH.

# HF GENERATOR 2260

## TECHNICAL DATA

HF surgical generator 400kHz		2260001/2260002
<b>Device properties</b>		
Type of controls on housing front		Touch panel
Output power	max.cutting power	400 W
	max.coagulation power	350 W
LF and HF leakage currents		acc. to DIN EN 60601 1 and DIN EN 60601 2 2
Signal level		HF indicator 55 dB(A); adjustable 45–60 dB(A) Alarm 65 dB(A)
Operating conditions		+10°C to +40°C, 30% to 75% rel humidity, 700 hPa to 1,060 hPa atmospheric pressure
Storage and transport conditions		- 20°C to + 60°C, 10% to 90% rel humidity, 700 hPa to 1,060 hPa atmospheric pressure
<b>Power supply</b>		
Mains + frequency		100–240 V~, 50/60 Hz
Power consumption	without HF output	45 VA
	at max. output power	650 VA
Current rating		max. 6.3 A
Fuse		T 6.3 AH 250 V
<b>Regulatory standards</b>		
Protection class to EN/IEC 60601-1 (UL 2601-1/CSA C222 No6011 – for USA)		I
Electromagnetic compatibility (EMC)		EN/IEC 60601-1-2
Medical Devices Directive 93/42/EEC		Class IIb
Degree of protection against the ingress of liquids (DIN EN/IEC 60529)		IPX0
Degree of protection against the ingress of solids		IP2X
Duty factor (duty cycle DC)		Intermittent INT 10 s/30 s corresponding to 25% DC
Protection against electric shock		Model CF applied part, defibrillator-proof
Degree of protection in the presence of flammable mixtures		Device is not protected against explosions (do not operate this device in explosive atmospheres)
<b>Dimensions and weights</b>		
Weight		10.2 kg (22.4 lbs)
Dimensions (W x H x D)		300 x 159 x 419 mm

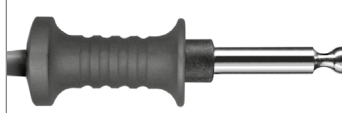
# HF CONNECTION CABLE MONO 815xxx

Instrument connector	Device connector		Product no.
<b>WOLF Resectoscopes</b> 	 ERBE (ACC/ICC/IO)/BOWA (EU) R. Wolf HF surgical generator 400 kHz 2260002	HF connection cable mono L 3 m	<b>815.032</b>
		HF connection cable mono L 5 m	<b>815.052</b>
	 ERBE (T series)	HF connection cable mono L 3 m	<b>815.132</b>
		HF connection cable mono L 5 m	<b>815.152</b>
<b>HF electrodes, monopolar</b> 	 Martin (M-version)/Berchtold/ Aesculap	HF connection cable mono L 3 m	<b>815.031</b>
		HF connection cable mono L 5 m	<b>815.051</b>
	 Bovie/Valleylab/Erbe (Int.)/ BOWA (Int.) R. Wolf HF surgical generator 400 kHz 2260001	HF connection cable mono L 3 m	<b>815.033</b>
		HF connection cable mono L 5 m	<b>815.053</b>
	 BOWA (Int./EU) Eschmann and other devices with 4 mm plugs R. Wolf HF surgical generator 400 kHz 2260001	HF connection cable mono L 3 m	<b>815.034</b>
		HF connection cable mono L 5 m	<b>815.054</b>

III23 || Subject to modifications. Please note that some products may not be available in all countries. Please always take note of the information that is provided with the product. For more detailed information, please consult with your contact partner or directly with Richard Wolf GmbH.











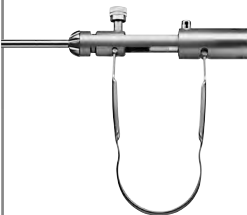

# HF CONNECTION CABLE MONO 8106xxx

Instrument connector	Device connector		Product no.
<b>WOLF Instruments/surgical generator</b> 		HF connection cable mono L 3 m	<b>8106.032</b>
	Erbe (ACC/ICC/VIO)/BOWA (EU) R. Wolf HF surgical generator 400 kHz 2260002	HF connection cable mono L 5 m	<b>8106.052</b>
		HF connection cable mono L 3 m	<b>8106.132</b>
	Erbe (T series)	HF connection cable mono L 5 m	<b>8106.152</b>
<b>HF electrodes, monopolar</b> 		HF connection cable mono L 3 m	<b>8106.031</b>
	Martin (M-version)/Berchold/ Aesculap	HF connection cable mono L 5 m	<b>8106.051</b>
		HF connection cable mono L 3 m	<b>8106.033</b>
	Bovie/Valleylab/Erbe (Int.)/ BOWA (Int.) R. Wolf HF surgical generator 400 kHz 2260001	HF connection cable mono L 5 m	<b>8106.053</b>
		HF connection cable mono L 3 m	<b>8106.034</b>
	BOWA (Int./EU) Eschmann and other devices with 4 mm plugs R. Wolf HF surgical generator 400 kHz 2260001/2260002	HF connection cable mono L 5 m	<b>8106.054</b>





# BIPO HF CONNECTION CABLE

8108xxx

Instrument connector	Device connector		Product no.	
<b>WOLF Bipolar forceps</b>  	 ERBE (ACC/ICC/T)/BOWA (EU) R. Wolf HF surgical generator 400 kHz 2260001/2260002	HF connection cable bipo; L 3 m	<b>8108.032</b>	
		HF connection cable bipo; L 5 m	<b>8108.052</b>	
	 International / 2-pin Valleylab R. Wolf HF surgical generator 400 kHz 2260001/2260002	HF connection cable bipo; L 3 m	<b>8108.033</b>	
		HF connection cable bipo; L 5 m	<b>8108.053</b>	
	 WOLF/Martin (M-version)/ Berchtold/Aesculap	HF connection cable bipo; L 3 m	<b>8108.031</b>	
		HF connection cable bipo; L 5 m	<b>8108.051</b>	
	 EMC Dolley	HF connection cable bipo; L 3 m	<b>8108035</b>	
	<b>Bipolar tweezers connection</b>  	 ERBE (ACC/ICC/T)/BOWA (EU) R. Wolf HF surgical generator 400 kHz 2260001/2260002	HF connection cable bipo; L 3 m	<b>8108.132</b>
			HF connection cable bipo; L 5 m	<b>8108.152</b>
		 International / 2-pin Valleylab R. Wolf HF surgical generator 400 kHz 2260001/2260002	HF connection cable bipo; L 3 m	<b>8108.133</b>
HF connection cable bipo; L 5 m			<b>8108.153</b>	
 Martin (M-version)/Berchtold/ Aesculap		HF connection cable bipo; L 3 m	<b>8108.131</b>	
		HF connection cable bipo; L 5 m	<b>8108.151</b>	
 EMC Dolley		HF connection cable bipo; L 3 m	<b>8108135</b>	

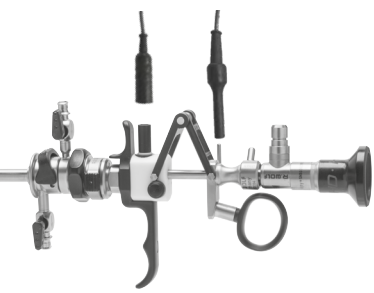

III23 || Subject to modifications. Please note that some products may not be available in all countries. Please always take note of the information that is provided with the product. For more detailed information, please consult with your contact partner or directly with Richard Wolf GmbH.

# HF CONNECTION CABLE BIPO FOR RESECTION IN SALINE SOLUTION

Instrument connector	Device connector		Product no.
<p><b>WOLF S(a)line resectoscopes</b></p> 	 Erbe VIO 300D	<p><b>Bipolar cable; TUR/TCR; WOLF</b></p> <p>MF plug; L 4 m</p>	<p><b>20196-119</b></p>
	 Erbe VIO 3	<p><b>BIPOLAR CABLE; MF-U</b></p> <p>MF plug; L 4.5 m</p>	<p><b>21196-119</b></p>
	 KLS Martin	<p><b>HF connection cable bipo; L 3 m</b></p>	<p><b>8108.231</b></p>
		<p><b>HF connection cable bipo; L 5 m</b></p>	<p><b>8108.251</b></p>
	 R. Wolf HF surgical generator 400 kHz 2260001/2260002		<p><b>8108233</b></p>
		<p><b>HF connection cable bipo; L 5 m</b></p>	<p><b>8108253</b></p>

11123 || Subject to modifications. Please note that some products may not be available in all countries. Please always take note of the information that is provided with the product. For more detailed information, please consult with your contact partner or directly with Richard Wolf GmbH.

# MONO HF NEUTRAL ELECTRODE CABLE

Instrument connector	Device connector		Product no.
<p><b>2-pole neutral electrode</b></p> 	 <p>R. Wolf HF surgical generator 400 kHz 2260001/2260002</p>	<p><b>Mono HF neutral electrode cable, L 4.5 m</b></p>	<p><b>2260031</b></p>

III23 || Subject to modifications. Please note that some products may not be available in all countries. Please always take note of the information that is provided with the product. For more detailed information, please consult with your contact partner or directly with Richard Wolf GmbH.

# FLEXIBLE FIBER CHOLEDOCHOSCOPE 5 MM CHANNEL 2.5 MM

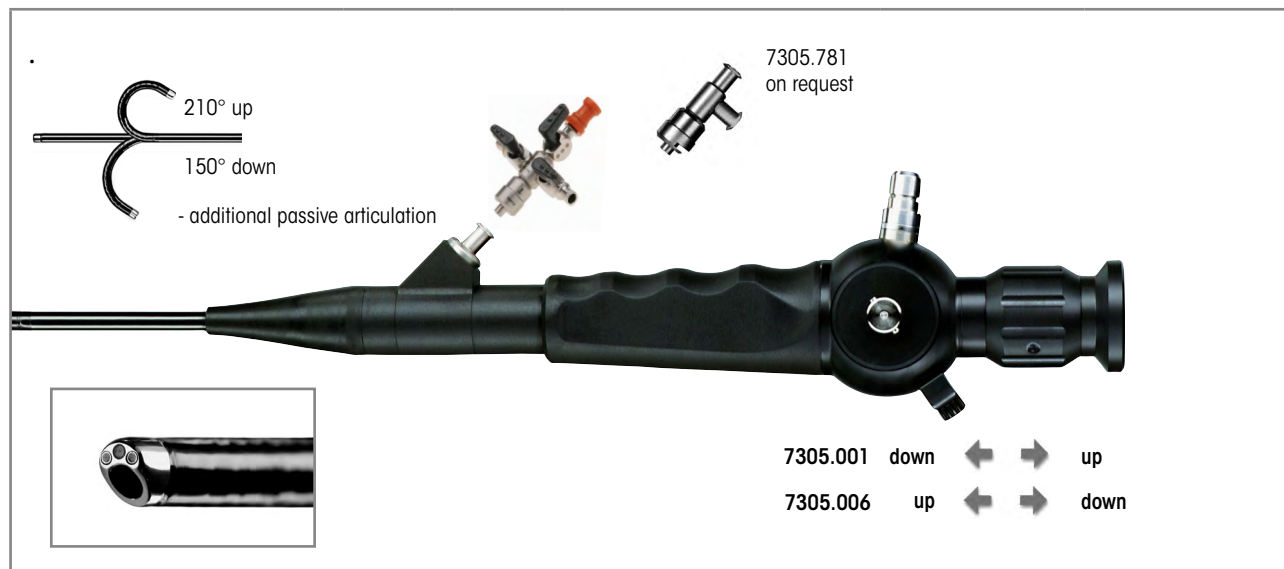

	Outer Ø	Working channel	WL	Control lever in distal direction – articulation downward	Control lever in distal direction – articulation upward	Product no.
<b>Fiber cystoscope 15 FR WL 400 mm</b> Slanted distal tip Articulation +210°/-150° Direction of view 0°, viewing angle 110°	5 mm 15 Fr	25 mm 75 Fr	400 mm	•		<b>7305.001</b>
					•	<b>7305.006</b>
<b>Fiber cystoscope bndl</b> consisting of: Fiber cystoscope 15 FR WL 400 mm (7305.001) Adapter with 2 irrigation valves and 1 instrument port (7305.782) Leakage tester for flex. endoscopes (163.903) Pressure equalization valve (163.904) Cleaning brush Ø 3 mm, TL 1,200 mm (PACK= 10 PCS) (7990002)				•		<b>730500111</b>
<b>Fiber cystoscope bndl</b> consisting of: Fiber cystoscope 15 FR WL 400 mm (7305.006) Adapter with 2 irrigation valves and 1 instrument port (7305.782) Leakage tester for flex. endoscopes (163.903) Pressure equalization valve (163.904) Cleaning brush Ø 3 mm, TL 1,200 mm (PACK= 10 PCS) (7990002)					•	<b>730500611</b>

Recommended accessories	Product no.
<b>Fiber light cable bndl</b> consisting of: Fiber light cable Ø 2.5 mm TL 2.3 m (80662523), projector-side adapter (8095.07), and endoscope-side adapter (809509)	Ø 2.5 mm, 2.3 m long <b>806625231</b>

11123 | Subject to modifications. Please note that some products may not be available in all countries. Please always take note of the information that is provided with the product. For more detailed information, please consult with your contact partner or directly with Richard Wolf GmbH.

**mamba**  
VISION

**FLEXIBLE SENSOR ENDOSCOPE FOR USE IN CHOLEDOCHOSCOPY**

FOR ENDOCAM **Logic 4K** CONTROLLER

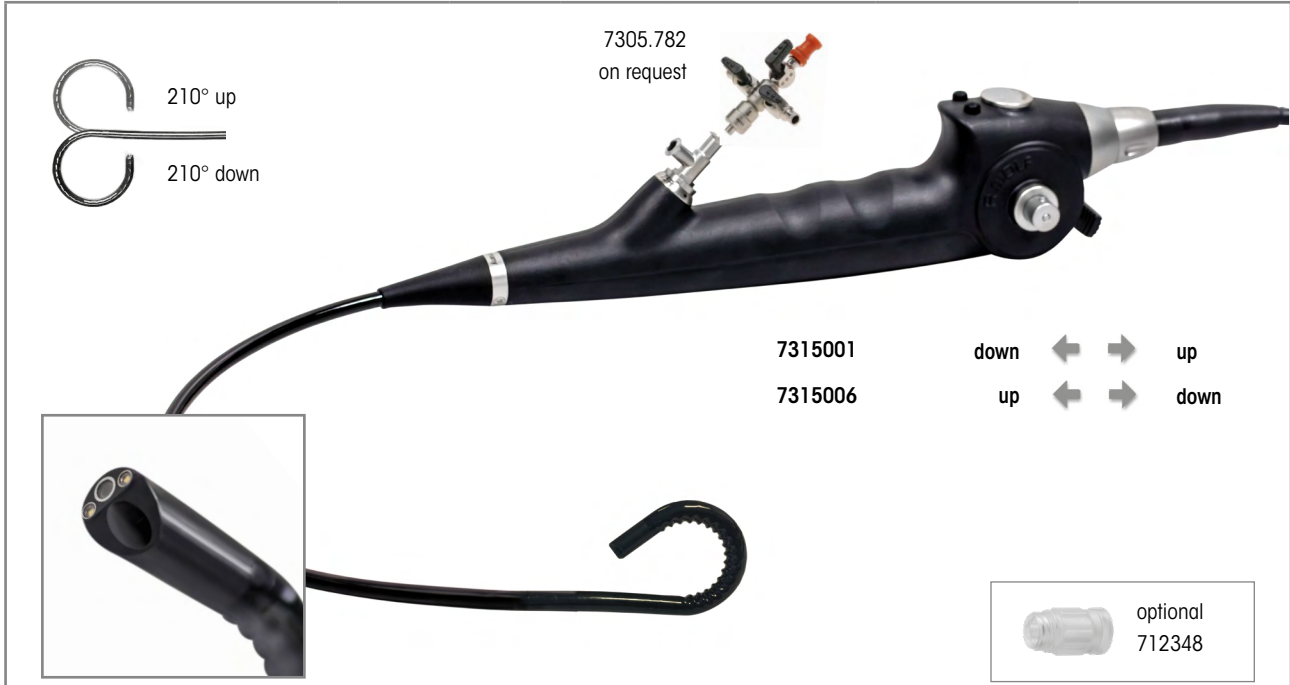

	Outer Ø	Working channel	WL	Control lever in distal direction – articulation downward	Control lever in distal direction – articulation upward	Product no.
<b>Sensor cystoscope</b> <b>16.2 Fr WL 400 mm</b> Slanted distal tip Articulation +210°/-210° Direction of view 0°, viewing angle 120°	16.2 Fr	2.5 mm 7.5 Fr	400 mm	•		<b>7315001</b>
					•	<b>7315006</b>
<b>Sensor cystoscope bndl</b> consisting of: Sensor cystoscope 16.2 FR, WL 400 mm (7315001) Leakage tester for flex. endoscopes (163.903), pressure equalization valve (163.904), Luer sealing cap (15023205), and cleaning brush Ø 5 mm, TL 1,200 mm (PACK= 10 PCS) (7990005)				•		<b>73150012</b>
<b>Sensor cystoscope bndl</b> consisting of: Sensor cystoscope 16.2 FR, WL 400 mm (7315006) Leakage tester for flex. endoscopes (163.903), pressure equalization valve (163.904), Luer sealing cap (15023205), and cleaning brush Ø 5 mm, TL 1200 mm (PACK= 10 PCS) (7990005)					•	<b>73150062</b>
<b>Recommended accessories</b>						<b>Product no.</b>
<b>Fiber light cable bndl</b> consisting of: Fiber light cable Ø 2.5 mm TL 2.3 m (80662523), projector-side adapter (8095.07), and endoscope-side adapter (809509)				Ø 2.5 mm, 2.3 m long		<b>806625231</b>

III23 || Subject to modifications. Please note that some products may not be available in all countries. Please always take note of the information that is provided with the product. For more detailed information, please consult with your contact partner or directly with Richard Wolf GmbH.

## TÜBINGER MIC TRAINING DEVICE

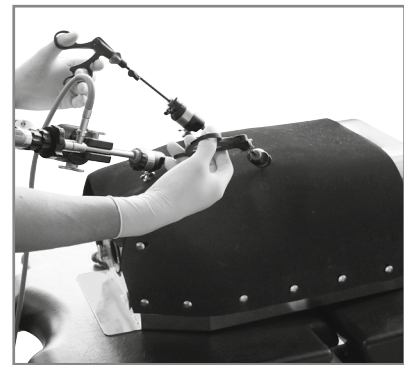
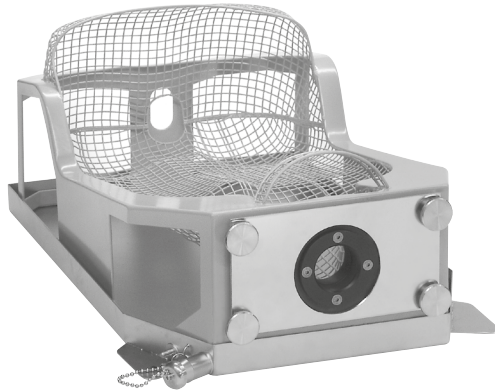

		Product no.
<b>Tübinger MIC trainer</b> with 3 abdominal walls (foam rubber)	(W x H x D) 560 x 350 x 230 mm	<b>9500.056</b>

Recommended accessories		Product no.
<b>Abdominal wall, foam rubber, PACK= 5 PCS</b>		<b>9500.0561</b>
Available on request with transportation case		





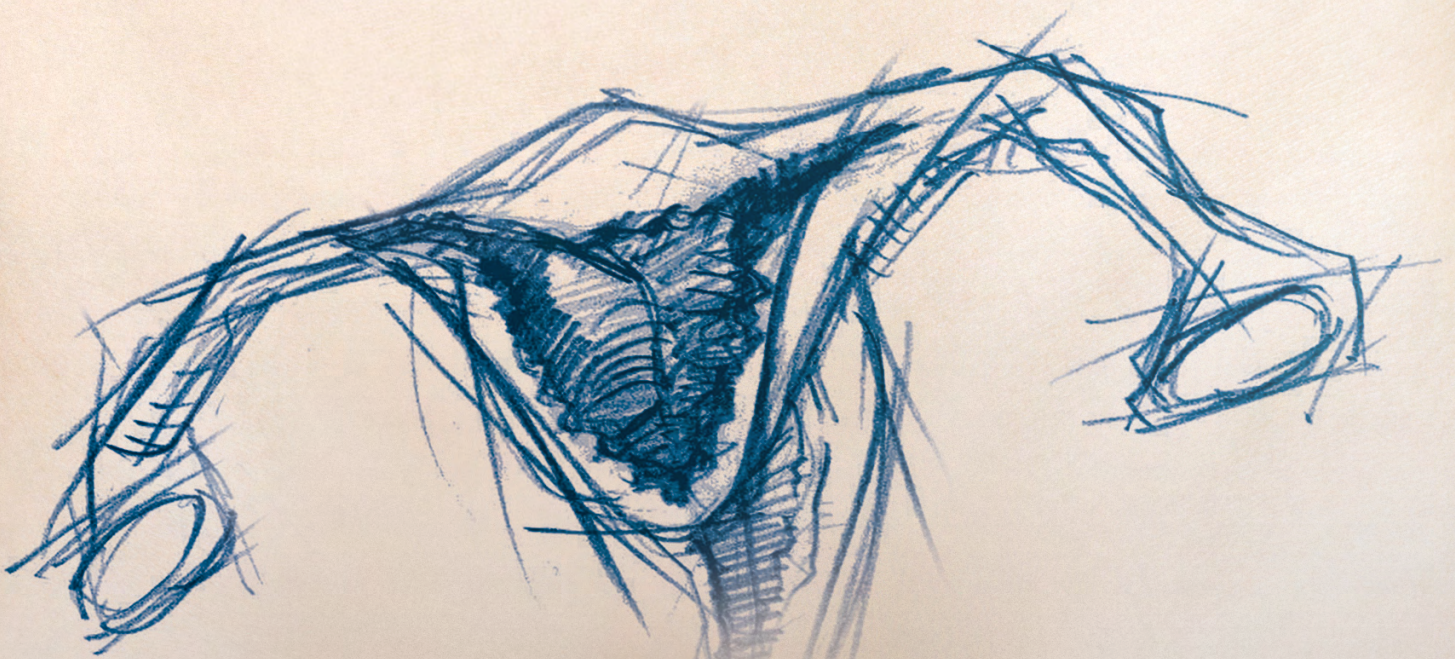

# HYSTERECTOMY

# HYSTERECTOMY

1

---

Secu**FIX** UTERUS MANIPULATOR



---

# SecuFIX UTERUS MANIPULATOR

## SYSTEM WITH COLPOTRANSILLUMINATION AND VACUUM FIXATION



		Product no.
SecuFIX Uterus manipulator Ø 36 mm		8370701
SecuFIX Uterus probe Ø 5 mm	with longitudinal scale	8370702
Cleaning brush Ø 5 mm, TL 515 mm		605
Cleaning brush Ø 9 mm, TL 405 mm		609
Sealing cap capacity 3.4–5.1 mm	(PACK = 10 PCS)	8902
Colpotransilluminator vacuum tube SecuFIX	Set contains: Colpotransilluminator and vacuum tube (with check valve, suction connection, Y connection part for use with a suction instrument on the same suction device, suction clamp), disposable (PACK= 10 PCS, in individual sterile packaging)	41708370

Accessories		Product no.
Irrigation tube L 0.6 m 		163915
Fiber light cable bndl 	Fiber bundle, Ø 3.5 mm (color marking orange), length 2.3 m	806635231
RIWO System Tray 	Container (W x H x D) 500 x 60 x 200 mm with instrument mat Internal dimensions (W x H x D): 500 x 57 x 200 mm, External dimensions (W x H x D): 566 x 77 x 266 mm	33024

1123|| Subject to modifications. Please note that some products may not be available in all countries. Please always take note of the information that is provided with the product. For more detailed information, please consult with your contact partner or directly with Richard Wolf GmbH.



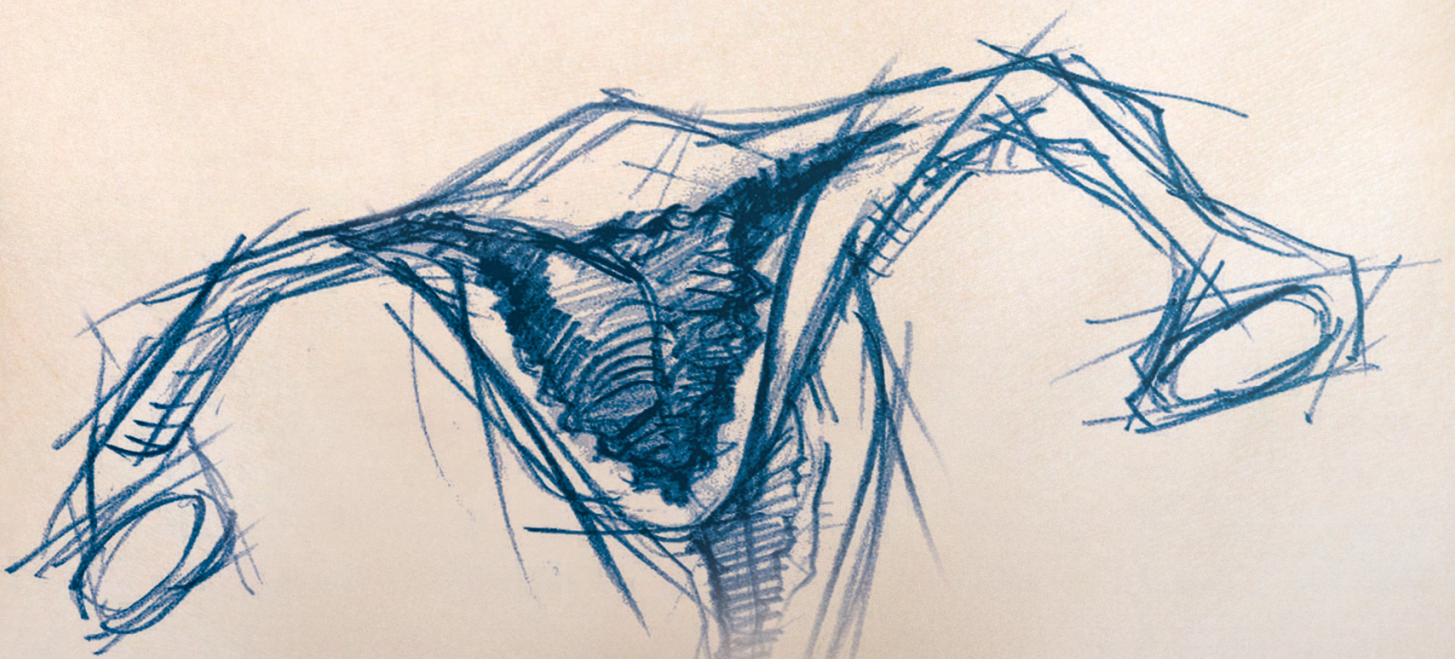

**DIAGNOSTIC AND  
SURGICAL HYSTEROSCOPY**

## DIAGNOSTIC AND SURGICAL HYSTEROSCOPY

1

BASIC SETS

2

TELESCOPES

3

HYSTEROSCOPE SHEATHS FOR 2.5 MM/4.0 MM TELESCOPES

4

HYSTEROSCOPE Ø 3.9 MM, 30°/HYSTEROSCOPE Ø 5 MM, 20°

5

FORCEPS/SCISSORS/SMALL MODULAR SYSTEM **HySafe**

6

ELECTRODES, BIPOLAR, MONOPOLAR

7

INSTRUMENTS FOR PORTIO AND UTERUS

8

HYSTEROSCOPIC RESECTION

9

FLEXIBLE HYSTEROSCOPE

10

DEVICES/ACCESSORIES

## BASIC SET FOR DIAGNOSTIC HYSTEROSCOPY

Product	Product no.	Quantity	Catalog/Section
without working channel			
<b>Telescope 30° Ø 2.7 mm SL 310 mm</b>	<b>8974.402</b>	1	Gynecology / hysteroscopy
<b>Sheath for hysteroscope 10.5 FR</b>	<b>8985.11</b>	1	
<b>Biopsy forceps bndl</b>	<b>8642.6312</b>	1	
<b>Grasping forceps bndl</b>	<b>8642.6502</b>	1	
alternative:			
<b>Hysteroscope bndl</b>	<b>89864021</b>	1	Gynecology / hysteroscopy

**BASIC SET HYSTERO-RESECTOSCOPE**
**PRINCESS™ E-LINE & S(A)LINE SYSTEM,**
**TELESCOPE 2.7 MM, 12°, 21 FR, PASSIVE, CONTINUOUS IRRIGATION**

Product	Product no.	Quantity	Catalog/Section
Outer sheath for resectoscope 21 FR	8653.021	1	Gynecology / hysteroscopy
Inner sheath for resectoscope 19 FR	8653.018	1	
Obturator for resectoscope 19 FR	8653.18	1	
Passive, mono/bipo working element with open handle, passive cutting	8653.224	1	
Telescope 12° Ø 2.7 mm SL 310 mm	8974.412	1	
Cutting electrode bipo 21 FR	46531313	1	
Roller electrode bipo 21/24.5 FR	4653.023	1	
Hook electrode mono/bipo 21/24.5 FR	865303	1	
Protective sterilization sleeve for connection to max. 5 electrodes, reusable	8428.901	1	
Bipolar HF cable	8108....	1	
FLUID CONTROL 2225 Irrigation pump for HYS/URO/LAP bndl	22250011	1	
Balancing module	2225023	1	



# MINI FIBER TELESCOPE 2.0 MM

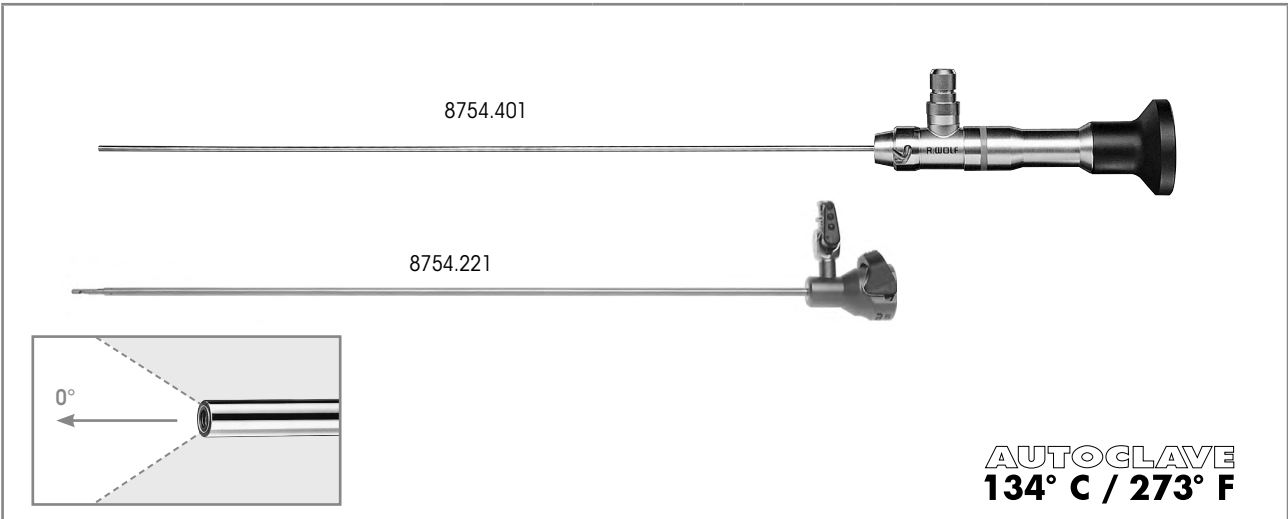

	Direction of view	WL	TL	Ø	Product no.
<b>Telescope 0° Ø 2 mm NL 268 mm</b>	0°	268 mm	365 mm	2.0 mm	<b>8754401</b>
<b>also:</b>					
<b>VERES cannula Ø 2.3 mm WL 250 mm</b> consisting of: 1x VERES cannula Ø 2.3 mm WL 274 mm (8754.211) 1x outer sheath Ø 2.8 mm, WL 250 mm (8754.221)		250 mm		2.3 mm	<b>8754201</b>

Recommended accessories		Product no.
<b>Perforated basket for standard telescope 2</b> (for telescope 8754.401)	(L x W x H) 481 x 59 x 54 mm	<b>38016</b>
<b>Fiber light cable bndl</b> consisting of: Fiber light cable (80662523), projector-side adapter (8095.07), and endoscope-side adapter (809509)	Ø 2.5 mm, 2.3 m long	<b>806625231</b>

1123 Subject to modifications. Please note that some products may not be available in all countries. Please always take note of the information that is provided with the product. For more detailed information, please consult with your contact partner or directly with Richard Wolf GmbH.

## MINI SURGICAL HYSTEROSCOPE



	Direction of view	W x H	WL	TL	Product no.
Telescope 12° W 3.6 mm H 2 mm WL 227 mm with lateral eyepiece	12°	3.6 x 2.0 mm	227 mm	358 mm	<b>8753.411</b>

**also:**

	Color coding	WL	Outer Ø	Working channel	Product no.
Outer sheath for hysteroscope 15 FR	yellow	214 mm	3.8 mm	3 Fr	<b>8753.001</b>
Inner sheath for hysteroscope		-	1.5 mm		<b>8753.002</b>
Outer sheath for hysteroscope 15 FR	blue	214 mm	4.8 mm	5 Fr	<b>8753.003</b>
Inner sheath for hysteroscope		-	2.2 mm x 3.42 mm		<b>8753.004</b>
Outer sheath for hysteroscope 15.5 FR	green	214 mm	5.4 mm	7 Fr	<b>8753.006</b>
Inner sheath for hysteroscope		-	2.8 mm x 2.98 mm		<b>8753.007</b>
Outer sheath for hysteroscope 17.5 FR	white	214 mm	5.8 mm	9 Fr	<b>8753.008</b>
Inner sheath for hysteroscope		-	3.5 mm x 4.04 mm		<b>8753.009</b>

**Recommended accessories**

	Product no.
Rigid grasping forceps Ø 3 mm WL 346 mm 	<b>8993.235</b>
Perforated basket for hysteroscope 1 for holding replacement sheaths, with small parts basket	Internal dimens. (W x H x D): 51 x 65 x 124 mm External dimens. (W x H x D): 467 x 75 x 132 mm <b>38006</b>
Fiber light cable bndl consisting of: Fiber light cable (80662523), projector-side adapter (8095.07), and endoscope-side adapter (809509)	Ø 2.5 mm, 2.3 m long <b>806625231</b>

# HYSTEROSCOPE TELESCOPES

## Ø 2.7 MM/Ø 4.0 MM

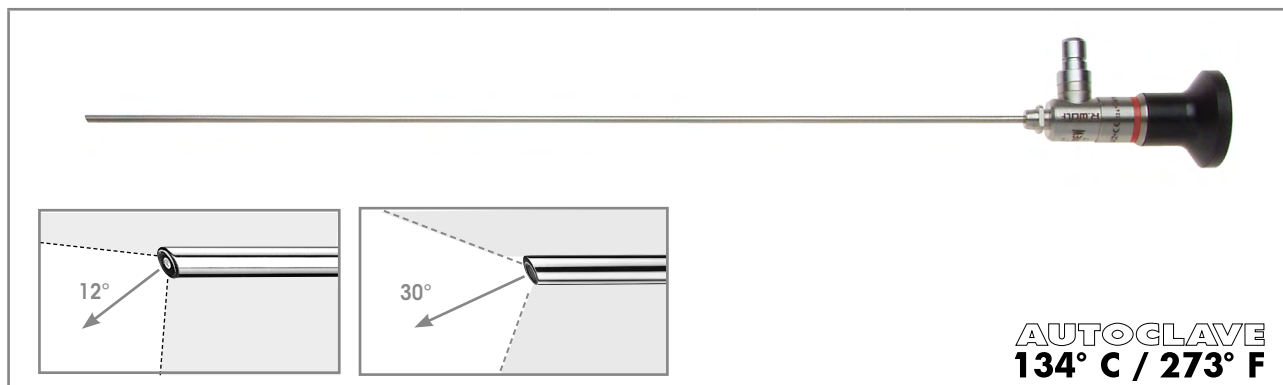

	Direction of view	Ø	SL	TL	Product no.
Telescope 12° Ø 2.7 mm SL 310 mm	12°	2.7 mm	310 mm	373 mm	8974.412
Telescope 30° Ø 2.7 mm SL 310 mm	30°	2.7 mm	310 mm	370 mm	8974.402

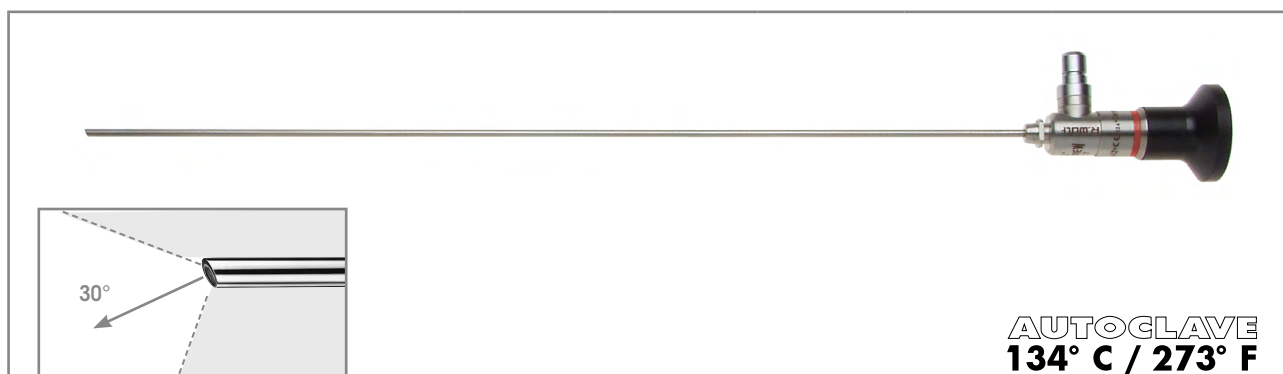

	Direction of view	Ø	SL	TL	Product no.
Telescope 30° Ø 4 mm SL 299 mm	30°	4.0 mm	299 mm	372 mm	8989.412



Recommended accessories		Product no.
Perforated basket for standard telescope 2	Dimensions (L x W x H): 481 x 59 x 54 mm	38016
Fiber light cable bndl consisting of: Fiber light cable (80662523), projector-side adapter (8095.07), and endoscope-side adapter (809509)	Ø 2.5 mm, 2.3 m long	806625231

1123 || Subject to modifications. Please note that some products may not be available in all countries. Please always take note of the information that is provided with the product. For more detailed information, please consult with your contact partner or directly with Richard Wolf GmbH.

# DIAGNOSTIC HYSTEROSCOPE SHEATH

10.5 FR /Ø 3.5 MM

FOR TELESCOPE 2.7 MM, 30°



						
		Sheath	WL		Product no.	
		10.5 Fr/ Ø 3.5 mm	255 mm		<b>8985.11</b>	
<b>Sheath for hysteroscope 10.5 FR round</b>						
					<b>8986.251</b>	
<b>Handle for hysteroscope</b>						
<b>also:</b>						
		Direction of view	Ø	SL	TL	Product no.
<b>Telescope 30° Ø 2.7 mm SL 310 mm</b>		30°	2.7 mm	310 mm	370 mm	<b>8974.402</b>

Recommended accessories		Product no.
<b>Perforated basket for standard telescope 2</b>	Dimensions (L x W x H): 481 x 59 x 54 mm	<b>38016</b>
<b>Fiber light cable bndl</b> consisting of: Fiber light cable (80662523), projector-side adapter (8095.07), and endoscope-side adapter (809509)	Ø 2.5 mm, 2.3 m long	<b>806625231</b>

1123 | Subject to modifications. Please note that some products may not be available in all countries. Please always take note of the information that is provided with the product. For more detailed information, please consult with your contact partner or directly with Richard Wolf GmbH.

# DIAGNOSTIC HYSTEROSCOPE SHEATH 12 FR, OVAL

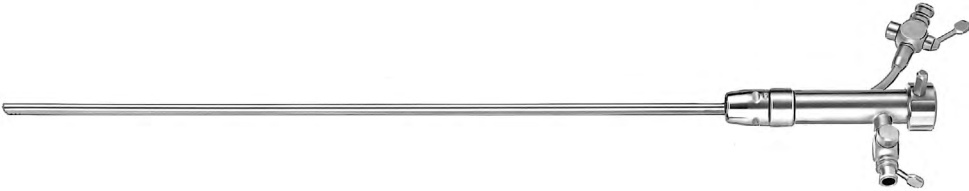
FOR TELESCOPE 2.7 MM, 30°

					
	Sheath	Working channel	WL	Product no.	
	12 Fr	3 Fr	246 mm	<b>8974.121</b>	
<b>Sheath for hysteroscope 12 FR oval</b>					
				<b>8986.251</b>	
<b>Handle for hysteroscope</b>					
<b>also:</b>					
	Direction of view	Ø	SL	TL	Product no.
<b>Telescope 30° Ø 2.7 mm SL 310 mm</b>	30°	2.7 mm	310 mm	370 mm	<b>8974.402</b>

Recommended accessories		Product no.
<b>Perforated basket for standard telescope 2</b>	Dimensions (L x W x H): 481 x 59 x 54 mm	<b>38016</b>
<b>Fiber light cable bndl</b> consisting of: Fiber light cable (80662523), projector-side adapter (8095.07), and endoscope-side adapter (809509)	Ø 2.5 mm, 2.3 m long	<b>806625231</b>

**OptiFLOW™**



**HIGHFLOW CONTINUOUS IRRIGATION SURGICAL SHEATH**

**5.5 MM**

FOR TELESCOPE 2.7 MM, 12° AND 30°

SHEATHS

3

					
	Sheath	Working channel	WL	Product no.	
	12 Fr	5 Fr	219 mm	<b>8974351</b>	
<b>Sheath for hysteroscope 16.5 FR</b> distal sheath end, oval					
				<b>8986.251</b>	
<b>Handle for hysteroscope</b>					
<b>also:</b>					
	Direction of view	Ø	SL	TL	Product no.
<b>Telescope 12° Ø 2.7 mm SL 310 mm</b>	12°	2.7 mm	310 mm	373 mm	<b>8974.412</b>
<b>Telescope 30° Ø 2.7 mm SL 310 mm</b>	30°	2.7 mm	310 mm	370 mm	<b>8974.402</b>



Recommended accessories	Product no.
<b>Perforated basket for standard telescope 2</b>	Dimensions (L x W x H): 481 x 59 x 54 mm <b>38016</b>
<b>Fiber light cable bndl</b> consisting of: Fiber light cable (80662523), projector-side adapter (8095.07), and endoscope-side adapter (809509)	Ø 2.5 mm, 2.3 m long <b>806625231</b>

1123 | Subject to modifications. Please note that some products may not be available in all countries. Please always take note of the information that is provided with the product. For more detailed information, please consult with your contact partner or directly with Richard Wolf GmbH.

# DIAGNOSTIC HYSTEROSCOPE SHEATH

## 15 FR

FOR TELESCOPE 4 MM, 30°

					
	Sheath	Working channel	WL	Product no.	
	12 Fr	3 Fr	255 mm	<b>8989.151</b>	
<b>Sheath for hysteroscope 15 FR</b> distal sheath end, oval					
				<b>8986.251</b>	
<b>Handle for hysteroscope</b>					
<b>also:</b>					
	Direction of view	Ø	SL	TL	Product no.
<b>Telescope 30° Ø 4 mm SL 299 mm</b>	30°	4.0 mm	299 mm	372 mm	<b>8989.412</b>



Recommended accessories	Product no.
<b>Perforated basket for standard telescope 2</b>	Dimensions (L x W x H): 481 x 59 x 54 mm <b>38016</b>
<b>Fiber light cable bndl</b> consisting of: Fiber light cable (80662523), projector-side adapter (8095.07), and endoscope-side adapter (809509)	Ø 2.5 mm, 2.3 m long <b>806625231</b>

1123|| Subject to modifications. Please note that some products may not be available in all countries. Please always take note of the information that is provided with the product. For more detailed information, please consult with your contact partner or directly with Richard Wolf GmbH.

# SURGICAL CONTINUOUS IRRIGATION HYSTEROSCOPE SHEATH

## 15 FR OVAL

FOR TELESCOPE 4 MM, 30°

					
	Sheath	Working channel	WL	Product no.	
	15 Fr	3 Fr	230 mm	<b>8989.031</b>	
<b>Sheath for hysteroscope 15 FR</b> distal sheath end, oval					
				<b>8986.251</b>	
<b>Handle for hysteroscope</b>					
<b>also:</b>					
	Direction of view	Ø	SL	TL	Product no.
<b>Telescope 30° Ø 4 mm SL 299 mm</b>	30°	4.0 mm	299 mm	372 mm	<b>8989.412</b>







Recommended accessories	Product no.
<b>Perforated basket for standard telescope 2</b>	Dimensions (L x W x H): 481 x 59 x 54 mm <b>38016</b>
<b>Fiber light cable bndl</b> consisting of: Fiber light cable (80662523), projector-side adapter (8095.07), and endoscope-side adapter (809509)	Ø 2.5 mm, 2.3 m long <b>806625231</b>



# SURGICAL CONTINUOUS IRRIGATION HYSTEROSCOPE SHEATH

## 21 FR

### FOR TELESCOPE 4 MM, 30°

byGallinat					
8988.031 					
8988.231 					
8988.241 					
		Sheath	Working channel	WL	Product no.
	with oblique distal end, rotatable drain stopcock, and quick release lock	21 Fr	-	204 mm	<b>8988.031</b>
also:					
	specifically for 8988.031				<b>8988.131</b>
	with deflection lever and supply stopcock		7 Fr		<b>8988.231</b>
	with ramp and supply stopcock		7 Fr		<b>8988.241</b>
also:					
	Direction of view	Ø	SL	TL	Product no.
Telescope 30° Ø 4 mm SL 299 mm	30°	4.0 mm	299 mm	372 mm	<b>8989.412</b>
Recommended accessories					Product no.
Perforated basket for standard telescope 2		Dimensions (L x W x H): 481 x 59 x 54 mm			<b>38016</b>
Fiber light cable bndl consisting of: Fiber light cable (80662523), projector-side adapter (8095.07), and endoscope-side adapter (809509)		Ø 2.5 mm, 2.3 m long			<b>806625231</b>



1123 Subject to modifications. Please note that some products may not be available in all countries. Please always take note of the information that is provided with the product. For more detailed information, please consult with your contact partner or directly with Richard Wolf GmbH.

# HYSTEROSCOPE

## 3.9 MM, 30°

HYSTEROSCOPE

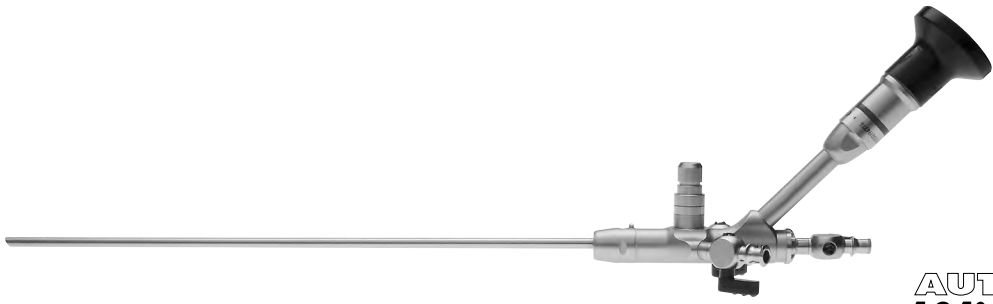
4

 <p><b>AUTOCLAVE</b> <b>134° C / 273° F</b></p>				
	Sheath	Working channel	WL	Product no.
 <p><b>Hysteroscope bndl</b> consisting of: Hysteroscope 30° Ø 3.9 mm WL 217 mm (8986402) and rubber cap capacity 0.8 mm (PACK = 10 PCS, 88.01)</p>	Ø 3.9 mm	5 Fr	217 mm	<b>89864021</b>
<p><b>Handle for hysteroscope</b></p>				<b>8986.251</b>



Recommended accessories		Product no.
<p><b>Perforated basket for hysteroscope 2</b> with small part basket</p>	<p>Internal dimensions (W x H x D): 451 x 80 x 124 mm, External dimensions (W x H x D): 467 x 90 x 132 mm</p>	<b>38009</b>
<p><b>Fiber light cable bndl</b> consisting of: Fiber light cable (80662523), projector-side adapter (8095.07), and endoscope-side adapter (809509)</p>	Ø 2.5 mm, 2.3 m long	<b>806625231</b>

1123 | Subject to modifications. Please note that some products may not be available in all countries. Please always take note of the information that is provided with the product. For more detailed information, please consult with your contact partner or directly with Richard Wolf GmbH.

# HYSTEROSCOPE

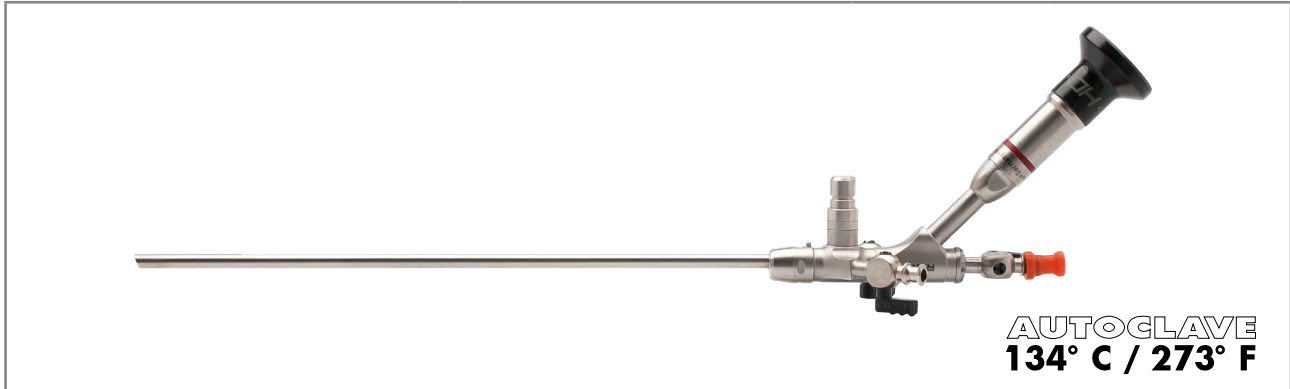
## 5 MM, 20°





	Sheath	Working channel	WL	Product no.
 <b>Hysteroscope 20° Ø 5 mm WL 217 mm</b> with lateral eyepiece	Ø 5 mm	5 Fr	217 mm	<b>8986.401</b>
<b>Handle for hysteroscope</b>				<b>8986.251</b>

Recommended accessories		Product no.
<b>Perforated basket for hysteroscope 2</b> with small part basket	Internal dimensions (W x H x D): 451 x 80 x 124 mm, External dimensions (W x H x D): 467 x 90 x 132 mm	<b>38009</b>
<b>Fiber light cable bndl</b> consisting of: Fiber light cable (80662523), projector-side adapter (8095.07), and endoscope-side adapter (809509)	Ø 2.5 mm, 2.3 m long	<b>806625231</b>

1123 || Subject to modifications. Please note that some products may not be available in all countries. Please always take note of the information that is provided with the product. For more detailed information, please consult with your contact partner or directly with Richard Wolf GmbH.







## RIGID PREPARATION FORCEPS 7 FR

				
with irrigation connector	Fr	WL	TL	Product no.
 <p><b>Rigid preparation forceps 7 FR WL 371 mm</b> with internal and external toothings</p>	7 Fr	371 mm	460 mm	<b>8992.621</b>

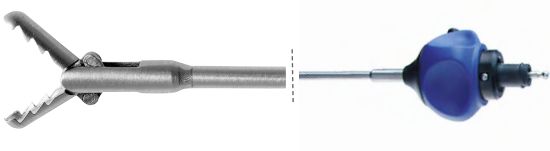
# FORCEPS AND SCISSORS

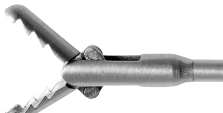
## SMALL MODULAR SYSTEM **HySafe**



360° ROTATABLE, CAN BE FLUSHED THROUGH, EASY CLICK

Grasping forceps jaw insert with sheath				Handle with overload protection	Complete instrument
					<ul style="list-style-type: none"> <li>Jaw section</li> <li>Handle</li> </ul>
	Product no.	Fr	WL	8083.001	Product no.
	8642.6508	5	340 mm	•	<b>8642.6502</b>
	8992.6308	7	310 mm	•	<b>8992.6302</b>
	8642.6008	5	340 mm	•	<b>8642.6002</b>
	8642.6818	5	340 mm	•	<b>8642.6812</b>
	8642.6318	5	340 mm	•	<b>8642.6312</b>
	8992.6408	7	310 mm	•	<b>8992.6402</b>

## MONOPOLAR ELECTRODE 5/6 FR

MONOPOLAR



	Fr	WL	Product no.
 <b>Coagulation electrode mono 6 FR WL 400 mm</b>	6 Fr	400 mm	<b>823.06</b>
 <b>Needle electrode mono 5 FR WL 420 mm</b>	5 Fr	420 mm	<b>824.05</b>

HF connection cable: see page GYN44/45

1123 | Subject to modifications. Please note that some products may not be available in all countries. Please always take note of the information that is provided with the product. For more detailed information, please consult with your contact partner or directly with Richard Wolf GmbH.

## FOR PORTIO AND UTERUS

	WL	TL	Product no.
			
 <b>Uterus grasping forceps WL 92 mm,</b> by Pozzi with distally overlapping tips	92 mm	254 mm	<b>8370.25</b>
 <b>Uterus grasping forceps WL 100 mm,</b> by Gimpelson with four spherical teeth	100 mm	242 mm	<b>8371.10</b>
 <b>Uterus grasping forceps Ø 6.5 mm WL 100 mm,</b> by Saarges	100 mm	262 mm	<b>8370.00</b>

for fixation, elevation, as well as hydro and chromopertubation of the uterus

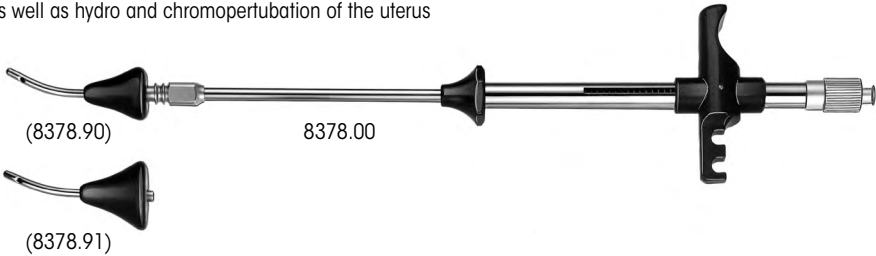
  
(8378.90) 8378.00  
(8378.91)









	WL	TL	Product no.
<b>Intrauterine probes bndl</b> consisting of: Intrauterine probe Ø 32 mm WL 32 mm, by Cohen (8378.00), conical portio adapter size small (8378.90), conical portio adapter size large (8378.91), tube with Luer-Lock connector (886.00)	32 mm	330 mm	<b>8378001*</b>

\*also: Uterus grasping forceps WL 92 mm, by Pozzi (8370.25)

**PRINCESS**  
**PETIT RESECTOSCOPE INCLUDING**  
**E-LINE & S(A)LINE SYSTEM**



**AUTOGLAVE**  
**134° C / 273° F**

Size, Color coding	distal end	Outersheath for resectoscope 21 FR	Inner sheath for resectoscope 19 FR	Passive, mono/bipo working element with open handle		Telescope 12° Ø 2.7 mm SL 310 mm	Obturator	
				passive cutting	active cutting		Viewing obturator for resectoscope 19 FR	Obturator for resectoscope 19 FR
								
<b>7 mm</b> 21 Fr black		<b>8653.021</b>	<b>8653.018</b>	<b>8653.224</b>	<b>8653204</b>	<b>8974.412</b>	<b>865319</b>	<b>8653.18</b>
also:								
<b>Electrodes:</b> see page GYN26								









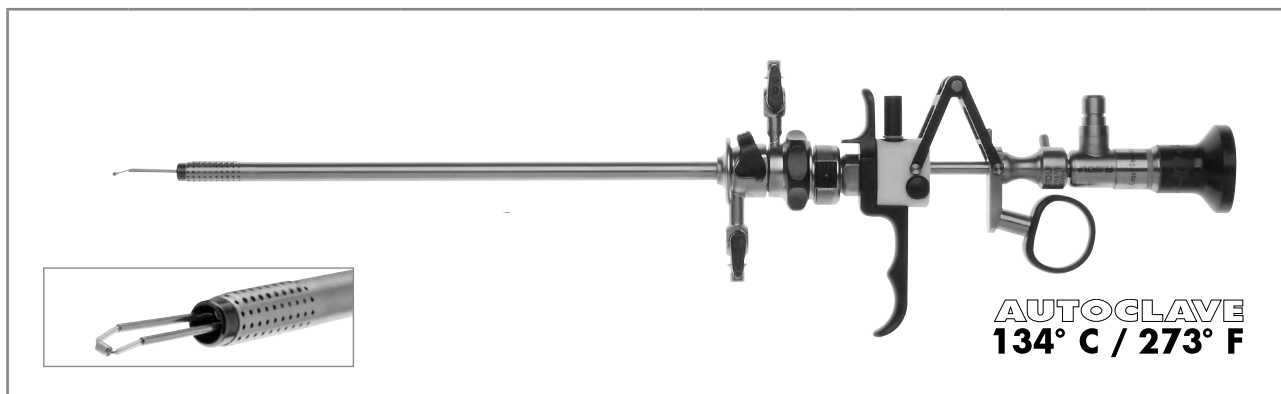

Recommended accessories		Product no.
<b>Working insert for resectoscope</b> for auxiliary instruments up to 7 Fr		<b>8653284</b>
<b>HF bipolar connection cable L 3 m</b>	for KLS-Martin generators, M-version	<b>8108.231</b>
	for Erbe generators	<b>8108.232</b>
<b>Container (W x H x D) 400 X 60 X 200 mm</b>	Internal dimensions (W x H x D): 400 x 57 x 200 mm External dimensions (W x H x D): 466 x 77 x 266 mm	<b>33022</b>
<b>Fiber light cable bndl</b> consisting of: Fiber light cable (80662523), projector-side adapter (809.507), and endoscope-side adapter (809509)	Ø 2.5 mm, 2.3 m long	<b>806625231</b>

1123 || Subject to modifications. Please note that some products may not be available in all countries. Please always take note of the information that is provided with the product. For more detailed information, please consult with your contact partner or directly with Richard Wolf GmbH.



**PRINCESS**  
**PETIT RESECTOSCOPE INCLUDING**  
**E-LINE & S(A)LINE SYSTEM, ROTATABLE**



Size, Color coding	distal end	Outersheath for resectoscope 21 Fr	Inner sheath for resectoscope 19 Fr	Working element with open handle		Telescope 12° Ø 2.7 mm SL 310 mm	Obturators	
				passive cutting	active cutting		Viewing obturator for resectoscope 19 Fr	Obturator for resectoscope 19 Fr
Sheaths								
<b>7 mm</b> 21 Fr black		<b>8653022</b>	<b>8653019</b>	<b>8653.224</b>	<b>8653204</b>	<b>8974.412</b>	<b>865319</b>	<b>8653.18</b>
<b>8 mm</b> 24.5 Fr green		<b>8655.334</b>	<b>8655.344</b>					
also:								
<b>Electrodes:</b> see page GYN 26 								





Recommended accessories	Product no.	
<b>Working insert for resectoscope</b> for auxiliary instruments up to 7 Fr 	<b>8653284</b>	
<b>HF bipolar connection cable L 3 m</b>	for KLS-Martin generators, M-version	<b>8108.231</b>
	for Erbe generators	<b>8108.232</b>
<b>Container (W x H x D) 400 X 60 X 200 mm</b>	Internal dimensions (W x H x D): 400 x 57 x 200 mm External dimensions (W x H x D): 466 x 77 x 266 mm	<b>33022</b>
<b>Fiber light cable bndl</b> consisting of: Fiber light cable (80662523), projector-side adapter (809.507), and endoscope-side adapter (809509)	Ø 2.5 mm, 2.3 m long	<b>806625231</b>

1123 Subject to modifications. Please note that some products may not be available in all countries. Please always take note of the information that is provided with the product. For more detailed information, please consult with your contact partner or directly with Richard Wolf GmbH.

# ELECTRODES

FOR PRINCESS RESECTOSCOPE,  
TELESCOPE 2.7 MM, 12°

## 12°, for multiple use, monopolar/bipolar

	Designation	Bracket	for sheath sizes [in Fr]		Color coding		Product no.
			CI 21	CI 24.5	Fork	Stem	
	Cutting electrode mono 21 FR	Loop round Ø 0.3 mm	•	–	red	blue	8653.131
	Cutting electrode mono 24.5 FR	Loop round Ø 0.3 mm	–	•	blue	blue	8653.132
	Roller electrode mono 21/24.5 FR	Roll	•	•	red	blue	8653.02
	Hook electrode mono/bipo 21/24.5 FR	Hook	•	•	red	blue	865303

• suitable for corresponding sheath size – not suitable CI = continuous irrigation

## 12°, disposable, sterile\* bipolar

(PACK = 3 PCS)	Designation	Bracket	for sheath sizes [in Fr]		Color coding		Product no.
			CI 21	CI 24.5	Fork	Stem	
	Cutting electrode bipo 21 FR	Loop round Ø 0.3 mm	•	–	transparent	blue	46531313
	Cutting electrode bipo 24.5 FR	Loop round Ø 0.3 mm	–	•	transparent	blue	4653.1323
	Roller electrode bipo 21/24.5 FR	Roll	•	•	transparent	blue	4653.023
	BIVAP electrode bipo 21 FR	Torus	•	–	blue	blue	46530213
	BIVAP electrode bipo 24.5 FR	Torus	–	•	blue	blue	46530243
	Hook electrode 21/24.5 FR	Hook	•	•	blue	blue	4653033

• suitable for corresponding sheath size – not suitable \* in individual sterile packaging CI = continuous irrigation

### Recommended accessories





	Product no.
<b>Protective sterilization sleeve</b> for connection to max. 5 electrodes, reusable 	<b>8428.901</b>

1123 | Subject to modifications. Please note that some products may not be available in all countries. Please always take note of the information that is provided with the product. For more detailed information, please consult with your contact partner or directly with Richard Wolf GmbH.

# RESECTION MASTER WITH AUTOMATIC CHIP SUCTION



**AUTOGLAVE**  
**134° C / 273° F**



Size, Color coding	distal end	Outersheath for resectoscope 27 FR	Working element passive mono/bipo	Telescope 30° Ø 3.3 mm SL 299 mm	Obturator for resectoscope
			passive cutting		
Sheath					
<b>9 mm</b> 27 Fr black		<b>8659.071</b>	<b>8659.2351</b>	<b>8656.422</b>	<b>8659.175</b>

Recommended accessories		Product no.
<b>Tube set RESECTION PUMP 2228</b> disposable	PVC, (PACK = 10 PCS) in individual sterile packaging	<b>4170.2228</b>
<b>Container (W x H x D) 400 X 60 X 200 mm</b>	Internal dimensions (W x H x D): 400 x 57 x 200 mm External dimensions (W x H x D): 466 x 77 x 266 mm	<b>33022</b>
<b>Fiber light cable bndl</b> consisting of: Fiber light cable (80662523), projector-side adapter (809.507), and endoscope-side adapter (809509)	Ø 2.5 mm, 2.3 m long	<b>806625231</b>

# ELECTRODES



## FOR RESECTION MASTER WITH AUTOMATIC CHIP SUCTION

### 30°, for multiple use, monopolar/bipolar

	Designation	Bracket	for sheath sizes [in Fr]		Color coding		Product no.
			CI	27	Fork	Stem	
	Cutting electrode mono 27 FR	Loop round Ø 0.25 mm	•		red	red	8659.161
	Vapo electrode mono 27 FR	Loop cylindrical	•		blue	blue	8659.162
	Hook electrode mono/bipo 27 FR	Hook	•		red	red	8659.163

**CI** = continuous irrigation

### 30°, disposable, sterile\*, bipolar

(PACK = 3 PCS)	Designation	Bracket	for sheath sizes [in Fr]		Color coding		Product no.
			CI	27	Fork	Stem	
	Cutting electrode bipo 27 FR	Loop round Ø 0.25 mm	•		blue	blue	4659.1613
	Roller electrode bipo 27 FR	Loop Roll Ø 0.3 mm	•		blue	blue	4659.1623

\* in individual sterile packaging **CI** = continuous irrigation

#### Recommended accessories

	Product no.
<b>Protective sterilization sleeve</b> for connection to max. 5 electrodes, reusable 	<b>8428.901</b>

1123 | Subject to modifications. Please note that some products may not be available in all countries. Please always take note of the information that is provided with the product. For more detailed information, please consult with your contact partner or directly with Richard Wolf GmbH.

## RESECTION PUMP 2228

MICROPROCESSOR-CONTROLLED HIGH-PERFORMANCE CHIP SUCTION PUMP  
WITH CLEAR LCD DISPLAY



		Product no.
RESECTION PUMP 2228 Suction pump		2228.001
<b>also:</b>		
<b>Tube set RESECTION PUMP 2228</b> (PACK = 10 PCS.) packed singly, sterile	consisting of: Control tube with filter, irrigation tube with non-return valve, chip aspiration tube with non-return valve and pump tube	4170.2228
<b>Bottle holder cpl.</b>		64030.125
<b>Bottle mount</b>		64031.381
<b>Overflow protection / bacteria filter</b> for single use (PACK = 10 PCS)		2228.901
<b>Chip collecting container</b> 250 ml for tissue chips		2228.801
<b>Tube insert</b> for collecting container 250 ml		2228.802
<b>Secretion container 2L</b> autoclavable		8170.6551
<b>Cover</b> for secretion container 2L		8170.6552
<b>Sound absorber</b> (PACK = 3 PCS)		35100.115
<b>Connection tube recto pump</b>		8170.6554
<b>Power cable</b>	cable length 3 m	2440.03

# TECHNICAL DATA

## RESECTION PUMP 2228







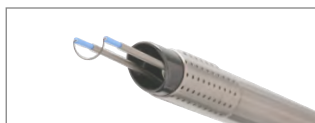

RESECTION PUMP 2228		2228.001
<b>Device properties</b>		
Operating conditions	+10°C to +40°C, 30% to 75% rel. humidity, atmospheric pressure 800 hPa to 1,060 hPa	
Storage and transport conditions	- 20°C to +60°C , 10% to 90% rel. humidity, atmospheric pressure 700 hPa to 1,060 hPa	
<b>Power supply</b>		
Mains + frequency	100–240 V~, 50/60 Hz	
Power consumption	120 VA	
Current rating	1.2–0.5	
Fuse	T 1.6 AL 250 V	
<b>Regulatory standards</b>		
Protection class to EN/IEC 60601-1 (UL 2601-1/CSA C22.2 No.601.1 – for USA)	I	
Electromagnetic compatibility (EMC)	EN/IEC 60601-1-2	
Medical Devices Directive 93/42/EEC	Class II a	
Degree of protection against the ingress of liquids	IP 20 (not protected)	
Noise level	55 dB (A) (pump "ON" with container)	
Operating mode	Continuous operation	
Protection against electric shock	Type BF applied part	
Degree of protection in the presence of flammable mixtures	Device is not protected against explosions (do not operate this device in explosive atmospheres)	
<b>Dimensions and weights</b>		
Weight, bndl with accessories	8.9 kg (19.6 lbs)	
Dimensions (W x H x D)	340 mm x 105 mm x 420 mm	
Space requirements with bottle holder (W x H x D)	470 mm x 410 mm x 430 mm	
<b>Relevant application parameters</b>		
Vacuum Operation vacuum Maximum vacuum	650 to 750 mbar +/- 50 mbar 750 mbar +/- 50 mbar	
Suction pulse Level 1 (low) Level 2 (medium) Level 3 (high)	3.8 ml +/- 0.5 ml 6.2 ml +/- 0.7 ml 9.2 ml +/- 1.0 ml	

**Shark** BIPOLAR RESECTOSCOPE  
 FOR TELESCOPE 4 MM, 30°, 12  
 WITH CONTINUOUS IRRIGATION DOUBLE SHEATH SYSTEM FOR RESECTION IN SALINE SOLUTION

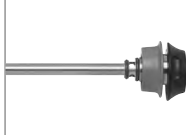
Working element, inner sheath, and telescope rotate in outer sheath



**AUTOCLAVE**  
**134° C / 273° F**

Size, Color coding	distal end	Outersheath for resectoscope 24 FR	Inner sheath for resectoscope 22 FR	Telescope 30° Ø 4 mm NL 300 mm	Telescope 12° Ø 4 mm WL 297 mm	Obturator	
						Obturator for resectoscope 22 FR	Viewing obturator for resecto- scope 22 FR
Sheaths							
22/24 Fr green		<b>8675424</b>	<b>8675322</b>	<b>8654.422</b>	<b>8654.431</b>	<b>8673022</b>	<b>8673122</b>

also:

**Working elements:** see page GYN32

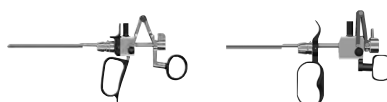





**Electrodes:** see page GYN33

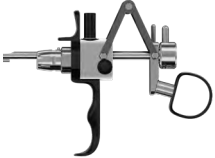

Recommended accessories	Product no.
<b>HF bipolar connection cable</b>	See page GYN54/55
<b>Perforated basket for standard telescope 2</b>	Internal dimensions (W x H x D): 454 x 52 x 40 mm External dimensions (W x H x D): 481 x 54 x 59 mm <b>38016</b>
<b>Fiber light cable bndl</b> consisting of: Fiber light cable (80662523), projector-side adapter (8095.07), and endoscope-side adapter (809509)	Ø 2.5 mm, 2.3 m long <b>806625231</b>

## WORKING ELEMENTS

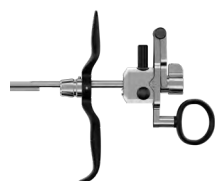
FOR  BIPOLAR RESECTOSCOPES  
TELESCOPE 4 MM, 30°, 12°

		Handle variants	cutting	Product no.
<p><b>Active working element</b> bipo 0/12/30°</p> <p>Cut is made against spring pressure</p>		open	active	<b>8680.204</b>
<p><b>Active working element</b> bipo 0/12/30°</p> <p>Cut is made against spring pressure</p>		closed		<b>8680.205</b>
<p><b>Passive working element</b> bipo 0/12/30°</p> <p>Cut is made with spring pressure</p>		open	passive	<b>8680.224</b>
<p><b>Passive working element</b> bipo 0/12/30°</p> <p>Cut is made with spring pressure</p>		closed		<b>8680.225</b>



Recommended accessories		Product no.
<p><b>Rubber cap, black</b> (PACK = 5 PCS)</p>	for sealing off the electrode clamping mechanism on the working element	<b>8880</b>
<p><b>Thumb ring</b> with relatively large inner diameter</p>		<b>15008.159</b>

1123 | Subject to modifications. Please note that some products may not be available in all countries. Please always take note of the information that is provided with the product. For more detailed information, please consult with your contact partner or directly with Richard Wolf GmbH.



# ELECTRODES

FOR  BIPOLAR RESECTOSCOPES  
TELESCOPE 4 MM, 30°, 12°

12°/30°, for multiple use, bipolar							
	Designation	Bracket	for sheath sizes [in Fr]		Color coding		Model
			CI	22/24	Fork	Stem	
	Cutting electrode bipo 22 FR 12/30°	Loop round Ø 0.3 mm	•		blue	yellow	8622133
	Coag. electrode bipo 22-26 FR 12/30°	Cylinder Ø 1.2 mm	•		blue	yellow	8623022
	Hook electrode bipo 22-26 FR 12/30°	Hook	•		blue	yellow	862309

- suitable for corresponding sheath size **CI** = continuous irrigation

12°/30°, disposable, sterile*, bipolar							
(PACK = 3 PCS)	Designation	Bracket	for sheath sizes [in Fr]		Color coding		Model
			CI	22/24	Fork	Stem	
	Cutting electrode mono 22 FR 12/30°	Loop round Ø 0.25 mm	•		blue	blue	4622.2533
	Cutting electrode bipo 22 FR 12/30°	Loop round Ø 0.3 mm	•		blue	blue	4622.1333
	Coag. electrode bipo 22 FR 12/30°	Cylinder Ø 1.2 mm	•		blue	blue	4623.0243
	BIVAP electrode bipo 22 FR 12/30°	Torus	•		blue	blue	46300223

- suitable for corresponding sheath size \* in individual sterile packaging **CI** = continuous irrigation





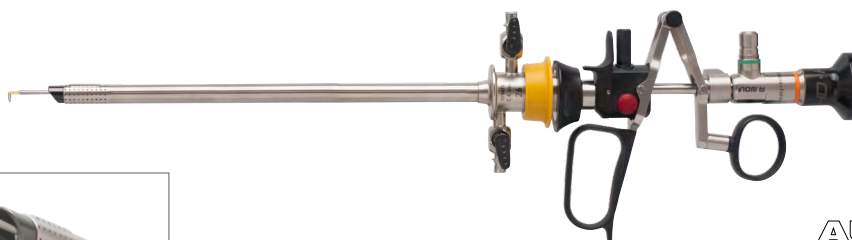
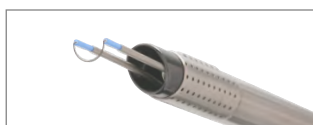

Recommended accessories	Product no.
<b>Protective sterilization sleeve</b> for connection to max. 5 electrodes, reusable 	<b>8428.901</b>

**Shark** MONOPOLAR RESECTOSCOPE  
FOR TELESCOPE 4 MM, 30°, 12°  
WITH CONTINUOUS IRRIGATION DOUBLE SHEATH SYSTEM

Working element, inner sheath, and telescope rotate in outer sheath



**AUTOCLAVE**  
**134° C / 273° F**

Size, Color coding	distal end	Outersheath for resectoscope 24 FR	Inner sheath for resectoscope 22 FR	Telescope 30° Ø 4 mm NL 300 mm	Telescope 12° Ø 4 mm WL 297 mm	Obturator	
						Obturator for resectoscope 22 FR	Viewing obturator for resecto- scope 22 FR
Sheaths							
22/24 Fr green		<b>8675424</b>	<b>8675322</b>	<b>8654.422</b>	<b>8654.431</b>	<b>8673022</b>	<b>8673122</b>

also:

**Working elements:** see page GYN35

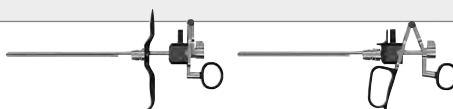

**Electrodes:** see page GYN36/37







Recommended accessories	Product no.
<b>HF monopolar connection cable</b>	<b>See page GYN44/45</b>
<b>Perforated basket for standard telescope 2</b>	Internal dimensions (W x H x D): 454 x 52 x 40 mm External dimensions (W x H x D): 481 x 54 x 59 mm <b>38016</b>
<b>Fiber light cable bndl</b> consisting of: Fiber light cable (80662523), projector-side adapter (809.507), and endoscope-side adapter (809509)	Ø 2.5 mm, 2.3 m long <b>806625231</b>

1123 | Subject to modifications. Please note that some products may not be available in all countries. Please always take note of the information that is provided with the product. For more detailed information, please consult with your contact partner or directly with Richard Wolf GmbH.

## WORKING ELEMENTS

FOR  MONOPOLAR RESECTOSCOPES  
TELESCOPE 4 MM, 30°, 12°







		Handle variants	cutting	Product no.
<p><b>Active working element mono 12/30°</b></p> <p>Cut is made against spring pressure</p>		closed	active	<b>8674205</b>
<p><b>Active working element mono 12/30°</b></p> <p>Cut is made against spring pressure</p>		closed with comfort thumb rest		<b>8674234</b>
<p><b>Passive working element mono 12/30°</b></p> <p>Cut is made with spring pressure</p>		open	passive	<b>8674224</b>
<p><b>Passive working element mono 12/30°</b></p> <p>Cut is made with spring pressure</p>		closed		<b>8674225</b>

Recommended accessories		Product no.
<p><b>Rubber cap, red (PACK = 5 PCS)</b></p>	for sealing off the electrode clamping mechanism on the working element	<b>8874</b>
<p><b>Thumb ring</b> with relatively large inner diameter</p>		<b>15008.159</b>

# ELECTRODES

FOR  MONOPOLAR RESECTOSCOPES  
TELESCOPE 4 MM, 30°, 12°

## 12°/30°, for multiple use, monopolar

	Designation	Bracket	for sheath sizes [in Fr]		Color coding		Model
			CI	22/24	Fork	Stem	
	Cutting electrode mono 22 FR 12/30°	Loop round Ø 0.35 mm	•		green	dark gray	86782235
	Coag. electrode mono 22–24 FR 12/30°	Roll	•		green	dark gray	86782201
	Coag. electrode mono 22–24 FR 12/30°	Sphere	•		green	dark gray	86782202
	Coag. electrode mono 22–24 FR 12/30°	Button	•		green	dark gray	86782203
	Knife electrode mono 22–24 FR 12/30°	Knife	•		green	dark gray	86782204
	Hook electrode mono 22–24 FR 12/30°	Hook	•		green	dark gray	86782205
	Wing electrode mono 22 FR 12/30°	Wing (bracket profile, flat)	•		green	dark gray	86782206

- suitable for corresponding sheath size
- CI** = continuous irrigation

### Recommended accessories

**Protective sterilization sleeve**  
for connection to max. 5 electrodes, reusable





Product no.

**8428.901**

## DISPOSABLE ELECTRODES

FOR  MONOPOLAR RESECTOSCOPES  
TELESCOPE 4 MM, 30°, 12°

### 12°/30° disposable, sterile\*, monopolar

	Designation	Bracket	for sheath sizes [in Fr]		Color coding		Model
			CI	22/24	Fork	Stem	
	<b>Cutting electrode mono 22 FR 12/30°</b> (PACK = 10 PCS)	Loop round Ø 0.35 mm		•	green	transparent	46782235
	<b>Cutting electrode mono 22 FR 12/30°</b> (PACK = 10 PCS)	Loop round Ø 0.25 mm		•	green	transparent	46782225
	<b>Coag electrode mono 22-24 FR 12/30°</b> (PACK = 5 PCS)	Roll		•	green	transparent	46782201
	<b>Coag electrode mono 22-24 FR 12/30°</b> (PACK = 5 PCS)	Sphere		•	green	transparent	46782202
	<b>Coag electrode mono 22-24 FR 12/30°</b> (PACK = 5 PCS)	Button		•	green	transparent	46782203
	<b>Knife electrode mono 22-24 FR 12/30°</b> (PACK = 5 PCS)	Knife		•	green	transparent	46782204
	<b>Hook electrode mono 24 FR 12/30°</b> (PACK = 5 PCS)	Hook		•	green	transparent	46782205

- suitable for corresponding sheath size
- \* in individual sterile packaging
- CI** = continuous irrigation

# FLEXIBLE FIBER HYSTEROSCOPE

2.5 MM/7.5 FR

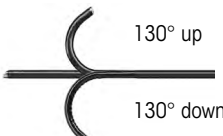



130° up  
130° down

7305.782  
included in scope of delivery



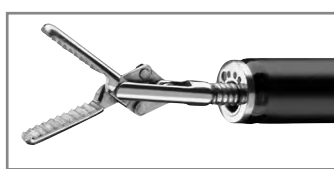



	Outer Ø	Working channel	WL	TL	Product no.
<b>Fiber Hysteroscope</b> <b>Ø 2.5 mm WL 200 mm</b> Slanted distal tip articulation +130/-130° direction of view 0°, angle of view 60°	2.5 mm 7.5 Fr /Fr	1.2 mm 3.6 Fr	200 mm	450 mm	<b>7325.122</b>
on request					
	<b>Flex. grasping forceps Ø 1 mm WL 600 mm,</b> rippled		600 mm	736 mm	<b>7223.65</b>

Recommended accessories	Product no.
<b>Sterilization basket for flexible endoscopes</b>	(W x H x D): 448 x 288 x 106 mm  <b>33016</b>
<b>Fiber light cable bndl</b> consisting of: Fiber light cable Ø 1.6 mm TL 1.8 m (80661618), projector-side adapter (809.507), and endoscope-side adapter (809509)	Ø 2.5 mm, 2.3 m long  <b>806616181</b>

# FLUID CONTROL 2225

## SUCTION IRRIGATION PUMP



core

		Product no.
FLUID CONTROL 2225 <b>Irrigation pump for HYS/URO/LAP</b>	Fluid management for flushing irrigation fluids into the uterus , as well as the upper and lower urinary tract, and for suction and irrigation in the abdomen	<b>2225001</b>
FLUID CONTROL 2225 <b>Irrigation pump for HYS/URO/LAP bndI</b>	consisting of: Irrigation pump for HYS/URO/LAP (2225001) Power cable (2440.03)	<b>22250011</b>
<b>also:</b>		
<b>Balancing module</b>	for hysteroscopy and endourology, fluid management for fluid balancing in combination with FLUID CONTROL 2225, mobile stand with integrated weighing cells and space for up to 4 irrigation fluid bags	<b>2225023</b>

# FLUID CONTROL 2225

## SUCTION IRRIGATION TUBE SETS

Irrigation			Product no.
Accessories – reusable	Tube set with piercing spike	with Luer-Lock connection, autoclavable, incl. 10 spare membranes, reusable for 20 reprocessing cycles	<b>8171223</b>
	Irrigation tube set with piercing spike, L 3 m	(PACK = 10 PCS), with Luer-Lock connection, sterile, disposable product	<b>4171223</b>
Accessories – disposable	Tube set with CARE-LOCK, L 3 m	(PACK = 10 PCS), sterile, disposable product	<b>4171224</b>
	Suction irrigation tube set	(PACK = 10 PCS), with piercing spike, sterile disposable product, PVC	<b>4171225</b>
	Day irrigation tube set	(PACK = 10 PCS), sterile, disposable product, PVC	<b>4171226</b>
	Patient irrigation tube set, sterile	(PACK = 10 PCS), with Luer-Lock connection, sterile, disposable product, PVC	<b>4171227</b>
<i>Note: Day tube and patient tube can only be used together. A new patient tube is required for each patient – the day tube can be used for up to 20 patients.</i>			

Suction			Product no.
Accessories – reusable	Tube set for vacuum, incl. filter	with integrated hygiene filter, PACK = 10 PCS, service life: 30 days (connected to irrigation pump)	<b>2206207</b>
	Irrigation tube	L 1.2 m, with Luer-Lock, for suction irrigation handle 8385901 and tube set 8171223 or 8170223	<b>817123</b>
	Suction tube L 3 m	for suction irrigation handle 8385901	<b>8171402</b>
	Secretion container, 2 l	2 liters, with lid	<b>8170.655</b>
	Secretion container, 2 l	2 liters, no lid	<b>8170.6551</b>
Accessories – disposable	Secretion container, 2.5 l	2.5 liters	<b>41706566</b>
	Secretion container bndl consisting of:	Secretion container 2.5 l (41706566) and secretion bag (PACK = 90 PCS) (41706564)	<b>4170657</b>
	Tube set for suction (2 connections)	sterile, disposable product, (PACK = 10 PCS) for connecting instruments to collecting container	<b>T0503-01</b>
	Angled 90° plug-in coupling	(PACK = 10 PCS) For connecting vacuum tube 2206207 to disposable container systems	<b>0771019</b>



# FLUID CONTROL 2225

## CABLE ACCESSORIES

		Product no.
Patch cable, RJ45 SFTP, 0.5 m	Cable length 0.5 m	<b>72325378</b>
Patch cable, RJ45 HRS TM11, 1.0 m	Cable length 1.0 m	<b>72325429</b>
Patch cable, RJ45 S/FTP CAT.6 10 m	Cable length 10 m	<b>72325434</b>
Plastic caps for network socket	(PACK = 8 PCS)	<b>5592105</b>
Power cable	Cable length 3 m	<b>2440.03</b>

# TECHNICAL DATA

## FLUID CONTROL 2225

FLUID CONTROL 2225		2225001
<b>Device properties</b>		
Operating conditions		+10°C to +40°C, 30% to 75% rel. humidity, 70 to 106 kPa atmospheric pressure 3,000 m max. altitude above sea level
Storage and transport conditions		- 20°C to + 60°C, 10% to 90% rel. humidity 70 to 106 kPa atmospheric pressure
<b>Power supply</b>		
Mains + frequency		100–240 V~, 50/60 Hz
Power consumption	100 V/60 Hz	110 VA
	240 V/50 Hz	120 VA
Current rating	100 V/60 Hz	1.10 A
	240 V/50 Hz	0.50 A
Fuse		T 3.15 AH, 250 V
<b>Regulatory standards</b>		
Protection class (I, II)		I
Electromagnetic compatibility (EMC)		EN 60601-1/IEC 60601-1 EN 60601-1-2/IEC 60601-1-2
Medical Devices Directive 93/42/EEC		Class IIb
Housing protection rating (IP code)		IP21
Protection against electric shock		Type BF applied part
Degree of protection in the presence of flammable mixtures		Device is not protected against explosions (do not operate this device in explosive atmospheres)
Maximum suction vacuum		-60 kPa
<b>Dimensions and weights</b>		
Weight		8.8 kg
Dimensions (W x H x D)		300 mm x 157 mm x 436 mm

Relevant application parameters	
Nominal flow range	Hysteroscopy: 800 ml/min (max. flow, not adjustable) Endourology: 10–800 ml/min (max. flow) Laparoscopy: 0.1–1.8 l/min (max. flow)
Suction power	max. 2 l/min
Starting nominal pressure range	Hysteroscopy: 15–200 mmHg Endourology: 15–90 mmHg/20–120 cmH2O Laparoscopy: 300 mmHg (not adjustable)
Pressure	0–300 mmHg
Deficit	-9,990 to +9,990 ml/0 to 99.9 l

# TECHNICAL DATA

## FLUID CONTROL 2225

<b>Balancing module</b>		<b>2225023</b>
<b>Device properties</b>		
Operating conditions	+10°C to +40°C, 30% to 75% rel. humidity, 70 to 106 kPa atmospheric pressure 3,000 m max. altitude above sea level	
Storage and transport conditions	- 20°C to + 60°C, 10% to 90% rel. humidity 70 to 106 kPa atmospheric pressure	
<b>Regulatory standards</b>		
Electromagnetic compatibility (EMC)	EN 60601-1/IEC 60601-1 EN 60601-1-2/IEC 60601-1-2	
Housing protection rating (IP code)	IP21	
Maximum load of container scale	16 kg/4 containers of 3 l each	
Maximum load of bag scale	23 kg/4 bags of 5 l each	
<b>Dimensions and weights</b>		
Weight	15.4 kg	
Dimensions (W x H x D)	618 mm x 1,064 mm x 618 mm	

# HF CONNECTION CABLE MONO 815xxx

DEVICES / ACCESSORIES

10

Instrument connector	Device connector		Product no.
<b>WOLF Resectoscopes</b> 	 <p>ERBE (ACC/ICC/IO)/BOWA (EU) R. Wolf HF surgical generator 400 kHz 2260002</p>	HF connection cable mono L 3 m	<b>815.032</b>
		HF connection cable mono L 5 m	<b>815.052</b>
	 <p>ERBE (T series)</p>	HF connection cable mono L 3 m	<b>815.132</b>
		HF connection cable mono L 5 m	<b>815.152</b>
<b>HF electrodes, monopolar</b> 	 <p>Martin (M-version)/Berchtold/ Aesculap</p>	HF connection cable mono L 3 m	<b>815.031</b>
		HF connection cable mono L 5 m	<b>815.051</b>
	 <p>Bovie/Valleylab/Erbe (Int.)/ BOWA (Int.) R. Wolf HF surgical generator 400 kHz 2260001</p>	HF connection cable mono L 3 m	<b>815.033</b>
		HF connection cable mono L 5 m	<b>815.053</b>
	 <p>BOWA (Int./EU) Eschmann and other devices with 4 mm plugs R. Wolf HF surgical generator 400 kHz 2260001</p>	HF connection cable mono L 3 m	<b>815.034</b>
		HF connection cable mono L 5 m	<b>815.054</b>

1123 | Subject to modifications. Please note that some products may not be available in all countries. Please always take note of the information that is provided with the product. For more detailed information, please consult with your contact partner or directly with Richard Wolf GmbH.









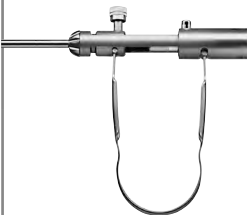

# HF CONNECTION CABLE MONO 8106XXX

Instrument connector	Device connector		Product no.
<p><b>WOLF Instruments/surgical generator</b></p> 		<p>HF connection cable mono L 3 m</p>	<p><b>8106.032</b></p>
	<p>ERBE (ACC/ICC/IO)/BOWA (EU) R. Wolf HF surgical generator 400 kHz 2260002</p>	<p>HF connection cable mono L 5 m</p>	<p><b>8106.052</b></p>
		<p>HF connection cable mono L 3 m</p>	<p><b>8106.132</b></p>
	<p>ERBE (T series)</p>	<p>HF connection cable mono L 5 m</p>	<p><b>8106.152</b></p>
<p><b>HF electrodes, monopolar</b></p> 		<p>HF connection cable mono L 3 m</p>	<p><b>8106.031</b></p>
	<p>Martin (M-version)/Berchtold/ Aesculap</p>	<p>HF connection cable mono L 5 m</p>	<p><b>8106.051</b></p>
		<p>HF connection cable mono L 3 m</p>	<p><b>8106.033</b></p>
	<p>Bovie/Valleylab/Erbe (Int.)/ BOWA (Int.) R. Wolf HF surgical generator 400 kHz 2260001</p>	<p>HF connection cable mono L 5 m</p>	<p><b>8106.053</b></p>
		<p>HF connection cable mono L 3 m</p>	<p><b>8106.034</b></p>
	<p>BOWA (Int./EU) Eschmann and other devices with 4 mm plugs R. Wolf HF surgical generator 400 kHz 2260001/2260002</p>	<p>HF connection cable mono L 5 m</p>	<p><b>8106.054</b></p>

# BIPO HF CONNECTION CABLE





8108xxx

DEVICES / ACCESSORIES

Instrument connector	Device connector		Product no.	
<p><b>WOLF Bipolar forceps</b></p> 	 <p>ERBE (ACC/ICC/T)/BOWA (EU) R. Wolf HF surgical generator 400 kHz 2260001/2260002</p>	HF connection cable bipo; L 3 m	<b>8108.032</b>	
		HF connection cable bipo; L 5 m	<b>8108.052</b>	
	 <p>International / 2-pin Valleylab R. Wolf HF surgical generator 400 kHz 2260001/2260002</p>	HF connection cable bipo; L 3 m	<b>8108.033</b>	
		HF connection cable bipo; L 5 m	<b>8108.053</b>	
	 <p>WOLF/Martin (M-version)/ Berchtold/Aesculap</p>	HF connection cable bipo; L 3 m	<b>8108.031</b>	
		HF connection cable bipo; L 5 m	<b>8108.051</b>	
	 <p>EMC Dolley</p>	HF connection cable bipo; L 3 m	<b>8108035</b>	
	<p><b>Bipolar tweezers connection</b></p> 	 <p>ERBE (ACC/ICC/T)/BOWA (EU) R. Wolf HF surgical generator 400 kHz 2260001/2260002</p>	HF connection cable bipo; L 3 m	<b>8108.132</b>
			HF connection cable bipo; L 5 m	<b>8108.152</b>
 <p>International / 2-pin Valleylab R. Wolf HF surgical generator 400 kHz 2260001/2260002</p>		HF connection cable bipo; L 3 m	<b>8108.133</b>	
		HF connection cable bipo; L 5 m	<b>8108.153</b>	
 <p>Martin (M-version)/Berchtold/ Aesculap</p>		HF connection cable bipo; L 3 m	<b>8108.131</b>	
		HF connection cable bipo; L 5 m	<b>8108.151</b>	
 <p>EMC Dolley</p>		HF connection cable bipo; L 3 m	<b>8108135</b>	

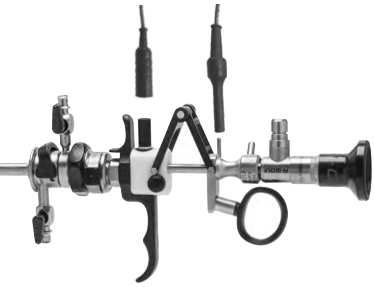

1123 | Subject to modifications. Please note that some products may not be available in all countries. Please always take note of the information that is provided with the product. For more detailed information, please consult with your contact partner or directly with Richard Wolf GmbH.

## HF CONNECTION CABLE BIPO FOR RESECTION IN SALINE SOLUTION

Instrument connector	Device connector		Product no.
<p><b>WOLF S(a)line resectoscopes</b></p> 	 Erbe VIO 300D	<p><b>Bipolar cable; TUR/TCR; WOLF</b></p> <p>MF plug; L 4 m</p>	<p><b>20196-119</b></p>
	 Erbe VIO 3	<p><b>BIPOLAR CABLE; MF-U</b></p> <p>MF plug; L 4.5 m</p>	<p><b>21196-119</b></p>
	 KLS Martin	<p><b>HF connection cable bipo; L 3 m</b></p>	<p><b>8108.231</b></p>
		<p><b>HF connection cable bipo; L 5 m</b></p>	<p><b>8108.251</b></p>
	 R. Wolf HF surgical generator 400 kHz 2260001/2260002		<p><b>8108233</b></p>
		<p><b>HF connection cable bipo; L 5 m</b></p>	<p><b>8108253</b></p>

1123|| Subject to modifications. Please note that some products may not be available in all countries. Please always take note of the information that is provided with the product. For more detailed information, please consult with your contact partner or directly with Richard Wolf GmbH.

# MONO HF NEUTRAL ELECTRODE CABLE

Instrument connector	Device connector		Product no.
<p><b>2-pole neutral electrode</b></p> 	 <p>R. Wolf HF surgical generator 400 kHz 2260001/2260002</p>	<p><b>Mono HF neutral electrode cable, L 4.5 m</b></p>	<p><b>2260031</b></p>

1123 | Subject to modifications. Please note that some products may not be available in all countries. Please always take note of the information that is provided with the product. For more detailed information, please consult with your contact partner or directly with Richard Wolf GmbH.



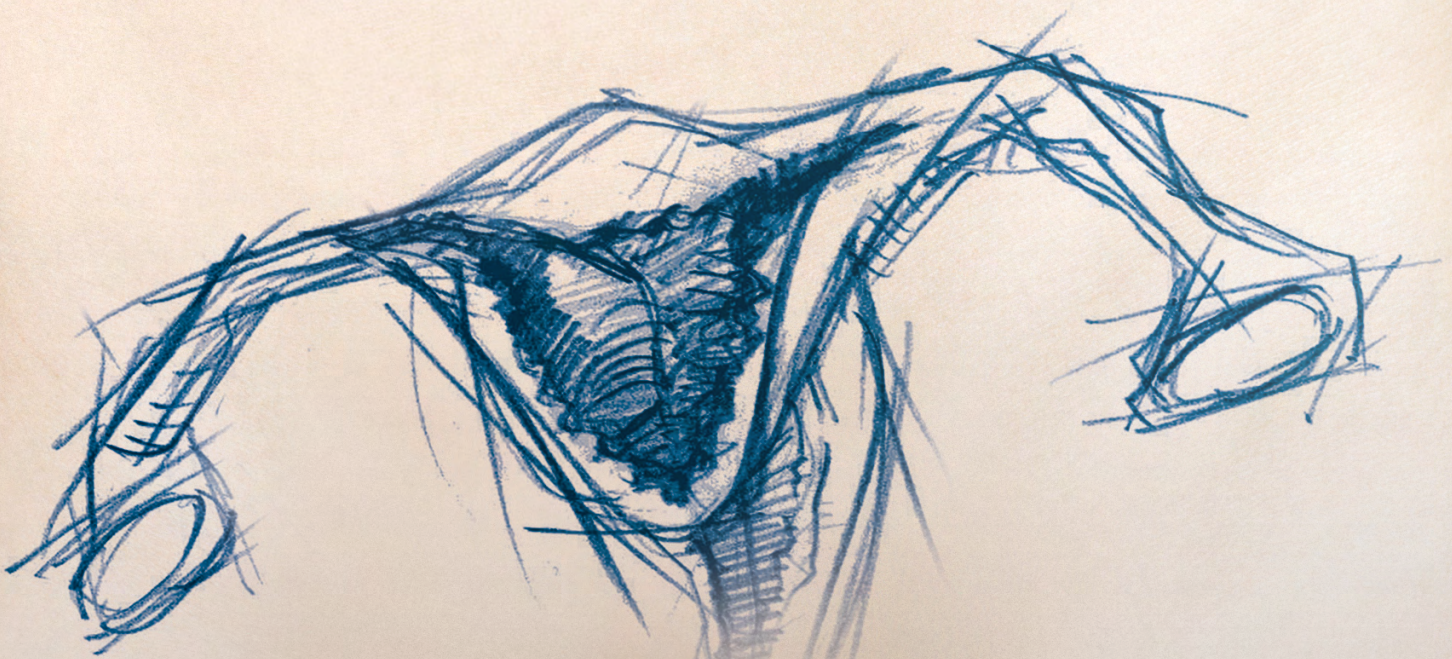

## INTERDISCIPLINARY APPLICATIONS

CYSTO-URETHROSCOPY

## INTERDISCIPLINARY APPLICATIONS

1

---

**CYSTO-URETHROSCOPE 8650 FOR TELESCOPE 4 MM, 0°, 5°, 30°, 70° (TVT)**

---

2

---

**CYSTOSCOPE 14, 17 FR, 25°**

---

# CYSTO-URETHROSCOPE 8650

*E-line*

FOR TELESCOPE 4 MM, 0°, 12°, 30°, 70° AND ADAPTERS

CYSTO-URETHROSCOPE

1

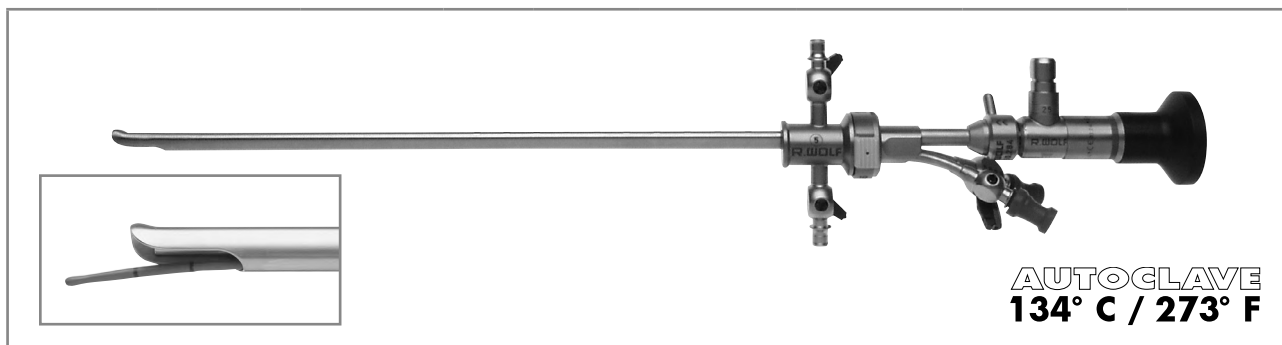

Sheaths and obturators						Adapters		
------------------------	--	--	--	--	--	----------	--	--



Sheath for cystoscope with obturator	Sheath for cystoscope single	Obturator for cystoscope single	Fr	Color coding	Capacity in Fr	Adapter for cystoscope TL 60 mm	Adapter for cystoscope TL 60 mm	Adapter for cystoscope TL 60 mm
8650.0141	8650.0145	8650.0147	16 FR	yellow	1x5*	8650.254	8650.264	8650.284
8650.0241	8650.0245	8650.0247	17.5 FR	green	1x5 oder 2x4			
8650.0341	8650.0345	8650.0347	19.5 FR	red	1x7 oder 2x5			
8650.0441	8650.0445	8650.0447	21 FR	blue	1x10 oder 2x6			
8650.0541	8650.0545	8650.0547	23 FR	white	1x12 oder 2x7			
8650.0641	8650.0645	8650.0647	25 FR	black	1x5			

also: 

	Direction of view	Ø	WL	TL	Product no.
Telescope 0° Ø 4 mm NL 298 mm	0°	4 mm	298 mm	365 mm	8650.414
Telescope 12° Ø 4 mm NL 297 mm	12°		297 mm	363 mm	8654.431
Telescope 30° Ø 4 mm NL 300 mm	30°		300 mm	364 mm	8654.422
Telescope 70° Ø 4 mm NL 302 mm	70°		302 mm	364 mm	8650.415

Recommended accessories	Product no.
-------------------------	-------------

Perforated basket for standard telescope 2	Internal dimensions (W x H x D): 454 x 52 x 40 mm External dimensions (W x H x D): 481 x 54 x 59 mm	38016
Fiber light cable bndl consisting of: Fiber light cable (80662523), projector-side adapter (8095.07), and endoscope-side adapter (809509)	Ø 2.5 mm, 2.3 m long	806625231





1123|| Subject to modifications. Please note that some products may not be available in all countries. Please always take note of the information that is provided with the product. For more detailed information, please consult with your contact partner or directly with Richard Wolf GmbH.

# CYSTO-URETHROSCOPE 8650

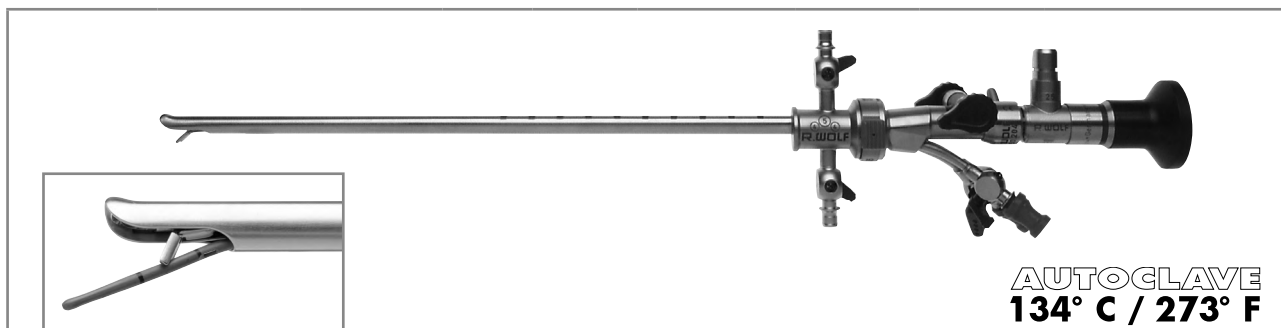
*E-line*

FOR TELESCOPE 4 MM, 30°, 70° AND INSERTS WITH ALBARRAN LEVER



Sheaths and obturators						Inserts with Albarran lever	
							
					1 instrument port	2 instrument ports	
Sheath for cystoscope with obturator	Sheath for cystoscope single	Obturator for cystoscope single	Fr	Color coding	Capacity in Fr	Working insert for cystoscope 30/70	Working insert for cystoscope 0/30/70
8650.0241	8650.0245	8650.0247	17.5 FR	yellow	1 x 5 or 2 x 4	<b>8650.214</b>	<b>8650.204</b>
8650.0341	8650.0345	8650.0347	19.5 FR	green	1 x 7 or 2 x 5		
8650.0441	8650.0445	8650.0447	21 FR	red	1 x 10 or 2 x 6		
8650.0541	8650.0545	8650.0547	23 FR	blue	1 x 12 or 2 x 7		
also: 							
			Direction of view	Ø	WL	TL	Product no.
Telescope 30° Ø 4 mm NL 300 mm			30°	4 mm	300 mm	364 mm	<b>8654.422</b>
Telescope 70° Ø 4 mm NL 302 mm			70°	4 mm	302 mm	364 mm	<b>8650.415</b>

Recommended accessories	Product no.
<b>Perforated basket for standard telescope 2</b>	Internal dimensions (W x H x D): 454 x 52 x 40 mm External dimensions (W x H x D): 481 x 54 x 59 mm <b>38016</b>
<b>Fiber light cable bndl</b> consisting of: Fiber light cable (80662523), projector-side adapter (8095.07), and endoscope-side adapter (809509)	Ø 2.5 mm, 2.3 m long <b>806625231</b>

||23|| Subject to modifications. Please note that some products may not be available in all countries. Please always take note of the information that is provided with the product. For more detailed information, please consult with your contact partner or directly with Richard Wolf GmbH.

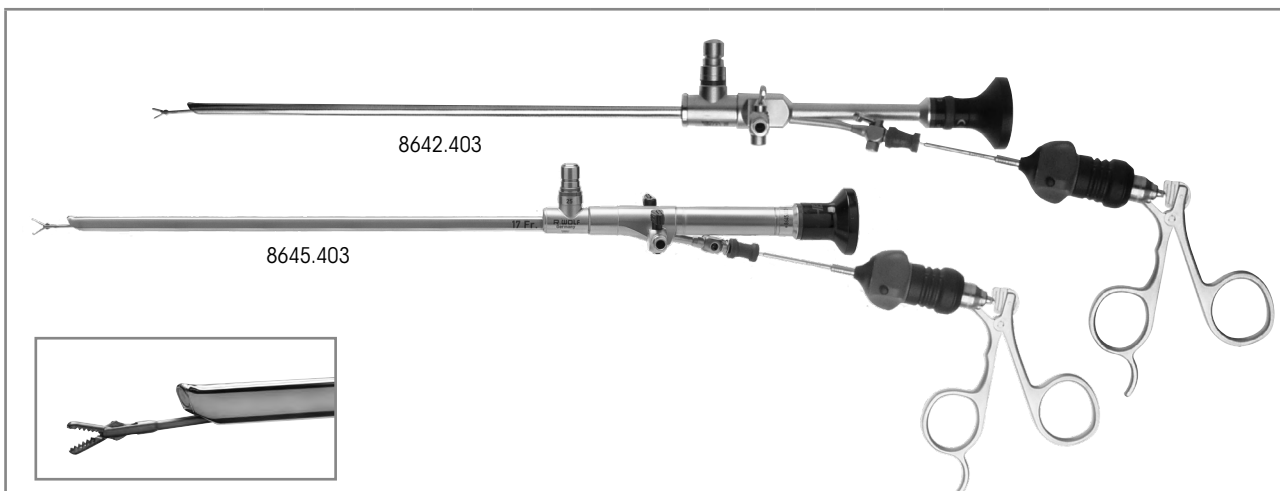

# ATRAUMATIC COMPACT CYSTO-URETHROSCOPE

## 14/17 FR, 25° AND ADAPTERS



	Viewing direction	WL	TL	Sheath	Working channel		Product no.
					for auxiliary instruments	Form	
<b>Cystoscope 25°, 14 FR, WL 218 mm</b> with straight eyepiece, atraumatically shaped tip	25°	218 mm	358 mm	14 Fr	to 5 Fr	oval	<b>8642.403</b>
<b>Cystoscope 25°, 17 FR, WL 224 mm</b> with straight eyepiece, atraumatically shaped tip	25°	224 mm	364 mm	17 Fr	to 7 Fr	oval	<b>8645.403</b>

also:

		WL	TL	Fr	Product no.
	Flex. biopsy forceps 7 FR WL 375 mm	375 mm	490 mm	7	<b>829.07</b>
	Flex. biopsy forceps 5 FR WL 315 mm	315 mm	465 mm	5	<b>829.05</b>
	Flex. grasping forceps 7 FR WL 365 mm	365 mm	515 mm	7	<b>828.07</b>
	Flex. grasping forceps 5 FR WL 315 mm	315 mm	465 mm	5	<b>828.05</b>
	Flex. scissors 7 FR WL 375 mm	375 mm	490 mm	7	<b>830.07</b>
Electrode shape: Button	Coagulation electrode mono 6 FR WL 400 mm	400 mm	-	6	<b>823.06</b>
	Coagulation electrode mono 5 FR WL 400 mm	400 mm	-	5	<b>823.05</b>

Recommended accessories		Product no.
<b>Perforated basket for cysto-urethroscope</b>	Internal dimensions (W x H x D): 435 x 54 x 73 mm External dimensions (W x H x D): 451 x 64 x 80 mm	<b>38013</b>
<b>Fiber light cable bndl</b> consisting of: Fiber light cable (80662523), projector-side adapter (8095.07), and endoscope-side adapter (809509)	Ø 2.5 mm, 2.3 m long	<b>806625231</b>

