

**GENERAL SURGERY**

## GENERAL SURGERY

1

---

**LAPAROSCOPY**

---

2

---

**TRANSANAL ENDOSCOPIC MICROSURGERY**

---

3

---

**PROCTO-REKTOSCOPY**

---

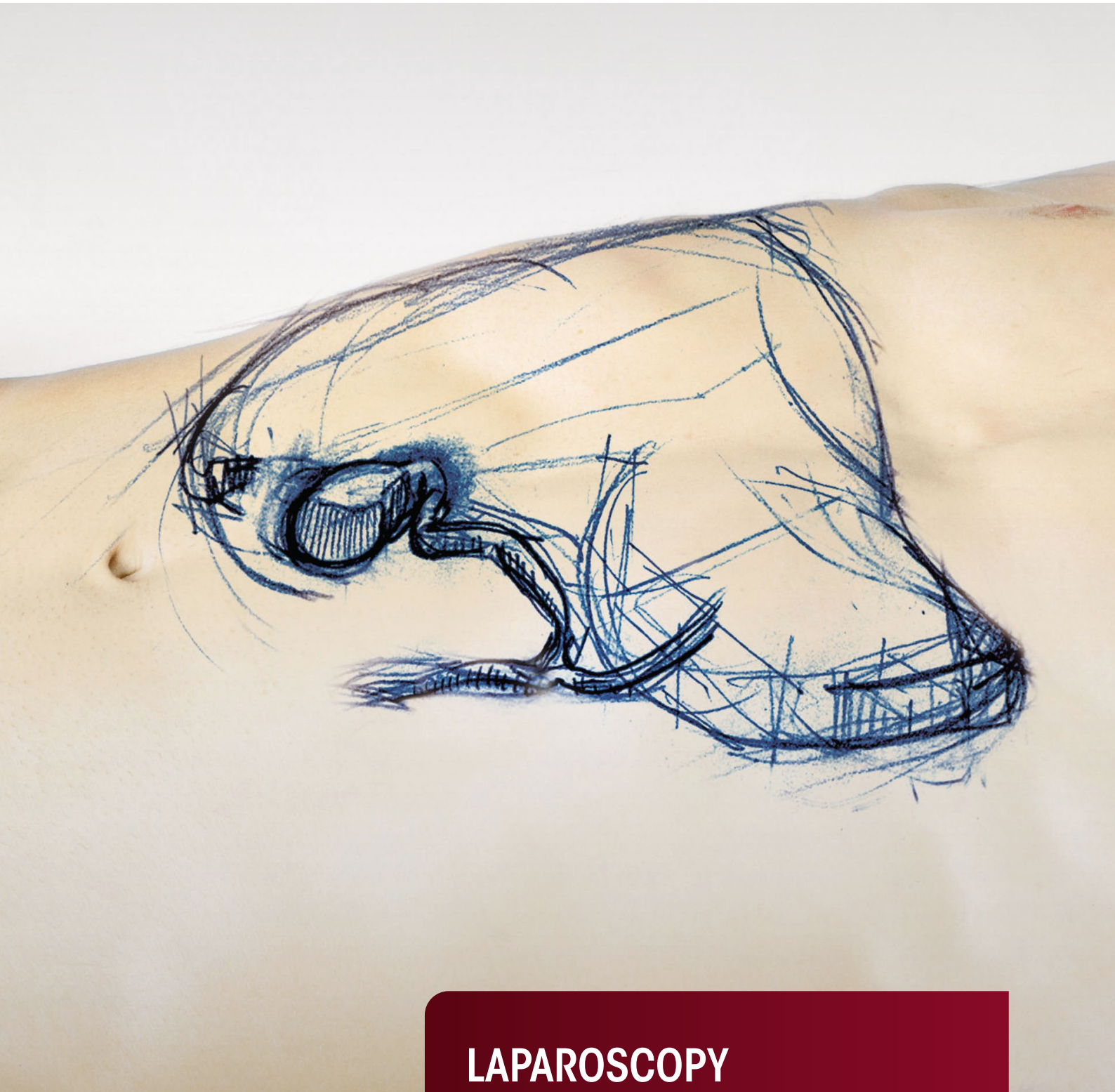

# LAPAROSCOPY

## LAPAROSCOPY

1

**BASIC SETS**

2

**TELESCOPES**

3

**TROCAR SLEEVES / DILATION / EXTRACTION / REDUCING SLEEVES**

4

**ERAGONMODULAR GRASPING FORCEPS / DISSECTORS / BIOPSY FORCEPS / SCISSORS**

5

**GRASPING FORCEPS**

6

**BIPOLAR FORCEPS AND SCISSORS**

7

**HF ELECTRODES (MONOPOLAR/BIPOLAR)**

8

**MULTIFUNCTIONAL SUCTION IRRIGATION SYSTEM**

9

**TISSUE RETRACTOR**

10

**CLIP APPLICATOR**

11

**NEEDLE HOLDER / KNOT PUSHER / FASCIA CLOSURE**

12

**CANNULAS / SURGICAL PROBES / MYOMA DRILLS**

13

**DEVICES / ACCESSORIES**

14

**CHOLEDOCHOSCOPY**

15

**TRAINING MODELS**

## BASIC SET

### FOR ALL LAPAROSCOPIC PROCEDURES

Product	Product no.	Quantity	Catalog / Section
Insufflator 45 EVAC + HEAT bndl	<b>22350311</b>	1	Laparoscopy / 14
VERES cannula Ø 2.1 mm WL 152 mm	<b>8302.12</b>	1	Laparoscopy / 3
LAP suction irrigation pump bndl	<b>22160011</b>	1	Laparoscopy / 14
LED light source ENDOLIGHT LED 2.1 bndl	<b>51630011</b>	1	Imaging / Light sources
Fiber light cable		1	Imaging / Light cables
ENDOCAM Logic HD	<b>5525</b>	1	Imaging / ENDOCAM
Monitors		1	Imaging / Monitors
Device cart		1	Imaging / Device cart

# BASIC SET

## FOR LAPAROSCOPIC CHOLECYSTECTOMY

Product	Product no.	Quantity	Catalog / Section
Telescope 30° Ø 10 mm WL 307 mm	<b>8934.432</b>	1	Laparoscopy / 2
and/or			
Telescope 0° Ø 10 mm WL 307 mm	<b>8934.431</b>	1	Laparoscopy / 2
Fiber light cable bndl	<b>806650231</b>	1	Laparoscopy / 2
Trocar sleeve, slanted, capacity 5.5 mm WL 100 mm	<b>8921.013</b>	2-3	Laparoscopy / 3
and/or			
Trocar sleeve, straight, capacity 5.5 mm WL 102 mm	<b>8919.351</b>	2-3	Laparoscopy / 3
Trocar sleeve, slanted, capacity 10 mm WL 100 mm	<b>8923.013</b>	2	Laparoscopy / 3
Guide rod 5.5 mm TL 500 mm	<b>8923.921</b>	1	Laparoscopy / 3
Instrument sleeve 10 mm WL 170 mm	<b>8385.50</b>	1	Laparoscopy / 3
VERES cannula Ø 2.1 mm WL 152 mm	<b>8302.12</b>	1	Laparoscopy / 3
Multifunctional suction irrigation system			
Suction irrigation tube Ø 5 mm WL 310 mm	<b>8383.911</b>	1	Laparoscopy / 8
Suction irrigation handle	<b>8385.901</b>	1	Laparoscopy / 8
Sealing cap	<b>8385.902</b>	1	Laparoscopy / 8
<b>ERAGONmodular</b>			
Atraumatic grasping forceps Ø 5 mm bndl	<b>83932925</b>	1	Laparoscopy / 4
Atraumatic grasping forceps mono Ø 5 mm bndl	<b>83931817</b>	2	Laparoscopy / 4
Maryland dissector forceps mono Ø 5 mm bndl	<b>83932817</b>	1	Laparoscopy / 4
Metzenbaum scissors Ø 5 mm bndl	<b>83930417</b>	1	Laparoscopy / 4
Grasping forceps Ø 10 mm bndl	<b>83952048</b>	1	Laparoscopy / 4
Plate-shaped grasping forceps Ø 10 mm bndl	<b>83952347</b>	1	Laparoscopy / 4
<b>Hook electrode mono Ø 5 mm WL 340 mm</b>			
Clip applicator Ø 10 mm WL 340 mm	<b>8389.911</b>	1	Laparoscopy / 10
Ethicon® Ligaclips® (PACK= 108 PCS)	<b>8389.915</b>	1	Laparoscopy / 10
Needle forceps Ø 2.45 mm WL 160 mm	<b>8756.201</b>	1	Laparoscopy / 11
Sealing cone Ø 12-15 mm	<b>8943.915</b>	1	Laparoscopy / 11
Monopolar HF cable	<b>8106</b>	2	Laparoscopy / 14

# BASIC SET

## FOR LAPAROSCOPIC CHOLECYSTECTOMY

Product	Product no.	Quantity	Catalog / Section
Also on request:			
Telescope 30° Ø 5.3 mm WL 303 mm	<b>8935442</b>	1	Laparoscopy / 2
Trocar sleeve, slanted, capacity 5.5 mm WL 100 mm	<b>8921.013</b>	1	Laparoscopy / 3
Trocar tip sharp size 5.5 mm WL 169 mm	<b>8921.113</b>	1	Laparoscopy / 3
ERAGONmodular			
Atraumatic grasping forceps mono Ø 5 mm bndl	<b>83931957</b>	1	Laparoscopy / 4
Biopsy forceps mono Ø 5 mm bndl	<b>83930937</b>	1	Laparoscopy / 4
Dissector forceps Ø 10 mm bndl	<b>83952268</b>	1	Laparoscopy / 4
ERAGONbipolar			
Grasping forceps bipo Ø 5.5 mm bndl	<b>839300312</b>	1	Laparoscopy / 6

In addition to laparoscopic choledochus revision			
Grasping forceps Ø 5 mm WL 295 mm	<b>8383311</b>	1	Laparoscopy / 5

## BASIC SET

### FOR LAPAROSCOPIC APPENDECTOMY

Product	Product no.	Quantity	Catalog / Section
Telescope 30° Ø 10 mm WL 307 mm	<b>8934.432</b>	1	Laparoscopy / 2
and/or			
Telescope 0° Ø 10 mm WL 307 mm	<b>8934.431</b>	1	Laparoscopy / 2
Fiber light cable bndl	<b>806650231</b>	1	Laparoscopy / 2
Trocar sleeve, slanted, capacity 10 mm WL 100 mm	<b>8923.013</b>	2	Laparoscopy / 3
Trocar tip sharp size 10 mm	<b>8923.113</b>	2	Laparoscopy / 3
and/or			
Trocar sleeve, straight, capacity 5.5 mm WL 102 mm	<b>8919.351</b>	2-3	Laparoscopy / 3
Trocar tip sharp size 5.5 mm WL 144 mm	<b>8919.3512</b>	2-3	Laparoscopy / 3
Trocar sleeve, slanted, capacity 5.5 mm WL 100 mm	<b>8921.013</b>	2-3	Laparoscopy / 3
Trocar tip sharp size 5.5 mm WL 169 mm	<b>8921.113</b>	2-3	Laparoscopy / 3
Guide rod 5.5 mm TL 500 mm	<b>8923.921</b>	1	Laparoscopy / 3
Instrument sleeve 10 mm WL 170 mm	<b>8385.50</b>	1	Laparoscopy / 3
<b>ERAGONmodular</b>			
Grasping forceps mono Ø 5 mm bndl	<b>83932877</b>	1	Laparoscopy / 4
Atraumatic grasping forceps mono Ø 5 mm bndl	<b>83931817</b>	2	Laparoscopy / 4
Maryland dissector forceps mono Ø 5 mm bndl	<b>83932817</b>	1	Laparoscopy / 4
Metzenbaum scissors Ø 5 mm bndl	<b>83930417</b>	1	Laparoscopy / 4
Grasping and dissector forceps 5 mm	<b>83932827</b>	1	Laparoscopy / 4
<b>ERAGONbipolar</b>			
Grasping forceps bipo Ø 5.5 mm bndl	<b>839300312</b>	1	Laparoscopy / 6
<b>Multifunctional suction irrigation system</b>			
Suction irrigation tube Ø 5 mm WL 310 mm	<b>83839.11</b>	1	Laparoscopy / 8
Suction irrigation handle	<b>8385.901</b>	1	Laparoscopy / 8
Sealing cap	<b>8385.902</b>	1	Laparoscopy / 8
<b>Surgical probe Ø 5 mm WL 328 mm</b>			
Surgical probe Ø 5 mm WL 328 mm	<b>8383.66</b>	1	Laparoscopy / 12
VERES cannula Ø 2.1 mm WL 152 mm	<b>8302.12</b>	1	Laparoscopy / 3
Bipolar HF cable	<b>8108</b>	1	Laparoscopy / 14
Monopolar HF cable	<b>8106</b>	1	Laparoscopy / 14



# BASIC SET

## FOR LAPAROSCOPIC APPENDECTOMY

Product	Product no.	Quantity	Catalog / Section
Also on request:			
ERAGONmodular			
Dissector forceps mono Ø 5 mm bndl	<b>83932897</b>	1	Laparoscopy / 4
Grasping forceps mono Ø 5 mm bndl	<b>83931837</b>	2	Laparoscopy / 4
Biopsy forceps mono Ø 5 mm bndl	<b>83930917</b>	1	Laparoscopy / 4
Maryland dissector forceps Ø 10 mm bndl	<b>83952257</b>	1	Laparoscopy / 4
Clip applicator Ø 10 mm WL 340 mm	<b>8389.911</b>	1	Laparoscopy / 10
Ethicon® Ligaclips® (PACK= 108 PCS)	<b>8389.915</b>	1	Laparoscopy / 10
Introduction sleeve 10 mm WL 80 mm	<b>8389.991</b>	1	Laparoscopy / 10
Needle holder Ø 5 mm bndl	<b>8393.502</b>	1	Laparoscopy / 11

|||23 || Subject to modifications. Please note that some products may not be available in all countries. Please always take note of the information that is provided with the product. For more detailed information, please consult with your contact partner or directly with Richard Wolf GmbH.

## BASIC SET LEVD

### LAPAROSCOPIC SINGLE-CHANNEL VARICOCELE DISSECTION

Product	Product no.	Quantity	Catalog / Section
OR endoscope bndl	<b>8920.4011</b>	1	Laparoscopy / 2
Perforated basket for telescope	<b>38008</b>		Laparoscopy / 2
Fiber light cable bndl	<b>806625231</b>	1	Laparoscopy / 2
Trocar sleeve, straight, capacity 5.5 mm WL 102 mm	<b>8919.353</b>	1	Laparoscopy / 3
Optional:			
Trocar tip blunt size 5.5 mm WL 144 mm	<b>8919.3511</b>	1	Laparoscopy / 3
Trocar tip sharp size 5.5 mm WL 144 mm	<b>8919.3512</b>	1	Laparoscopy / 3
Trocar tip triangular size 5.5 mm WL 144 mm	<b>8919.3513</b>	1	Laparoscopy / 3
ERAGONmodular mini			
Universal grasping forceps Ø 3.5 mm bndl	<b>83912097</b>	1	Laparoscopy / 4
Atraumatic grasping forceps Ø 3.5 mm bndl	<b>83912087</b>	1	Laparoscopy / 4
Babcock forceps Ø 3.5 mm bndl	<b>83912107</b>	1	Laparoscopy / 4
Dissector forceps mono Ø 3.5 mm bndl	<b>83912077</b>	1	Laparoscopy / 4
Hook scissors mono Ø 3.5 mm bndl	<b>83912277</b>	1	Laparoscopy / 4
Metzenbaum scissors mono Ø 3.5 mm bndl	<b>83912247</b>	1	Laparoscopy / 4
Connection cable			
Bipolar HF cable	<b>8108</b>	1	Laparoscopy / 14
Monopolar HF cable	<b>8106</b>	1	Laparoscopy / 14

# BASIC SET

## E-MILOS

Product	Product no.	Quantity	Catalog / Section
Telescope 30° Ø 10 mm WL 307 mm	<b>8934.432</b>	1	Laparoscopy / 2
Light tube for MILOS method Ø 10 mm	<b>893420</b>	1	Laparoscopy / 2
Trocar sleeve, straight, capacity 3.5 mm WL 100 mm	<b>8903.014</b>	2	Laparoscopy / 3
Trocar tip blunt size 3.5 mm WL 169 mm	<b>8903.103</b>	2	Laparoscopy / 3
<b>ERAGONmodular mini</b>			
Handle, pistol-shaped, mono	<b>83930073</b>	4	Laparoscopy / 4
Sheath tube insulated Ø 3.5 mm SL 330 mm	<b>8391933</b>	4	Laparoscopy / 4
Dissector forceps insert Ø 3.5 mm	<b>8391222</b>	1	Laparoscopy / 4
Metzenbaum scissors insert Ø 3.5 mm	<b>8391215</b>	1	Laparoscopy / 4
Grasping forceps insert Ø 3.5 mm	<b>8391208</b>	2	Laparoscopy / 4
<b>Electrode</b>			
Hook electrode mono Ø 3.5 mm WL 310 mm	<b>8379.452</b>	1	Laparoscopy / 7
<b>ERAGONstitch</b>			
Needle holder insert Ø 3.5 mm	<b>8391506</b>	1	Laparoscopy / 11
Sheath tube Ø 3.5 mm SL 330 mm	<b>8391533</b>	1	Laparoscopy / 11
Needle holder handle, axial	<b>8393943</b>	1	Laparoscopy / 11

# BASIC SET

## MINI E-MILOS

Product	Product no.	Quantity	Catalog / Section
Telescope 30° Ø 10 mm WL 307 mm	<b>8934.432</b>	1	Laparoscopy / 2
Light tube for MILOS method Ø 10 mm	<b>893420</b>	1	Laparoscopy / 2
Trocar sleeve, straight, capacity 5.5 mm WL 100 mm	<b>8921.014</b>	2	Laparoscopy / 3
Trocar tip blunt size 5.5 mm WL 169 mm	<b>8921.103</b>	2	Laparoscopy / 3
<b>ERAGONmodular</b>			
Handle, pistol-shaped, mono	<b>83930073</b>	4	Laparoscopy / 4
Sheath tube insulated Ø 5 mm SL 330 mm	<b>8391933</b>	4	Laparoscopy / 4
Dissector forceps insert Ø 5 mm	<b>8393240</b>	1	Laparoscopy / 4
Metzenbaum scissors insert Ø 5 mm	<b>8393.041</b>	1	Laparoscopy / 4
Grasping forceps insert Ø 3.5 mm	<b>8393.181</b>	2	Laparoscopy / 4
<b>Electrode</b>			
Hook electrode mono Ø 5 mm WL 340 mm	<b>8383.423</b>	1	Laparoscopy / 7
<b>ERAGONstitch</b>			
Needle holder insert Ø 5 mm	<b>8393508</b>	1	Laparoscopy / 11
Sheath tube Ø 5 mm SL 330 mm	<b>8393533</b>	1	Laparoscopy / 11
Needle holder handle, axial	<b>8393943</b>	1	Laparoscopy / 11

# BASIC SET

## LAPAROSCOPIC BARIATRIC SURGERY

Product	Product no.	Quantity	Catalog / Section
Telescope 0° Ø 10 mm WL 305 mm	<b>8934461</b>	1	Laparoscopy / 2
Telescope 30° Ø 10 mm WL 305 mm	<b>8934462</b>	1	Laparoscopy / 2
Fiber light cable bndl	<b>806550231</b>	1	Laparoscopy / 2
Trocar sleeve, straight, capacity 5.5 mm WL 150 mm	<b>8921.016</b>	3	Laparoscopy / 3
Trocar sleeve, straight, capacity 10 mm WL 150 mm	<b>8923.016</b>	1	Laparoscopy / 3
Trocar sleeve, straight, capacity 12.5 mm WL 150 mm	<b>8924.016</b>	1	Laparoscopy / 3
<b>Optional:</b>			
Trocar tip sharp size 5.5 mm	<b>8921.115</b>	3	Laparoscopy / 3
Trocar tip sharp size 10 mm	<b>8923.115</b>	1	Laparoscopy / 3
Trocar tip sharp size 12.7 mm	<b>8924.115</b>	1	Laparoscopy / 3
Reducing adapter	<b>8923.802</b>	1	Laparoscopy / 3
<b>Multifunctional suction irrigation system</b>			
Suction irrigation tube Ø 5 mm WL 450 mm	<b>8384.911</b>	1	Laparoscopy / 8
Suction irrigation handle	<b>8385.901</b>	1	Laparoscopy / 8
Sealing cap	<b>8385.902</b>	1	Laparoscopy / 8
Suction irrigation tube set with piercing spike L 3 m	<b>4170.956</b>	1	Laparoscopy / 8
<b>ERAGONmodular</b>			
Atraumatic grasping forceps mono Ø 5 mm bndl	<b>83941817</b>	1	Laparoscopy / 4
Dissector forceps mono Ø 5 mm bndl	<b>83942407</b>	1	Laparoscopy / 4
Metzenbaum scissors mono Ø 5 mm bndl	<b>83940417</b>	1	Laparoscopy / 4
Atraumatic Grasping forceps Ø 5 mm bndl	<b>83942297</b>	1	Laparoscopy / 4
Biopsy forceps mono Ø 5 mm bndl	<b>83940917</b>	1	Laparoscopy / 4
Atraumatic Grasping forceps Ø 5 mm bndl	<b>83942507</b>	1	Laparoscopy / 4
Stapler head grasping forceps Ø 10 mm bndl	<b>83976558</b>	1	Laparoscopy / 4
Plate-shaped grasping forceps Ø 10 mm bndl	<b>83962347</b>	1	Laparoscopy / 4
Babcock forceps Ø 10 mm bndl	<b>83961877</b>	1	Laparoscopy / 4
<b>ERAGONbipolar</b>			
Maryland dissector bipo Ø 5.5 mm bndl	<b>839400322</b>	1	Laparoscopy / 6
Metzenbaum scissors bipo Ø 5.5 mm bndl	<b>839400412</b>	1	Laparoscopy / 6
<b>Electrode</b>			
Hook electrode mono Ø 5 mm WL 420 mm	<b>8384.423</b>	1	Laparoscopy / 7

## BASIC SET

### LAPAROSCOPIC BARIATRIC SURGERY

Product	Product no.	Quantity	Catalog / Section
Clip applicator Ø 10 mm WL 340 mm	<b>8389.911</b>	1	Laparoscopy / 10
Ethicon® Ligaclips® (PACK= 108 PCS)	<b>8389.915</b>	1	Laparoscopy / 10
Needle holder Ø 5 mm bndl with carbide insert	<b>8394.502</b>	1	Laparoscopy / 11
Needle holder Ø 5 mm bndl curved to the right with carbide insert	<b>8394.511</b>	1	Laparoscopy / 11
Needle forceps Ø 2.45 mm WL 160 mm	<b>8756.201</b>	1	Laparoscopy / 11
Sealing cone Ø 12–15 mm	<b>8943.915</b>	1	Laparoscopy / 11
Sealing cone Ø 10–12 mm	<b>8934.915</b>	1	Laparoscopy / 11
VERES cannula Ø 2.1 mm WL 152 mm	<b>8302.12</b>	1	Laparoscopy / 3
Handle, axial, mono	<b>83930084</b>	1	Laparoscopy / 14
Rotatable knob	<b>8988</b>	1	Laparoscopy / 14
Connection cable			
Mono HF connection cable L 3 m	<b>8106.033</b>	1	Laparoscopy / 13
Bipo HF connection cable L 3 m	<b>8108.132</b>	1	Laparoscopy / 13

## MINI FIBER TELESCOPES 2.0 MM

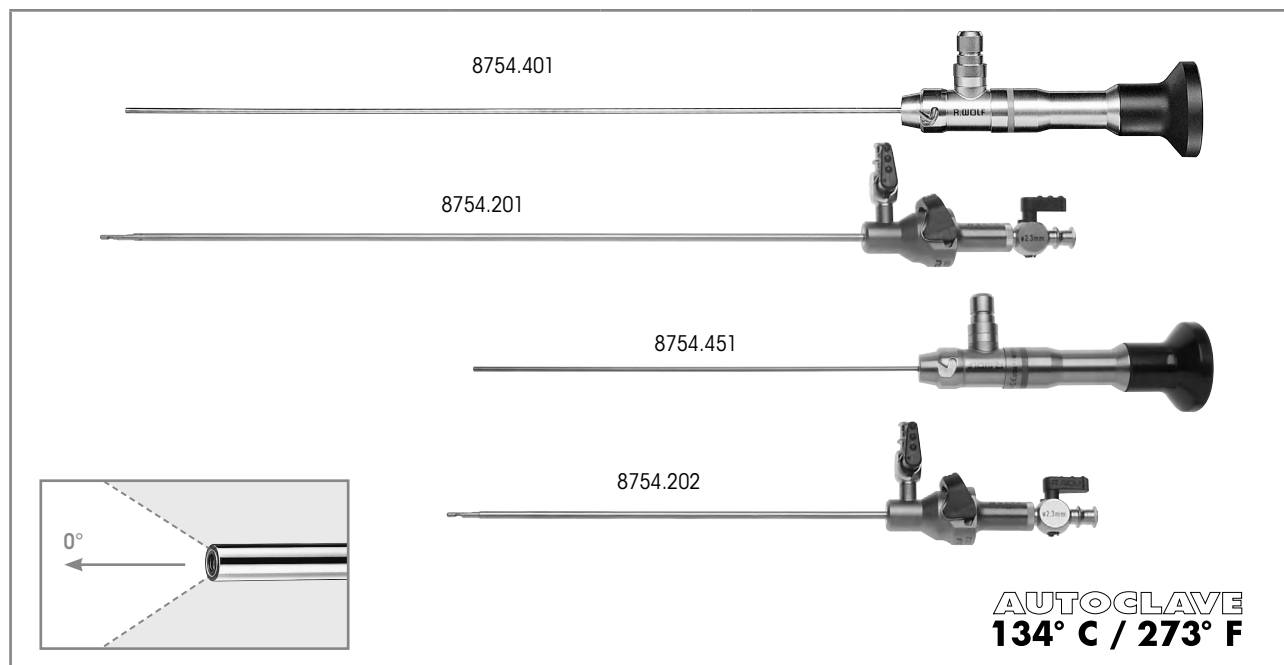

Long version	Direction of view	WL	TL	Ø	Product no.
Telescope 0° Ø 2 mm NL 268 mm	0°	268 mm	365 mm	2.0 mm	<b>8754.401</b>
<b>for this:</b>					
<b>VERES cannula Ø 2.3 mm WL 250 mm</b> consisting of: 1x VERES cannula Ø 2.3 mm WL 274 mm (8754.211) 1x outer sheath Ø 2.8 mm, WL 250 mm (8754.221)		250 mm		2.3 mm	<b>8754.201</b>
Short version	Direction of view	WL	TL	Ø	Product no.
Telescope 0° Ø 2 mm NL 158 mm	0°	158 mm	255 mm	2.0 mm	<b>8754.451</b>
<b>for this:</b>					
<b>VERES cannula Ø 2.3 mm WL 170 mm</b> consisting of: 1x VERES cannula Ø 2.3 mm WL 164 mm (8754.212) 1x outer sheath Ø 2.8 mm WL 141 mm (8754.222)		170 mm		2.3 mm	<b>8754.202</b>
Recommended accessories					Product no.
<b>Perforated basket for standard telescope 1</b> (for telescope 8754.451)		(W x H x D) 297 x 54 x 59 mm			<b>38015</b>
<b>Perforated basket for standard telescope 2</b> (for telescope 8754.401)		(W x H x D) 481 x 54 x 59 mm			<b>38016</b>
<b>Fiber light cable bndl</b> consisting of: Fiber light cable (80662523), projector-side adapter (8095.07), and endoscope-side adapter (809509)		Ø 2.5 mm, 2.3 m long			<b>806625231</b>

11123 || Subject to modifications. Please note that some products may not be available in all countries. Please always take note of the information that is provided with the product. For more detailed information, please consult with your contact partner or directly with Richard Wolf GmbH.

# LAPAROSCOPES 3.5 MM

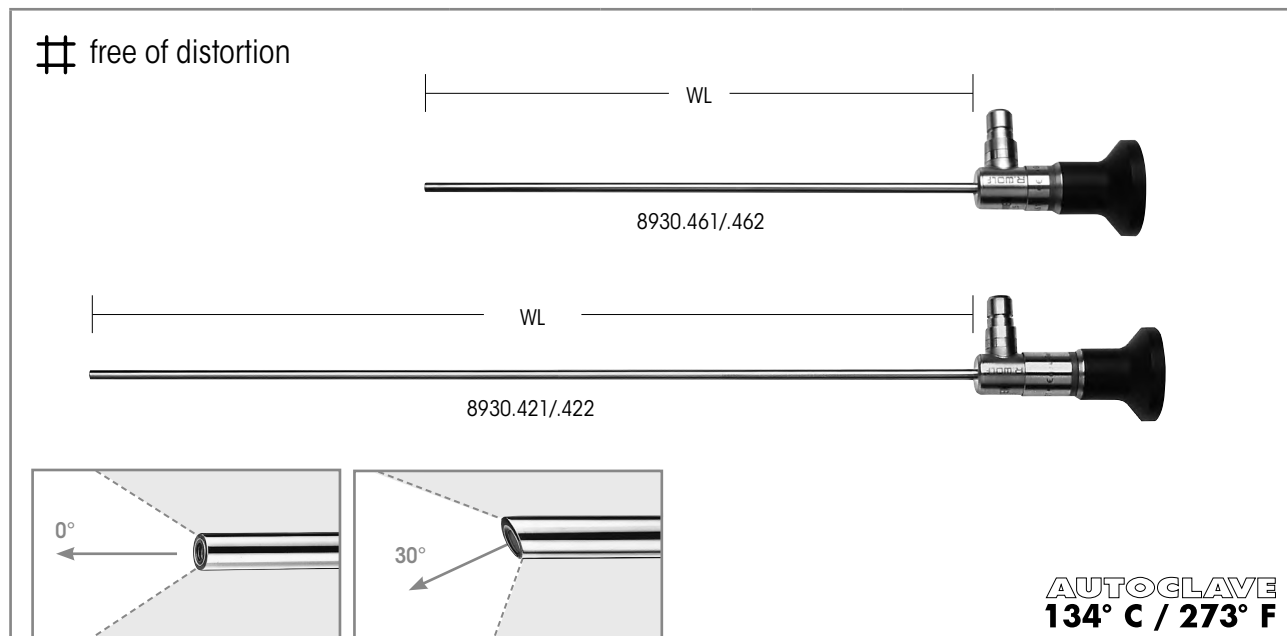

	Direction of view	WL	TL	Ø	Product no.
PANOVIEW PLUS Telescope 0° 3.5 mm WL 180 mm	0°	180 mm	232 mm	3.5 mm	<b>8930.461</b>
PANOVIEW PLUS Telescope 30° 3.5 mm WL 180 mm	30°		233 mm		<b>8930.462</b>
PANOVIEW PLUS Telescope 0° Ø 3.5 mm WL 300 mm	0°	300 mm	361 mm		<b>8930.421</b>
PANOVIEW PLUS Telescope 30° 3.5 mm WL 300 mm	30°		362 mm		<b>8930.422</b>

Recommended accessories		Product no.
<b>Perforated basket for standard telescope 1</b> (for telescope 8930.461/.462)	(W x H x D) 297 x 54 x 59 mm	<b>38015</b>
<b>Perforated basket for standard telescope 2</b> (for telescope 8930.421/.422)	(W x H x D) 481 x 54 x 59 mm	<b>38016</b>
<b>Fiber light cable bndl</b> consisting of: Fiber light cable (80662523), projector-side adapter (8095.07), and endoscope-side adapter (809509)	Ø 2.5 mm, 2.3 m long	<b>806625231</b>

|||23 || Subject to modifications. Please note that some products may not be available in all countries. Please always take note of the information that is provided with the product. For more detailed information, please consult with your contact partner or directly with Richard Wolf GmbH.



# LAPAROSCOPES 5.3 MM

# free of distortion

full screen

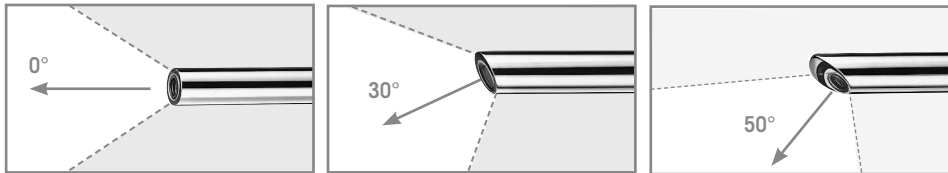
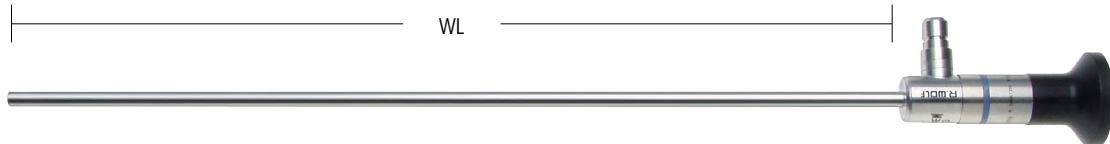

**AUTOCLAVE**  
**134° C / 273° F**

	Direction of view	WL	TL	Ø	Product no.
PANOVIEW Telescope 0° Ø 5.3 mm WL 303 mm	0°	303 mm	372 mm	5.3 mm	<b>8935.441</b>
PANOVIEW Telescope 30° Ø 5.3 mm WL 303 mm	30°		373 mm		<b>8935.442</b>
PANOVIEW Telescope 50° Ø 5.3 mm WL 309 mm	50°	309 mm	377 mm		<b>8935.443</b>

Recommended accessories		Product no.
<b>Perforated basket for standard telescope 2</b>	(W x H x D) 481 x 54 x 59 mm	<b>38016</b>
<b>Fiber light cable bndl</b> consisting of: Fiber light cable (80662523), projector-side adapter (8095.07), and endoscope-side adapter (809509)	Ø 2.5 mm, 2.3 m long	<b>806625231</b>

11123 || Subject to modifications. Please note that some products may not be available in all countries. Please always take note of the information that is provided with the product. For more detailed information, please consult with your contact partner or directly with Richard Wolf GmbH.

# MINI OR LAPAROSCOPE 5.5 MM WITH 3.5 MM WORKING CHANNEL

TELESCOPES

2

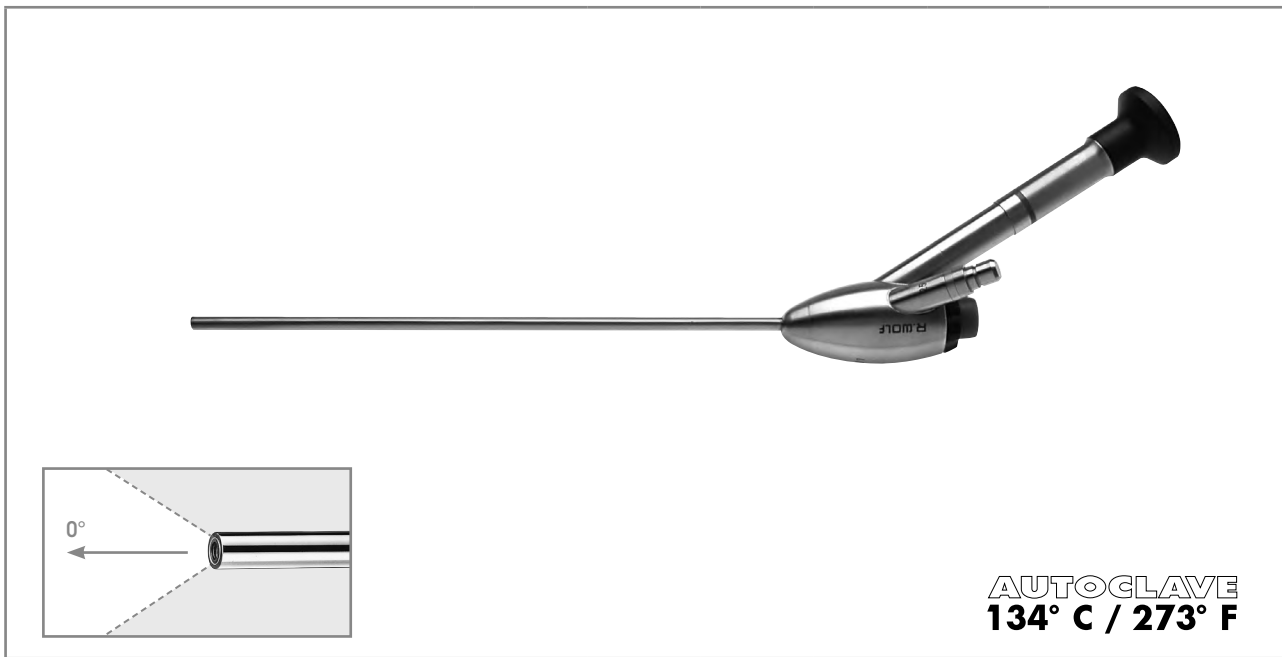

	Direction of view	SL	TL	Ø	Working channel Ø	Product no.
<b>OR endoscope bndl</b> consisting of: OR endoscope 0° Ø 5.5 mm SL 215 mm (8920.401) Autom. sealing element ID 5.7 mm (8920.311) Sealing cap, red-orange (15176.020) Sealing membrane Ø 17 mm (PACK= 10 PCS) (89.103)	0°	215 mm	370 mm	5.5 mm	3.5 mm	<b>8920.4011</b>

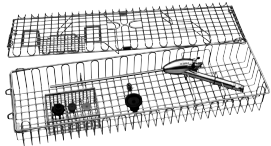
Recommended accessories		Product no.
Trocar sleeve, straight, capacity 5.5 mm WL 62 mm		<b>8919.333</b>
Trocar sleeve, straight, capacity 5.5 mm WL 102 mm		<b>8919.353</b>
<b>Perforated basket for telescope</b> Dimensions (W x L x H): 132 x 467 x 75 mm		<b>38008</b>
<b>Fiber light cable bndl</b> consisting of: Fiber light cable (80663523), projector-side adapter (8095.07), and endoscope-side adapter (809509)	Ø 3.5 mm, 2.3 m long	<b>806635231</b>

III23 || Subject to modifications. Please note that some products may not be available in all countries. Please always take note of the information that is provided with the product. For more detailed information, please consult with your contact partner or directly with Richard Wolf GmbH.

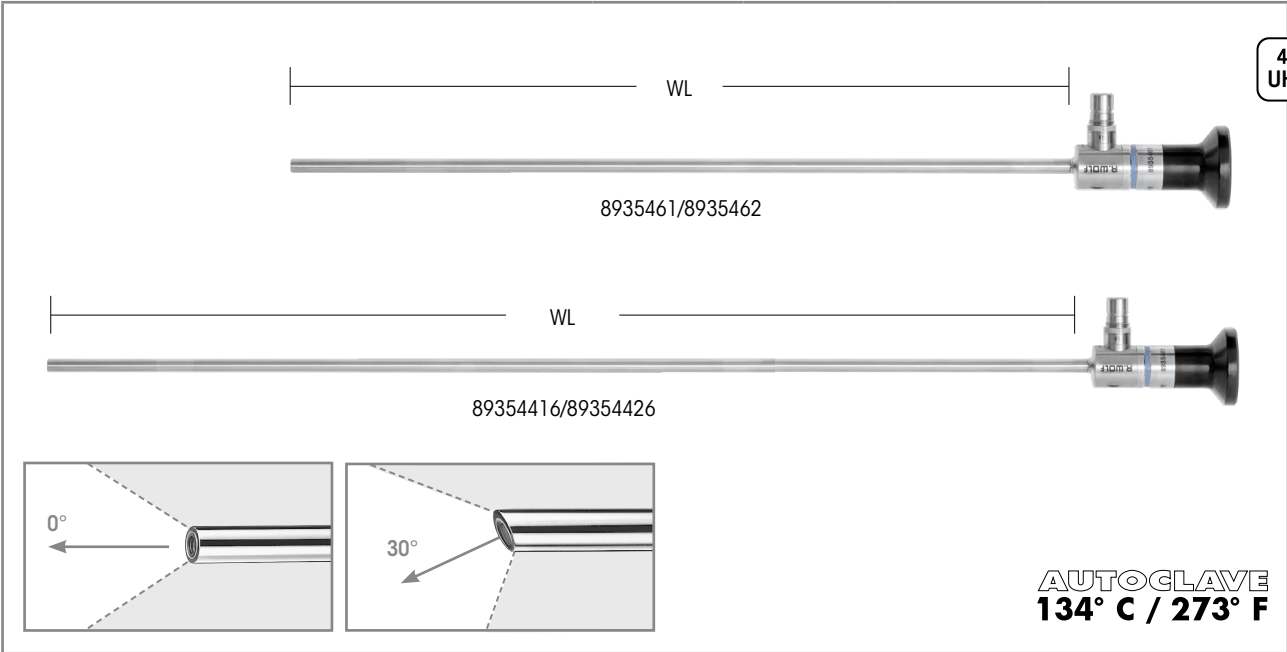

	Direction of view	WL	Ø	Product no.
PANOVIEW ULTRA Telescope Ø 5.5 mm WL 300 mm	0°	300 mm	5.5 mm	<b>8935461</b>
PANOVIEW ULTRA Telescope Ø 5.5 mm WL 300 mm	30°			<b>8935462</b>
PANOVIEW ULTRA Telescope Ø 5.5 mm WL 430 mm	0°	430 mm		<b>89354416</b>
PANOVIEW ULTRA Telescope Ø 5.5 mm WL 430 mm	30°			<b>89354426</b>

Recommended accessories		Product no.
<b>Perforated basket for standard telescope 2</b> (for telescope 8935416/8935426)	(W x H x D) 481 x 54 x 59 mm	<b>38016</b>
<b>Perforated basket for standard telescope 3</b> (for telescope 89354416/89354426)	(W x H x D) 619 x 54 x 59 mm	<b>38017</b>
<b>Fiber light cable bndl</b> consisting of: Fiber light cable (80663523), projector-side adapter (8095.07), and endoscope-side adapter (809509)	Ø 3.5 mm, 2.3 m long	<b>806635231</b>

11123 || Subject to modifications. Please note that some products may not be available in all countries. Please always take note of the information that is provided with the product. For more detailed information, please consult with your contact partner or directly with Richard Wolf GmbH.

# LAPAROSCOPES 10 MM

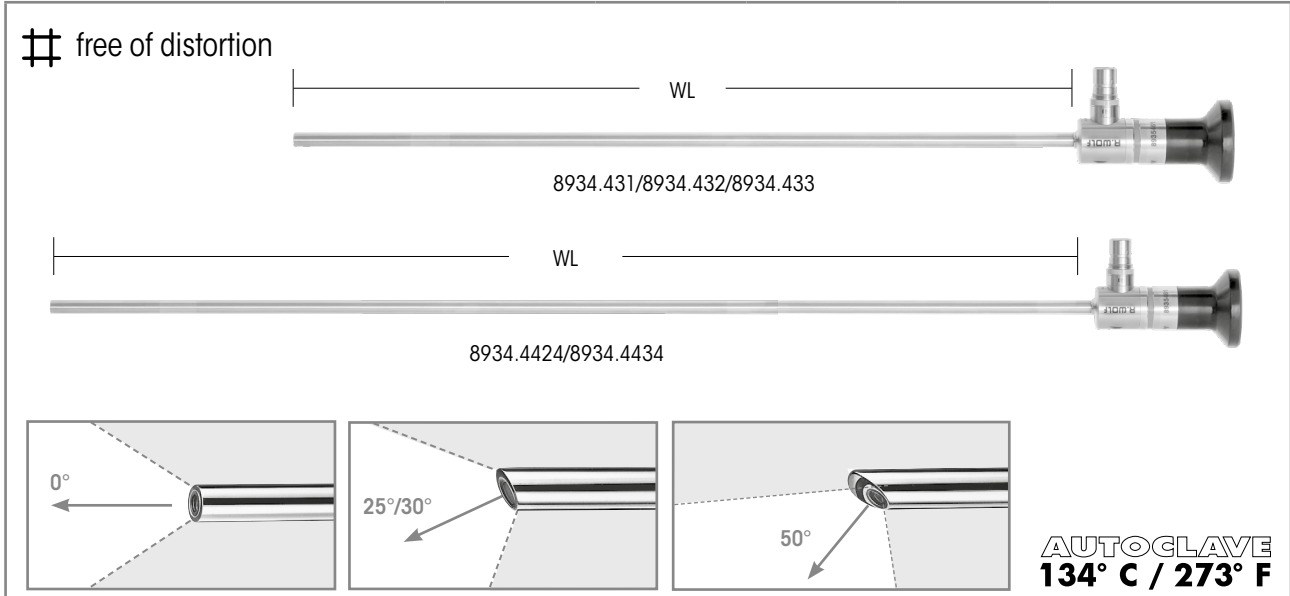

	Direction of view	WL	TL	Ø	Product no.
PANOVIEW Telescope 0° Ø 10 mm WL 307 mm	0°	307 mm	375 mm	10 mm	<b>8934.431</b>
PANOVIEW Telescope 30° Ø 10 mm WL 307 mm	30°	307 mm	375 mm		<b>8934.432</b>
PANOVIEW Telescope 50° Ø 10 mm WL 310 mm	50°	310 mm	378 mm		<b>8934.433</b>
PANOVIEW PLUS Telescope 25° Ø 10 mm WL 438 mm	25°	438 mm	507 mm		<b>8934.4424</b>
PANOVIEW PLUS Telescope 50° Ø 10 mm WL 447 mm	50°	447 mm	516 mm		<b>8934.4434</b>

Recommended accessories		Product no.
<b>Perforated basket for standard telescope 2</b> (for telescope 8934.431/.432/.433)	(W x H x D) 481 x 54 x 59 mm	<b>38016</b>
<b>Perforated basket for standard telescope 3</b> (for telescope 8934.4424/.4434)	(W x H x D) 619 x 54 x 59 mm	<b>38017</b>
<b>Fiber lightcable bndl</b> consisting of: Fiber light cable Ø 5 mm TL 2.3 m (80665023), projector-side adapter (8095.07), and endoscope-side adapter (809509)	Ø 5.0 mm, 2.3 m long	<b>806650231</b>
<b>Fusion Fiber light cable bndl</b> consisting of: Fiber light cable Ø 5 mm TL 2.3 m (80655023), projector-side adapter (8095.07), and endoscope-side adapter (809509)	Ø 5.0 mm, 2.3 m long	<b>806550231</b>

III23 || Subject to modifications. Please note that some products may not be available in all countries. Please always take note of the information that is provided with the product. For more detailed information, please consult with your contact partner or directly with Richard Wolf GmbH.

# 3D ENDOSCOPE 10 MM

11123 | Subject to modifications. Please note that some products may not be available in all countries. Please always take note of the information that is provided with the product. For more detailed information, please consult with your contact partner or directly with Richard Wolf GmbH.

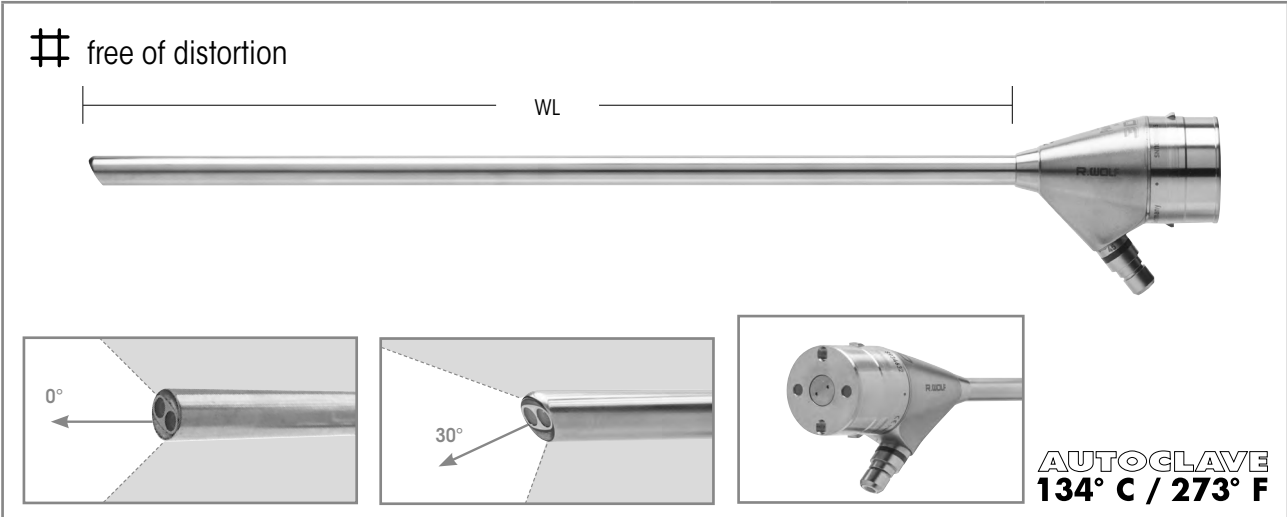

	Direction of view	WL	TL	Ø	Product no.
3D endoscope 0° Ø 10 mm WL 300 mm	0°	300 mm	366 mm	10 mm	8934631
3D endoscope 0° Ø 10 mm WL 435 mm		435 mm	500 mm		89344631
3D endoscope 30° Ø 10 mm WL 301 mm	30°	301 mm	366 mm		8934632
3D endoscope 30° Ø 10 mm WL 435 mm		435 mm	501 mm		89344632

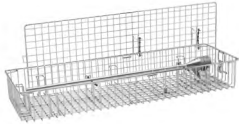
Recommended accessories		Product no.
<b>Perforated basket for 3D telescope</b> 	(W x H x D): 583 x 200 x 80 mm	<b>38014</b>
Fusion <b>Fiber light cable bndl</b> consisting of: Fiber light cable Ø 5 mm TL 2.3 m (80655023), projector-side, adapter (8095.07), and endoscope-side adapter (809509)	Ø 5.0 mm, 2.3 m long	<b>806550231</b>

# SURGICAL LAPAROSCOPE 10 MM

## FOR ONE HOLE APPENDECTOMY

TELESOPES

2

# free of distortion

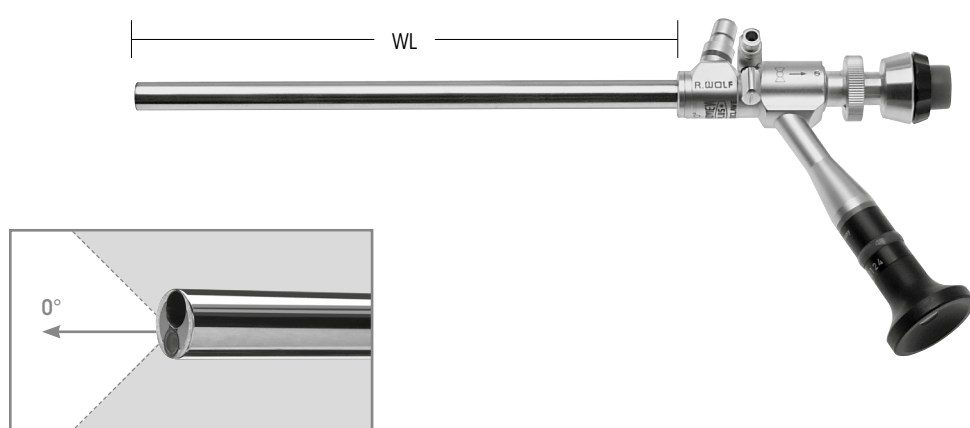

**AUTOCLAVE**  
**134° C / 273° F**

	Direction of view	WL	TL	Ø	Working channel Ø	Product no.
<b>PANOVIEW PLUS</b> <b>OR endoscope 0° Ø 10 mm WL 188 mm</b>  with lateral eyepiece	0°	188 mm	285 mm	10 mm	5.1 mm	<b>8915.501</b>

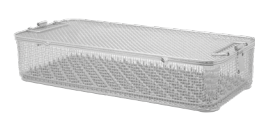
Recommended accessories		Product no.
<b>Universal perforated basket 4</b> (W x H x D): 538 x 117 x 250 mm		<b>33004</b>
for this: <b>Instrument mat for perforated basket</b>		<b>33001</b>
<b>Fiber light cable bndl</b> consisting of: Fiber light cable Ø 5 mm TL 2.3 m (80655023), projector-side adapter (8095.07), and endoscope-side adapter (809509)	Ø 5.0 mm, 2.3 m long	<b>806650231</b>
Fusion <b>Fiber light cable bndl</b> consisting of: Fiber light cable Ø 5 mm TL 2.3 m (80655023), projector-side adapter (8095.07), and endoscope-side adapter (809509)	Ø 5.0 mm, 2.3 m long	<b>806550231</b>

III23 | Subject to modifications. Please note that some products may not be available in all countries. Please always take note of the information that is provided with the product. For more detailed information, please consult with your contact partner or directly with Richard Wolf GmbH.



**AUTOCLAVE**  
**134° C / 273° F**



	Direction of view	WL	TL	Ø	Product no.
PANOVIEW ULTRA Telescope 0° Ø 10 mm WL 305 mm	0°	305 mm	375 mm	10 mm	8934461
PANOVIEW ULTRA Telescope 30° Ø 10 mm WL 305 mm	30°				8934462
PANOVIEW ULTRA Telescope 50° Ø 10 mm WL 305 mm	50°				8934463

4K  
UHD

ICG  
NIR

**Note:** Compatible with System green (see Imaging Catalog) (ICG/NIR-capable) and its recommended Fusion fiber light cable

Recommended accessories		Product no.
<b>Perforated basket for standard telescope 2</b>	(W x H x D) 481 x 54 x 59 mm	<b>38016</b>
<b>Fiber lightcable bndl</b> consisting of: Fiber light cable Ø 5 mm TL 2.3 m (80665023), projector-side adapter (8095.07), and endoscope-side adapter (809509)	Ø 5.0 mm, 2.3 m long	<b>806650231</b>
<b>Fusion fiber lightcable bndl</b> consisting of: Fiber light cable Ø 5 mm TL 2.3 m (80655023), projector-side adapter (8095.07), and endoscope-side adapter (809509)	Ø 5.0 mm, 2.3 m long	<b>806550231</b>

11123 || Subject to modifications. Please note that some products may not be available in all countries. Please always take note of the information that is provided with the product. For more detailed information, please consult with your contact partner or directly with Richard Wolf GmbH.



**AUTOCLAVE**  
**134° C / 273° F**

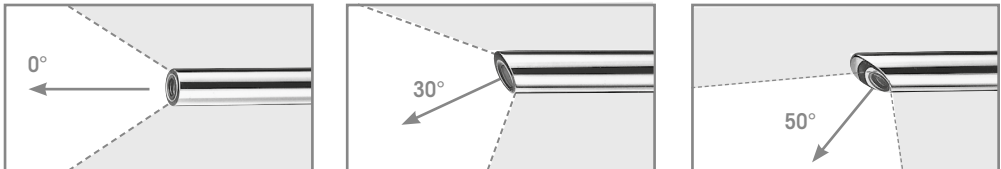

	Direction of view	WL	TL	Ø	Product no.
PANOVIEW ULTRA Telescope 0° Ø 10 mm WL 440 mm	0°	440 mm	510 mm	10 mm	<b>89344416</b>
PANOVIEW ULTRA Telescope 30° Ø 10 mm WL 440 mm	30°				<b>89344426</b>
PANOVIEW ULTRA Telescope 50° Ø 10 mm WL 440 mm	50°				<b>89344436</b>

**Note:** Compatible with System green (see Imaging Catalog) (ICG/NIR-capable) and its recommended Fusion fiber light cable

Recommended accessories		Product no.
<b>Perforated basket for standard telescope 3</b>	(W x H x D) 619 x 54 x 59 mm	<b>38017</b>
<b>Fiber lightcable bndl</b> consisting of: Fiber light cable Ø 5 mm TL 2.3 m (80665023), projector-side adapter (8095.07), and endoscope-side adapter (809509)	Ø 5.0 mm, 2.3 m long	<b>806650231</b>
Fusion <b>Fiber light cable bndl</b> consisting of: Fiber light cable Ø 5 mm TL 2.3 m (80655023), projector-side adapter (8095.07), and endoscope-side adapter (809509)	Ø 5.0 mm, 2.3 m long	<b>806550231</b>

III23 || Subject to modifications. Please note that some products may not be available in all countries. Please always take note of the information that is provided with the product. For more detailed information, please consult with your contact partner or directly with Richard Wolf GmbH.



**LIGHT TUBE FOR MILOS METHOD  
(MINI LESS OPEN SUBLAY METHOD)**



**AUTOCLAVE**  
**134° C / 273° F**



		Ø	TL	Product no.
	<p><b>Light tube for MILOS method Ø 10 mm</b> Instrument channel for 5 mm instruments</p>	10 mm	200 mm	<b>893420</b>

Recommended accessories		Product no.
<p><b>Fiber light cable bndl</b> consisting of: Fiber light cable Ø 5 mm, TL 2.3 m (80665023), projector-side adapter (8095.07), and endoscope-side adapter (809509)</p>	Ø 5.0 mm, 2.3 m long	<b>806650231</b>
<p>Fusion <b>Fiber light cable bndl</b> consisting of: Fiber light cable Ø 5 mm, TL 2.3 m (80655023), projector-side adapter (8095.07), and endoscope-side adapter (809509)</p>	Ø 5.0 mm, 2.3 m long	<b>806550231</b>
<p>Sealing cap, sulfur yellow, cap. 1.3 mm</p>		<b>8934201</b>



11123 || Subject to modifications. Please note that some products may not be available in all countries. Please always take note of the information that is provided with the product. For more detailed information, please consult with your contact partner or directly with Richard Wolf GmbH.



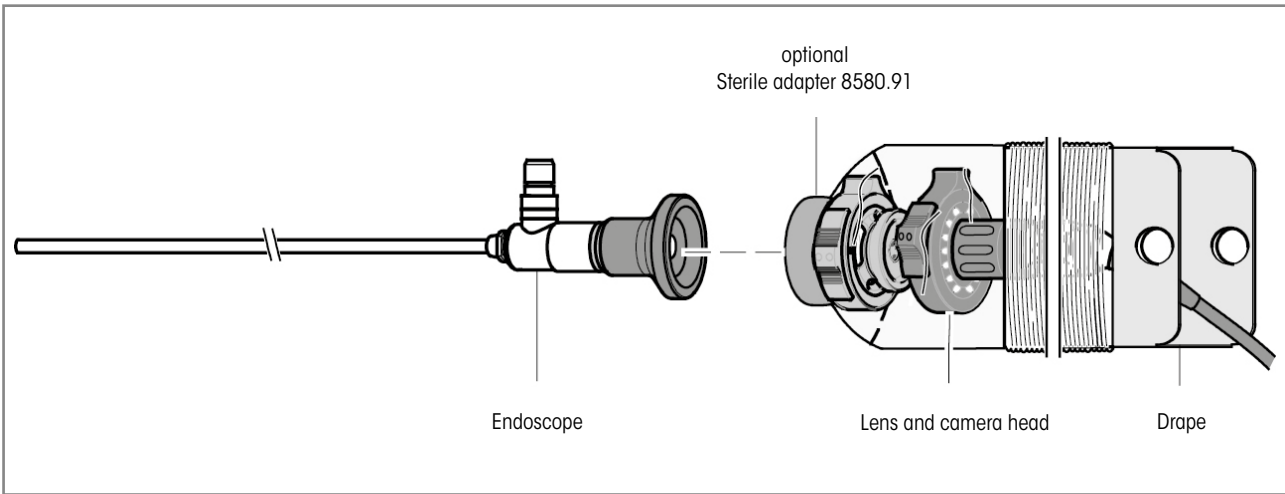

LAPAROSCOPES  
ACCESSORIES

			Product no.
	<b>Sterile adapter</b>	immersible and autoclavable for changing telescopes	<b>8580.91</b>



## TROCAR SLEEVES 2.2 / 2.5 MM



				Tip triangular	
				Trocar tip triangular Size 2.2 mm	
<b>Plastic sheath tube with thread</b>	<b>WL</b>	<b>Capacity</b>	<b>Product no.</b>	WL 82 mm	
<b>Trocar sleeve capacity 2.2 mm WL 60 mm with universal sealing valve</b>	 60 mm	2.2 mm	<b>8309.072</b>	<b>8309.121</b>	

Trocar sleeve with insufflation connector						Tip triangular	
Stainless steel sheath tube, smooth		<b>WL</b>	<b>Capacity</b>	<b>Product no.</b>	WL 82 mm		
<b>Trocar sleeve capacity 2.5 mm WL 95 mm</b>	 95 mm	2.5 mm	<b>8309.014</b>	<b>8309.121</b>			
				WL 119 mm			
<b>Trocar sleeve capacity 2.5 mm WL 95 mm</b>	 95 mm	2.5 mm	<b>8309.014</b>	<b>8309.123</b>			

<b>Accessories</b>	<b>Product no.</b>
<b>Rubber cap capacity 0.8 mm (PACK= 10 PCS) red</b>	<b>88.01</b>

# TROCAR SLEEVES 3.5 MM

## WITH INSUFFLATION STOPCOCK









<b>RIWO-ART trocar sleeves</b> with magnetic ball valve with insufflation stopcock						<b>Tip tapered/blunt</b> 	<b>Tip triangular</b> 
				<b>Trocar tip blunt</b> Size 3.5 mm	<b>Trocar tip triangular</b> Size 3.5 mm		
Stainless steel sheath tube, smooth		WL	Capacity	<b>Product no.</b>	WL 169 mm	WL 169 mm	
<b>Trocar sleeve straight</b> capacity 3.5 mm WL 100 mm		100 mm	3.5 mm	<b>8903.014</b>	<b>8903.103</b>	<b>8903.123</b>	
Plastic sheath tube with thread							
<b>Trocar sleeve straight</b> capacity 3.5 mm WL 100 mm		100 mm	3.5 mm	<b>8903.034</b>	<b>8903.103</b>	<b>8903.123</b>	
					WL 129 mm	WL 129 mm	
<b>Trocar sleeve slanted</b> capacity 3.5 mm WL 60 mm		60 mm	3.5 mm	<b>8903.072</b>	<b>8903.101</b>	<b>8903.121</b>	

Accessories	Product no.
Spare ball capacity 5.5 mm	<b>8921.901</b>
Spare O rings capacity 3.5 mm (PACK= 10 PCS), capacity Ø 3.5–5.5 mm	<b>8921.951</b>
Sealing cap capacity 2.4–3.4 mm (PACK= 10 PCS) red	<b>89.01</b>
Stopcock insert bndl cap. 3.0 mm (PACK= 5 PCS)	<b>896.0002</b>

<b>Trocar sleeve</b> with membrane valve						<b>Tip tapered/blunt</b> 
				<b>Trocar tip blunt</b> Size 3.5 mm		
Plastic sheath tube with distal screw anchor		WL	Capacity	<b>Product no.</b>	WL 169 mm	
<b>Trocar sleeve straight</b> capacity 3.5 mm WL 40 mm		40 mm	3.5 mm	<b>8929.223</b>	<b>8903.103</b>	

III23 || Subject to modifications. Please note that some products may not be available in all countries. Please always take note of the information that is provided with the product. For more detailed information, please consult with your contact partner or directly with Richard Wolf GmbH.









## TROCAR SLEEVES 5.5 MM

<b>RIWO-ART trocar sleeves</b> with magnetic ball valve with insufflation stopcock 				Tip tapered/blunt	Tip tapered/ pointed	Tip triangular
				Trocar tip blunt Size 5.5 mm	Trocar tip pointed Size 5.5 mm	Trocar tip triangular Size 5.5 mm
<b>Stainless steel sheath tube</b>	<b>WL</b>	<b>Capacity</b>	<b>Product no.</b>	<b>WL 169 mm</b>	<b>WL 169 mm</b>	<b>WL 169 mm</b>
<b>Trocar sleeve straight capacity 5.5 mm</b> WL 100 mm smooth 	100 mm	5.5 mm	<b>8921.014</b>	<b>8921.103</b>	<b>8921.113</b>	<b>8921.123</b>
<b>Trocar sleeve slanted capacity 5.5 mm</b> WL 100 mm smooth 	100 mm	5.5 mm	<b>8921.013</b>	<b>8921.103</b>	<b>8921.113</b>	<b>8921.123</b>
<b>Trocar sleeve straight capacity 5.5 mm</b> WL 100 mm with thread 	100 mm	5.5 mm	<b>8921.024</b>	<b>8921.103</b>	<b>8921.113</b>	<b>8921.123</b>
<b>Trocar sleeve slanted capacity 5.5 mm</b> WL 100 mm with thread 	100 mm	5.5 mm	<b>8921.023</b>	<b>8921.103</b>	<b>8921.113</b>	<b>8921.123</b>
Plastic tube <b>Trocar sleeve straight capacity 5.5 mm</b> WL 100 mm with thread 	100 mm	5.5 mm	<b>8921.034</b>	<b>8921.103</b>	<b>8921.113</b>	<b>8921.123</b>
				<b>WL 219 mm</b>	<b>WL 219 mm</b>	<b>WL 219 mm</b>
<b>Trocar sleeve straight capacity 5.5 mm</b> WL 150 mm smooth 	150 mm	5.5 mm	<b>8921.016</b>	<b>8921.105</b>	<b>8921.115</b>	<b>8921.125</b>
<b>Trocar sleeve straight capacity 5.5 mm</b> WL 150 mm with thread 	150 mm	5.5 mm	<b>8921.026</b>	<b>8921.105</b>	<b>8921.115</b>	<b>8921.125</b>

<b>Accessories</b>	<b>Product no.</b>
<b>Spare ball capacity 5.5 mm</b>	<b>8921.901</b>
<b>Spare O rings capacity 3.5 mm (PACK= 10 PCS), capacity Ø 3.5–5.5 mm</b>	<b>8921.951</b>
<b>Sealing cap capacity 3.4–5.1 mm (PACK= 10 PCS) blue</b>	<b>89.02</b>
<b>Stopcock insert bndl cap. 3.0 mm (PACK= 5 PCS)</b>	<b>896.0002</b>

1123 || Subject to modifications. Please note that some products may not be available in all countries. Please always take note of the information that is provided with the product. For more detailed information, please consult with your contact partner or directly with Richard Wolf GmbH.

# TROCAR SLEEVES 5.5 MM





RIWO-ART trocar sleeves with magnetic ball valve 				Tip tapered/blunt	Tip tapered/ pointed	Tip triangular	
				Trocar tip blunt Size 5.5 mm	Trocar tip pointed Size 5.5 mm	Trocar tip triangular Size 5.5 mm	
Stainless steel sheath tube		WL	Capacity	Product no.	WL 129 mm	WL 129 mm	WL 129 mm
Trocar sleeve straight capacity 5.5 mm WL 60 mm smooth 		60 mm	5.5 mm	8921.052	8921.101	8921.111	8921.121
Trocar sleeve slanted capacity 5.5 mm WL 60 mm smooth 		60 mm	5.5 mm	8921.051	8921.101	8921.111	8921.121
Trocar sleeve straight capacity 5.5 mm WL 60 mm with thread 		60 mm	5.5 mm	8921.062	8921.101	8921.111	8921.121
Trocar sleeve slanted capacity 5.5 mm WL 60 mm with thread 		60 mm	5.5 mm	8921.061	8921.101	8921.111	8921.121
Plastic tube Trocar sleeve straight capacity 5.5 mm WL 60 mm with thread 		60 mm	5.5 mm	8921.072	8921.101	8921.111	8921.121
					WL 169 mm	WL 169 mm	WL 169 mm
Trocar sleeve straight capacity 5.5 mm WL 100 mm smooth 		100 mm	5.5 mm	8921.054	8921.103	8921.113	8921.123
Trocar sleeve straight capacity 5.5 mm WL 100 mm with thread 		100 mm	5.5 mm	8921.053	8921.103	8921.113	8921.123

Accessories	Product no.
Spare ball capacity 5.5 mm	8921.901
Spare O rings capacity 3.5 mm (PACK= 10 PCS), capacity Ø 3.5–5.5 mm	8921.951
Sealing cap capacity 3.4–5.1 mm (PACK= 10 PCS) blue	89.02

# TROTEC

## TROCAR WITH AUTOMATIC PROTECTIVE FUNCTION

### FOR TROCAR SLEEVES 5.5 MM

Trocar consisting of:		Product no.	for RIWO-ART trocar sleeve with WL 100 mm, Ø 5,5 mm
Sheath with trocar tip Size 5.5 mm WL 181 mm	<b>Tapered tip</b> 	8921.132	
Sheath with trocar tip Size 5.5 mm WL 181 mm	<b>Two-sided tip</b> 	8921.134	
<b>Spring-loaded protective rod</b> WL 184 mm		8923.135	

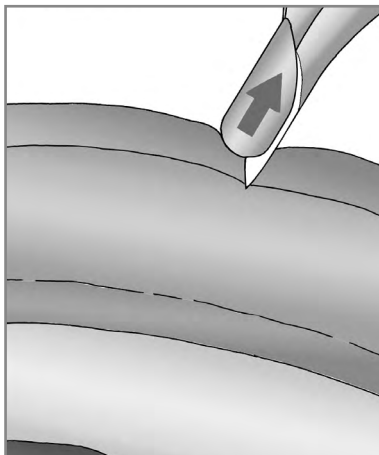

Protective tip automatically pushes back into the cannula through contact with the abdominal wall

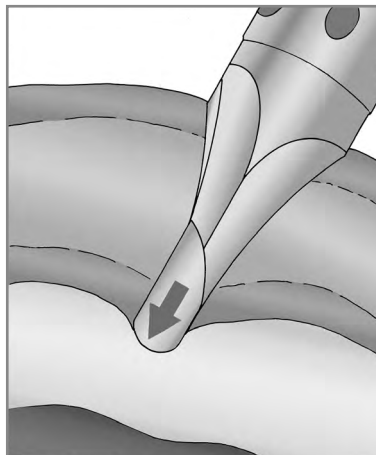

The protective tip advances into the free abdomen immediately after penetration of the peritoneum

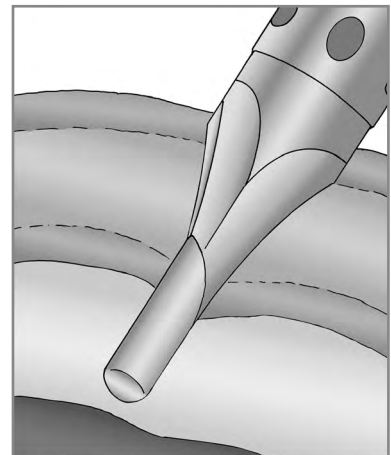





The atraumatic protective tip in a far distal position prevents perforation of organs and vessels

# TROCAR SLEEVE 5.5 MM/5.8 MM

PLASTIC WITH SEALING MEMBRANE

TROCAR SLEEVES

3

 <p><b>AUTOCLAVE</b> <b>134° C / 273° F</b></p>					Tip tapered/blunt	Tip tapered/pointed	Tip triangular
							
					Trocar tip blunt Size 5.5 mm	Trocar tip pointed Size 5.5 mm	Trocar tip triangular Size 5.5 mm
Flexible plastic sheath tube with thread	WL	Capacity	with stopcock	Product no.	WL 104 mm	WL 104 mm	WL 104 mm
Trocar sleeve straight capacity 5.5 mm WL 62 mm with membrane valve	62 mm	5.5 mm	●	8919.333	8919.3311	8919.3312	8919.3313
				8919.331			
					WL 144 mm	WL 144 mm	WL 144 mm
Trocar sleeve straight capacity 5.5 mm WL 102 mm with membrane valve	102 mm	5.5 mm	●	8919.353	8919.3511	8919.3512	8919.3513
				8919.351			

for curved instruments				Tip tapered/blunt	Tip tapered/pointed	Tip triangular	Tip tapered/blunt
 <p><b>AUTOCLAVE</b> <b>134° C / 273° F</b></p>							
				Trocar tip blunt Size 5.5 mm	Trocar tip pointed Size 5.5 mm	Trocar tip triangular Size 5.5 mm	Trocar tip blunt Size 5.5 mm
Flexible plastic sheath tube with thread	WL	Capacity	Product no.	WL 80 mm	WL 80 mm	WL 80 mm	WL 80 mm
Trocar sleeve straight capacity 5.8 mm WL 62 mm with membrane valve	62 mm	5.8 mm	8905.331	8905.3311	8905.3312	8905.3313	8905.3315
				WL 120 mm	WL 120 mm	WL 120 mm	WL 120 mm
Trocar sleeve straight capacity 5.8 mm WL 102 mm with membrane valve	102 mm	5.8 mm	8905.3515	8905.3511	8905.3512	8905.3513	8905.3515

Accessories	Product no.
Sealing membrane Ø 17 mm, yellow (PACK= 10 PCS)	89.103
Stopcock insert bndl cap 3.0 mm (PACK= 5 PCS)	896.0002

11123 || Subject to modifications. Please note that some products may not be available in all countries. Please always take note of the information that is provided with the product. For more detailed information, please consult with your contact partner or directly with Richard Wolf GmbH.



# TROCAR SLEEVE 5.7 MM/7 MM/10 MM/12.5 MM









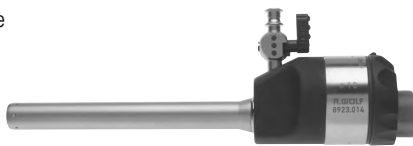

## FLEXIBLE PLASTIC SHEATH TUBE

				Tip tapered/blunt
				Trocar tip blunt
Flexible plastic sheath tube with thread	WL	Capacity	Product no.	Size 5.5 mm/WL 83 mm
Trocar sleeve straight capacity 5.7 mm WL 60 mm with rubber cap	60 mm	5.7 mm	8906.051	8906.151

				Tip tapered/blunt
				Trocar tip blunt
Ribbed flexible plastic sheath tube	WL	Capacity	Product no.	Size 7.3 mm/TL 108 mm
Trocar sleeve flexible capacity 7 mm WL 74 mm with universal seal	74 mm	7 mm	8906.001	8913.11
				Size 10 mm/TL 85 mm
Trocar sleeve flexible capacity 10 mm WL 56 mm with universal seal	56 mm	10 mm	8906.011	8906.111
				Size 12.5 mm/TL 86 mm
Trocar sleeve flexible capacity 12.5 mm WL 57 mm with universal seal	57 mm	12.5 mm	8906.031	8906.131

# TROCAR SLEEVE 10 MM

## WITH INSUFFLATION STOPCOCK





RIWO-ART trocar sleeves with magnetic ball valve 					Tip tapered/blunt	Tip tapered/pointed	Tip triangular
					 Trocar tip blunt Size 10 mm	 Trocar tip pointed Size 10 mm	 Trocar tip triangular Size 10 mm
Stainless steel sheath tube		WL	Capacity	Product no.	WL 164 mm	WL 164 mm	WL 164 mm
Trocar sleeve straight capacity 10 mm WL 100 mm 	100 mm	10 mm	<b>8923.014</b>	<b>8923.103</b>	<b>8923.113</b>	<b>8923.123</b>	
Trocar sleeve slanted capacity 10 mm WL 100 mm 	100 mm	10 mm	<b>8923.013</b>	<b>8923.103</b>	<b>8923.113</b>	<b>8923.123</b>	
Trocar sleeve straight capacity 10 mm WL 100 mm with thread 	100 mm	10 mm	<b>8923.024</b>	<b>8923.103</b>	<b>8923.113</b>	<b>8923.123</b>	
Trocar sleeve slanted capacity 10 mm WL 100 mm with thread 	100 mm	10 mm	<b>8923.023</b>	<b>8923.103</b>	<b>8923.113</b>	<b>8923.123</b>	
					WL 214 mm	WL 214 mm	WL 214 mm
Trocar sleeve straight capacity 10 mm WL 150 mm 	150 mm	10 mm	<b>8923.016</b>	-	<b>8923.115</b>	<b>8923.125</b>	
Trocar sleeve straight capacity 10 mm WL 150 mm with thread 	150 mm	10 mm	<b>8923.026</b>	-	<b>8923.115</b>	<b>8923.125</b>	

Accessories	Product no.
Spare ball capacity 7 mm	<b>8923901</b>
Spare O rings capacity 7 mm (PACK= 10 PCS), capacity Ø 7–12.5 mm	<b>8923951</b>
Sealing cap capacity 9.5–10.1 mm (PACK= 10 PCS) red	<b>8908</b>
Stopcock insert bndl cap. 3.0 mm (PACK= 5 PCS)	<b>896.0002</b>

# TROTEC

## TROCAR WITH AUTOMATIC PROTECTIVE FUNCTION

### FOR TROCAR SLEEVES 10 MM

Trocar consisting of:		Product no.	for RIWO-ART trocar sleeve with WL 100 mm, ø 10 mm
Sheath with trocar tip Size 10 mm WL 181 mm	<b>Tapered tip</b> 	<b>8923.132</b>	
Sheath with trocar tip Size 10 mm WL 181 mm	<b>Two-sided tip</b> 	<b>8923.134</b>	
<b>Spring-loaded protective rod</b> WL 184 mm		<b>8923.135</b>	

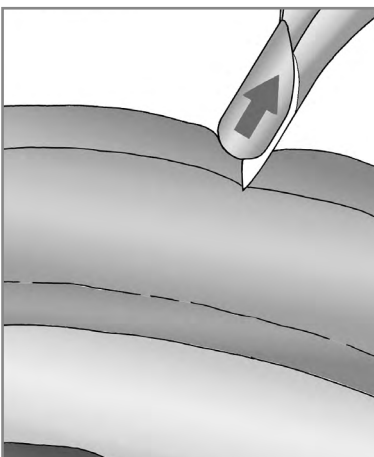

Protective tip automatically pushes back into the cannula through contact with the abdominal wall

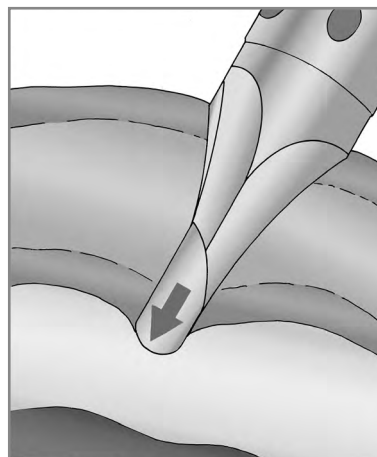

The protective tip advances into the free abdomen immediately after penetration of the peritoneum

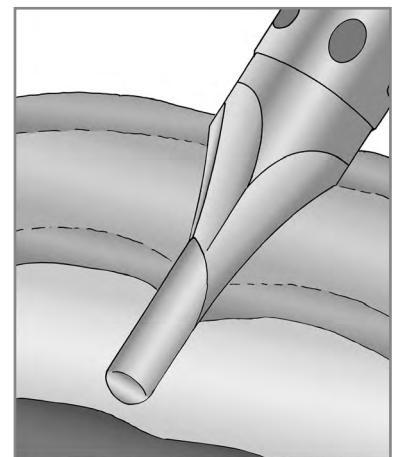

The atraumatic protective tip in a far distal position prevents perforation of organs and vessels



11123 | Subject to modifications. Please note that some products may not be available in all countries. Please always take note of the information that is provided with the product. For more detailed information, please consult with your contact partner or directly with Richard Wolf GmbH.

# HIGH FLOW TROCAR SLEEVE 10 MM

## WITH CONNECTOR FOR HIGH FLOW INSUFFLATION TUBE

TROCAR SLEEVES

3







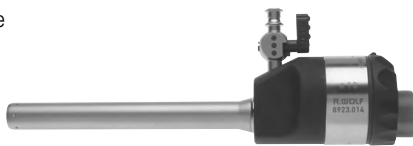

RIWO-ART trocar sleeves with magnetic ball valve 				Tip tapered/blunt	Tip tapered/pointed	Tip triangular		
								
				Trocar tip blunt Size 10 mm	Trocar tip pointed Size 10 mm	Trocar tip triangular Size 10 mm		
Stainless steel sheath tube		WL	Capacity	Product no.	WL 164 mm	WL 164 mm	WL 164 mm	
Trocar sleeve straight capacity 10 mm WL 100 mm			100 mm	10 mm	<b>8923.042</b>	<b>8923.103</b>	<b>8923.113</b>	<b>8923.123</b>
for this:						Product no.		
Reducing adapter (PACK= 5 PCS)			for reduction from Ø 7 mm, Ø 10 mm, and Ø 12.5 mm to Ø 5.5 mm			<b>8923802</b>		

Accessories	Product no.
Spare ball capacity 7 mm	<b>8923901</b>
Spare O rings capacity 7 mm (PACK= 10 PCS), capacity Ø 7–12.5 mm	<b>8923951</b>
Sealing cap capacity 9.5–10.1 mm (PACK= 10 PCS) red	<b>8908</b>

11123 || Subject to modifications. Please note that some products may not be available in all countries. Please always take note of the information that is provided with the product. For more detailed information, please consult with your contact partner or directly with Richard Wolf GmbH.

# TROCAR SLEEVE 12.5 MM

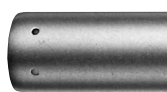
## WITH INSUFFLATION STOPCOCK





RIWO-ART trocar sleeves with magnetic ball valve 				Tip tapered/blunt	Tip tapered/pointed	Tip triangular
				 Trocar tip blunt Size 12.7 mm	 Trocar tip pointed Size 12.7 mm	 Trocar tip triangular Size 12.7 mm
<b>Stainless steel sheath tube</b>	WL	Capacity	Product no.	WL 164 mm	WL 164 mm	WL 164 mm
<b>Trocar sleeve straight</b> capacity 12.5 mm WL 100 mm 	100 mm	12.5 mm	<b>8924.014</b>	<b>8924.103</b>	<b>8924.113</b>	<b>8924.123</b>
<b>Trocar sleeve slanted</b> capacity 12.5 mm WL 100 mm 	100 mm	12.5 mm	<b>8924.013</b>	<b>8924.103</b>	<b>8924.113</b>	<b>8924.123</b>
				WL 214 mm	WL 214 mm	WL 214 mm
<b>Trocar sleeve straight</b> capacity 12.5 mm WL 150 mm with thread 	150 mm	12.5 mm	<b>8924.026</b>	-	<b>8924.115</b>	<b>8924.125</b>
<b>Trocar sleeve straight</b> capacity 12.5 mm WL 150 mm 	150 mm	12.5 mm	<b>8924.016</b>	-	<b>8924.115</b>	<b>8924.125</b>
for this:						
<b>Reducing adapter</b> (PACK= 5 PCS) 	for reduction from Ø 10 mm to Ø 5.5 mm and Ø 12.5 mm to Ø 5.5 mm				<b>8923.802</b>	
	for reduction from Ø 12.5 mm to Ø 10 mm				<b>8924.802</b>	

Accessories	Product no.
Spare ball capacity 7 mm	<b>8923.901</b>
Spare O rings capacity 7 mm (PACK= 10 PCS), capacity Ø 7–12.5 mm	<b>8923.951</b>
Sealing cap capacity 9.5–10.1 mm (PACK= 10 PCS) red	<b>89.08</b>
Stopcock insert bndl cap. 3.0 mm (PACK= 5 PCS)	<b>896.0002</b>

**TROTEC**  
**TROCAR WITH AUTOMATIC PROTECTIVE FUNCTION**  
 FOR TROCAR SLEEVES 12.5 MM

TROCAR SLEEVES

3

			
Trocar consisting of:		Product no.	for RIWO-ART trocar sleeve with WL 100 mm, Ø 12,5 mm
Sheath with trocar tip Size 12.5 mm WL 181 mm	Two-sided tip 	8924.134	
Spring-loaded protective rod WL 184 mm		8923.135	

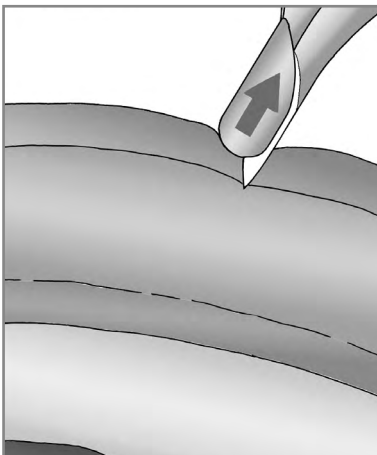

Protective tip automatically pushes back into the cannula through contact with the abdominal wall

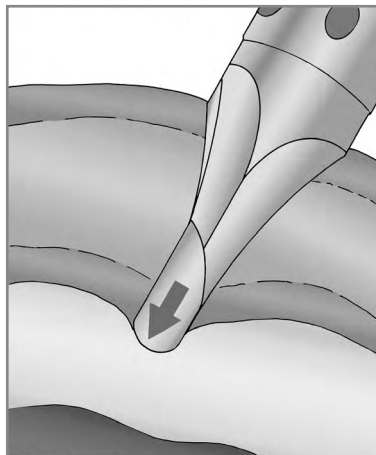

The protective tip advances into the free abdomen immediately after penetration of the peritoneum

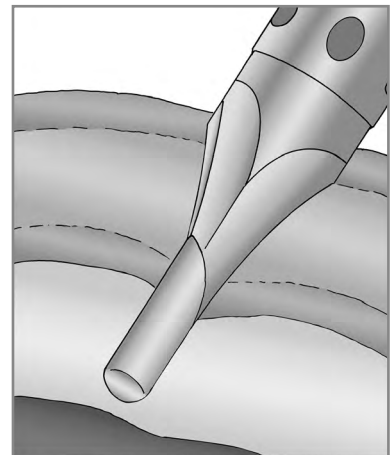

The atraumatic protective tip in a far distal position prevents perforation of organs and vessels

III23 || Subject to modifications. Please note that some products may not be available in all countries. Please always take note of the information that is provided with the product. For more detailed information, please consult with your contact partner or directly with Richard Wolf GmbH.

# DILATATION AND EXTRACTION INSTRUMENTS

5.5 TO 10/10 TO 12.5 MM

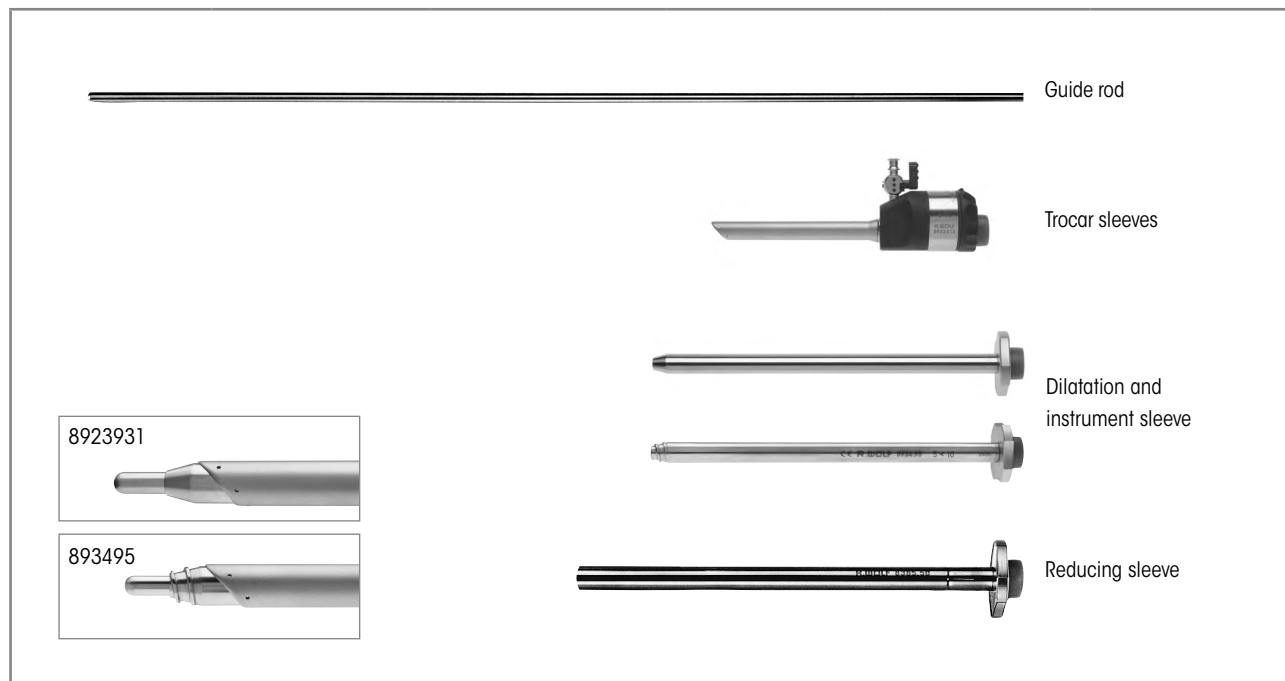

Incision widening	Guide rod	Trocar sleeve slanted	Dilatation sleeve	Instrument sleeve	Reducing sleeve
3.5 mm < 5.5 mm	-	<b>8921.013</b> capacity 5.5 mm WL 100 mm			<b>8383.78</b> Size 5 mm L 155 mm
5.5 mm < 10 mm	<b>8923.921</b> 5.5 mm TL 500 mm	<b>8923.013</b> capacity 10 mm WL 100 mm	<b>8923.931</b> Size 10 mm WL 170 mm	<b>8385.50</b> 10 mm WL 170 mm	
5.0 mm < 10 mm	<b>8934.951</b> 5 mm TL 500 mm		<b>8934.95</b> Size 10 mm WL 172 mm		
10 mm < 12.5 mm		<b>8924.013</b> capacity 12.5 mm WL 100 mm			<b>8941.901</b> 12 mm WL 180 mm
5.5 mm < 12.5 mm					<b>8941.951</b> 12 mm WL 180 mm
10 mm < 15 mm	<b>8943.901</b> 10 mm TL 500 mm				

11123 || Subject to modifications. Please note that some products may not be available in all countries. Please always take note of the information that is provided with the product. For more detailed information, please consult with your contact partner or directly with Richard Wolf GmbH.

## REDUCING SLEEVES FOR RIWO-ART TROCAR SLEEVES

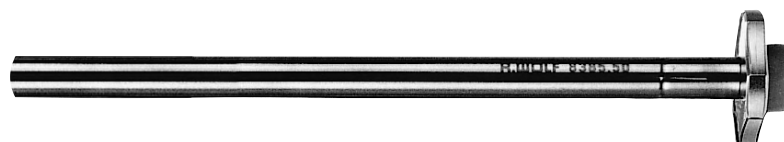



Stainless steel sheath tube	Outer Ø	WL	for instruments	Product no.
<b>Reducing sleeve</b> Size 5 mm WL 155 mm	5 mm	155 mm	3.5 mm	<b>8383.78</b>
<b>Instrument sleeve</b> 10 mm WL 170 mm	10 mm	170 mm	5.5 mm	<b>8385.50</b>
<b>Reducing sleeve</b> 12 mm WL 180 mm	12 mm	180 mm	10 mm	<b>8941.901</b>
<b>Reducing sleeve</b> 12 mm WL 180 mm	12 mm	180 mm	5.5 mm	<b>8941.951</b>
for this:				
<b>Reducing adapter</b> (PACK= 5 PCS)		for reduction from Ø 7 mm, Ø 10 mm, and Ø 12.5 mm to Ø 5.5 mm		<b>8923802</b>
		for reduction from Ø 12.5 mm to Ø 10 mm		<b>8924802</b>

Accessories	Product no.
<b>Sealing cap capacity 3.4–5.1 mm (PACK= 10 PCS) blue</b>	<b>89.02</b>
<b>Sealing cap capacity 9.5–10.1 mm (PACK= 10 PCS) red</b>	<b>8908</b>



# VERES CANNULAS

## FOR CREATION OF THE PNEUMOPERITONEUM

				
		Outer Ø	WL	Product no.
	VERES cannula Ø 2.1 mm WL 150 mm	2.1 mm	150 mm	8302.15
	VERES cannula Ø 2.1 mm WL 152 mm (standard length)		120 mm	8302.12
	VERES cannula Ø 2.1 mm WL 80 mm		80 mm	8302.08
<b>for this:</b>				
Tube with Luer-Lock connector				886.00

Accessories	Product no.
Stopcock insert bndl cap. 3.0 mm (PACK= 5 PCS)	896.0002

11123 || Subject to modifications. Please note that some products may not be available in all countries. Please always take note of the information that is provided with the product. For more detailed information, please consult with your contact partner or directly with Richard Wolf GmbH.

# ERAGON<sup>modular</sup>

## THE LAPAROSCOPIC TOOLBOX

### The toolbox principle

**ERAGONmodular** allows the surgeon to create their ideal laparoscopic set. Ergonomic handles, diameters relevant to all medical practice, useful working lengths, and a range of jaw sections can be combined as necessary. This universal compatibility also ensures that individual trays can comprise fewer instruments – for more efficiency and one way of cutting costs

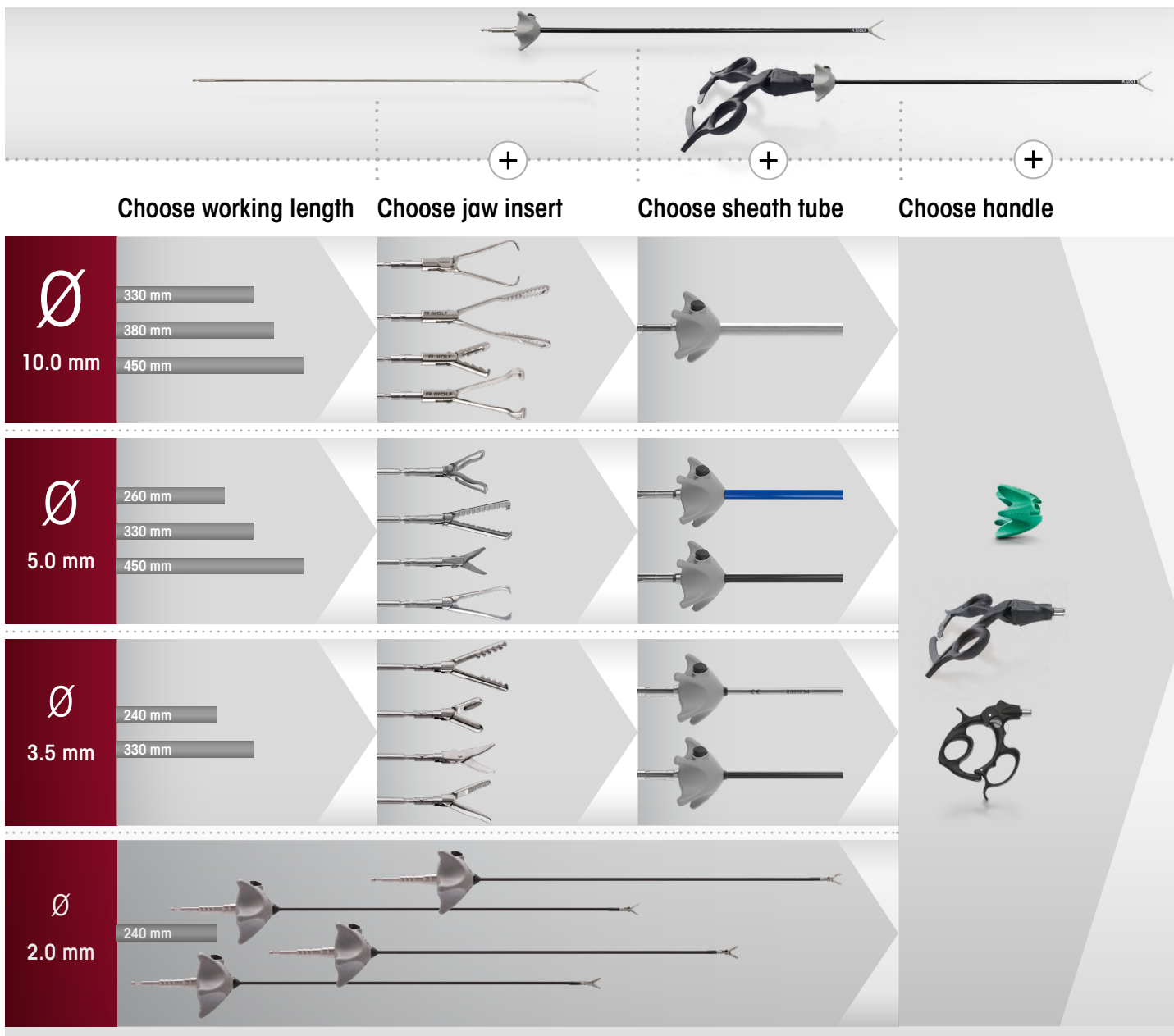

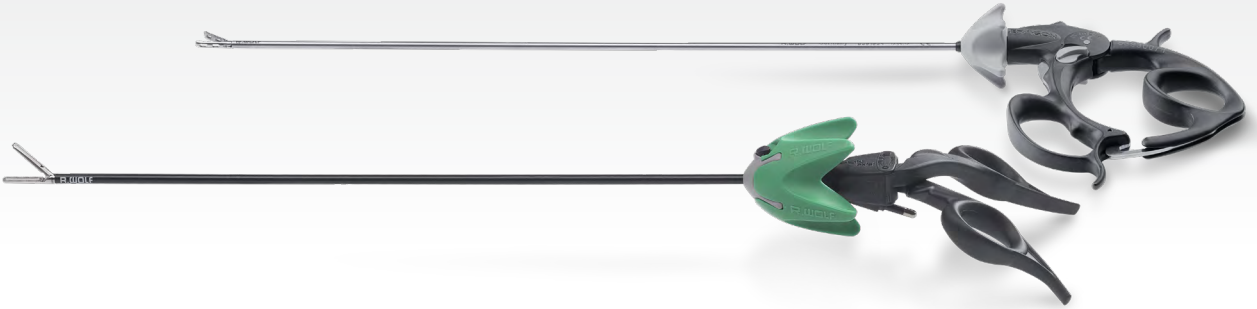

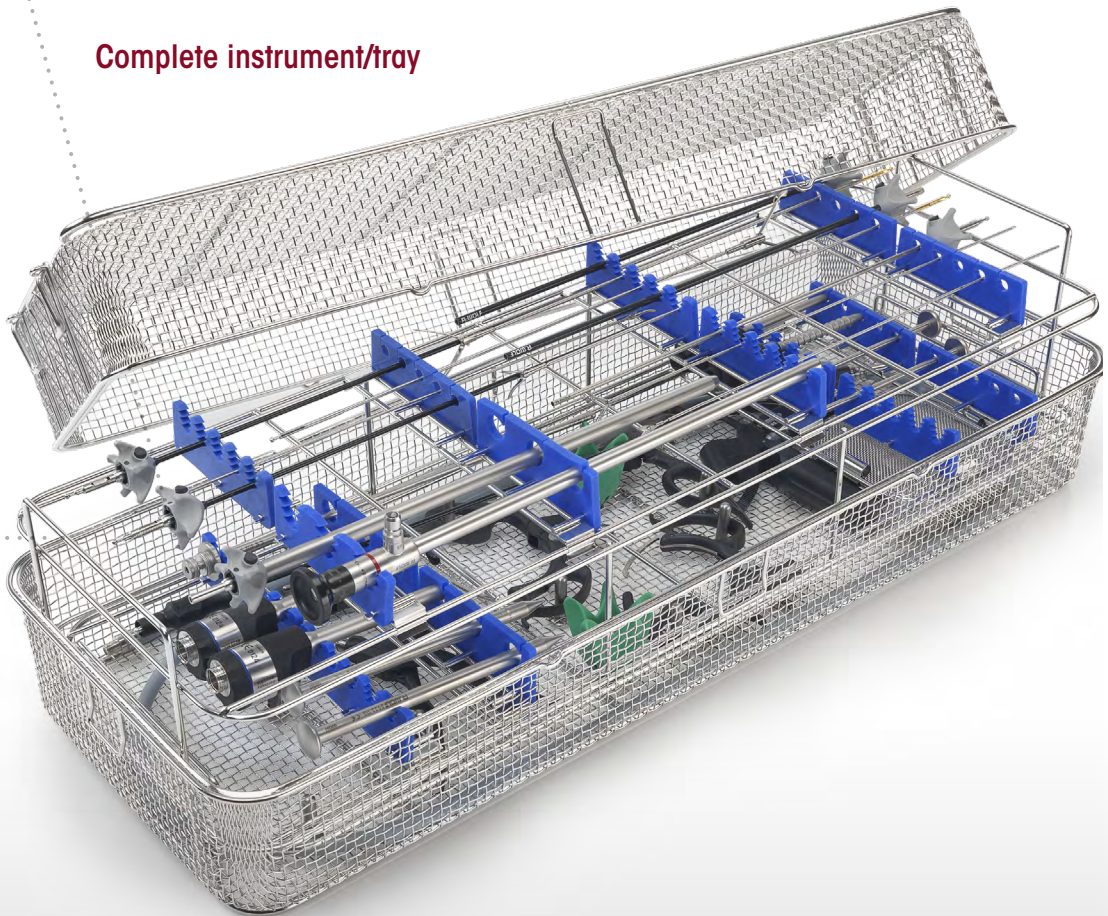

**Complete instrument/tray**









**ERAGON** modular  
micro  
Ø 2 MM, INSULATED

ERAGONMODULAR





4

		Handle, axial	
<b>ERAGON</b> axial			
All jaw inserts and sheath tubes can also be combined with <b>ERAGON</b> axial		without lock, with HF connector	without lock, with HF connector
<b>Rotatable knob</b>	<b>Product no.</b>	83930083	83930084
	8988	•	•

Jaw insert			Sheath tube, Ø 2.0 mm, insulated	Handle, pistol-shaped	Complete instrument • Jaw insert with sheath tube • Handle
					Product no.
			WL 240 mm	without lock, with HF, mono	
	<b>JL*</b>	<b>Product no.</b>		83930073	
 Scissors mono Ø 2 mm bndl straight, double-action	7 mm	8388200	•	•	<b>83882007</b>
 Dissector forceps mono Ø 2 mm bndl straight, double-action	7 mm	8388201	•	•	<b>83882017</b>
 Atraumatic grasping forceps mono Ø 2 mm bndl fenestrated, double-action	7 mm	8388202	•	•	<b>83882027</b>

\* JL = jaw length when jaw section closed (approximate measurements)  
HF connection cable: see sheet BDE116/117

**ERAGON** *modular*  
*micro*  
Ø 2 MM, INSULATED





Jaw insert		Sheath tube, Ø 2.0 mm, insulated		Handle, pistol-shaped	Complete instrument • Jaw insert with sheath tube • Handle
					
		WL 240 mm		with lock, with HF, mono	
	JL*	Product no.		83930074	Product no.
 Grasping forceps mono Ø 2 mm bndl  double-action	7 mm	8388203	•	•	<b>83882037</b>







\* JL = jaw length when jaw section closed (approximate measurements)  
HF connection cable: see sheet BDE116/117

Accessories for manual and machine reprocessing		Product no.
	Irrigation adapter Ø 9 mm, length 64 mm	<b>163502</b>

**ERAGON** modular mini

Ø 3.5 MM, INSULATED

		Handle, axial	
			
All jaw inserts and sheath tubes can also be combined with ERAGONaxial		without lock, with HF connector	without lock, with HF connector
<b>Rotatable knob</b>	<b>Product no.</b>	83930083	83930084
	8988	•	•









Jaw insert			Sheath tube, Ø 3.5 mm, insulated		Handle, pistol-shaped	Complete instrument
						<ul style="list-style-type: none"> <li>• Jaw insert with sheath tube</li> <li>• Handle</li> </ul>
			WL 240 mm	WL 330 mm	with lock, with HF, mono	
	JL*	<b>Product no.</b>	8390933	8391933	83930074	<b>Product no.</b>
	15 mm	8390207	•		•	<b>83902077</b>
curved to the left, double-action		8391207		•	•	<b>83912077</b>
	18 mm	8390221	•		•	<b>83902217</b>
long, fine tip, double-action		8391221		•	•	<b>83912217</b>
	14 mm	8390222	•		•	<b>83902227</b>
short, fine tip, double-action		8391222		•	•	<b>83912227</b>
	14 mm	8390223	•		•	<b>83902237</b>
angled, double-action		8391223		•	•	<b>83912237</b>

\* JL = jaw length when jaw section closed (approximate measurements)

HF connection cable: see sheet BDE116/117

**ERAGON** modular  
mini

Ø 3.5 MM, INSULATED

Jaw insert			Sheath tube, Ø 3.5 mm, insulated		Handle, pistol-shaped		Complete instrument • Jaw insert with sheath tube • Handle
							
							WL 240 mm
	JL*	Product no.	8390933	8391933	83930073	83930074	Product no.
 Metzenbaum scissors mono Ø 3.5 mm bndl 16 mm double-action		8390215	•		•		83902157
		8391215		•	•		83912157
 Metzenbaum scissors mono Ø 3.5 mm bndl 14 mm fine-toothed, curved, double-action		8390224	•		•		83902247
		8391224		•	•		83912247
 Hook scissors mono Ø 3.5 mm bndl 8 mm single-action		8390227	•		•		83902277
		8391227		•	•		83912277
 Double spoon forceps mono Ø 3.5 mm bndl 12 mm		8390216	•			•	83902167
		8391216		•		•	83912167
 Friedel punch mono Ø 3.5 mm bndl 10 mm		8390217	•			•	83902177
		8391217		•		•	83912177

\* JL = jaw length when jaw section closed (approximate measurements)





HF connection cable: see sheet BDE116/117







Accessories for manual and machine reprocessing		Product no.
	Irrigation adapter Ø 9 mm, length 64 mm	163502

**ERAGON** modular mini  
Ø 3.5 MM, UNINSULATED

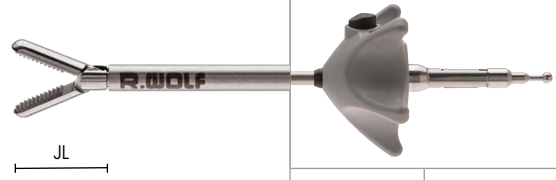
ERAGONMODULAR

4

		Handle, axial	
 All jaw inserts and sheath tubes can also be combined with ERAGONaxial			
		with lock, without HF connector	with lock, without HF connector, not rotatable
Rotatable knob	Product no.	83930082	83930085
	8988	.	







Jaw insert		Sheath tube, Ø 3.5 mm, uninsulated		Handle, pistol-shaped	Complete instrument • Jaw insert with sheath tube • Handle
		WL 240 mm	WL 330 mm		
	JL*	Product no.	8390933	8391933	83930072
	14 mm	8390208	.	.	83902087
fenestrated, double-action		8391208	.	.	83912087
	17 mm	8390218	.	.	83902187
fenestrated, single-action		8391218	.	.	83912187
	17 mm	8390225	.	.	83902257
double fenestrated, curved, single-action		8391225	.	.	83912257
	19 mm	8390226	.	.	83902267
fenestrated, double-action		8391226	.	.	83912267

\* JL = jaw length when jaw section closed (approximate measurements)  
HF connection cable: see sheet BDE116/117

III23 || Subject to modifications. Please note that some products may not be available in all countries. Please always take note of the information that is provided with the product. For more detailed information, please consult with your contact partner or directly with Richard Wolf GmbH.



**ERAGON modular mini**  
Ø 3.5 MM, UNINSULATED

Jaw insert			Sheath tube, Ø 3.5 mm, uninsulated		Handle, pistol-shaped	Complete instrument • Jaw insert with sheath tube • Handle
			WL 240 mm	WL 330 mm	 with lock, without HF	
			Product no.	8390933		8391933
 fenestrated, double-action	13 mm	8390219	•		•	83902197
		8391219		•	•	83912197
 fenestrated, single-action	17 mm	8390220	•		•	83902207
		8391220		•	•	83912207
 double-action	14 mm	8390209	•		•	83902097
		8391209		•	•	83912097
 double-action	19 mm	8390210	•		•	83902107
		8391210		•	•	83912107

\* JL = jaw length when jaw section closed (approximate measurements)







HF connection cable: see sheet BDE116/117







Accessories for manual and machine reprocessing		Product no.
	Irrigation adapter Ø 9 mm, length 64 mm	163503

**ERAGON** modular  
Ø 5.0 MM, INSULATED

ERAGONMODULAR

4

		Handle, axial			
 All jaw inserts and sheath tubes can also be combined with <b>ERAGONaxial</b>					
		with lock	without lock, with HF connector	without lock, with HF connector	with lock, not rotatable
Rotatable knob	Product no.	83930082	83930083	83930084	83930085
	8988	•	•	•	

Jaw insert		Sheath tube, Ø 5.0 mm, insulated		Handle, pistol-shaped	Complete instrument
					<ul style="list-style-type: none"> <li>• Jaw insert with sheath tube</li> <li>• Handle</li> </ul>
	JL*	SL 330 mm	SL 450 mm	with lock, with HF, mono	Product no.
	Product no.	8393933	8394933	83930074	
	21 mm	•	•	•	<b>83932817</b>
Maryland dissector forceps mono Ø 5 mm bndl curved, with fine cross toothing, double-action		8393.281			
		8394.281	•	•	<b>83942817</b>
	22 mm	•	•	•	<b>83932837</b>
Mixer dissector forceps mono Ø 5 mm bndl angled, fine, pyramid-shaped toothing, double-action		8393.283			
	21 mm	•	•	•	<b>83931857</b>
Grasping forceps, mono Ø 5 mm bndl fenestrated, with fine cross toothing, 15 mm long, single-action		8393.185			
	26 mm	•	•	•	<b>83931847</b>
Grasping forceps, mono Ø 5 mm bndl fenestrated, with fine cross toothing, 20 mm long, single-action		8393.184			
		8394.184	•	•	<b>83941847</b>







\* JL = jaw length when jaw section closed (approximate measurements)

HF connection cable: see sheet BDE116/117

III23 || Subject to modifications. Please note that some products may not be available in all countries. Please always take note of the information that is provided with the product. For more detailed information, please consult with your contact partner or directly with Richard Wolf GmbH.

**ERAGON** modular

Ø 5.0 MM, INSULATED

Jaw insert			Sheath tube, Ø 5.0 mm, insulated			Handle, pistol-shaped			Complete instrument • Jaw insert with sheath tube • Handle
			SL 260 mm	SL 330 mm	SL 450 mm	with lock, without HF	without lock, with HF, mono	with lock, with HF, mono	
	JL*	Product no.	8392933	8393933	8394933	83930072	83930073	83930074	Product no.
 <b>Dolphin dissector forceps mono Ø 5 mm bndl</b> angled, with fine cross-toothing, with channel, narrow, 15 mm long, double-action	17 mm	8393.285		•			•		<b>83932857</b>
 <b>Dissector forceps mono Ø 5 mm bndl</b> fine pyramid-shaped toothing, narrow, 18 mm, double-action	23 mm	8393.289		•				•	<b>83932897</b>
 <b>Atraumatic grasping forceps Ø 5 mm bndl</b> Channel with wavy tooth edge, 20 mm, single-action	26 mm	8393.292		•			•		<b>83932925</b>
 <b>Atraumatic grasping forceps Ø 5 mm bndl</b> Channel with wavy tooth edge, 20 mm, double-action	26 mm	8393.293		•			•		<b>83932935</b>
		8394.293			•		•		<b>83942935</b>
 <b>Grasping forceps, mono Ø 5 mm bndl</b> fine, pyramid-shaped toothing, narrow double-action	19 mm	8393.288		•				•	<b>83932887</b>
 <b>Atraumatic grasping forceps mono Ø 5 mm bndl</b> fenestrated, with cross toothing, double-action	19 mm	8392.181	•					•	<b>83921817</b>
		8393.181		•				•	<b>83931817</b>
		8394.181			•			•	<b>83941817</b>

\* JL = jaw length when jaw section closed (approximate measurements)







HF connection cable: see sheet BDE116/117



11123 || Subject to modifications. Please note that some products may not be available in all countries. Please always take note of the information that is provided with the product. For more detailed information, please consult with your contact partner or directly with Richard Wolf GmbH.

**ERAGON** modular  
Ø 5.0 MM, INSULATED

ERAGONMODULAR

4

		Handle, axial			
 All jaw inserts and sheath tubes can also be combined with <b>ERAGONaxial</b>					
		with lock	without lock, with HF connector	without lock, with HF connector	with lock, not rotatable
<b>Rotatable knob</b>	<b>Product no.</b>	83930082	83930083	83930084	83930085
	8988	•	•	•	

Jaw insert		Sheath tube, Ø 5.0 mm, insulated		Handle, pistol-shaped		Complete instrument • Jaw insert with sheath tube • Handle
						
	JL*	SL 330 mm	SL 450 mm	with lock, without HF	without lock, with HF, mono	<b>Product no.</b>
<b>Atraumatic grasping forceps mono Ø 5 mm bndl</b>	18 mm	8393.195				<b>83931957</b>
smooth, double-action		8394.195				<b>83941957</b>
<b>Babcock forceps Ø 5 mm bndl</b>	24 mm	8393.186				<b>83931867</b>
Gripping surface with fine cross tothing, double-action						
<b>Babcock forceps Ø 5 mm bndl</b>	26 mm	8393.187				<b>83931877</b>
large distal gripping surface with fine cross tothing, double-action		8394.187				<b>83941877</b>
<b>Debakey forceps Ø 5 mm bndl</b>	39 mm	8393190				<b>83931907</b>
atraumatic clamp, double-action						









\* JL = jaw length when jaw section closed (approximate measurements)

HF connection cable: see sheet BDE50 1710

III23 || Subject to modifications. Please note that some products may not be available in all countries. Please always take note of the information that is provided with the product. For more detailed information, please consult with your contact partner or directly with Richard Wolf GmbH.

**ERAGON** modular







Ø 5.0 MM, INSULATED









Jaw insert			Sheath tube, Ø 5.0 mm, insulated		Handle, pistol-shaped		Complete instrument • Jaw insert with sheath tube • Handle
							
			SL 330 mm	SL 450 mm	with lock, without HF	with lock, with HF, mono	
	JL*	Product no.	8393933	8394933	83930072	83930074	Product no.
 <b>Debaque forceps</b> Ø 5 mm bndl atraumatic clamp, double-action	48 mm	8393191	•		•		<b>83931917</b>
 <b>Grasping forceps, mono</b> Ø 5 mm bndl with a row of teeth, double-action	17 mm	8393.485	•			•	<b>83934857</b>
 <b>Grasping forceps, mono</b> Ø 5 mm bndl with one tooth, fine cross toothing, narrow, double-action	19 mm	8393.486	•			•	<b>83934867</b>
 <b>Grasping forceps, mono</b> Ø 5 mm bndl with two teeth, fine cross toothing, single-action	17 mm	8393.487	•			•	<b>83934877</b>
 <b>Grasping forceps</b> Ø 5 mm bndl with two teeth wavy gripping surface, double-action		8393.490	•		•		<b>83934907</b>
		8394.490		•	•		<b>83944907</b>
 <b>Petelin dissector forceps</b> mono Ø 5 mm bndl angled 30° to the left, with cross toothing, single-action	17 mm	8393.282	•			•	<b>83932827</b>

\* JL = jaw length when jaw section closed (approximate measurements)

HF connection cable: see sheet BDE116/117

**ERAGON** modular  
Ø 5.0 MM, INSULATED

		Handle, axial			
 All jaw inserts and sheath tubes can also be combined with ERAGONaxial					
		with lock	without lock, with HF connector	without lock, with HF connector	with lock, not rotatable
<b>Rotatable knob</b>	<b>Product no.</b>	83930082	83930083	83930084	83930085
	8988	•	•	•	







Jaw insert		Sheath tube, Ø 5.0 mm, insulated	Handle, pistol-shaped			Complete instrument	
		 SL 330 mm				• Jaw insert with sheath tube • Handle	
	JL*	<b>Product no.</b>	8393933	83930072	83930073	83930074	<b>Product no.</b>
 <b>Plate-shaped grasping forceps mono Ø 5 mm bndl</b> fenestrated with fine cross tothing, double-action	18 mm	8393.182	•			•	<b>83931827</b>
 <b>Grasping forceps mono Ø 5 mm bndl</b> with cross tothing, double-action	21 mm	8393.183	•		•		<b>83931837</b>
 <b>Grasping forceps mono Ø 5 mm bndl</b> distal cross tothing with channel, double-action	15 mm	8393.287	•		•		<b>83932877</b>
 <b>Claw grasping forceps Ø 5 mm bndl</b> double-action	27 mm	8393.494	•	•			<b>83934945</b>

\* JL = jaw length when jaw section closed (approximate measurements)

HF connection cable: see sheet BDE116/117

**ERAGON** modular

Ø 5.0 MM, INSULATED

Jaw insert			Sheath tube, Ø 5.0 mm, insulated		Handle, pistol-shaped			Complete instrument • Jaw insert with sheath tube • Handle
			SL 330 mm	SL 450 mm	with lock, without HF	without lock, with HF, mono	with lock, with HF, mono	
	JL*	Product no.	8393933	8394933	83930072	83930073	83930074	Product no.
<b>Myoma grasping forceps</b> Ø 5 mm bndl  2x3-claw, single-action	29 mm	8393.488	•		•			<b>83934887</b>
<b>Universal grasping forceps</b> mono Ø 5 mm bndl  with pyramid-shaped toothing and cross toothing, double-action	18 mm	8393.481	•				•	<b>83934817</b>
<b>Universal grasping forceps</b> Ø 5 mm bndl  pyramid-shaped toothing and cross toothing, double-action	26 mm	8393.482	•		•			<b>83934827</b>
<b>Grasping forceps</b> mono Ø 5 mm bndl  Pike-mouth, double-action	20 mm	8393.483	•				•	<b>83934837</b>
<b>Biopsy forceps</b> mono Ø 5 mm bndl  with spikes, double-action	13 mm	8393.091	•				•	<b>83930917</b>
		8394.091		•		•		<b>83940917</b>
<b>Biopsy forceps</b> mono Ø 5 mm bndl  severing, single-action	14 mm	8393.092	•				•	<b>83930927</b>
		8394.092		•		•		<b>83940927</b>







\* JL = jaw length when jaw section closed (approximate measurements)









HF connection cable: see sheet BDE116/117

**ERAGON** modular  
Ø 5.0 MM, INSULATED

ERAGONMODULAR

4

		Handle, axial			
 All jaw inserts and sheath tubes can also be combined with ERAGONaxial					
		with lock	without lock, with HF connector	without lock, with HF connector	with lock, not rotatable
<b>Rotatable knob</b>	<b>Product no.</b>	83930082	83930083	83930084	83930085
	8988	•	•	•	







Jaw insert			Sheath tube, Ø 5.0 mm, insulated		Handle, pistol-shaped		Complete instrument • Jaw insert with sheath tube • Handle
							
	JL*	<b>Product no.</b>	SL 330 mm	SL 450 mm	with lock, without HF	without lock, with HF, mono	<b>Product no.</b>
 <b>Biopsy forceps mono Ø 5 mm bndl</b> pointed spoon forceps, single-action	20 mm	8393.093	•			•	<b>83930937</b>
 <b>Knot pusher Ø 5 mm bndl</b> with distal recess, double-action	17 mm	8393.345	•		•		<b>83933457</b>
		8394.345		•			<b>83943457</b>
 <b>Grasping forceps Ø 5 mm bndl</b> spring jaw sections fenestrated with cross toothing, double-action	37 mm	8393.188	•		•		<b>83931887</b>
 <b>Grasping forceps Ø 5 mm bndl</b> spring jaw sections fenestrated with cross toothing, double-action	47 mm	8393.189	•		•		<b>83931897</b>
		8394.189		•			<b>83941897</b>

\* JL = jaw length when jaw section closed (approximate measurements)  
HF connection cable: see sheet BDE116/117

III23 || Subject to modifications. Please note that some products may not be available in all countries. Please always take note of the information that is provided with the product. For more detailed information, please consult with your contact partner or directly with Richard Wolf GmbH.



**ERAGON** modular  
Ø 5.0 MM, INSULATED

Jaw insert			Sheath tube, Ø 5.0 mm, insulated		Handle, pistol-shaped		Complete instrument • Jaw insert with sheath tube • Handle
			SL 330 mm	SL450 mm	with lock, without HF	with lock, with HF, mono	
	JL*	Product no.	8393933	8394933	83930072	83930074	Product no.
 <b>Debaquey forceps</b> Ø 5 mm bndl atraumatic, spring jaw sections with cross toothing, double-action	47 mm	8393.291	•		•		<b>83932917</b>
 <b>Dissector forceps mono</b> Ø 5 mm bndl angled, double-action	18 mm	8393192	•			•	<b>83931927</b>
		8394192		•		•	<b>83941927</b>
 <b>Grasping forceps, mono</b> Ø 5 mm bndl double-action	16 mm	8393193	•		•		<b>83931937</b>
		8394193		•	•		<b>83941937</b>
 <b>Dissector forceps mono</b> Ø 5 mm bndl double-action	24 mm	8393194	•			•	<b>83931947</b>
		8394194		•		•	<b>83941947</b>
 <b>Dissector forceps mono</b> Ø 5 mm bndl double-action	30 mm	8393197	•			•	<b>83931977</b>
		8394197		•		•	<b>83941977</b>
 <b>Dissector forceps mono</b> Ø 5 mm bndl fine tips double-action	33 mm	8393198	•			•	<b>83931987</b>
		8394198		•		•	<b>83941987</b>







\* JL = jaw length when jaw section closed (approximate measurements)







HF connection cable: see sheet BDE116/117

**ERAGON** modular  
Ø 5.0 MM, INSULATED

ERAGONMODULAR

4

		Handle, axial			
 All jaw inserts and sheath tubes can also be combined with ERAGONaxial					
		with lock	without lock, with HF connector	without lock, with HF connector	with lock, not rotatable
Rotatable knob	Product no.	83930082	83930083	83930084	83930085
	8988	•	•	•	









Jaw insert		Sheath tube, Ø 5.0 mm, insulated		Handle, pistol-shaped	Complete instrument
					<ul style="list-style-type: none"> <li>• Jaw insert with sheath tube</li> <li>• Handle</li> </ul>
	JL*	SL 330 mm	SL 450 mm	with lock, with HF, mono	Product no.
	32 mm	8393199	8394199	83930074	83931997
Dissector forceps mono Ø 5 mm bndl		•	•	•	83941997
double-action					
	19 mm	8393200	8394200		83932007
Dissector forceps mono Ø 5 mm bndl		•	•	•	83942007
fine tip, double-action					
	16 mm	8393210			83932107
Atraumatic grasping forceps mono Ø 5 mm bndl		•		•	
atraumatic, with cross toothing, double-action					
	19mm	8393220			83932207
Atraumatic grasping forceps mono Ø 5 mm bndl		•		•	83942207
atraumatic, with cross toothing, double-action				•	

\* JL = jaw length when jaw section closed (approximate measurements)  
 HF connection cable: see sheet BDE116/117

11123 || Subject to modifications. Please note that some products may not be available in all countries. Please always take note of the information that is provided with the product. For more detailed information, please consult with your contact partner or directly with Richard Wolf GmbH.

**ERAGON** modular

Ø 5.0 MM, INSULATED

Jaw insert			Sheath tube, Ø 5.0 mm, insulated		Handle, pistol-shaped		Complete instrument • Jaw insert with sheath tube • Handle
							
			SL 330 mm	SL 450 mm	with lock, without HF	with lock, with HF, mono	
	JL*	Product no.:	8393933	8394933	83930072	83930074	Product no.:
 <b>Atraumatic grasping forceps Ø 5 mm bndl</b> atraumatic, with pyramid-shaped toothings and cross toothings, double-action	29 mm	8393223	•		•		<b>83932237</b>
		8394223		•	•		<b>83942237</b>
 <b>Atraumatic grasping forceps Ø 5 mm bndl</b> atraumatic, single fenestrated with cross toothings, double-action	25 mm	8393250	•		•		<b>83932507</b>
		8394250		•	•		<b>83942507</b>
 <b>Atraumatic grasping forceps Ø 5 mm bndl</b> atraumatic, double fenestrated and curved single-action	32 mm	8393229	•		•		<b>83932297</b>
		8394229		•	•		<b>83942297</b>
 <b>Grasping forceps Ø 5 mm bndl</b> atraumatic, narrow and rounded, double-action	15 mm	8393230	•		•		<b>83932307</b>
		8394230		•	•		<b>83942307</b>
 <b>Dissector forceps mono Ø 5 mm bndl</b> curved, double-action	19 mm	8393240	•			•	<b>83932407</b>
		8394240		•		•	<b>83942407</b>
 <b>Dissector forceps mono Ø 5 mm bndl</b> single fenestrated double-action	17 mm	8393242	•		•		<b>83932427</b>
		8394242		•	•		<b>83942427</b>







\* JL = jaw length when jaw section closed (approximate measurements)





HF connection cable: see sheet BDE116/117

**ERAGON** modular  
Ø 5.0 MM, INSULATED

ERAGONMODULAR

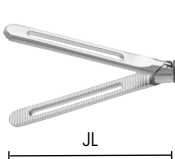
4



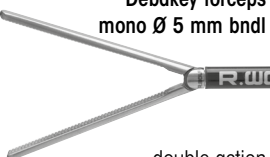





		Handle, axial			
 All jaw inserts and sheath tubes can also be combined with ERAGONaxial					
		with lock	without lock, with HF connector	without lock, with HF connector	with lock, not rotatable
Rotatable knob	Product no.	83930082	83930083	83930084	83930085
	8988	•	•	•	

Jaw insert			Sheath tube, Ø 5.0 mm, insulated		Handle, pistol-shaped		Complete instrument • Jaw insert with sheath tube • Handle
							
	JL*	Product no.	SL 330 mm	SL 450 mm	with lock, without HF	with lock, with HF, mono	Product no.
 Intestine grasping forceps Ø 5 mm bndl atraumatic, single fenestrated with cross toothing, double-action	38 mm	8393249	•		•		<b>83932497</b>
		8394249		•	•		<b>83942497</b>
 Debakey forceps mono Ø 5 mm bndl curved, double-action	35 mm	8393256	•			•	<b>83932567</b>
		8393258	•			•	<b>83932587</b>
 Debakey forceps mono Ø 5 mm bndl double-action	47 mm	8394258		•		•	<b>83942587</b>

\* JL = jaw length when jaw section closed (approximate measurements)  
 HF connection cable: see sheet BDE116/117

III23 || Subject to modifications. Please note that some products may not be available in all countries. Please always take note of the information that is provided with the product. For more detailed information, please consult with your contact partner or directly with Richard Wolf GmbH.

**ERAGON** modular  
Ø 5.0 MM, INSULATED

Jaw insert			Sheath tube, Ø 5.0 mm, insulated		Handle, pistol-shaped	Complete instrument • Jaw insert with sheath tube • Handle
						
			SL 330 mm	SL 450 mm	without lock, with HF, mono	
	JL*	Product no.	8393933	8394933	83930073	Product no.
 23 mm		8393.041	•		•	83930417
	curved, double-action	8394.041		•	•	83940417
 18 mm		8393.044	•		•	83930447
curved, double-action						
 20 mm		8393.045	•		•	83930457
narrow, straight, double-action						
 14 mm		8393.081	•		•	83930817
	serrated, single-action	8394.081		•	•	83940817
 21 mm		8393243	•		•	83932437
	double-action	8394243		•	•	83942437
 26 mm		8393246	•		•	83932467
	curved and toothed double-action	8394246		•	•	83942467







\* JL = jaw length when jaw section closed (approximate measurements)







HF connection cable: see sheet BDE116/117

**ERAGON<sup>modular</sup>**  
 Ø 5.0 MM, INSULATED

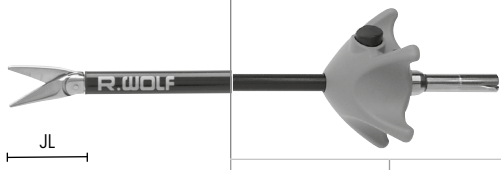
ERAGONMODULAR

4

		Handle, axial			
 All jaw inserts and sheath tubes can also be combined with ERAGONaxial					
		with lock	without lock, with HF connector	without lock, with HF connector	with lock, not rotatable
Rotatable knob	Product no.	83930082	83930083	83930084	83930085
	8988	•	•	•	

Jaw insert		Sheath tube, Ø 5.0 mm, insulated		Handle, pistol-shaped		Complete instrument • Jaw insert with sheath tube • Handle	
		SL 330 mm	SL 450 mm				
	JL*	Product no.	8393933	8394933	83930072	83930073	Product no.
	22 mm	8393248	•			•	<b>83932487</b>
fine-toothed, fine tip double-action		8394248		•		•	<b>83942487</b>
	17 mm	8393.345	•		•		<b>83933457</b>
with distal recess, double-action		8394345		•			<b>83943457</b>
	47 mm	8393253	•		•		<b>83932537</b>
90° articulating with distal slot		8394253		•		•	<b>83942537</b>



\* JL = jaw length when jaw section closed (approximate measurements)

HF connection cable: see sheet BDE116/117

Accessories for manual and machine reprocessing		Product no.
	<b>Irrigation adapter</b> Ø 9 mm, length 64 mm	<b>163502</b>

III23 | Subject to modifications. Please note that some products may not be available in all countries. Please always take note of the information that is provided with the product. For more detailed information, please consult with your contact partner or directly with Richard Wolf GmbH.

**ERAGON<sup>modu</sup> blades**  
 Ø 5.0 MM, INSULATED

		Handle, axial
 All jaw inserts and sheath tubes can also be combined with <b>ERAGONaxial</b>		 without lock, with HF connector
<b>Rotatable knob</b>	<b>Product no.</b>	83930083
	8988	•

Scissors attachment	Tension rod Ø 5.0 mm			Sheath tube insulated Ø 5.0 mm			Handle pistol-shaped	Complete instrument	
								• Jaw insert with sheath tube • Handle	
	for SL 260 mm	for SL 330 mm	for SL 450 mm	SL 240 mm	SL 310 mm	SL 430 mm	without lock, rotatable with HF connector		
	<b>Product no.</b>	8392934	8393934	8394934	8392935	8393935	8394935	83930073	<b>Product no.</b>
<b>Metzenbaum scissors attachment mono</b>	•			•			•	<b>83920407</b>	
 (PACK= 10 PCS), sterile, disposable	4393040		•		•		•	<b>83930407</b>	
			•			•	•	<b>83940407</b>	







11123 || Subject to modifications. Please note that some products may not be available in all countries. Please always take note of the information that is provided with the product. For more detailed information, please consult with your contact partner or directly with Richard Wolf GmbH.







HF connection cable: see sheet BDE116/117

**ERAGON<sup>modular</sup>**  
 Ø 10 MM, UNINSULATED

ERAGONMODULAR

4

		Handle, axial	
 All jaw inserts and sheath tubes can also be combined with <b>ERAGONaxial</b>			
		with lock, without HF connector	with lock, without HF connector, not rotatable
Rotatable knob	Product no.	83930082	83930085
	8988	.	.

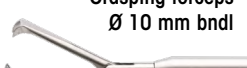





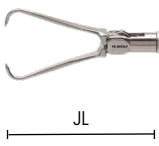

Jaw insert		Sheath tube, Ø 10.0 mm, uninsulated		Handle, pistol-shaped	Complete instrument	
					<ul style="list-style-type: none"> <li>• Jaw insert with sheath tube</li> <li>• Handle</li> </ul>	
		SL 327 mm	SL 447 mm	with lock, without HF		
	JL*	Product no.	8395902	8396902	83930072	Product no.
 Maryland dissector forceps Ø 10 mm bndl	36 mm	8395.225	.	.	.	<b>83952257</b>
		double-action	8396225	.	.	.
 Dissector forceps Ø 10 mm bndl	35 mm	8395.226	.	.	.	<b>83952268</b>
		angled, double-action	8396226	.	.	.
 Grasping forceps Ø 10 mm bndl	20 mm	8395.236	.	.	.	<b>83952368</b>
		Pike-mouth double-action	8396236	.	.	.
 Grasping forceps Ø 10 mm bndl	49 mm	8395.204	.	.	.	<b>83952048</b>
		2/3 jaws single-action	8396204	.	.	.

\* JL = jaw length when jaw section closed (approximate measurements)  
 HF connection cable: see sheet BDE116/117

||| Subject to modifications. Please note that some products may not be available in all countries. Please always take note of the information that is provided with the product. For more detailed information, please consult with your contact partner or directly with Richard Wolf GmbH.

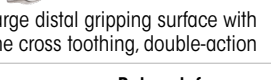

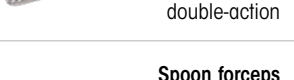
**ERAGON** modular  
Ø 10 MM, UNINSULATED

Jaw insert			Sheath tube, Ø 10.0 mm, uninsulated			Handle, pistol-shaped		Complete instrument • Jaw insert with sheath tube • Handle
			SL 327 mm	SL 447 mm	SL 387 mm	with lock, without HF		
	JL*	Product no.	8395902	8396902	8397902	83930072	83930082	Product no.
 Claw grasping forceps Ø 10 mm bndl double-action	38 mm	8395.489	•			•		83954897
 Claw grasping forceps Ø 10 mm bndl with additional row of teeth, double-action	38 mm	8395490	•			•		83954907
 Babcock forceps Ø 10 mm bndl large distal gripping surface with fine cross toothing, double-action	42 mm	8395.187	•			•		83951877
 Babcock forceps Ø 10 mm bndl double-action		8396187		•		•		83961877
 Babcock forceps Ø 10 mm bndl double-action	38 mm	8395.214	•			•		83952148
 Plate-shaped grasping forceps Ø 10 mm bndl double-action	50 mm	8395.234	•			•		83952347
 Plate-shaped grasping forceps Ø 10 mm bndl double-action		8396234		•		•		83962347
 Spoon forceps Ø 10 mm bndl single-action	31 mm	8395.244	•			•		83952448
 Stapler head grasping forceps Ø 10 mm bndl angled 30°, double-action		8397.655			•		•	83976558



\* JL = jaw length when jaw section closed (approximate measurements)/HF connection cable: see sheet BDE116/117

11123 || Subject to modifications. Please note that some products may not be available in all countries. Please always take note of the information that is provided with the product. For more detailed information, please consult with your contact partner or directly with Richard Wolf GmbH.

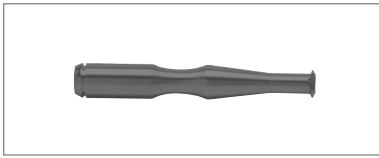
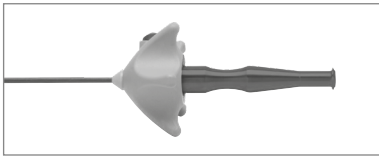
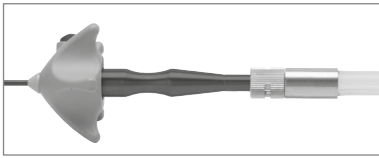
**ERAGON** modular  
ACCESSORIES

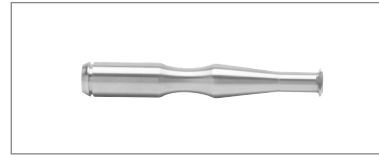
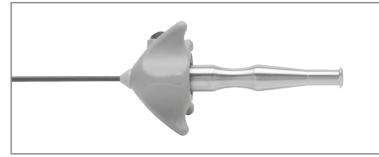
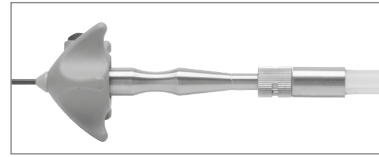



For insulated sheath tubes		Product no.
	For manual and machine reprocessing:  <b>Irrigation adapter</b> Ø 9 mm, length 64 mm for insulated sheath tubes	<b>163502</b>
		





For uninsulated sheath tubes		Product no.
	For manual and machine reprocessing:  <b>Irrigation adapter cleaning</b> Ø 9 mm, length 64 mm for uninsulated sheath tubes	<b>163503</b>
		



	<b>8393932</b>
	<b>8394932</b>

		Ø	SL	Product no.
	<b>Sheath tube insulated Ø 5 mm SL 330 mm</b> with distal cm scale	5 mm	330 mm	<b>8393932</b>
	<b>Sheath tube insulated Ø 5 mm SL 450 mm</b> with distal cm scale	5 mm	450 mm	<b>8394932</b>

## HANDLE VARIANTS FOR MODULAR SYSTEMS

Handle, pistol-shaped 	rotatable	with lock	without lock	with HF	without HF	Product no.
	•	•			•	83930072
	•		•	•		83930073
	•	•		•		83930074

Handle, axial 	rotatable	with lock	without lock	with HF	without HF	Product no.
	•	•			•	83930082
	•		•	•		83930083
	•	•		•		83930084
		•			•	83930085

Optional for 83930082/83930083/83930084:		Product no.
 	Rotatable knob autoclavable	8988

All ERAGON<sup>modular</sup> components are compatible with ERAGON<sup>axial</sup>

# CHOLANGIOGRAPHY CATHETERGRASPING FORCEPS 5 MM

FORCEPS

5

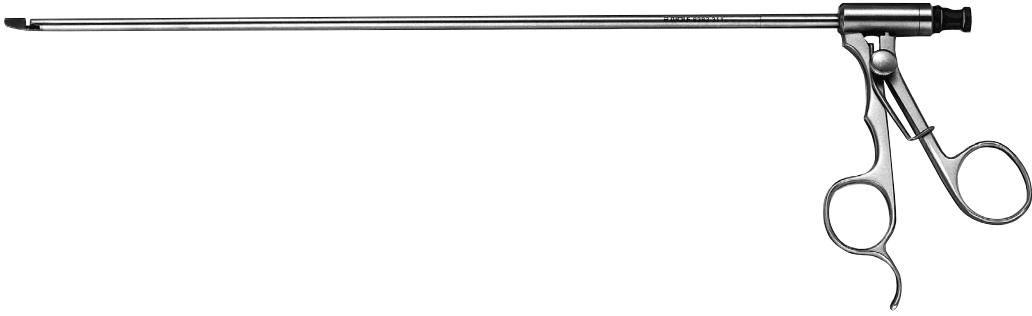







		Outer Ø	WL	Product no.
	Grasping forceps Ø 5 mm WL 295 mm	5.0 mm	295 mm	<b>8383.311</b>

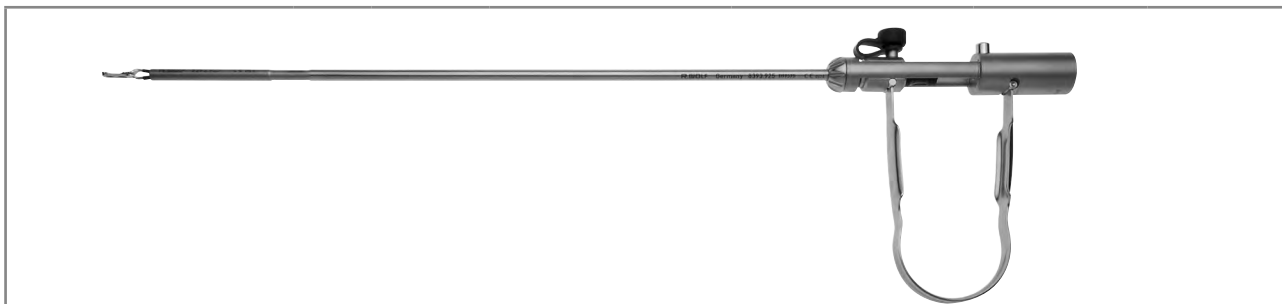

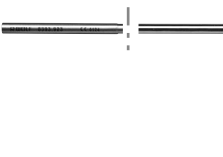

- For inserting a cholangiography catheter up to 7 Fr into the cystic duct

# BIPOLAR FORCEPS 3.5 MM/5.0 MM

WITH SPRING HANDLE  
MODULAR SYSTEM

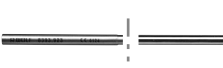

Grasping forceps jaw insert			Outer tube Ø 3.5 mm SL 348 mm	Screw cap with sleeve Ø 5.0 mm SL 107 mm	Spring handle bipo	complete instrument • Jaw insert • Sliding sleeve • Outer tube • Spring handle
						
	JL*	Product no.	8391.921	8393.978	8393.975	Product no.
	39 mm	8391.715	•	•	•	<b>8391.742</b>







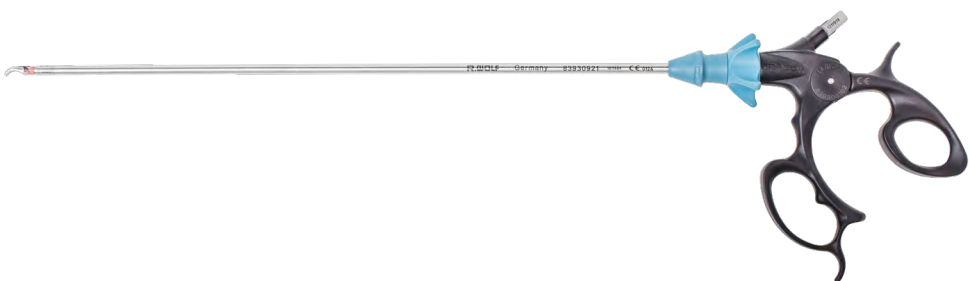

Kleppinger grasping forceps jaw insert			Sliding sleeve SL 319 mm	Outer tube Ø 5 mm SL 237 mm	Spring handle bipo	complete instrument • Jaw insert • Sliding sleeve • Outer tube • Spring handle
						
	JL*	Product no.	8393.923	8393.925	8393.975	Product no.
	53 mm	8393.714	•	•	•	<b>8393.741</b>

Accessories	Product no.
RIWO rubber cap, jet black	15220.019
Luer sealing cap	15023.153

\* JL = jaw length when jaw section closed (approximate measurements)  
Bipolar connection cable: see sheet BDE118/119

11123 || Subject to modifications. Please note that some products may not be available in all countries. Please always take note of the information that is provided with the product. For more detailed information, please consult with your contact partner or directly with Richard Wolf GmbH.





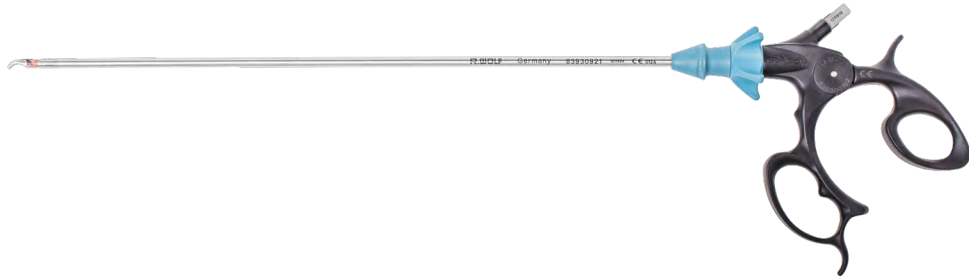

**ERAGON** bipolar  
MODULAR BIPOLAR INSTRUMENTS, 5.5 MM  
ROTATABLE

						
		Jaw insert	Sheath tube Ø 5.5 mm		Handle, pistol-shaped, bipo	<b>Complete instrument</b> • Jaw insert • Sheath tube • Handle
			SL 320 mm	SL 435 mm	 rotatable	
	JL*	Product no.	83930921	82340024	839300102	Product no.
 Grasping forceps bipo Ø 5.5 mm bndl	21 mm	83930031	•		•	<b>839300312</b>
		839400310			•	<b>839400312</b>
 Maryland dissector bipo Ø 5.5 mm bndl	23 mm	83930032	•		•	<b>839300322</b>
		839400320			•	<b>839400322</b>
 Dolphin dissector bipo Ø 5.5 mm bndl	21 mm	83930033	•		•	<b>839300332</b>
		839400330			•	<b>839400332</b>
 Grasping forceps bipo Ø 5.5 mm bndl	23 mm	83930034	•		•	<b>839300342</b>
		839400340			•	<b>839400342</b>
 Preparation forceps bipo Ø 5.5 mm bndl	19 mm	83930035	•		•	<b>839300352</b>
		839400350			•	<b>839400352</b>

\* JL = jaw length when jaw section closed (approximate measurements)  
Bipolar connection cable: see sheet BDE118/119

**ERAGON** bipolar  
MODULAR BIPOLAR INSTRUMENTS, 5.5 MM,  
ROTATABLE



Jaw insert			Sheath tube Ø 5.5 mm		Handle, pistol-shaped, bipo	Complete instrument • Jaw insert • Sheath tube • Handle
						
			SL 320 mm	SL 435 mm	rotatable	
	JL*	Product no.	83930921	82340024	839300102	Product no.
 Sterilization forceps bipo Ø 5.5 mm bndl as per Hasskamp	19 mm	83930036	•		•	839300362
 Münster grasping forceps bipo Ø 5.5 mm bndl	22 mm	83930037	•		•	839300372
		83930038	•		•	839300382
 Maryland dissector bipo Ø 5.5 mm bndl	15 mm	839400380		•	•	839400382
 Metzenbaum scissors bipo Ø 5.5 mm bndl	22 mm	83930041	•		•	839300412
		839400410		•	•	839400412

\* JL = jaw length when jaw section closed (approximate measurements)  
Bipolar connection cable: see sheet BDE118/119

11123 || Subject to modifications. Please note that some products may not be available in all countries. Please always take note of the information that is provided with the product. For more detailed information, please consult with your contact partner or directly with Richard Wolf GmbH.



# ELECTRODES 2.0 MM/3.5 MM

## MONOPOLAR





ELECTRODES

7



		Outer Ø	WL	Product no.
	Coagulation electrode mono 5 FR WL 400 mm	1.67 mm	400 mm	<b>823.05</b>
	Coagulation electrode mono 6 FR WL 400 mm	2.0 mm	400 mm	<b>823.06</b>



		Outer Ø	WL	Product no.
	Hook electrode mono Ø 3.5 mm WL 310 mm	3.5 mm	310 mm	<b>8379.452</b>
	Hook electrode mono Ø 3.5 mm WL 240 mm with distally extended insulation	3.5 mm	240 mm	<b>8785.642</b>
	Needle electrode mono Ø 3.5 mm WL 310 mm	3.5 mm	310 mm	<b>8379.482</b>
	Coagulation electrode mono Ø 3.5 mm WL 310 mm	3.5 mm	310 mm	<b>8379.462</b>

HF connection cable: see sheet BDE116/117







# ELECTRODES 5.0 MM

## MONOPOLAR



		Outer Ø	WL	Product no.
	Coagulation electrode mono Ø 5 mm WL 330 mm	5.0 mm	330 mm	<b>8383.40</b>
	Coagulation electrode mono Ø 5 mm WL 450 mm	5.0 mm	450 mm	<b>8384.40</b>



		Outer Ø	WL	Product no.
	Hook electrode mono Ø 5 mm WL 340 mm	5.0 mm	340 mm	<b>8383.423</b>
	Hook electrode mono Ø 5 mm WL 420 mm		420 mm	<b>8384.423</b>
	Needle electrode mono Ø 5 mm WL 340 mm	5.0 mm	340 mm	<b>8383.426</b>
	Spatula electrode mono Ø 5 mm WL 340 mm	5.0 mm	340 mm	<b>8383.428</b>
	Myoma dissector mono Ø 5 mm WL 340 mm	5.0 mm	340 mm	<b>8383429</b>

HF connection cable: see sheet BDE116/117

# MULTIFUNCTIONAL SUCTION IRRIGATION SYSTEM

## COMBINATION OPTIONS

MULTIFUNCTIONAL SUCTION IRRIGATION SYSTEM

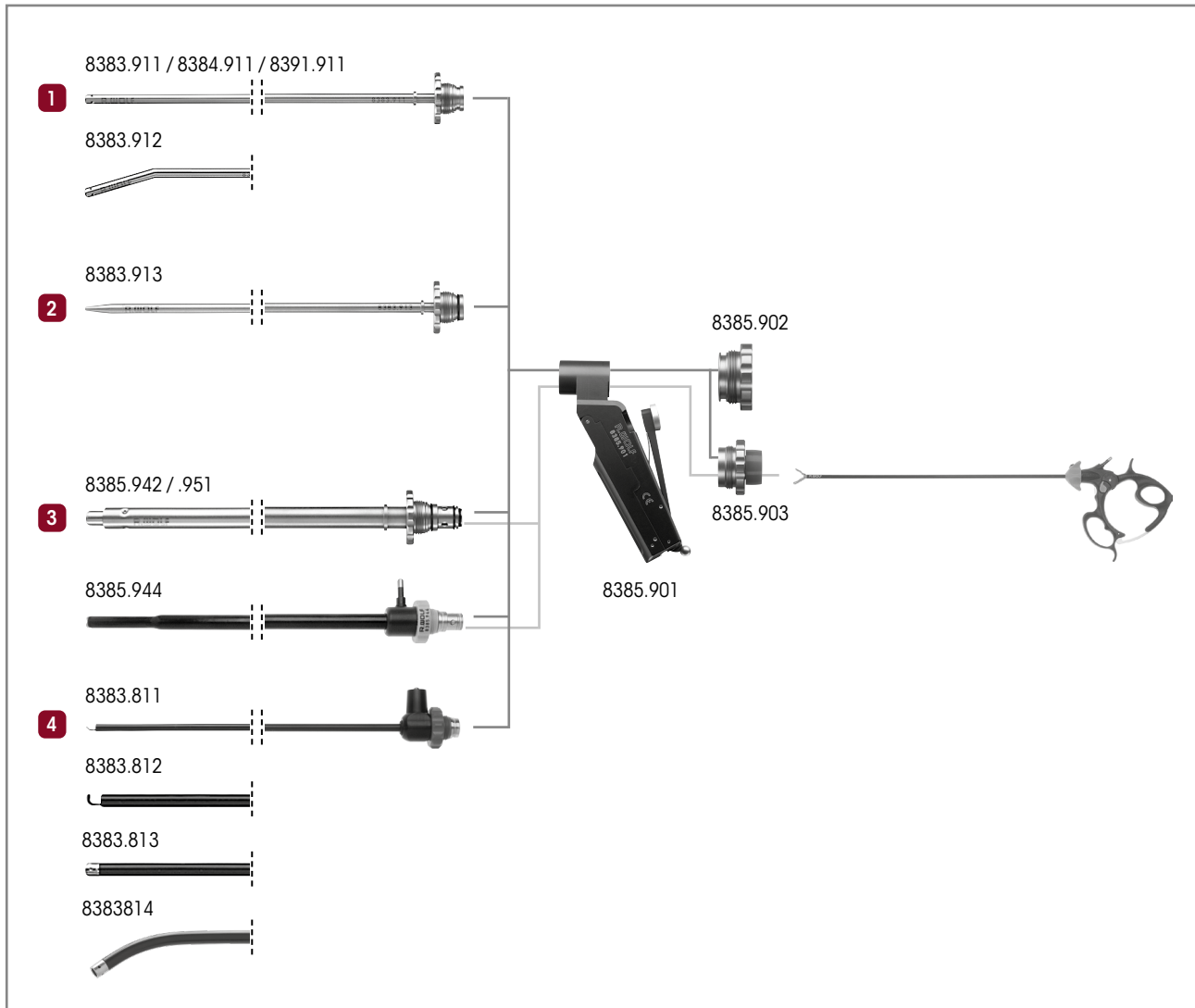

- 1 Suction or irrigation:**
- Suction irrigation tube Ø 5 mm WL 310 mm ..... 8383.911
  - Suction irrigation tube Ø 5 mm WL 450 mm ..... 8384.911
  - Suction irrigation tube Ø 3.5 mm WL 300 mm ..... 8391.911
  - Suction irrigation tube curved Ø 5 mm WL 310 mm... 8383.912
  - for this: **Sealing cap** ..... 8385.902

- 2 Blunt aquadissection:**
- Pressure irrigation tube Ø 5 mm WL 310 mm ..... 8383.913
  - for this: **Sealing cap** ..... 8385.902

- 3 Suction, irrigation, and use of auxiliary instruments Ø 5 mm:**
- Suction irrigation tube Ø 10 mm WL 225 mm ..... 8385.942
  - Suction irrigation tube Ø 10 mm WL 330 mm ..... 8385.951
  - Suction irrigation tube Ø mono 10 mm WL 330 mm, insulated, with atraumatic preparation tip ..... 8385.944
  - for this: **Sealing adapter** ..... 8385.903

- 4 Preparation of tissue with HF:**
- HF suction irrigation tube Ø 5.2 mm WL 317 mm** insulated with integrated HF spatula probe ..... 8383.811
  - HF suction irrigation tube Ø 5.2 mm WL 317 mm** insulated with integrated HF hook electrode ..... 8383.812
  - HF suction irrigation tube Ø 5.2 mm WL 317 mm** insulated with integrated HF button electrode ..... 8383.813
  - HF suction irrigation tube Ø 5.4 mm WL 380 mm** curved with distal openings, insulated with integrated HF button electrode ..... 8383.814
  - for this: **Sealing cap** ..... 8385.902

III23 || Subject to modifications. Please note that some products may not be available in all countries. Please always take note of the information that is provided with the product. For more detailed information, please consult with your contact partner or directly with Richard Wolf GmbH.

# MULTIFUNCTIONAL SUCTION IRRIGATION SYSTEM

## SUCTION IRRIGATION HANDLE

 <p>8385.901</p> <p><b>AUTOGLAVE</b> <b>134° C / 273° F</b></p> <p>8385.902</p> <p>8385.903</p>	
	<b>Product no.</b>
<p><b>Suction irrigation handle</b></p>	<b>8385.901</b>
<p><b>Sealing cap</b></p>	<b>8385.902</b>
<p>Required to use auxiliary instruments Ø 5 mm: <b>Sealing attachment</b> with opening and membrane valve</p>	<b>8385.903</b>
<p>Spare <b>Sealing membrane Ø 17 mm</b> yellow, Ø 17 mm, PACK= 10 PCS, for instruments from 3 to 6 mm</p>	<b>89.103</b>

# MULTIFUNCTIONAL SUCTION IRRIGATION SYSTEM

## SUCTION IRRIGATION TUBE SETS – ILLUSTRATION

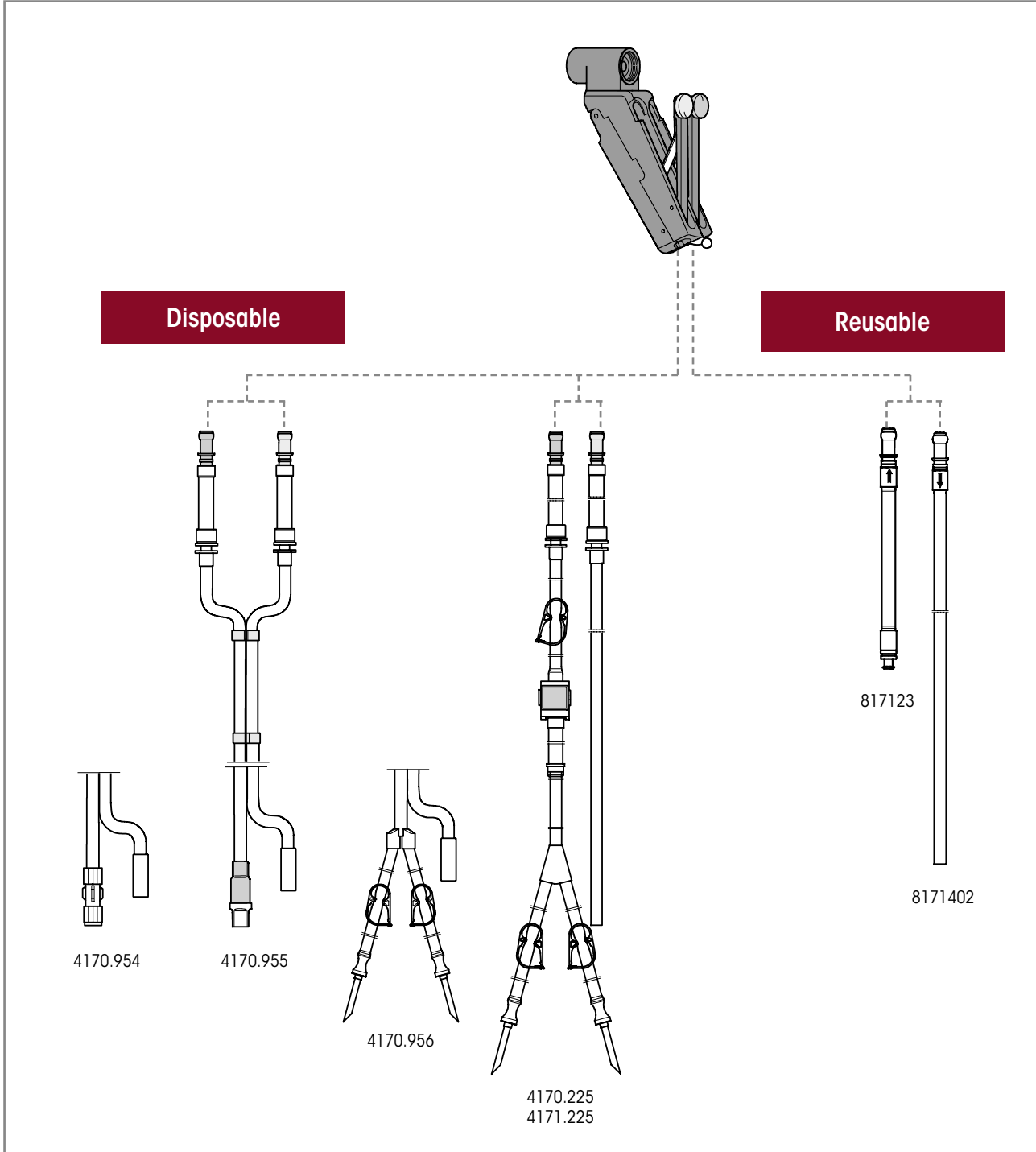

**Suction irrigation tube sets** are used in conjunction with the suction irrigation handle 8385.901 and pump-side tube systems as well as corresponding collection and secretion containers and/or vacuum pumps (e.g., FLUID CONTROL LAP 2216, LAPARO PUMP 2215)







# MULTIFUNCTIONAL SUCTION IRRIGATION SYSTEM

## SUCTION IRRIGATION TUBE SETS FOR SUCTION IRRIGATION HANDLE 8385.901

Disposable		Product no.
<b>Suction irrigation tube set, L 3 m</b>  (PACK= 10 PCS), sterile	<b>Irrigation tube:</b> With Luer-Lock, for connection to the irrigation tube of a suction irrigation tube set, e.g., irrigation tube of the Endo-Irrigator 2211 <b>Suction tube:</b> For connection to a collection or secretion container and/or vacuum pump	<b>4170.954</b>
<b>Suction irrigation tube set with care-lock, L 3 m</b>  (PACK= 10 PCS), sterile	<b>Irrigation tube:</b> With CARE-LOCK, for connection to an irrigation container <b>Suction tube:</b> For connection to a collection or secretion container and/or vacuum pump	<b>4170.955</b>
<b>Suction irrigation tube set with piercing spike, L 3 m</b>  (PACK= 10 PCS), sterile	<b>Irrigation tube:</b> With 2 piercing spikes, for connection to an irrigation container <b>Suction tube:</b> For connection to a collection or secretion container and/or vacuum pump	<b>4170.956</b>
<b>Suction irrigation tube set with piercing spike, L 3 m</b>  (PACK= 10 PCS), sterile	<b>Irrigation tube:</b> With 2 piercing spikes, for connection to an irrigation container, plus Laparo Pump 2215 and Fluid Control Lap 2216 <b>Suction tube:</b> For connection to a collection or secretion container and/or vacuum pump  Also observe instruction manual GA-A 167	<b>4170.225</b>
<b>Suction irrigation tube set, L 3 m</b>  (PACK= 10 PCS), sterile	<b>Irrigation tube:</b> With 2 piercing spikes, for connection to an irrigation container, and Fluid Control Lap 2216 <b>Suction tube:</b> For connection to a collection or secretion container and/or vacuum pump  Also observe instruction manual GA-A 276	<b>4171.225</b>
<b>Secretion container, 2.5 l</b>	2.5 liters (PACK= 2 PCS)	<b>41706566</b>
<b>Tube set for suction (2 connections)</b>	sterile disposable product (PACK= 10 PCS), for connecting instruments to collecting container	<b>T0503-01</b>
Reusable		Product no.
<b>Irrigation tube L 1.2 m</b>	<b>Irrigation tube:</b> With Luer-Lockconnection for connection to the irrigation tube of a suction irrigation tube set, e.g., 8171223 or 8170.223	<b>817123</b>
<b>Suction tube L 3 m</b>	silicone, for suction irrigation handle 8385.901	<b>8171402</b>
<b>Secretion container, 2 l</b>	2 liters, with lid	<b>8170.655</b>
<b>Secretion container, 2 l</b>	2 liters, no lid	<b>8170.6551</b>

# MULTIFUNCTIONAL SUCTION IRRIGATION SYSTEM





## SUCTION IRRIGATION TUBES

		Outer Ø	WL	Product no.
				
	Suction irrigation tube Ø 3.5 mm WL 300 mm	3.5 mm	300 mm	<b>8391.911</b>
	Suction irrigation tube Ø 5 mm WL 310 mm	5.0 mm	310 mm	<b>8383.911</b>
	Suction irrigation tube Ø 5 mm WL 450 mm	5.0 mm	450 mm	<b>8384.911</b>
	Suction irrigation tube curved Ø 5 mm WL 310 mm	5.0 mm	310 mm	<b>8383.912</b>
	Pressure irrigation tube Ø 5 mm WL 310 mm	5.0 mm	310 mm	<b>8383.913</b>
for use of 5 mm auxiliary instruments				
 capacity 5.0 mm	Suction irrigation tube Ø 10 mm WL 225 mm	10.0 mm	225 mm	<b>8385.942</b>
	Suction irrigation tube Ø 10 mm WL 330 mm	10.0 mm	330 mm	<b>8385.951</b>
 insulated, with atraumatic preparation tip	Suction irrigation tube mono Ø 10 mm WL 330 mm	10.0 mm	330 mm	<b>8385.944</b>
	required for 8385.951:  <b>Sealing attachment</b> with opening and membrane valve Sealing membrane Ø 17 mm			<b>8385.903</b>

# MULTIFUNCTIONAL SUCTION IRRIGATION SYSTEM

## SUCTION IRRIGATION TUBES



		Outer Ø	WL	Product no.
 insulated with integrated HF spatula probe	<b>HF suction irrigation tube Ø 5.2 mm WL 317 mm</b>	5.2 mm	317 mm	<b>8383.811</b>
 insulated with integrated HF hook probe	<b>HF suction irrigation tube Ø 5.2 mm WL 317 mm</b>	5.2 mm	317 mm	<b>8383.812</b>
 insulated with integrated HF button electrode	<b>Suction irrigation tube Ø 5 mm WL 450 mm</b>	5 mm	317 mm	<b>8383.813</b>
as alternative to suction irrigation handle:				
	<b>Suction irrigation adapter</b> with maintenance-free two-way stopcock, for multifunctional suction irrigation system			<b>8583819</b>







Accessories	Product no.
HF connection cable	See page BDE116/117

11123 || Subject to modifications. Please note that some products may not be available in all countries. Please always take note of the information that is provided with the product. For more detailed information, please consult with your contact partner or directly with Richard Wolf GmbH.

# MULTIFUNCTIONAL SUCTION IRRIGATION SYSTEM

## SUCTION IRRIGATION TUBES





		Outer Ø	WL	Product no.
	Suction tube OD 2.8 mm WL 450 mm	2.8 mm	450 mm	<b>8380.68</b>
	Suction irrigation tube Ø 5 mm WL 310 mm	5.0 mm	310 mm	<b>8383.911</b>
	Suction irrigation tube Ø 5 mm WL 450 mm	5.0 mm	450 mm	<b>8384.911</b>
	Suction irrigation tube curved Ø 5 mm WL 310 mm	5.0 mm	310 mm	<b>8383.912</b>
	Pressure irrigation tube Ø 5 mm WL 310 mm	5.0 mm	310 mm	<b>8383.913</b>
for use of 5 mm auxiliary instruments				
 capacity 5.0 mm	Suction irrigation tube Ø 10 mm WL 225 mm	10.0 mm	225 mm	<b>8385.942</b>
	Suction irrigation tube Ø 10 mm WL 330 mm	10.0 mm	330 mm	<b>8385.951</b>
 insulated, with atraumatic preparation tip	Suction irrigation tube mono Ø 10 mm WL 330 mm	10.0 mm	330 mm	<b>8385.944</b>
	required for 8385.951:  <b>Sealing attachment</b> with opening and membrane valve, sealing membrane Ø 17 mm			<b>8385.903</b>

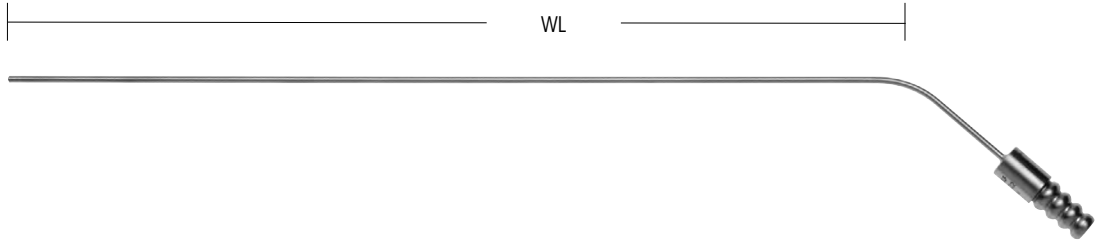

## ACCESSORIES FOR SUCTION AND IRRIGATION



		Outer Ø	WL	Product no.
 central, lateral openings, rigid	suction tube OD 2 mm WL 250 mm	2.0 mm	250 mm	<b>8291.22</b>
	suction tube OD 2.5 mm WL 250 mm	2.5 mm	250 mm	<b>8291.23</b>
	suction tube OD 3 mm WL 250 mm	3.0 mm	250 mm	<b>8291.24</b>
	suction tube OD 4 mm WL 500 mm	4.0 mm	500 mm	<b>8291.45</b>





		Outer Ø	WL	Product no.
	Suction tube OD 2.8 mm WL 450 mm	2.8 mm	450 mm	<b>8380.68</b>

11123 || Subject to modifications. Please note that some products may not be available in all countries. Please always take note of the information that is provided with the product. For more detailed information, please consult with your contact partner or directly with Richard Wolf GmbH.

## ACCESSORIES FOR SUCTION AND IRRIGATION

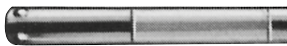

		Outer Ø	WL	Product no.
	Suction tube graduated Ø 5 mm WL 330 mm	5.0 mm	330 mm	<b>8383.68</b>
graduated, with 3 mm Luer connector				





		Outer Ø	WL	Product no.
	Suction irrigation tube Ø 5 mm WL 300 mm	5.0 mm	300 mm	<b>8383.94</b>
with stop valve				





		Outer Ø	WL	Product no.
	Suction irrigation tube WL 290 mm	5.0 mm	290 mm	<b>8583732</b>
with maintenance-free two-way stopcock, sheath tube, with distal openings, reusable				
	Suction irrigation tube WL 410 mm	5.0 mm	410 mm	<b>8584732</b>

## ACCESSORIES / DISPOSABLE HAND BLOWER FOR SUCTION AND IRRIGATION



		Outer Ø	WL	Product no.
	<b>Suction irrigation tube Ø 3 mm WL 300 mm</b>	3.0 mm	330 mm	<b>8383.72</b>
with Luer connector				



		Outer Ø	WL	Product no.
	<b>HF coagulation suction device mono Ø 5 mm WL 315 mm</b>	5.0 mm	315 mm	<b>8383.71</b>
with Luer connector and a valve	<b>HF coagulation suction device mono Ø 5 mm WL 350 mm</b>	5.0 mm	450 mm	<b>8384.71</b>

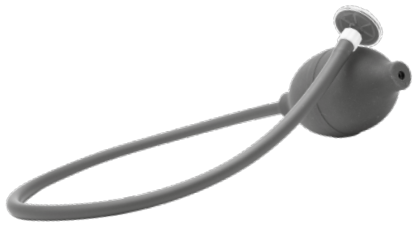

for air insufflation		Ø	TL	Product no.
	<b>Hand blower with disposable filter, sterile (PACK= 5 PCS)</b>	49 mm	567 mm	<b>412700</b>

HF connection cable: see sheet BDE116/117

# TISSUE RETRACTOR 5 MM

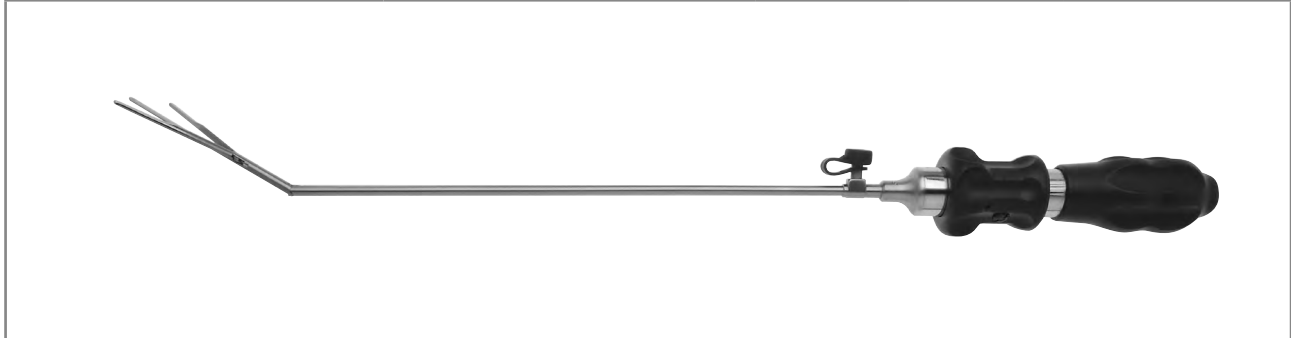



		Outer Ø	WL	Product no.
	tissue retractor Ø 5 mm WL 320 mm	5.0 mm	320 mm	<b>8383.691</b>

Accessories	Product no.
Luer sealing cap	<b>887.00</b>

III23 || Subject to modifications. Please note that some products may not be available in all countries. Please always take note of the information that is provided with the product. For more detailed information, please consult with your contact partner or directly with Richard Wolf GmbH.

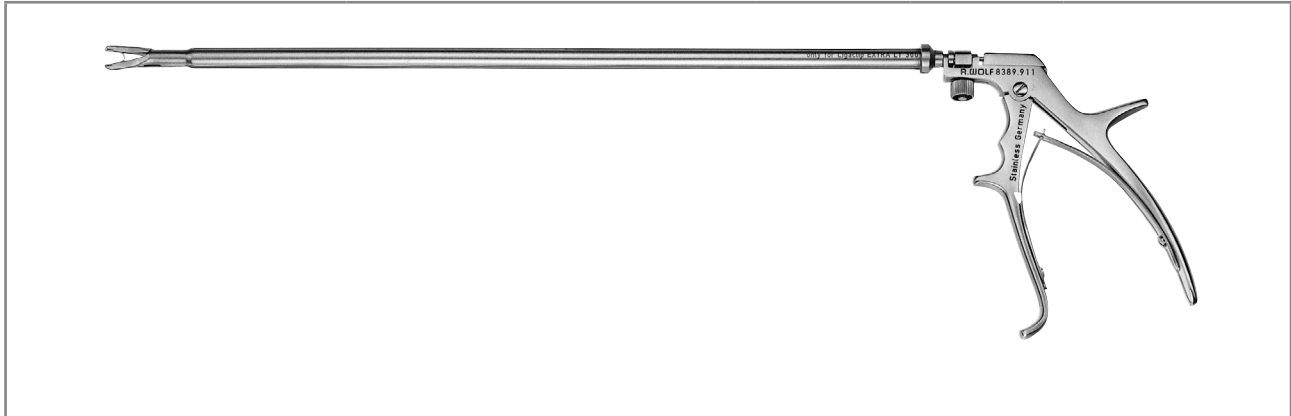
# CLIP APPLICATOR 10 MM FOR SUCTION AND IRRIGATION



		Outer Ø	WL	Product no.
	<b>Clip applicator</b> Ø 10 mm WL 340 mm	10 mm	340 mm	<b>8389.911</b>
<b>for this:</b>				<b>Product no.</b>
	<b>Introduction sleeve 10 mm WL 80 mm</b> with sealing cap			<b>8389.991</b>
For clip ligation with Ethicon® Ligaclip® EXTRA LT 300				
<b>Ethicon® Ligaclips®</b> (PACK= 108 PCS)				<b>8389.915</b>

Accessories	Product no.
Sealing cap capacity 9.5–10.1 mm	<b>89.08</b>

CLIP APPLICATOR

10

11123 || Subject to modifications. Please note that some products may not be available in all countries. Please always take note of the information that is provided with the product. For more detailed information, please consult with your contact partner or directly with Richard Wolf GmbH.

# ERAGON<sup>stitch</sup>

## THE ERGONOMIC GENERATION OF NEEDLE HOLDERS

Thanks to the custom combination options it offers, **ERAGON<sup>stitch</sup>** can accommodate any user requirement. The way in which it brings together ergonomics, versatility, modularity, and precision sets new standards in comfort

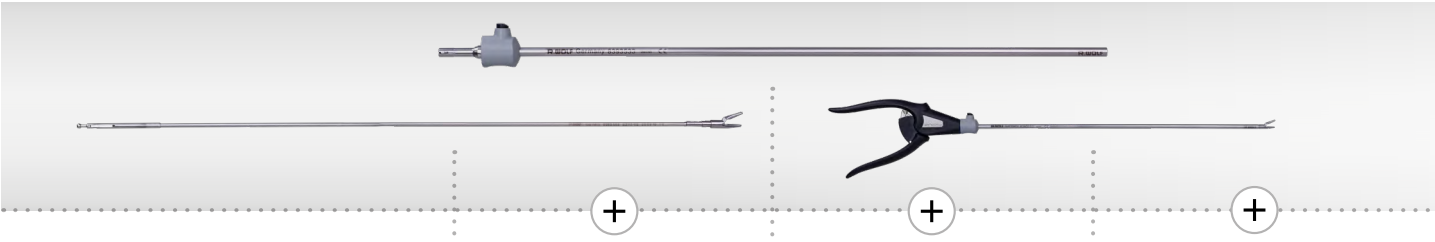

Choose working length      Choose jaw insert      Choose sheath tube      Choose handle

Needle Diameter (∅)	Working Length Options	Jaw Insert Options	Sheath Tube Options	Handle Options
5.0 mm	330 mm 450 mm	5 different designs	1 design	1 design
3.5 mm	240 mm 330 mm	1 design	1 design	1 design

ERAGONSTITCH NEEDLE HOLDER





11

**ERAGONstitch needle holders**



**ERAGON<sup>stitch</sup>**  
NEEDLE HOLDER Ø 3.5 MM



Needle holder jaw insert			Sheath tube, Ø 3.5 mm		Needle holder handle		Complete instrument • Jaw insert • Sheath tube • Handle
							
							SL 240 mm
					Axial	Angled	
	JL*	Product no.	8390533	8391533	8393943	8393944	Product no.
	12 mm	Needle holder jaw insert Ø 3.5 mm bndl	•		•		<b>83915053</b>
		8391505	•			•	<b>83915054</b>
straight with carbide insert single-action		8391506		•	•		<b>83915063</b>
				•		•	<b>83915064</b>

\* JL = jaw length when jaw section closed (approximate measurements)





Accessories for manual and machine reprocessing	Product no.
	<b>Irrigation adapter cleaning</b> Ø 9 mm, length 64 mm for uninsulated sheath tubes  <b>163503</b>

1123 || Subject to modifications. Please note that some products may not be available in all countries. Please always take note of the information that is provided with the product. For more detailed information, please consult with your contact partner or directly with Richard Wolf GmbH.



# ERAGON<sup>stitch</sup>



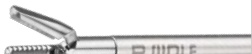

## NEEDLE HOLDER Ø 5.0 MM

Needle holder jaw insert			Sheath tube, Ø 5.0 mm		Needle holder handle		Complete instrument • Jaw insert • Sheath tube • Handle	
								
	JL*	Product no.	8393533	8394533	8393943	8393944	Product no.	
	19 mm	8393507	•		•		83935073	
			•			•	83935074	
straight with carbide insert single-action	19 mm	8394507		•	•		83945073	
				•		•	83945074	
	19 mm	8393508	•		•		83935083	
			•			•	83935084	
straight and narrow with carbide insert single-action	19 mm	8394508		•	•		83945083	
				•		•	83945084	
	19 mm	8393509	•		•		83935093	
			•			•	83935094	
straight, with self-righting function single-action	19 mm	8394509		•	•		83945093	
				•		•	83945094	

\* JL = jaw length when jaw section closed (approximate measurements)

Accessories for manual and machine reprocessing		Product no.
	<b>Irrigation adapter cleaning</b> Ø 9 mm, length 64 mm for uninsulated sheath tubes	<b>163503</b>

**ERAGON** *stitch*  
NEEDLE HOLDER Ø 5.0 MM













Needle holder jaw insert			Sheath tube, Ø 5.0 mm		Needle holder handle		Complete instrument • Jaw insert • Sheath tube • Handle	
								
	JL*	Product no.	8393533	8394533	Axial	Angled	Product no.	
 Needle holder Ø 5 mm bndl	19 mm	8393518	•		•		<b>83935183</b>	
			•			•	<b>83935184</b>	
	curved right with carbide insert single-action	8394518		•	•			<b>83945183</b>
				•		•		<b>83945184</b>
 Needle holder Ø 5 mm bndl	19 mm	8393519	•		•		<b>83935193</b>	
				•		•	<b>83935194</b>	
	Curved left with carbide insert single-action	8394519		•	•			<b>83945193</b>
				•		•		<b>83945194</b>

Accessories for manual and machine reprocessing	Product no.
 Irrigation adapter cleaning Ø 9 mm, length 64 mm for uninsulated sheath tubes	<b>163503</b>

III23 || Subject to modifications. Please note that some products may not be available in all countries. Please always take note of the information that is provided with the product. For more detailed information, please consult with your contact partner or directly with Richard Wolf GmbH.

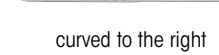
# NEEDLE HOLDER Ø 3.5 MM/5 MM

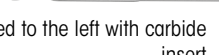
## MODULAR SYSTEM

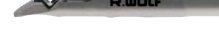

					
<b>Needle holder jaw insert with sheath</b>				<b>Needle holder handle, axial</b>	
					
				single-action locking mechanism, can be disabled	
	Product no.	Ø	SL	8393.941	Complete instrument • Jaw insert • Sheath tube • Handle
	Product no.				
 with carbide insert	8391504	3.5 mm	340 mm	•	<b>8391.501</b>
 for straight needles	8393504	5 mm	340 mm	•	<b>8393.501</b>
 with carbide insert	8393505	5 mm	340 mm	•	<b>8393.502</b>
 with carbide insert	8394505	5 mm	430 mm	•	<b>8394.502</b>
 curved to the right with carbide insert	8393514	5 mm	340 mm	•	<b>8393.511</b>
 curved to the right with carbide insert	8394514	5 mm	430 mm	•	<b>8394.511</b>
 curved to the left with carbide insert	8393515	5 mm	340 mm	•	<b>8393.512</b>
 curved to the left with carbide insert	8394515	5 mm	430 mm	•	<b>8394.512</b>
 Sarbu needle holder Ø 5 mm bndl	8393506	5 mm	340 mm	•	<b>8393.503*</b>
 Sarbu needle holder Ø 5 mm bndl	8394506	5 mm	430 mm	•	<b>8394.503*</b>

\* with automatic needle placement apparatus and cutting edge

1123 || Subject to modifications. Please note that some products may not be available in all countries. Please always take note of the information that is provided with the product. For more detailed information, please consult with your contact partner or directly with Richard Wolf GmbH.

# NEEDLE HOLDER HANDLE







Needle holder handle, axial	not rotatable	with lock	without HF	Product no.
	•	•	•	<b>8393.941</b>



Needle holder handle <small>ERAGON</small> <small>stitch</small>	axial	angled	with on-off detent mechanism	single-action	Not rotatable	Product no.
	•		•	•	•	<b>8393943</b>
		•	•	•	•	<b>8393944</b>

III23 || Subject to modifications. Please note that some products may not be available in all countries. Please always take note of the information that is provided with the product. For more detailed information, please consult with your contact partner or directly with Richard Wolf GmbH.

**ERAGON**<sub>modular</sub>

**MODULAR KNOT PUSHER Ø 5.0 MM, INSULATED**

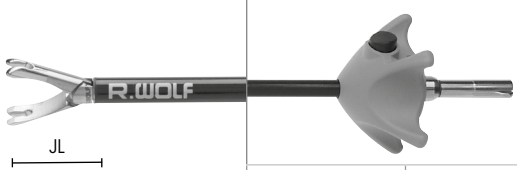
		Handle, axial			
 All jaw inserts and sheath tubes can also be combined with <b>ERAGONaxial</b>					
		with lock	without lock, with HF connector	without lock, with HF connector	with lock, not rotatable
<b>Rotatable knob</b>	<b>Product no.</b>	83930082	83930083	83930084	83930085
	8988	•	•	•	•

Jaw insert		Sheath tube, Ø 5.0 mm, insulated		Handle	Complete instrument • Jaw insert with sheath tube • Handle	
  JL		SL 330 mm	SL 450 mm	 with lock, without HF		
	JL*	<b>Product no.</b>	8393933	8394933	83930072	<b>Product no.</b>
<b>Knot pusher Ø 5 mm bndl</b>	17 mm	8393.345	•		•	<b>83933457</b>
with distal recess, double-action		8394345		•	•	<b>83943457</b>

KNOT PUSHER

11



\* JL = jaw length when jaw section closed (approximate measurements)

HF connection cable: see sheet BDE116/117

1123 || Subject to modifications. Please note that some products may not be available in all countries. Please always take note of the information that is provided with the product. For more detailed information, please consult with your contact partner or directly with Richard Wolf GmbH.

# KNOT PUSHER 5 MM FOR ENDOSCOPIC SUTURING



		Outer Ø	WL	TL	Product no.
	<b>Knot pusher Ø 3.7 mm WL 330 mm</b> for intraabdominal knots	3.7 mm	330 mm	380 mm	<b>8383.55</b>
	<b>Knot pusher Ø 3.7 mm WL 330 mm</b> for extracorporeal knots	3.7 mm	330 mm	380 mm	<b>8383.551</b>





		Outer Ø	WL	TL	Product no.
	<b>Knot pusher Ø 5 mm WL 330 mm</b> as per Bueß with distal notch and lateral opening for optimum knotting, extremely atraumatic tip for use as a surgical probe	5.0 mm	330 mm	380 mm	<b>8383.552</b>

|||23 || Subject to modifications. Please note that some products may not be available in all countries. Please always take note of the information that is provided with the product. For more detailed information, please consult with your contact partner or directly with Richard Wolf GmbH.

# Endoscopically controlled fascia closure system

## AS PER BUSCHE



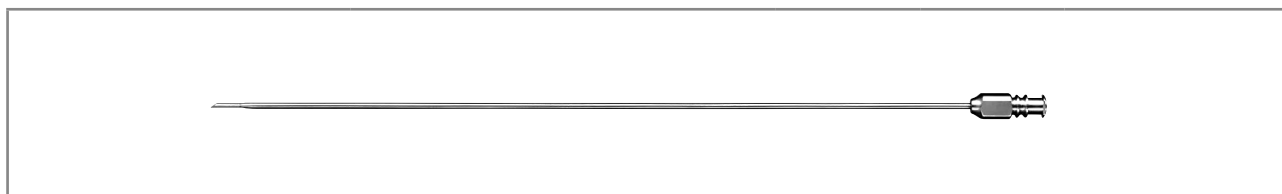

				Product no.
 for subcutaneous fascia suture	Sealing cone Ø 10–12 mm			8934.915
	Sealing cone Ø 12–15 mm			8943.915
	Sealing cone Ø 15–20 mm			8945.915
		Ø	WL	Product no.
 Needle forceps with active suture holder	Needle forceps Ø 2.45 mm WL 160 mm	2.45 mm	160 mm	8756.201

## CANNULAS 3.0 MM/4.7 MM



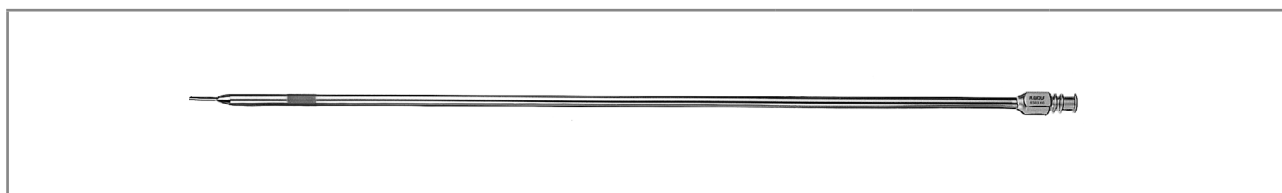

with Luer connector		Outer Ø	WL	Product no.
 Tip Ø 1.4 mm	Injection cannula Ø 3 mm WL 340 mm	3.0 mm	340 mm	<b>8379.732</b>

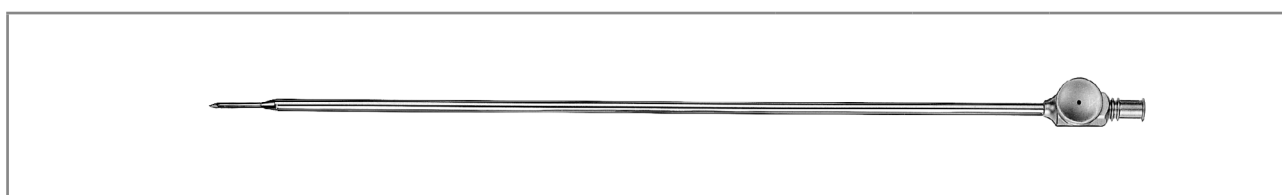

with 3 mm Luer connector		Ø	WL	Product no.
 Tip Ø 1.8 mm	Injection cannula Ø 4.7 mm WL 350 mm	4.7 mm	350 mm	<b>8383.65</b>



with suction regulator and 4 mm Luer connector		Ø	WL	Product no.
 Tip Ø 1.8 mm	Puncture cannula Ø 4.7 mm WL 320 mm	4.7 mm	320 mm	<b>8383.49</b>

for this:		WL	Product no.
	Introduction sleeve size 5.5 mm WL 45 mm  This sleeve prevents damage to the cannula tip when the trocar sleeve valve is opened	45 mm	<b>8383.00</b>

III23 || Subject to modifications. Please note that some products may not be available in all countries. Please always take note of the information that is provided with the product. For more detailed information, please consult with your contact partner or directly with Richard Wolf GmbH.



# SURGICAL PROBES



		Ø	WL	Product no.
	<b>Surgical probe 3.5 mm WL 350 mm graduated</b>	3.5 mm	350 mm	<b>8379.672</b>



		Ø	WL	Product no.
	<b>Surgical probe Ø 5 mm WL 328 mm graduated</b>	5.0 mm	328 mm	<b>8383.66</b>
	<b>Surgical probe Ø 5 mm WL 448 mm graduated</b>	5.0 mm	448 mm	<b>8384.66</b>

11123 || Subject to modifications. Please note that some products may not be available in all countries. Please always take note of the information that is provided with the product. For more detailed information, please consult with your contact partner or directly with Richard Wolf GmbH.

# MYOMA DRILL 5 MM/10 MM



		Ø	WL	Product no.
	Myoma drill Ø 5 mm WL 320 mm	5 mm	320 mm	<b>8383.611</b>
	Myoma drill Ø 10 mm	10 mm	340 mm	<b>8385.301</b>

III23 || Subject to modifications. Please note that some products may not be available in all countries. Please always take note of the information that is provided with the product. For more detailed information, please consult with your contact partner or directly with Richard Wolf GmbH.

# INSUFFLATOR HIGHFLOW 45 BASIC



		Product no.
<b>Insufflator 45 BASIC bndI</b> consisting of: Insufflator 45 BASIC FR 45 l/min (2235001), Insufflation tube set L 2.5 m (8170.101), Hygiene filter, sterile, disposable (PACK= 10 PCS) (4171.111) and power cable 3 m long (2440.03)		<b>22350011</b>
<b>Accessories: Tube sets for insufflation</b>		
Insufflation tube set L 2.5 m, High Flow, D = 8 mm, autoclavable		<b>8170.232</b>
Insufflation tube set L 2.5 m, autoclavable		<b>8170.101</b>
Insufflation tube set L 2.7 m, with integrated hygiene filter, disposable, (PACK= 10 PCS) in individual sterile packaging		<b>4170.501</b>
Hygiene filter, sterile, disposable (PACK= 10 PCS) in individual sterile packaging		<b>4171.111</b>
<b>Accessories for gas supply</b>		
CO <sub>2</sub> connection tube 1.5 m NIST-NIST		<b>74021038</b>
with		
Pressure reducer for CO <sub>2</sub> connector DIN 477-1	DIN 477-1	<b>74007054</b>
Pressure reducer for CO <sub>2</sub> connector DIN EN ISO 407	DIN EN ISO 407	<b>74007055</b>
Pressure reducer for CO <sub>2</sub> connector ISO 5145	ISO 5145	<b>74007056</b>
or		
Connection tube for CO <sub>2</sub> 5.0 m DIN for centralized CO <sub>2</sub> gas supply (Dräger)		<b>74021039</b>
Connection tube for CO <sub>2</sub> 5.0 m NF for centralized CO <sub>2</sub> gas supply (Liquid Air)		<b>74021040</b>
<b>Software modules (optional)</b>		
Software module CAN bus CAN bus interface for integration in CORE		<b>2235101</b>
Software module BABY MODE BABY MODE for special use in pediatrics		<b>2235102</b>
Software module VIDEO DISPLAY: video display using DIALOG via CAN bus		<b>2235103</b>

# TECHNICAL DATA

## INSUFFLATOR HIGHFLOW 45 BASIC

Insufflator 45 BASIC		2235001
<b>Device properties</b>		
Operating mode	Continuous operation	
Operating conditions	+10°C to +40°C, 30% to 75% rel. humidity, atmospheric pressure 700 hPa to 1,060 hPa	
Storage and transport conditions	-20°C to +60°C, 10% to 90% rel. humidity, atmospheric pressure 700 hPa to 1,060 hPa	
<b>Power supply</b>		
Mains + frequency	100–240 V~, 50/60 Hz	
Power consumption	60 VA	
Current rating	0.6–0.2 A	
Fuse	T 3.15 AH 250 V	
<b>Regulatory standards</b>		
Protection class to IEC/EN 60601-1 (UL 60601-1/CSA C222 No6011 – for USA)	I	
Electromagnetic compatibility (EMC)	IEC/EN 60601-1-2	
Medical Devices Directive 93/42/EEC	Class IIb	
Protection against electric shock	Type CF applied part	
Degree of protection against the ingress of liquids	IP 20 (not protected)	
Degree of protection in the presence of flammable mixtures	Device is not protected against explosions (do not operate this device in explosive atmospheres)	
<b>Dimensions and weights</b>		
Weight	8.9 kg (19.5 lbs)	
Dimensions (W x H x D)	300 mm x 160 mm x 455 mm	

Relevant application parameters	
Insufflation medium	Medical-grade CO <sub>2</sub> (degree of purity > 99.5%)
Intraabdominal pressure	3 mmHg to 25 mmHg (± 2 mmHg) selectable in increments of 1 mmHg
Gas flow rate primary filling	1 l/min (± 50%)
Gas flow rate, High Flow	2 l/min to 45 l/min (± 20%) selectable in increments of 1 l/min
Consumption indicator	0 l to 9,999 l (± 20%)

# INSUFFLATOR HIGHFLOW 45 EVAC WITH SMOKE GAS EVACUATION



		Product no.
<b>Insufflator 45 EVAC bndl</b> consisting of: Insufflator 45 EVAC FR 45 l/min (2235011), Insufflation tube set L 2.5 m (8170.101), Hygiene filter, sterile, disposable (PACK= 10 PCS) (4171.111), Insufflation tube set L 2.7 m with integrated hygiene filter, sterile, disposable (PACK= 10 PCS) (4170.501) Smoke gas evacuation tube set L 2.7 m, sterile, disposable (PACK= 10 PCS) (4170503) Footswitch with 1 pedal (20301031) and power cable, 3 m long (2440.03)		<b>22350111</b>
<b>Accessories: Tube sets for insufflation</b>		
Smoke gas evacuation tube set L 2.7 m, sterile, disposable (PACK= 10 PCS)		<b>4170503</b>
<b>Accessories for gas supply</b>		
CO <sub>2</sub> connection tube 1.5 m NIST-NIST		<b>74021038</b>
with		
Pressure reducer for CO <sub>2</sub> connector DIN 477-1	DIN 477-1	<b>74007054</b>
Pressure reducer for CO <sub>2</sub> connector DIN EN ISO 407	DIN EN ISO 407	<b>74007055</b>
Pressure reducer for CO <sub>2</sub> connector ISO 5145	ISO 5145	<b>74007056</b>
or		
Connection tube for CO <sub>2</sub> 5.0 m DIN for centralized CO <sub>2</sub> gas supply (Dräger)		<b>74021039</b>
Connection tube for CO <sub>2</sub> 5.0 m NF for centralized CO <sub>2</sub> gas supply (Liquid Air)		<b>74021040</b>
<b>Software modules (optional)</b>		
Software module CAN bus CAN bus interface for integration in CORE		<b>2235101</b>
Software module BABY MODE BABY MODE for special use in pediatrics		<b>2235102</b>
Software module VIDEO DISPLAY: video display using DIALOG via CAN bus		<b>2235103</b>

# TECHNICAL DATA

## INSUFFLATOR HIGHFLOW 45 EVAC

Insufflator 45 EVAC		2235011
<b>Device properties</b>		
Operating mode	Continuous operation	
Operating conditions	+10°C to +40°C, 30% to 75% rel. humidity, atmospheric pressure 700 hPa to 1,060 hPa	
Storage and transport conditions	-20°C to +60°C, 10% to 90% rel. humidity, atmospheric pressure 700 hPa to 1,060 hPa	
<b>Power supply</b>		
Mains + frequency	100–240 V~, 50/60 Hz	
Power consumption	60 VA	
Current rating	0.6–0.2 A	
Fuse	T 3.15 AH 250 V	
<b>Regulatory standards</b>		
Protection class to IEC/EN 60601-1 (UL 60601-1/CSA C222 No6011 – for USA)	I	
Electromagnetic compatibility (EMC)	IEC/EN 60601-1-2	
Medical Devices Directive 93/42/EEC	Class IIb	
Protection against electric shock	Type CF applied part	
Degree of protection against the ingress of liquids	IP 20 (not protected)	
Degree of protection in the presence of flammable mixtures	Device is not protected against explosions (do not operate this device in explosive atmospheres)	
<b>Dimensions and weights</b>		
Weight	8.9 kg (19.5 lbs)	
Dimensions (W x H x D)	300 mm x 160 mm x 455 mm	

Relevant application parameters	
Insufflation medium	Medical-grade CO <sub>2</sub> (degree of purity > 99.5%)
Intraabdominal pressure	3 mmHg to 25 mmHg (± 2 mmHg) selectable in increments of 1 mmHg
Gas flow rate primary filling	1 l/min (± 50%)
Gas flow rate, High Flow	2 l/min to 45 l/min (± 20%) selectable in increments of 1 l/min
Consumption indicator	0 l to 9,999 l (± 20%)

# INSUFFLATOR HIGHFLOW 45 HEAT WITH GAS HEATING



		Product no.
<b>Insufflator 45 HEAT bndI</b> consisting of: Insufflator 45 HEAT FR 45 L/min(2235021), Insufflation tube for 2235021/031 L 3 m (8170202) Hygiene filter, sterile, disposable (PACK= 10 PCS) (4171.111) and power cable 3 m long (2440.03)		<b>22350211</b>
<b>Accessories: Tube sets for insufflation</b>		
<b>Insufflation tube set L 3 m</b> Highflow, with heating wire and integrated hygiene filter, sterile, disposable, (PACK= 10 PCS) in individual sterile packaging		<b>4170502</b>
<b>Insufflation tube for 2235021/031 L 3 m</b> Highflow, with heating wire, autoclavable, 3.0 m The reusable tube can be used up to 100 times		<b>8170202</b>
<b>Hygiene filter</b> , sterile, disposable (PACK= 10 PCS) in individual sterile packaging		<b>4171.111</b>
<b>Accessories for gas supply</b>		
<b>CO<sub>2</sub> connection tube 1.5 m NIST-NIST</b>		<b>74021038</b>
with		
<b>Pressure reducer for CO<sub>2</sub> connector DIN 477-1</b>	DIN 477-1	<b>74007054</b>
<b>Pressure reducer for CO<sub>2</sub> connector DIN EN ISO 407</b>	DIN EN ISO 407	<b>74007055</b>
<b>Pressure reducer for CO<sub>2</sub> connector ISO 5145</b>	ISO 5145	<b>74007056</b>
or		
<b>Connection tube for CO<sub>2</sub> 5.0 m DIN</b> for centralized CO <sub>2</sub> gas supply (Dräger)		<b>74021039</b>
<b>Connection tube for CO<sub>2</sub> 5.0 m NF</b> for centralized CO <sub>2</sub> gas supply (Liquid Air)		<b>74021040</b>
<b>Software modules (optional)</b>		
<b>Software module CAN bus</b> CAN bus interface for integration in CORE		<b>2235101</b>
<b>Software module BABY MODE</b> BABY MODE for special use in pediatrics		<b>2235102</b>
<b>Software module VIDEO DISPLAY:</b> video display using DIALOG via CAN bus		<b>2235103</b>

# TECHNICAL DATA

## INSUFFLATOR HIGHFLOW 45 HEAT

Insufflator 45 HEAT		2235021
<b>Device properties</b>		
Operating mode	Continuous operation	
Operating conditions	+10°C to +40°C, 30% to 75% rel. humidity, atmospheric pressure 700 hPa to 1,060 hPa	
Storage and transport conditions	-20°C to +60°C, 10% to 90% rel. humidity, atmospheric pressure 700 hPa to 1,060 hPa	
<b>Power supply</b>		
Mains + frequency	100–127/220–240 V~, 50/60 Hz	
Power consumption	80 VA	
Current rating	0.8–0.3 A	
Fuse	T 3.15 AH 250 V	
<b>Regulatory standards</b>		
Protection class to IEC/EN 60601-1 (UL 60601-1/CSA C222 No6011 – for USA)	I	
Electromagnetic compatibility (EMC)	IEC/EN 60601-1-2	
Medical Devices Directive 93/42/EEC	Class IIb	
Protection against electric shock	Type CF applied part	
Degree of protection against the ingress of liquids	IP 20 (not protected)	
Degree of protection in the presence of flammable mixtures	Device is not protected against explosions (do not operate this device in explosive atmospheres)	
<b>Dimensions and weights</b>		
Weight	11.0 kg (23.3 lbs)	
Dimensions (W x H x D)	300 mm x 160 mm x 455 mm	
<b>Relevant application parameters</b>		
Insufflation medium	Medical-grade CO <sub>2</sub> (degree of purity > 99.5%)	
Intraabdominal pressure	3 mmHg to 25 mmHg (± 2 mmHg) selectable in increments of 1 mmHg	
Gas flow rate primary filling	1 l/min (± 50%)	
Gas flow rate, High Flow	2 l/min to 45 l/min (± 20%) selectable in increments of 1 l/min	
Consumption indicator	0 l to 9,999 l (± 20%)	



# INSUFFLATOR HIGHFLOW 45 EVAC + HEAT

## WITH SMOKE GAS EVACUATION AND GAS HEATING



		Product no.
<b>Insufflator 45 EVAC + HEAT bndl</b>		
consisting of: Insufflator 45 EVAC + HEAT FR 45 l/min(2235031), Insufflation tube for 2235021/031 L 3 m (8170202), Insufflation tube set L 3 m, sterile, disposable, (PACK= 10 PCS) (4170502), Hygiene filter, sterile, disposable (PACK= 10 PCS) (4171.111), Smoke gas evacuation tube set L 2.7 m, sterile, disposable (PACK= 10 PCS) (4170503) Footswitch 1 pedal (20301031) and power cable 3 m long (2440.03)		<b>22350311</b>
<b>Accessories: Tube sets for insufflation</b>		
<b>Insufflation tube set L 3 m</b> Highflow, with heating wire and integrated hygiene filter, sterile, disposable, (PACK= 10 PCS) in individual sterile packaging		<b>4170502</b>
<b>Insufflation tube for 2235021/031 L 3 m</b> Highflow, with heating wire, autoclavable, 3.0 m <small>The reusable tube can be used up to 100 times</small>		<b>8170202</b>
<b>Hygiene filter</b> , sterile, disposable (PACK= 10 PCS) in individual sterile packaging		<b>4171.111</b>
<b>Smoke gas evacuation tube set L 2.7 m</b> , sterile, disposable (PACK= 10 PCS)		<b>4170503</b>
<b>Accessories for gas supply</b>		
<b>CO<sub>2</sub> connection tube 1.5 m NIST-NIST</b>		<b>74021038</b>
with		
<b>Pressure reducer for CO<sub>2</sub> connector DIN 477-1</b>	DIN 477-1	<b>74007054</b>
<b>Pressure reducer for CO<sub>2</sub> connector DIN EN ISO 407</b>	DIN EN ISO 407	<b>74007055</b>
<b>Pressure reducer for CO<sub>2</sub> connector ISO 5145</b>	ISO 5145	<b>74007056</b>
or		
<b>Connection tube for CO<sub>2</sub> 5.0 m DIN</b> for centralized CO <sub>2</sub> gas supply (Dräger)		<b>74021039</b>
<b>Connection tube for CO<sub>2</sub> 5.0 m NF</b> for centralized CO <sub>2</sub> gas supply (Liquid Air)		<b>74021040</b>
<b>Software modules (optional)</b>		
<b>Software module CAN bus</b> CAN bus interface for integration in CORE		<b>2235101</b>
<b>Software module BABY MODE</b> BABY MODE for special use in pediatrics		<b>2235102</b>
<b>Software module VIDEO DISPLAY:</b> video display using DIALOG via CAN bus		<b>2235103</b>

# TECHNICAL DATA

## INSUFFLATOR HIGHFLOW 45 EVAC + HEAT

Insufflator 45 EVAC + HEAT		2235031
<b>Device properties</b>		
Operating mode	Continuous operation	
Operating conditions	+10°C to +40°C, 30% to 75% rel. humidity, atmospheric pressure 700 hPa to 1,060 hPa	
Storage and transport conditions	-20°C to +60°C, 10% to 90% rel. humidity, atmospheric pressure 700 hPa to 1,060 hPa	
<b>Power supply</b>		
Mains + frequency	100–127/220–240 V~, 50/60 Hz	
Power consumption	80 VA	
Current rating	0.8–0.3 A	
Fuse	T 3.15 AH 250 V	
<b>Regulatory standards</b>		
Protection class to IEC/EN 60601-1 (UL 60601-1/CSA C222 No6011 – for USA)	I	
Electromagnetic compatibility (EMC)	IEC/EN 60601-1-2	
Medical Devices Directive 93/42/EEC	Class IIb	
Protection against electric shock	Type CF applied part	
Degree of protection against the ingress of liquids	IP 20 (not protected)	
Degree of protection in the presence of flammable mixtures	Device is not protected against explosions (do not operate this device in explosive atmospheres)	
<b>Dimensions and weights</b>		
Weight	11.0 kg (23.3 lbs)	
Dimensions (W x H x D)	300 x 160 x 455 mm	

Relevant application parameters	
Insufflation medium	Medical-grade CO <sub>2</sub> (degree of purity > 99.5%)
Intraabdominal pressure	3 mmHg to 25 mmHg (± 2 mmHg) selectable in increments of 1 mmHg
Gas flow rate primary filling	1 l/min (± 50%)
Gas flow rate, High Flow	2 l/min to 45 l/min (± 20%) selectable in increments of 1 l/min
Consumption indicator	0 l to 9,999 l (± 20%)

# LAPARO-CO<sub>2</sub>-PNEU 2233



		Product no.
<b>LAPARO-CO<sub>2</sub>-PNEU bndl</b> consisting of: LAPARO-CO2-PNEU 2233 FR 20 L/MIN (2233.001) Insufflation tube set L 2.5 m (8170.101), Hygiene filter, sterile, disposable (PACK= 10 PCS) (4171.111), and power cable 3 m long (2440.03)		<b>22330011</b>
<b>Accessories: Tube sets for insufflation</b>		
<b>Insufflation tube set, L 2.7 m</b> with integrated hygiene filter, sterile, disposable, (PACK= 10 PCS) in individual sterile packaging		<b>4170.501</b>
<b>Accessories for gas supply</b>		
<b>CO<sub>2</sub> connection tube 1.5 m NIST-NIST</b>		<b>74021038</b>
with		
<b>Pressure reducer for CO<sub>2</sub> connector DIN 477-1</b>	DIN 477-1	<b>74007054</b>
<b>Pressure reducer for CO<sub>2</sub> connector DIN EN ISO 407</b>	DIN EN ISO 407	<b>74007055</b>
<b>Pressure reducer for CO<sub>2</sub> connector ISO 5145</b>	ISO 5145	<b>74007056</b>
or		
<b>Connection tube for CO<sub>2</sub> 5.0 m DIN for centralized CO<sub>2</sub> gas supply (Dräger)</b>		<b>74021039</b>
<b>Connection tube for CO<sub>2</sub> 5.0 m NF for centralized CO<sub>2</sub> gas supply (Liquid Air)</b>		<b>74021040</b>

11123 || Subject to modifications. Please note that some products may not be available in all countries. Please always take note of the information that is provided with the product. For more detailed information, please consult with your contact partner or directly with Richard Wolf GmbH.



# TECHNICAL DATA

## LAPARO-CO<sub>2</sub>-PNEU 2233

LAPARO-CO <sub>2</sub> -PNEU 2233		2233.001
<b>Device properties</b>		
Operating mode	Continuous operation	
Operating conditions	+10°C to +40°C, 30% to 75% rel. humidity, atmospheric pressure 700 hPa to 1,060 hPa	
Storage and transport conditions	-20°C to +60°C, 10% to 90% rel. humidity, atmospheric pressure 700 hPa to 1,060 hPa	
<b>Power supply</b>		
Mains + frequency	100–230 V~, 50/60 Hz	
Power consumption	80 VA	
Current rating	0.8 A	
Fuse	T 2 AL 250 V	
<b>Regulatory standards</b>		
Protection class to IEC/EN 60601-1 (UL 60601-1/CSA C222 No6011 – for USA)	I	
Electromagnetic compatibility (EMC)	EN/IEC 60601--1--2	
Medical Devices Directive 93/42/EEC	Class IIb	
Protection against electric shock	Type CF applied part	
Degree of protection against the ingress of liquids	IP 20 (not protected)	
Degree of protection in the presence of flammable mixtures	Device is not protected against explosions (do not operate this device in explosive atmospheres)	
Maximum suction vacuum	-60 kPa	
<b>Dimensions and weights</b>		
Weight	9.5 kg	
Dimensions (W x H x D)	330 mm x 155 mm x 390 mm	

Relevant application parameters	
Insufflation medium	Medical-grade CO <sub>2</sub> (degree of purity > 99.5%)
Intraabdominal pressure	3 mmHg to 25 mmHg (± 2 mmHg) selectable in increments of 1 mmHg
Gas flow rate primary filling	1 l/min (± 50%)
Gas flow rate, High Flow	2 l/min to 20 l/min (± 20%) selectable in increments of 1 l/min
Consumption indicator	0 l to 9,999 l (± 20%)

# STERILE SMOKE GAS EVACUATION FILTER FOR SMOKE GAS DISCHARGE

 	
<b>Product no.</b>	
<p><b>Smoke gas evacuation filter</b> (PACK= 10 PCS) in individual sterile packaging</p>	<p><b>4170504</b></p>

III23 || Subject to modifications. Please note that some products may not be available in all countries. Please always take note of the information that is provided with the product. For more detailed information, please consult with your contact partner or directly with Richard Wolf GmbH.

# FLUID CONTROL 2225

## SUCTION IRRIGATION PUMP

core



		Product no.
FLUID CONTROL 2225 <b>Irrigation pump for Hys/Uro/Lap bndl</b> consisting of: Irrigation pump for Hys/Uro/Lap (2225001) and power cable 3 m long (2440.03)		<b>22250011</b>
<b>for this:</b>		
<b>Balancing module</b> for hysteroscopy and endourology, fluid management for fluid balancing in combination with FLUID CONTROL 2225, mobile stand with integrated weighing cells and space for up to 4 irrigation fluid bags		<b>2225023</b>

Accessories		Product no.
<b>Footswitch</b>	only for use in urology and within the indication TUR/enucleation, possibility of short-term increase in pressure if visibility is poor (Flush function)	<b>2204901</b>

III23 || Subject to modifications. Please note that some products may not be available in all countries. Please always take note of the information that is provided with the product. For more detailed information, please consult with your contact partner or directly with Richard Wolf GmbH.

# FLUID CONTROL 2225

## SUCTION IRRIGATION TUBE SETS

Irrigation			Product no.
<b>Accessories – reusable</b>	<b>Tube set with piercing spike</b>	with Luer-Lock connection, autoclavable, incl. 10 spare membranes, reusable for 20 reprocessing cycles	<b>8171223</b>
<b>Accessories – disposable</b>	<b>Irrigation tube set with piercing spike, L 3 m</b>	(PACK= 10 PCS), with Luer-Lock connection, sterile, disposable product	<b>4171223</b>
	<b>Tube set with CARE-LOCK, L 3 m</b>	(PACK= 10 PCS), sterile, disposable product	<b>4171224</b>
	<b>Suction irrigation tube set</b>	(PACK= 10 PCS), with piercing spike, sterile disposable product, PVC	<b>4171225</b>
	<b>Day irrigation tube set</b>	(PACK= 10 PCS), sterile, disposable product, PVC	<b>4171226</b>
	<b>Patient irrigation tube set, sterile</b>	(PACK= 10 PCS), with Luer-Lock connection, sterile, disposable product, PVC	<b>4171227</b>
<i>Note: Day tube and patient tube can only be used together. A new patient tube is required for each patient; the day tube can be used for up to 20 patients</i>			

Suction			Product no.
<b>Accessories – reusable</b>	<b>Tube set for vacuum, incl. filter</b>	with integrated hygiene filter, PACK= 10 PCS, service life: 30 days (connected to irrigation pump)	<b>2206207</b>
	<b>Irrigation tube</b>	L 1.2 m, with Luer-Lock, for suction irrigation handle 8385.901 and tube set 8171223 or 8170.223	<b>817123</b>
	<b>Suction tube L 3 m</b>	for suction irrigation handle 8385.901	<b>8171402</b>
	<b>Secretion container, 2 l</b>	2 liters, with lid	<b>8170.655</b>
	<b>Secretion container, 2 l</b>	2 liters, no lid	<b>8170.6551</b>
<b>Accessories – disposable</b>	<b>Secretion container, 2.5 l</b>	2.5 liters (PACK= 2 PCS)	<b>41706566</b>
	<b>Secretion container bndl consisting of:</b>	Secretion container 2.5 l (41706566) and secretion bag (PACK= 90 PCS) (41706564)	<b>4170657</b>
	<b>Tube set for suction (2 connections)</b>	sterile, disposable product, (PACK= 10 PCS) for connecting instruments to collecting container	<b>T0503-01</b>
	<b>Angled 90° plug-in coupling</b>	(PACK= 10 PCS) For connecting vacuum tube 2206207 to disposable container systems	<b>0771019</b>

# FLUID CONTROL 2225

## CABLE ACCESSORIES

		Product no.
Patch cable, RJ45 SFTP, 0.5 m	Cable length 0.5 m	<b>72325378</b>
Patch cable, RJ45 HRS TM11, 1.0 m	Cable length 1.0 m	<b>72325429</b>
Patch cable, RJ45 S/FTP CAT6 10 m	Cable length 10 m	<b>72325434</b>
Plastic caps for network socket	(PACK= 8 PCS)	<b>5592105</b>
Power cable	Cable length 3 m	<b>2440.03</b>

III23 || Subject to modifications. Please note that some products may not be available in all countries. Please always take note of the information that is provided with the product. For more detailed information, please consult with your contact partner or directly with Richard Wolf GmbH.



# TECHNICAL DATA

## FLUID CONTROL 2225

FLUID CONTROL 2225		2225001
<b>Device properties</b>		
Operating conditions		+10°C to +40°C, 30% to 75% rel. humidity, 70 to 106 kPa atmospheric pressure 3,000 m max. altitude above sea level
Storage and transport conditions		-20°C to +60°C, 10% to 90% rel. humidity 70 to 106 kPa atmospheric pressure
<b>Power supply</b>		
Mains + frequency		100–240 V~, 50/60 Hz
Power consumption	100 V/60 Hz	110 VA
	240 V/50 Hz	120 VA
Current rating	100 V/60 Hz	1.10 A
	240 V/50 Hz	0.50 A
Fuse		T 3.15 AH, 250 V
<b>Regulatory standards</b>		
Protection class (I, II)		I
Electromagnetic compatibility (EMC)		EN 60601-1/IEC 60601-1 EN 60601-1-2/IEC 60601-1-2
Medical Devices Directive 93/42/EEC		Class IIb
Housing protection rating (IP code)		IP21
Protection against electric shock		Type BF applied part
Degree of protection in the presence of flammable mixtures		Device is not protected against explosions (do not operate this device in explosive atmospheres)
Maximum suction vacuum		-60 kPa
<b>Dimensions and weights</b>		
Weight		8.8 kg
Dimensions (W x H x D)		300 mm x 157 mm x 436 mm
<b>Relevant application parameters</b>		
Nominal flow range		Hysteroscopy: 800 ml/min (max. flow, not adjustable) Endourology: 10–800 ml/min (max. flow) Laparoscopy: 0.1–1.8 l/min (max. flow)
Suction power		max. 2 l/min
Starting nominal pressure range		Hysteroscopy: 15–200 mmHg Endourology: 15–90 mmHg/20–120 cmH2O Laparoscopy: 300 mmHg (not adjustable)
Pressure		0–300 mmHg
Deficit		-9,990 to +9,990 ml/0 to 99.9 l

# TECHNICAL DATA

## FLUID CONTROL 2225

<b>Balancing module</b>		<b>2225023</b>
<b>Device properties</b>		
Operating conditions	+10°C to +40°C, 30% to 75% rel. humidity, 70 to 106 kPa atmospheric pressure 3,000 m max. altitude above sea level	
Storage and transport conditions	-20°C to +60°C , 10% to 90% rel. humidity 70 to 106 kPa atmospheric pressure	
<b>Regulatory standards</b>		
Electromagnetic compatibility (EMC)	EN 60601-1/IEC 60601-1 EN 60601-1-2/IEC 60601-1-2	
Housing protection rating (IP code)	IP21	
Maximum load of container scale	16 kg/4 containers of 3 l each	
Maximum load of bag scale	23 kg/4 bags of 5 l each	
<b>Dimensions and weights</b>		
Weight	15.4 kg	
Dimensions (W x H x D)	618 mm x 1,064 mm x 618 mm	

<b>Footswitch</b>		<b>2204901</b>
<b>Power supply</b>		
Power supply connection	max. 24 V	
Power consumption	max. 0.1 A	
<b>Regulatory standards</b>		
Electromagnetic compatibility (EMC)	EN 60601-1/IEC 60601-1	
Housing protection rating (IP code)	IPX8	
Plug	7-pin circular connector	
Cable length	4.5 m	
<b>Dimensions and weights</b>		
Weight	300 g	
Dimensions (W x H x D)	66 mm x 27 mm x 91 mm	

# FLUID CONTROL LAP 2216

	
<b>Product no.</b>	
<p>FLUID CONTROL  <b>LAP suction irrigation pump bndl</b>                  consisting of:                  LAP suction irrigation pump (2216001)                  and power cable 3 m long (2440.03)</p>	<b>22160011</b>

Accessories		Product no.
<b>Bracket</b>	for fixing the suction container on the irrigator stand or MUT cart	<b>2215.992</b>
<b>Universal holder</b>	for FLUID CONTROL LAP on RIWomobil	<b>32114605</b>

11123 | Subject to modifications. Please note that some products may not be available in all countries. Please always take note of the information that is provided with the product. For more detailed information, please consult with your contact partner or directly with Richard Wolf GmbH.

# LAP SUCTION IRRIGATION PUMP 2216

## SUCTION IRRIGATION TUBE SETS

Irrigation			Product no.
Accessories – reusable	Tube set with piercing spike	with Luer-Lock connection, autoclavable, incl. 10 spare membranes, reusable for 20 reprocessing cycles	<b>8171223</b>
	Irrigation tube set with piercing spike, L 3 m	(PACK= 10 PCS), with Luer-Lock connection, sterile, disposable product	<b>4171223</b>
Accessories – disposable	Tube set with CARE-LOCK, L 3 m	(PACK= 10 PCS), sterile, disposable product	<b>4171224</b>
	Suction irrigation tube set	(PACK= 10 PCS), with piercing spike, sterile disposable product, PVC	<b>4171225</b>
	Day irrigation tube set	(PACK= 10 PCS), sterile, disposable product, PVC	<b>4171226</b>
	Patient irrigation tube set, sterile	(PACK= 10 PCS), with Luer-Lock connection, sterile, disposable product, PVC	<b>4171227</b>
<i>Note: Day tube and patient tube can only be used together. A new patient tube is required for each patient; the day tube can be used for up to 20 patients</i>			

Suction			Product no.
Accessories – reusable	Tube set for vacuum, incl. filter	with integrated hygiene filter, PACK= 10 PCS, service life: 30 days (connected to irrigation pump)	<b>2206207</b>
	Irrigation tube	L 1.2 m, with Luer-Lock, for suction irrigation handle 8385.901 and tube set 8171223 or 8170.223	<b>817123</b>
	Suction tube L 3 m	for suction irrigation handle 8385.901	<b>8171402</b>
	Secretion container, 2 l	2 liters, with lid	<b>8170.655</b>
	Secretion container, 2 l	2 liters, no lid	<b>8170.6551</b>
Accessories – disposable	Secretion container, 2.5 l	2.5 liters (PACK= 2 PCS)	<b>41706566</b>
	Secretion container bndl consisting of:	Secretion container 2.5 l (41706566) and secretion bag (PACK= 90 PCS) (41706564)	<b>4170657</b>
	Tube set for suction (2 connections)	sterile, disposable product, (PACK= 10 PCS) for connecting instruments to collecting container	<b>T0503-01</b>
	Angled 90° plug-in coupling	(PACK= 10 PCS) For connecting vacuum tube 2206207 to disposable container systems	<b>0771019</b>

# TECHNICAL DATA

## FLUID CONTROL LAP 2216

LAP suction irrigation pump		2216001
<b>Device properties</b>		
Operating conditions	+10°C to +40°C, 30% to 75% rel. humidity, atmospheric pressure 700 hPa to 1,060 hPa 3,000 m max. altitude above sea level	
Storage conditions	+5°C to +40°C, 5% to 90% rel. humidity, atmospheric pressure 700 hPa to 1,060 hPa	
Transport and shipping conditions	-20°C to +60°C, 5% to 90% rel. humidity, atmospheric pressure 700 hPa to 1,060 hPa	
<b>Power supply</b>		
Mains + frequency	100–240 V~, 50/60 Hz	
Power consumption	100 V/60 Hz	65 VA
	240 V/50 Hz	96 VA
Current rating	100 V/60 Hz	0.65 A
	240 V/50 Hz	0.42 A
Protection class	I	
Electromagnetic compatibility (EMC)	IEC 60601-1/EN 60601-1 IEC 60601-1-2/EN 60601-1-2	
Medical Devices Directive 93/42/EEC	Class IIa	
Protection against electric shock	Type BF applied part	
Degree of protection against the ingress of liquids	IP 41	
Degree of protection in the presence of flammable mixtures	Device is not protected against explosions (do not operate this device in explosive atmospheres)	
<b>Dimensions and weights</b>		
Weight	4 kg	
Dimensions (W x H x D) with toggle screw	140 mm x 210 mm x 295 mm	

Relevant application parameters	
Maximum delivery rate	Rinsing: 2.0 l/min ( $\pm$ 10%), suction: 2.0 l/min (+0.4/-0.1 l/min)
Maximum pump pressure	400 mmHg ( $\pm$ 50 mmHg)
Motor cut-out	500 mmHg after 5 s ( $\pm$ 25 mmHg)
Suction pressure	between -50 kPa and -60 kPa
Connections	Equipotential bonding, vacuum connection

# HF GENERATOR 2260

core

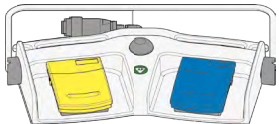

		Product no.
HF surgical generator 400 kHz	for the connection of monopolar and bipolar accessories, international version (BOWA, KLS Martin, Olympus, Karl Storz, Valleylab)	2260001
HF surgical generator 400 kHz	for the connection of monopolar and bipolar accessories, E version (Erbe)	2260002

Accessories required	Cable length	Product no.
<b>Footswitch, 2 pedals L 5 m</b> with fixed connection cable, reusable 		2260021
<b>Neutral electrode</b> for use with high-frequency surgical device, Foil bag with 5 neutral electrodes, (PACK= 50 PCS)		1280H
<b>Mono HF neutral electrode cable, L 4.5 m</b>	4.5 m	2260031
<b>Power cable</b>	3.0 m	2440.03
<b>Bipo HF connection cable L 3 m</b>	3.0 m	8108233
<b>Bipo HF connection cable L 5 m</b>	5.0 m	8108253







11123 || Subject to modifications. Please note that some products may not be available in all countries. Please always take note of the information that is provided with the product. For more detailed information, please consult with your contact partner or directly with Richard Wolf GmbH.

# HF GENERATOR 2260

## TECHNICAL DATA

HF surgical generator 400kHz		2260001/2260002
<b>Device properties</b>		
Type of controls on housing front		Touch panel
Output power	max.cutting power	400 W
	max.coagulation power	350 W
LF and HF leakage currents		acc. to DIN EN 60601 1 and DIN EN 60601 2 2
Signal level		HF indicator 55 dB(A); adjustable 45–60 dB(A) Alarm 65 dB(A)
Operating conditions		+10°C to +40°C, 30% to 75% rel humidity, 700 hPa to 1,060 hPa atmospheric pressure
Storage and transport conditions		- 20°C to + 60°C, 10% to 90% rel humidity, 700 hPa to 1,060 hPa atmospheric pressure
<b>Power supply</b>		
Mains + frequency		100–240 V~, 50/60 Hz
Power consumption	without HF output	45 VA
	at max. output power	650 VA
Current rating		max. 6.3 A
Fuse		T 6.3 AH 250 V
<b>Regulatory standards</b>		
Protection class to EN/IEC 60601-1 (UL 2601-1/CSA C222 No6011 – for USA)		I
Electromagnetic compatibility (EMC)		EN/IEC 60601-1-2
Medical Devices Directive 93/42/EEC		Class IIb
Degree of protection against the ingress of liquids (DIN EN/IEC 60529)		IPX0
Degree of protection against the ingress of solids		IP2X
Duty factor (duty cycle DC)		Intermittent INT 10 s/30 s corresponding to 25% DC
Protection against electric shock		Model CF applied part, defibrillator-proof
Degree of protection in the presence of flammable mixtures		Device is not protected against explosions (do not operate this device in explosive atmospheres)
<b>Dimensions and weights</b>		
Weight		10.2 kg (22.4 lbs)
Dimensions (W x H x D)		300 x 159 x 419 mm

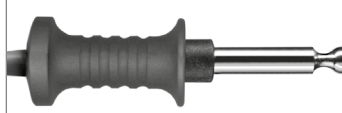
# HF CONNECTION CABLE MONO 815xxx

Instrument connector	Device connector		Product no.
<b>WOLF Resectoscopes</b> 	 ERBE (ACC/ICC/IO)/BOWA (EU) R. Wolf HF surgical generator 400 kHz 2260002	HF connection cable mono L 3 m	<b>815.032</b>
		HF connection cable mono L 5 m	<b>815.052</b>
	 ERBE (T series)	HF connection cable mono L 3 m	<b>815.132</b>
		HF connection cable mono L 5 m	<b>815.152</b>
<b>HF electrodes, monopolar</b> 	 Martin (M-version)/Berchtold/ Aesculap	HF connection cable mono L 3 m	<b>815.031</b>
		HF connection cable mono L 5 m	<b>815.051</b>
	 Bovie/Valleylab/Erbe (Int.)/ BOWA (Int.) R. Wolf HF surgical generator 400 kHz 2260001	HF connection cable mono L 3 m	<b>815.033</b>
		HF connection cable mono L 5 m	<b>815.053</b>
	 BOWA (Int./EU) Eschmann and other devices with 4 mm plugs R. Wolf HF surgical generator 400 kHz 2260001	HF connection cable mono L 3 m	<b>815.034</b>
		HF connection cable mono L 5 m	<b>815.054</b>

III23 || Subject to modifications. Please note that some products may not be available in all countries. Please always take note of the information that is provided with the product. For more detailed information, please consult with your contact partner or directly with Richard Wolf GmbH.











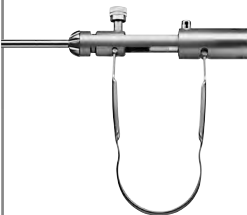

# HF CONNECTION CABLE MONO 8106xxx

Instrument connector	Device connector		Product no.
<b>WOLF Instruments/surgical generator</b> 		HF connection cable mono L 3 m	<b>8106.032</b>
	Erbe (ACC/ICC/VIO)/BOWA (EU) R. Wolf HF surgical generator 400 kHz 2260002	HF connection cable mono L 5 m	<b>8106.052</b>
		HF connection cable mono L 3 m	<b>8106.132</b>
	Erbe (T series)	HF connection cable mono L 5 m	<b>8106.152</b>
<b>HF electrodes, monopolar</b> 		HF connection cable mono L 3 m	<b>8106.031</b>
	Martin (M-version)/Berchold/ Aesculap	HF connection cable mono L 5 m	<b>8106.051</b>
		HF connection cable mono L 3 m	<b>8106.033</b>
	Bovie/Valleylab/Erbe (Int.)/ BOWA (Int.) R. Wolf HF surgical generator 400 kHz 2260001	HF connection cable mono L 5 m	<b>8106.053</b>
		HF connection cable mono L 3 m	<b>8106.034</b>
	BOWA (Int./EU) Eschmann and other devices with 4 mm plugs R. Wolf HF surgical generator 400 kHz 2260001/2260002	HF connection cable mono L 5 m	<b>8106.054</b>





# BIPO HF CONNECTION CABLE

8108xxx

Instrument connector	Device connector		Product no.	
<p><b>WOLF Bipolar forceps</b></p> 	 <p>ERBE (ACC/ICC/T)/BOWA (EU) R. Wolf HF surgical generator 400 kHz 2260001/2260002</p>	<p>HF connection cable bipo; L 3 m</p>	<b>8108.032</b>	
		<p>HF connection cable bipo; L 5 m</p>	<b>8108.052</b>	
	 <p>International / 2-pin Valleylab R. Wolf HF surgical generator 400 kHz 2260001/2260002</p>	<p>HF connection cable bipo; L 3 m</p>	<b>8108.033</b>	
		<p>HF connection cable bipo; L 5 m</p>	<b>8108.053</b>	
	 <p>WOLF/Martin (M-version)/ Berchtold/Aesculap</p>	<p>HF connection cable bipo; L 3 m</p>	<b>8108.031</b>	
		<p>HF connection cable bipo; L 5 m</p>	<b>8108.051</b>	
	 <p>EMC Dolley</p>	<p>HF connection cable bipo; L 3 m</p>	<b>8108035</b>	
	<p><b>Bipolar tweezers connection</b></p> 	 <p>ERBE (ACC/ICC/T)/BOWA (EU) R. Wolf HF surgical generator 400 kHz 2260001/2260002</p>	<p>HF connection cable bipo; L 3 m</p>	<b>8108.132</b>
			<p>HF connection cable bipo; L 5 m</p>	<b>8108.152</b>
		 <p>International / 2-pin Valleylab R. Wolf HF surgical generator 400 kHz 2260001/2260002</p>	<p>HF connection cable bipo; L 3 m</p>	<b>8108.133</b>
		<p>HF connection cable bipo; L 5 m</p>	<b>8108.153</b>	
 <p>Martin (M-version)/Berchtold/ Aesculap</p>		<p>HF connection cable bipo; L 3 m</p>	<b>8108.131</b>	
		<p>HF connection cable bipo; L 5 m</p>	<b>8108.151</b>	
 <p>EMC Dolley</p>		<p>HF connection cable bipo; L 3 m</p>	<b>8108135</b>	

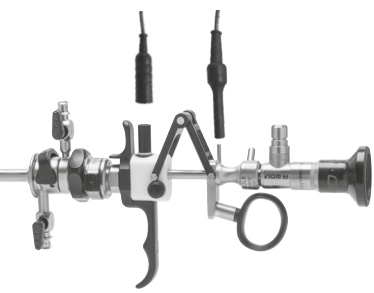

III23 || Subject to modifications. Please note that some products may not be available in all countries. Please always take note of the information that is provided with the product. For more detailed information, please consult with your contact partner or directly with Richard Wolf GmbH.

# HF CONNECTION CABLE BIPO FOR RESECTION IN SALINE SOLUTION

Instrument connector	Device connector		Product no.
<p><b>WOLF S(a)line resectoscopes</b></p> 	 Erbe VIO 300D	<p><b>Bipolar cable; TUR/TCR; WOLF</b> MF plug; L 4 m</p>	<p><b>20196-119</b></p>
	 Erbe VIO 3	<p><b>BIPOLAR CABLE; MF-U</b> MF plug; L 4.5 m</p>	<p><b>21196-119</b></p>
	 KLS Martin	<p><b>HF connection cable bipo; L 3 m</b></p>	<p><b>8108.231</b></p>
		<p><b>HF connection cable bipo; L 5 m</b></p>	<p><b>8108.251</b></p>
	 R. Wolf HF surgical generator 400 kHz 2260001/2260002		
		<p><b>HF connection cable bipo; L 5 m</b></p>	<p><b>8108233</b></p>

11123 || Subject to modifications. Please note that some products may not be available in all countries. Please always take note of the information that is provided with the product. For more detailed information, please consult with your contact partner or directly with Richard Wolf GmbH.

# MONO HF NEUTRAL ELECTRODE CABLE

Instrument connector	Device connector		Product no.
<p><b>2-pole neutral electrode</b></p> 	 <p>R. Wolf HF surgical generator 400 kHz 2260001/2260002</p>	<p><b>Mono HF neutral electrode cable, L 4.5 m</b></p>	<p><b>2260031</b></p>

III23 || Subject to modifications. Please note that some products may not be available in all countries. Please always take note of the information that is provided with the product. For more detailed information, please consult with your contact partner or directly with Richard Wolf GmbH.

# FLEXIBLE FIBER CHOLEDOCHOSCOPE 5 MM CHANNEL 2.5 MM

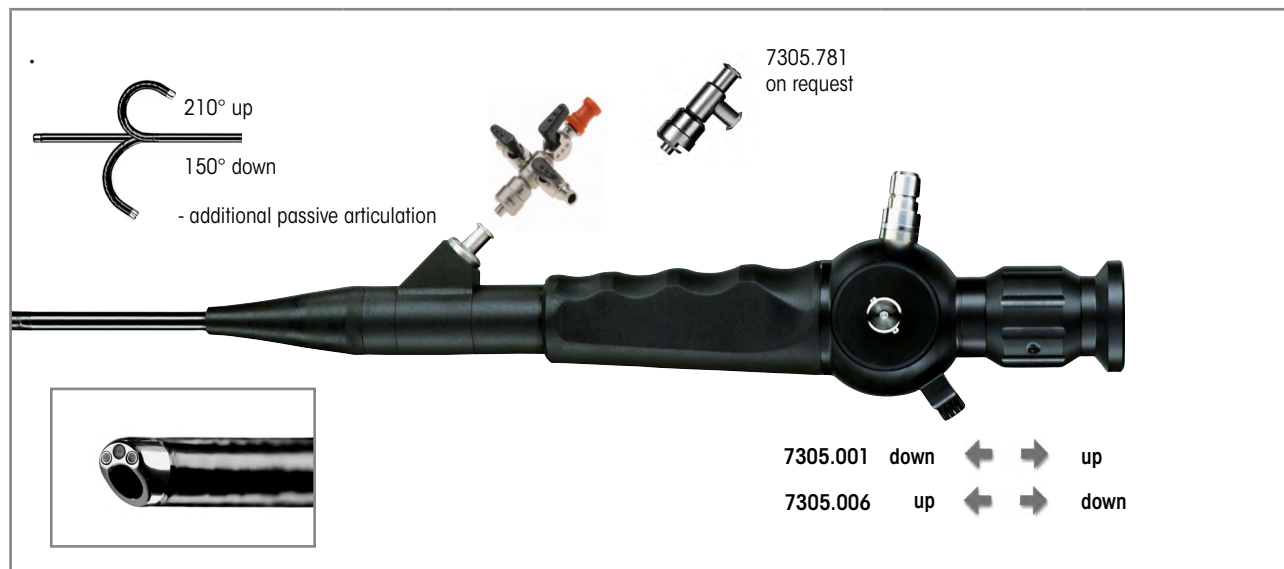

	Outer Ø	Working channel	WL	Control lever in distal direction – articulation downward	Control lever in distal direction – articulation upward	Product no.
<b>Fiber cystoscope 15 FR WL 400 mm</b>	5 mm 15 Fr	25 mm 75 Fr	400 mm	•		<b>7305.001</b>
Slanted distal tip Articulation +210°/-150° Direction of view 0°, viewing angle 110°				•	<b>7305.006</b>	
<b>Fiber cystoscope bndl</b> consisting of: Fiber cystoscope 15 FR WL 400 mm (7305.001) Adapter with 2 irrigation valves and 1 instrument port (7305.782) Leakage tester for flex. endoscopes (163.903) Pressure equalization valve (163.904) Cleaning brush Ø 3 mm, TL 1,200 mm (PACK= 10 PCS) (7990002)				•		<b>730500111</b>
<b>Fiber cystoscope bndl</b> consisting of: Fiber cystoscope 15 FR WL 400 mm (7305.006) Adapter with 2 irrigation valves and 1 instrument port (7305.782) Leakage tester for flex. endoscopes (163.903) Pressure equalization valve (163.904) Cleaning brush Ø 3 mm, TL 1,200 mm (PACK= 10 PCS) (7990002)					•	<b>730500611</b>

Recommended accessories	Product no.
<b>Fiber light cable bndl</b> consisting of: Fiber light cable Ø 2.5 mm TL 2.3 m (80662523), projector-side adapter (8095.07), and endoscope-side adapter (809509)	Ø 2.5 mm, 2.3 m long <b>806625231</b>

11123 | Subject to modifications. Please note that some products may not be available in all countries. Please always take note of the information that is provided with the product. For more detailed information, please consult with your contact partner or directly with Richard Wolf GmbH.

**mamba**  
VISION

**FLEXIBLE SENSOR ENDOSCOPE FOR USE IN CHOLEDOCHOSCOPY**

FOR ENDOCAM **Logic 4K** CONTROLLER



	Outer Ø	Working channel	WL	Control lever in distal direction – articulation downward	Control lever in distal direction – articulation upward	Product no.
<b>Sensor cystoscope</b> <b>16.2 Fr WL 400 mm</b> Slanted distal tip Articulation +210°/-210° Direction of view 0°, viewing angle 120°	16.2 Fr	2.5 mm 7.5 Fr	400 mm	•		<b>7315001</b>
				•	<b>7315006</b>	
<b>Sensor cystoscope bndl</b> consisting of: Sensor cystoscope 16.2 FR, WL 400 mm (7315001) Leakage tester for flex. endoscopes (163.903), pressure equalization valve (163.904), Luer sealing cap (15023205), and cleaning brush Ø 5 mm, TL 1,200 mm (PACK= 10 PCS) (7990005)				•		<b>73150012</b>
<b>Sensor cystoscope bndl</b> consisting of: Sensor cystoscope 16.2 FR, WL 400 mm (7315006) Leakage tester for flex. endoscopes (163.903), pressure equalization valve (163.904), Luer sealing cap (15023205), and cleaning brush Ø 5 mm, TL 1200 mm (PACK= 10 PCS) (7990005)					•	<b>73150062</b>
<b>Recommended accessories</b>						<b>Product no.</b>
<b>Fiber light cable bndl</b> consisting of: Fiber light cable Ø 2.5 mm TL 2.3 m (80662523), projector-side adapter (8095.07), and endoscope-side adapter (809509)				Ø 2.5 mm, 2.3 m long		<b>806625231</b>

III23 || Subject to modifications. Please note that some products may not be available in all countries. Please always take note of the information that is provided with the product. For more detailed information, please consult with your contact partner or directly with Richard Wolf GmbH.

# TÜBINGER MIC TRAINING DEVICE

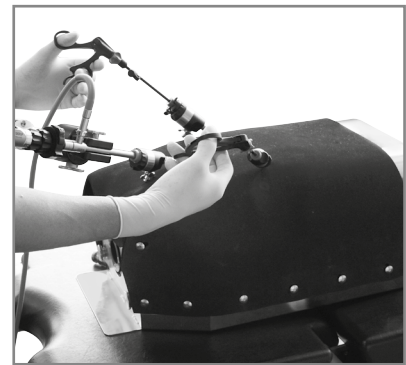
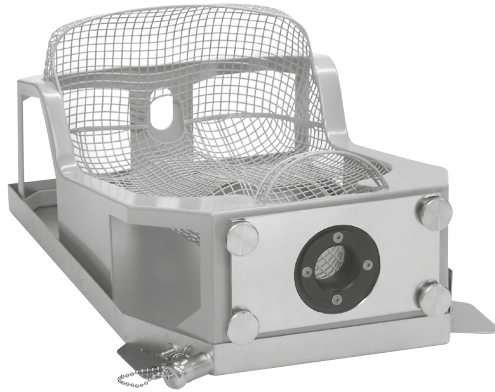

		Product no.
<b>Tübinger MIC trainer</b> with 3 abdominal walls (foam rubber)	(W x H x D) 560 x 350 x 230 mm	<b>9500.056</b>

Recommended accessories		Product no.
<b>Abdominal wall, foam rubber, PACK= 5 PCS</b>		<b>9500.051</b>
Available on request with transportation case		





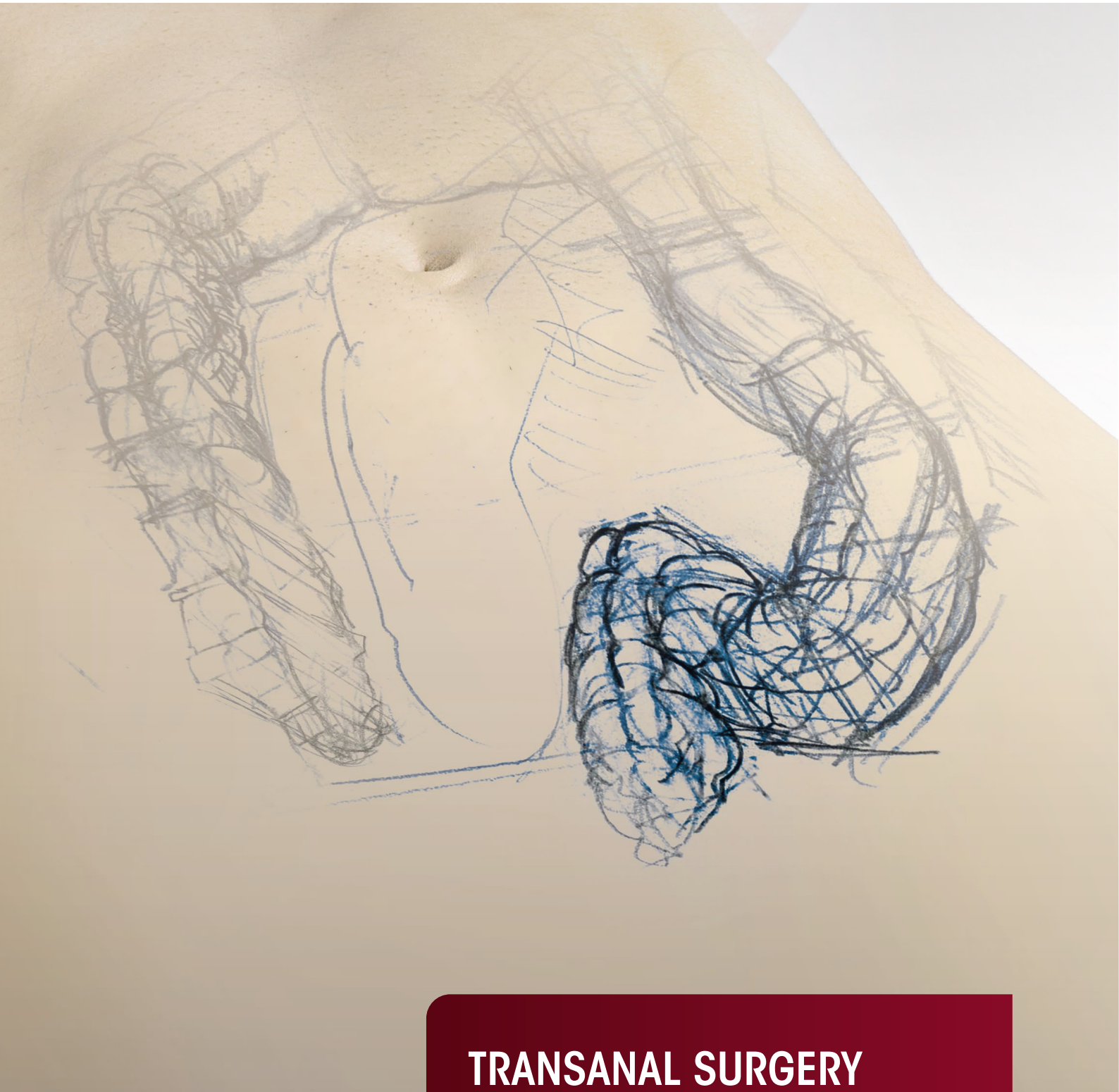

## TRANSANAL SURGERY

## TRANSANAL SURGERY

1

**BASIC SET**

2

**TEM SYSTEM/STEREO AND DOCUMENTATION TELESCOPE**

3

**SUPPORT ARM SYSTEM**

4

**TEM INSTRUMENT SET**

5

**ACCESSORIES FOR TEM COMBINATION SYSTEM 2232**

6

**HF CONNECTION CABLE**

**Note:**

The TEM pumps/devices combination system is no longer available as of May 2021.  
The following related instruments are still available to existing customers.

# BASIC TEM SET

## TRANSANAL ENDOSCOPIC SURGERY

Product	Product no	Quantity	Catalog/Section
PANOVIEW stereo endoscope 50° Ø 13.8 mm SL 259 mm	884080	1	TEM/system
TEM basic part	8840.20	1	TEM/system
TEM tube bndl	8840.021	1	TEM/system
TEM tube bndl	8840.041	1	TEM/system
Adapter with observation window	8840.25	1	TEM/system
Working insert for TEM	8840.241	1	TEM/system
Silicone sealing insert	8840.242	1	TEM/system
Sealing caps			
Sealing cap capacity 2.4–3.4 mm, red-orange (PACK= 10 PCS)	89.01	1	TEM/system
Sealing cap capacity 3.4–5.1 mm, sky-blue (PACK= 10 PCS)	89.02	1	TEM/system
Sealing cap capacity 5.1–6.0 mm, light gray (PACK= 10 PCS)	89.03	1	TEM/system
Sealing cap capacity 4–6 mm, red (PACK= 10 PCS)	89.141	1	TEM/system
Sealing cap capacity 7.5–8.5 mm, blue (PACK= 10 PCS)	89.161	1	TEM/system
Sealing cap capacity 13.0–13.8 mm, gray (PACK= 10 PCS)	89.10	1	TEM/system
HF suction tube TEM Ø 5.6 mm WL 305 mm	8840.731	1	TEM/instrument set
HF knife Ø 4.5 mm WL 433 mm, right	8840.711	1	TEM/instrument set
HF knife Ø 4.5 mm WL 433 mm, left	8840.712	1	TEM/instrument set
ERAGONmodular TEM grasping forceps mono Ø 5 mm bndl			
angled downward and curved to the right	83946217	1	TEM/instrument set
angled downward and curved to the left	83946227	1	TEM/instrument set
curved to the right	83946237	1	TEM/instrument set
curved to the left	83946247	1	TEM/instrument set
Metzenbaum scissors mono Ø 5 mm bndl	83940417	1	TEM/instrument set
Needle holder Ø 5 mm, angled downward	8840.605	1	TEM/instrument set
Titanium clip for TEM, PACK= 10 units (6 PCS)	4840764	1	TEM/instrument set

# STEREO AND DOCUMENTATION TELESCOPE

TEM SYSTEM

2





product design award  
2010

**HD** AUTOCLAVE

	Direction of view	SL	TL	Ø	Product no.
<p>PANOVIEW <b>Stereo endoscope 50°</b> <b>Ø 13.8 mm SL 259 mm</b></p> <p>with direct stereo and lateral documentation eyepiece, with irrigation channel</p>	50°	259 mm	410 mm	13.8 mm	<b>884080</b>

Recommended accessories		Product no.
<p><b>Perforated basket for stereo telescope</b> inner dimensions (W x H x D): 451 x 130 x 189 mm, outer dimensions (W x H x D): 477 x 139 x 196 mm</p>		<b>38010</b>
<p><b>Fiber light cable bndl</b> consisting of: Fiber light cable Ø 5 mm TL 2.3 m (80655023), projector-side adapter (8095.07), and endoscope-side adapter (809509)</p>	Ø 5.0 mm, 2.3 m long	<b>806650231</b>
<p>Fusion <b>Fiber light cable bndl</b> consisting of: Fiber light cable Ø 5 mm TL 2.3 m (80655023), projector-side adapter (8095.07), and endoscope-side adapter (809509)</p>	Ø 5.0 mm, 2.3 m long	<b>806550231</b>

i123 | Subject to modifications. Please note that some products may not be available in all countries. Please always take note of the information that is provided with the product. For more detailed information, please consult with your contact partner or directly with Richard Wolf GmbH.

# ALTERNATIVES

## TO STEREO AND DOCUMENTATION TELESCOPE 884080

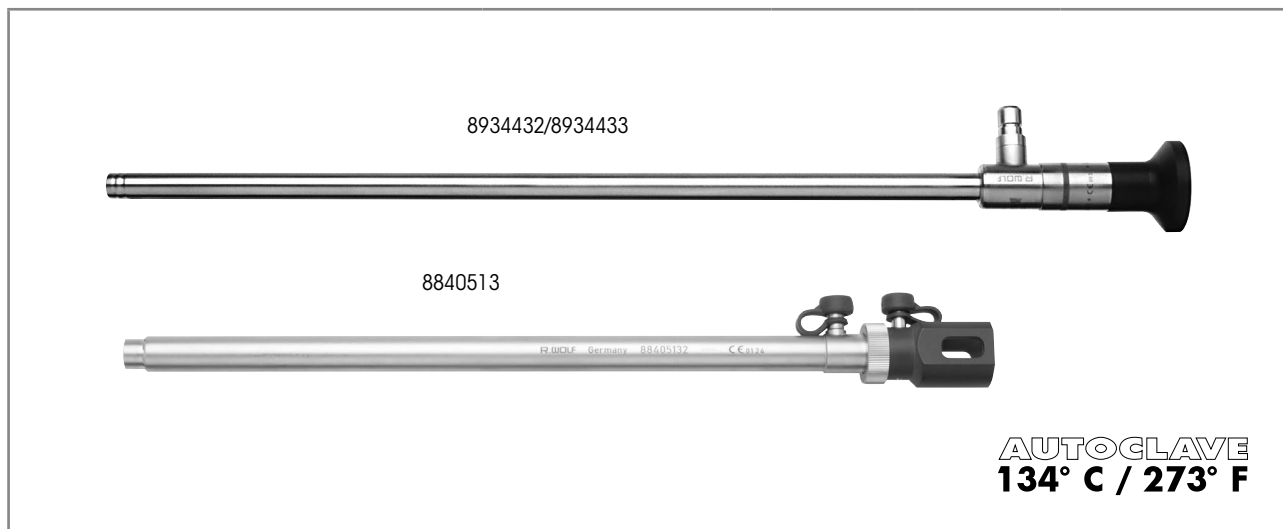

	Direction of view	WL	TL	Ø	Product no.
PANOVIEW Telescope 30° Ø 10 mm WL 307 mm	30°	307 mm	375 mm	10 mm	<b>8934.432</b>
PANOVIEW Telescope 50° Ø 10 mm WL 310 mm	50°	310 mm	375 mm	10 mm	<b>8934.433</b>
also:					
Telescope cover tube bndl	consisting of: TEM inner tube Ø 11.5 mm WL 282 mm (88405131) TEM outer tube Ø 14 mm WL 272 mm (88405132) Tube with Luer-Lock connector Ø 4 mm (886.01) Tube with Luer-Lock connector (886.00)				<b>8840513</b>

Recommended accessories	Product no.
Perf. basket for standard telescope 2	inner dimensions (W x H x D): 454 x 52 x 40 mm, outer dimensions (W x H x D): 481 x 54 x 59 mm <b>38016</b>
<b>Fiber lightcable bndl</b> consisting of: Fiber light cable Ø 5 mm TL 2.3 m (80665023), projector-side adapter (8095.07), and endoscope-side adapter (809509)	Ø 5.0 mm, 2.3 m long <b>806650231</b>
Fusion <b>Fiber light cable bndl</b> consisting of: Fiber light cable Ø 5 mm TL 2.3 m (80655023), projector-side adapter (8095.07), and endoscope-side adapter (809509)	Ø 5.0 mm, 2.3 m long <b>806550231</b>

# TEM INSTRUMENT SET

## PROCTOSCOPE TUBES

TEM SYSTEM

2

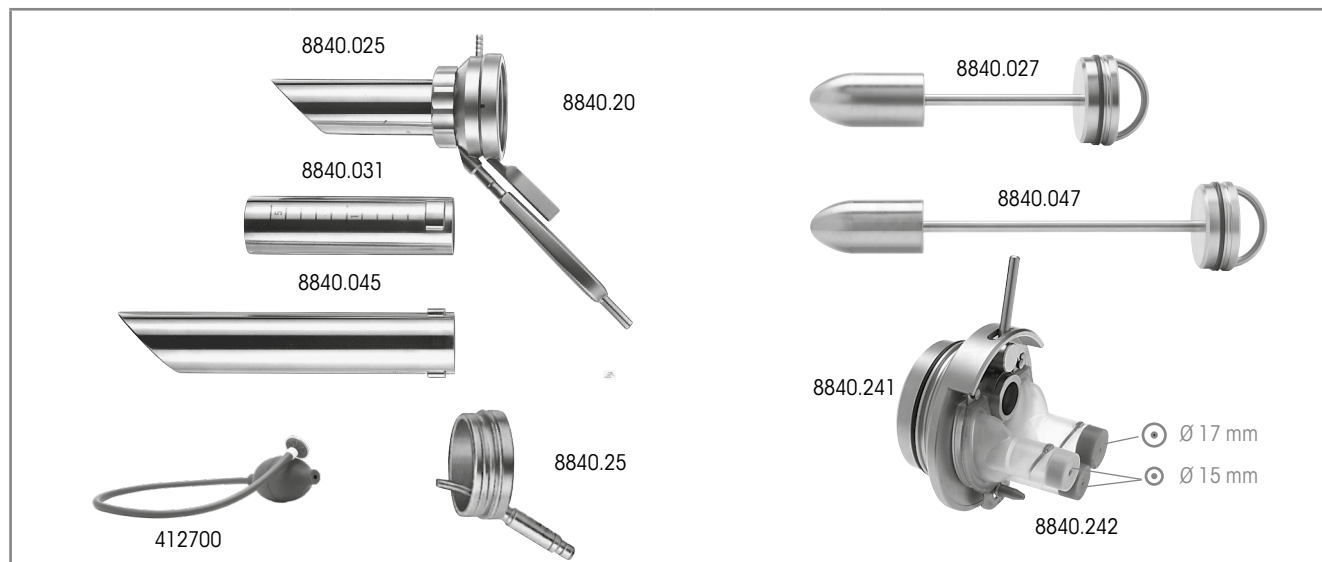

	TEM obturator Ø 36 mm WL 175 mm 8840.027	TEM obturator Ø 36 mm WL 255 mm 8840.047	Product no.
<b>TEM tube bndl</b> consisting of: TEM tube Ø 40 mm WL 137 mm (8840.025), TEM obturator Ø 36 mm WL 175 mm (8840.027)	•		<b>8840.021</b>
<b>TEM tube bndl</b> consisting of: TEM tube Ø 40 mm WL 137 mm (8840.031), TEM obturator Ø 36 mm WL 175 mm (8840.027)	•		<b>8840.0311</b>
<b>TEM tube bndl</b> consisting of: TEM tube Ø 40 mm WL 217 mm (8840.045), TEM obturator Ø 36 mm WL 255 mm (8840.047)		•	<b>8840.041</b>
<b>TEM basic part</b>			<b>8840.20</b>
<b>Adapter</b> with observation window and illumination insert for basic part 8840.20			<b>8840.25</b>
<b>Working insert for TEM bndl</b> consisting of:	Working insert for TEM (8840.241) Silicone sealing insert (8840.242) Sealing cap capacity 2.4–3.4 mm, red-orange (89.01) Sealing cap capacity 3.4–5.1 mm, sky-blue (89.02) Sealing cap capacity 5.1–6.0 mm, light gray (89.03) Sealing cap capacity 4–6 mm, red (89.141) Sealing cap capacity 7.5–8.5 mm, blue (89.161) Sealing cap capacity 13.0–13.8 mm, gray (89.10)		<b>8840.2411</b>
<b>Hand blower sterile (PACK= 5 PCS)</b> Hand blower with disposable filter Ø 49 mm, TL 567 mm			<b>412700</b>

1123 | Subject to modifications. Please note that some products may not be available in all countries. Please always take note of the information that is provided with the product. For more detailed information, please consult with your contact partner or directly with Richard Wolf GmbH.

# TEM INSTRUMENT SET

## PROCTOSCOPE TUBES

Spare parts	Product no.
<b>Silicone sealing insert</b> (PACK= 3 PCS) with 3 valve ports, (2 valve ports for auxiliary instruments up to 6 mm), (1 valve port for auxiliary instruments from 6 to 11 mm)	<b>8840.242</b>
<b>Sealing cap capacity 2.4–3.4 mm</b> , red-orange (PACK= 10 PCS)	<b>89.01</b>
<b>Sealing cap capacity 3.4–5.1 mm</b> , sky-blue (PACK= 10 PCS)	<b>89.02</b>
<b>Sealing cap capacity 5.1–6.0 mm</b> , light gray (PACK= 10 PCS)	<b>89.03</b>
<b>Sealing cap capacity 4–6 mm</b> , red (PACK= 10 PCS)	<b>89.141</b>
<b>Sealing cap capacity 7.5–8.5 mm</b> , blue (PACK= 10 PCS)	<b>89.161</b>
<b>Sealing cap capacity 13.0–13.8 mm</b> , gray (PACK= 10 PCS)	<b>89.10</b>

## U-SHAPED SUPPORT ARM

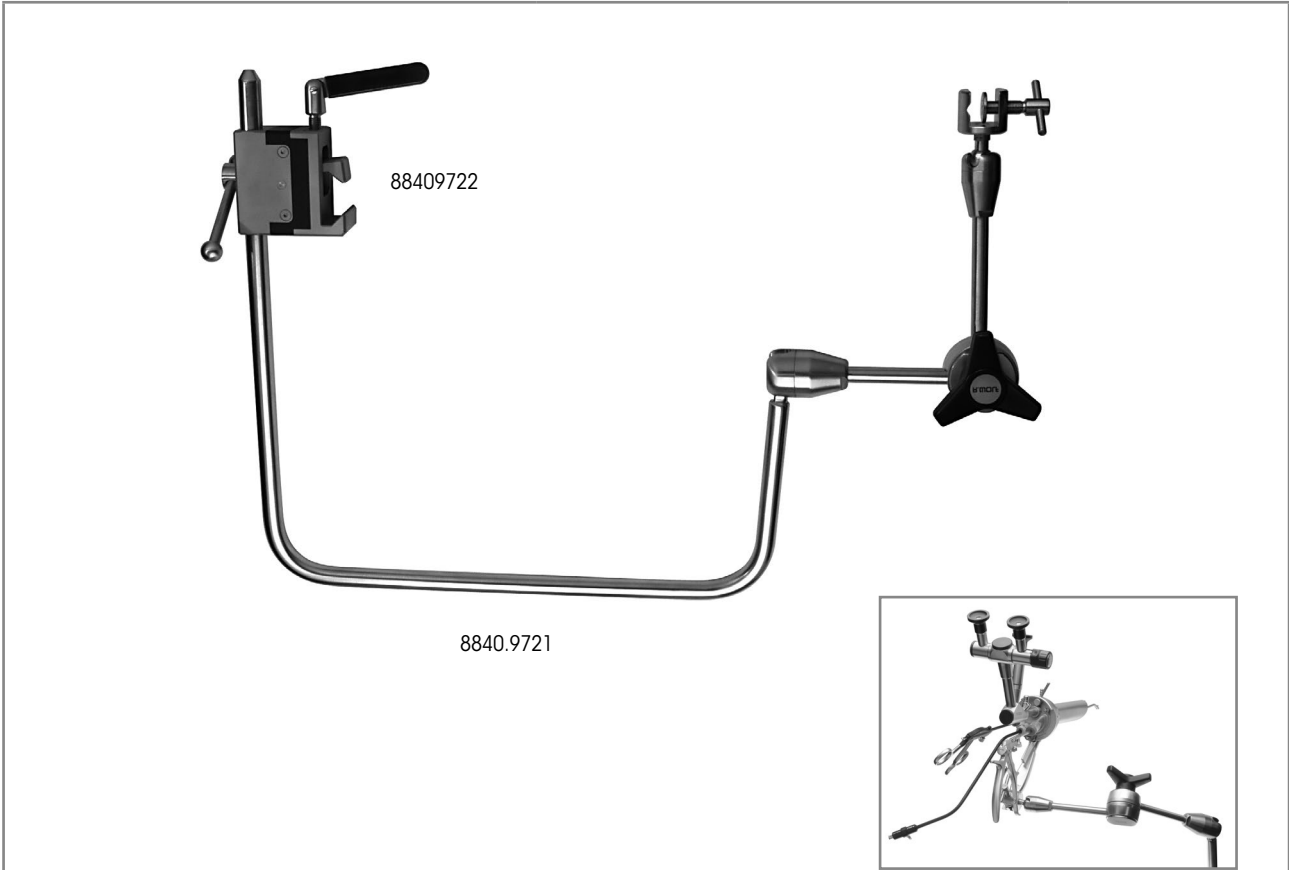





		Product no.
<b>U-shaped support arm for TEM</b> with clamping prism	reusable	<b>8840.9721</b>
Also required:		
<b>Clamp socket</b> insulated	for attachment to the operating table (standard rail), reusable	<b>88409722</b>

1123 | Subject to modifications. Please note that some products may not be available in all countries. Please always take note of the information that is provided with the product. For more detailed information, please consult with your contact partner or directly with Richard Wolf GmbH.

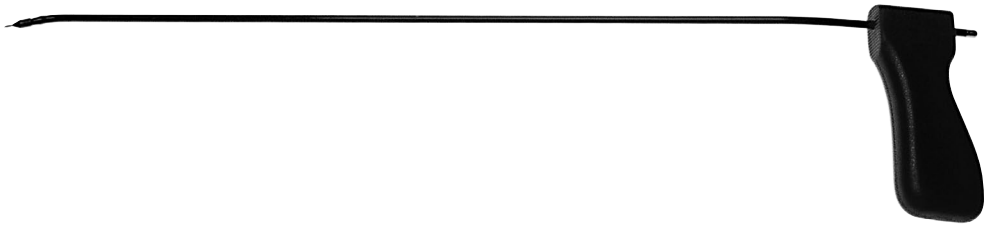

## HF SUCTION TUBE / HF KNIFE

				
		Ø	WL	Product no.
 curved	<b>HF suction tube TEM Ø 5.6 mm WL 305 mm</b> integrated HF electrode, capacity 3 mm	6 mm	305 mm	<b>8840.731</b>
				
<b>with ceramic insulation</b>		Ø	WL	Product no.
 curved	<b>HF knife Ø 4.5 mm WL 433 mm</b> for right-handed users	4.5 mm	433 mm	<b>8840.711</b>
 curved	<b>HF knife Ø 4.5 mm WL 433 mm</b> for left-handed users	4.5 mm	433 mm	<b>8840.712</b>







HF connection cable: see page TEM16







**ERAGON** modular

**TEM GRASPING FORCEPS Ø 5.0 MM INSULATED**

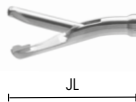
INSTRUMENT SET

4

		Handle, axial			
 All jaw inserts and sheath tubes can also be combined with ERAGONaxial.					
		with lock	without lock, with HF connector	without lock, with HF connector	with lock, not rotatable
Rotatable knob	Product no.	83930082	83930083	83930084	83930085
	8988	•	•	•	•







Jaw insert		Sheath tube, Ø 5.0 mm, insulated		Handle, pistol-shaped	Complete instrument
 					• Jaw insert with sheath tube • Handle
	JL*	Product no.	8394933	83930074	Product no.
 angled downward and curved to the right single-action	28 mm	8394621	•	•	<b>83946217</b>
 angled downward and curved to the left single-action	28 mm	8394622	•	•	<b>83946227</b>
 curved to the right single-action	25mm	8394623	•	•	<b>83946237</b>

\* JL = jaw length when jaw section closed (approximate measurements)  
 HF connection cable: see page TEM16

1123 | Subject to modifications. Please note that some products may not be available in all countries. Please always take note of the information that is provided with the product. For more detailed information, please consult with your contact partner or directly with Richard Wolf GmbH.

**ERAGON** modular

**TEM GRASPING FORCEPS / SCISSORS Ø 5.0 MM INSULATED**







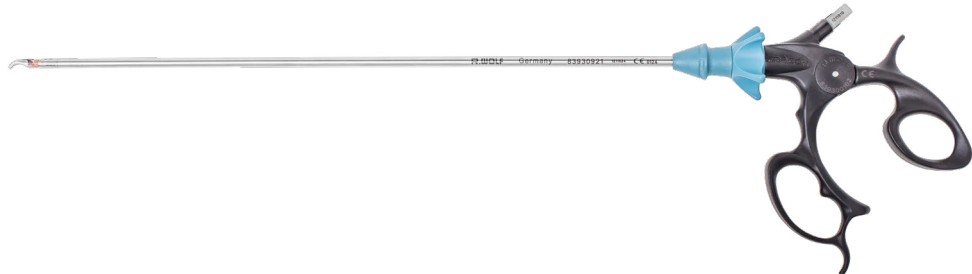

Jaw insert			Sheath tube, Ø 5.0 mm, insulated	Handle, pistol-shaped		Complete instrument • Jaw insert with sheath tube • Handle
			 WL 450 mm	 without lock, with HF, mono	 with lock, with HF, mono	
	JL*	Product no.	8394933	83930073	83930074	Product no.
<b>TEM grasping forceps mono Ø 5 mm bndl</b>  curved to the left single-action	25 mm	8394624	•		•	<b>83946247</b>
<b>Metzenbaum scissors mono Ø 5 mm bndl</b>  double-action	23 mm	8394.041	•	•		<b>83940417</b>

\* JL = jaw length when jaw section closed (approximate measurements)  
 HF connection cable: see page TEM16

1123 || Subject to modifications. Please note that some products may not be available in all countries. Please always take note of the information that is provided with the product. For more detailed information, please consult with your contact partner or directly with Richard Wolf GmbH.

**ERAGON** bipolar  
MODULAR BIPOLAR INSTRUMENTS, 5.5 MM  
ROTATABLE





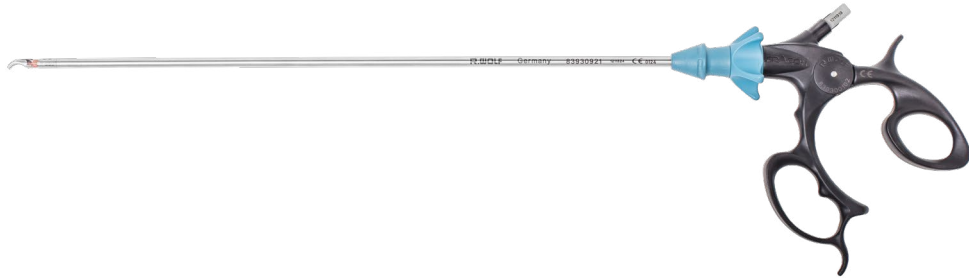

Jaw insert		Sheath tube Ø 5.5 mm		Handle, pistol-shaped, bipo	Complete instrument • Jaw insert • Sheath tube • Handle	
						
		SL 320 mm	SL 435 mm	rotatable		
	JL*	Product no.	83930921	82340024	839300102	Product no.
 Grasping forceps bipo Ø 5.5 mm bndl	21 mm	83930031	•		•	<b>839300312</b>
		839400310			•	
 Maryland dissector bipo Ø 5.5 mm bndl	23 mm	83930032	•		•	<b>839300322</b>
		839400320			•	
 Dolphin dissector bipo Ø 5.5 mm bndl	21 mm	83930033	•		•	<b>839300332</b>
		839400330			•	
 Grasping forceps bipo Ø 5.5 mm bndl	23 mm	83930034	•		•	<b>839300342</b>
		839400340			•	
 Preparation forceps bipo Ø 5.5 mm bndl	19 mm	83930035	•		•	<b>839300352</b>
		839400350			•	

\* JL = jaw length when jaw section closed (approximate measurements)  
Bipolar connection cable: see page TEM17







**ERAGON** bipolar  
MODULAR BIPOLAR INSTRUMENTS, 5.5 MM  
ROTATABLE

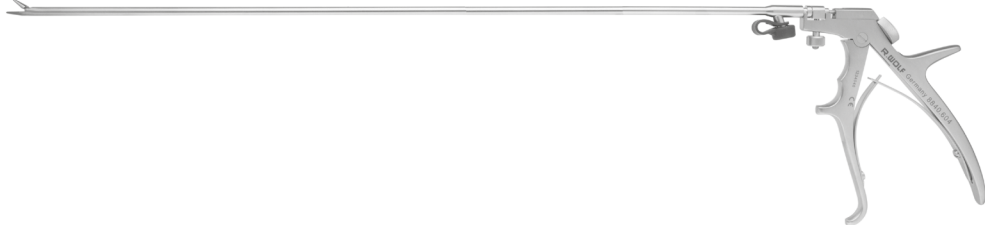

Jaw insert			Sheath tube Ø 5.5 mm		Handle, pistol-shaped, bipo	Complete instrument • Jaw insert • Sheath tube • Handle
			SL 320 mm	SL 435 mm	rotatable	
			Product no.	83930921	82340024	839300102
 <b>Sterilization forceps bipo</b> Ø 5.5 mm bndl by Hasskamp	19 mm	83930036	•		•	<b>839300362</b>
 <b>Münster grasping forceps bipo</b> Ø 5.5 mm bndl	22 mm	83930037	•		•	<b>839300372</b>
		83930038	•		•	<b>839300382</b>
 <b>Maryland dissector bipo</b> Ø 5.5 mm bndl	15 mm	839400380		•	•	<b>839400382</b>
 <b>Metzenbaum scissors bipo</b> Ø 5.5 mm bndl	22 mm	83930041	•		•	<b>839300412</b>
		839400410		•	•	<b>839400412</b>

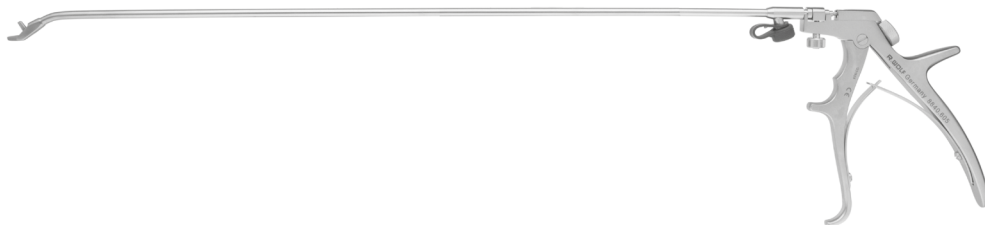
\* JL = jaw length when jaw section closed (approximate measurements)  
Bipolar connection cable: see page TEM17

# NEEDLE HOLDER / TEM CLIP APPLICATOR / TITANIUM CLIP

				
with ceramic insulation		Ø	WL	Product no.
 straight	Needle holder Ø 5 mm	5 mm	400 mm	<b>8840.604</b>
				
with irrigation connector		Ø	WL	Product no.
 angled downward	Needle holder Ø 5 mm	5 mm	400 mm	<b>8840.605</b>
				
with irrigation tap		Ø	WL	Product no.
	TEM Clip applicator Ø 6 mm WL 435 mm	6 mm	435 mm	<b>8840.762</b>
Titanium clip		Ø	WL	Product no.
	<b>Titanium clip for TEM</b> sterile, PACK= 10 units of 6 pieces, incl. connecting part for clip	5 mm	405 mm	<b>4840764</b>

# TEM COMBINATION SYSTEM 2232

## ACCESSORIES

Spare parts	Product no.
<b>High-pressure connection tube bndl</b> consisting of: High-pressure connection tube L 1 m (8170.801) Open end wrench WS 30 (9500.016) with DIN connector	<b>8170.8011</b>
<b>High-pressure connection tube L 1 m</b> with PIN Index connector	<b>8170.802</b>
<b>High-pressure connection tube L 1 m</b> with ISO Index connector	<b>8107.803</b>
<b>CO<sub>2</sub> connection tube L 5 m</b> for centralized CO <sub>2</sub> gas supply in accordance with DIN EN 13260-2/2004	<b>8170.3111</b>
<b>TEM tube set</b> sterile, disposable	<b>4170.801</b>
<b>TEM tube set for Erbe instrument</b> sterile, disposable	<b>4170.804</b>
<b>Open end wrench WS 30</b>	<b>9500.016</b>
<b>Bottle holder for gas bottle Ø 80–90 mm</b> for holding CO <sub>2</sub> bottles	<b>2221.951</b>







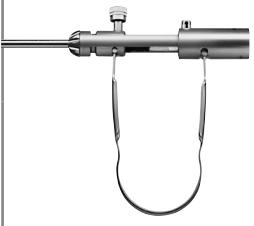

# HF CONNECTION CABLE MONO 8106xxx

Instrument connector	Device connector		Product no.
<p><b>WOLF Instruments/surgical generator</b></p> 		<p>HF connection cable mono L 3 m</p>	<p><b>8106.032</b></p>
	<p>Erbe (ACC/ICC/VIO)/BOWA (EU) R. Wolf HF surgical generator 400 kHz 2260002</p>	<p>HF connection cable mono L 5 m</p>	<p><b>8106.052</b></p>
		<p>HF connection cable mono L 3 m</p>	<p><b>8106.132</b></p>
	<p>Erbe (T series)</p>	<p>HF connection cable mono L 5 m</p>	<p><b>8106.152</b></p>
		<p>HF connection cable mono L 3 m</p>	<p><b>8106.031</b></p>
	<p>Martin (M-version)/Berchold/ Aesculap</p>	<p>HF connection cable mono L 5 m</p>	<p><b>8106.051</b></p>
<p><b>HF electrodes, monopolar</b></p> 		<p>HF connection cable mono L 3 m</p>	<p><b>8106.033</b></p>
<p>Bovie/Valleylab/Erbe (Int.)/ BOWA (Int.) R. Wolf HF surgical generator 400 kHz 2260001</p>	<p>HF connection cable mono L 5 m</p>	<p><b>8106.053</b></p>	
	<p>HF connection cable mono L 3 m</p>	<p><b>8106.034</b></p>	
<p>BOWA (Int./EU) Eschmann and other devices with 4 mm plugs R. Wolf HF surgical generator 400 kHz 2260001/2260002</p>	<p>HF connection cable mono L 5 m</p>	<p><b>8106.054</b></p>	

1123 | Subject to modifications. Please note that some products may not be available in all countries. Please always take note of the information that is provided with the product. For more detailed information, please consult with your contact partner or directly with Richard Wolf GmbH.



# HF BIPOLAR CONNECTION CABLE 8108XXX

Instrument connector	Device connector		Product no.
<b>WOLF Bipolar forceps</b>  	 Erbe (ACC/ICC/T)/BOWA (EU) R. Wolf HF surgical generator 400 kHz 2260001/2260002	HF connection cable bipo, L 3 m	8108.032
		HF connection cable bipo, L 5 m	8108.052
	 Martin (Int.)/ 2 pin Valleylab/BOWA (Int.) R. Wolf HF surgical generator 400 kHz 2260001/2260002	HF connection cable bipo, L 3 m	8108.033
		HF connection cable bipo, L 5 m	8108.053
	 WOLF/Martin (M-version)/Berchold/ Aesculap	HF connection cable bipo, L 3 m	8108.031
		HF connection cable bipo, L 5 m	8108.051
<b>Bipolar tweezers connection</b>  	 Erbe (ACC/ICC/T)/BOWA (EU) R. Wolf HF surgical generator 400 kHz 2260001/2260002	HF connection cable bipo, L 3 m	8108.132
		HF connection cable bipo, L 5 m	8108.152
	 Martin (Int.)/ 2 pin Valleylab/BOWA (Int.) R. Wolf HF surgical generator 400 kHz 2260001/2260002	HF connection cable bipo, L 3 m	8108.133
		HF connection cable bipo, L 5 m	8108.153
	 Martin (m version)/Berchold/ Aesculap	HF connection cable bipo, L 3 m	8108.131
		HF connection cable bipo, L 5 m	8108.151
	 EMC Dolley	HF connection cable bipo, L 3 m	8108135

1123 || Subject to modifications. Please note that some products may not be available in all countries. Please always take note of the information that is provided with the product. For more detailed information, please consult with your contact partner or directly with Richard Wolf GmbH.



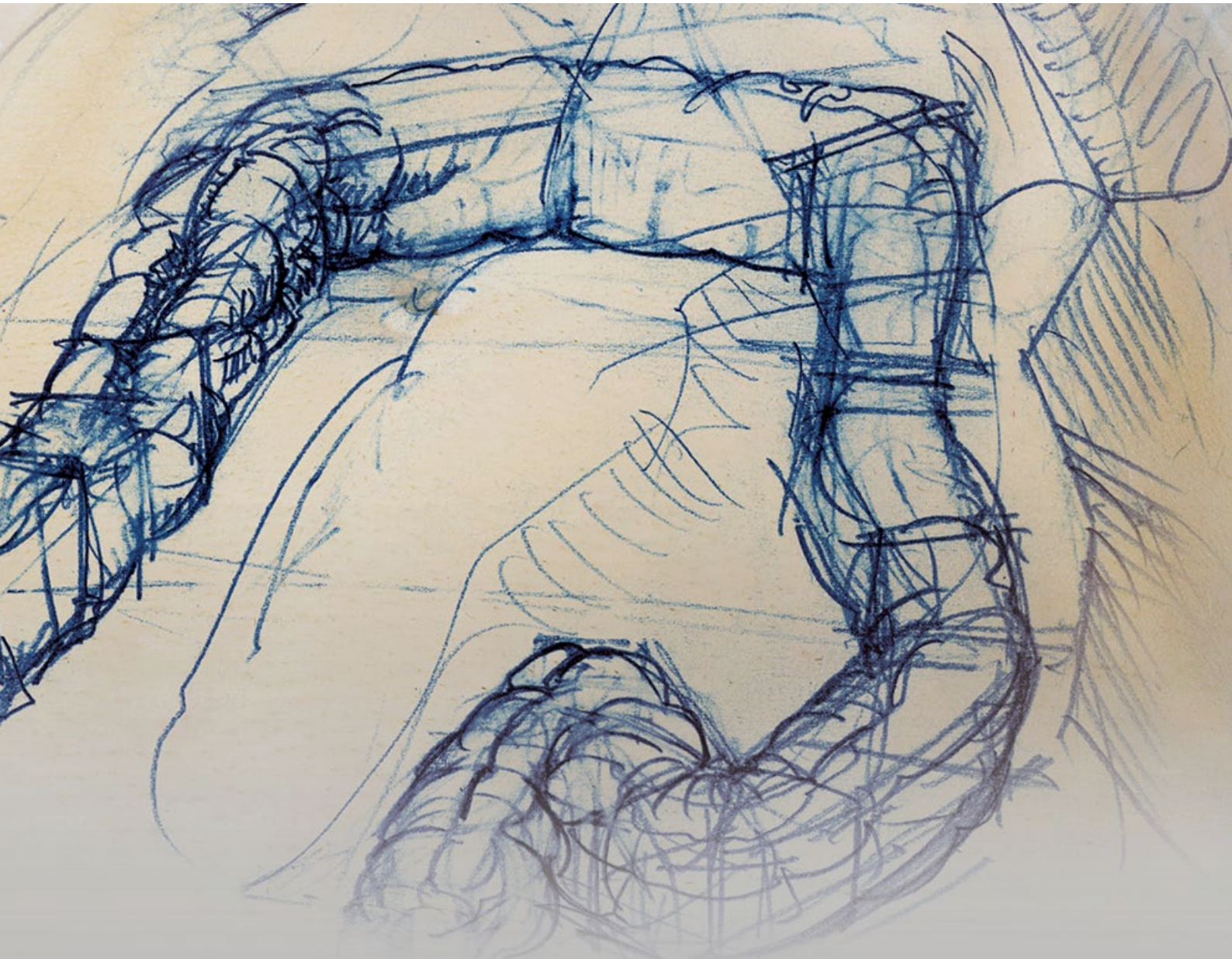

## PROCTO-RECTOSCOPY

## PROCTO-RECTOSCOPY

1

---

**DISPOSABLE PROCTO-RECTOSCOPE TUBES 4844**

---

2

---

**PROCTOSCOPE TUBES 8836 / AUXILIARY INSTRUMENTS**

---

3

---

**ASPIRATION-LIGATURE INSTRUMENT FOR HAEMORRHOIDS**

---

4

---

**RECTOSCOPE TUBES 8834**

---

5

---

**OPERATING RECTOSCOPE 8834**

---

6

---

**AUXILIARY INSTRUMENTS FOR RECTOSCOPY**

---

7

---

**ADDITIONS FOR RECTOSCOPY**

---

# DISPOSABLE PROCTO-RECTOSCOPE TUBES 4844

## WITH COLD-LIGHT ILLUMINATION

DISPOSABLE PROCTO/  
RECTOSCOPE TUBES



	Ø	WL	Product no.
<b>Rectoscopy tube Ø 21 mm WL 250 mm</b> with obturator, graduated, sterile, disposable (PACK= 10 PCS)	21 mm	250 mm	<b>4844255</b>
<b>Proctoscopy tube Ø 21 mm WL 117 mm</b> with obturator, graduated, sterile, disposable (PACK= 10 PCS)	21 mm	117 mm	<b>4844120</b>
<b>Procto-rectoscopy handle</b> with cold-light illumination, reusable			<b>8838.90</b>
<b>Sealing cap</b> with observation window for handle 883890			<b>8838.60</b>
<b>Hand blower</b> with disposable filter, (sterile, PACK= 5 PCS)			<b>412700</b>

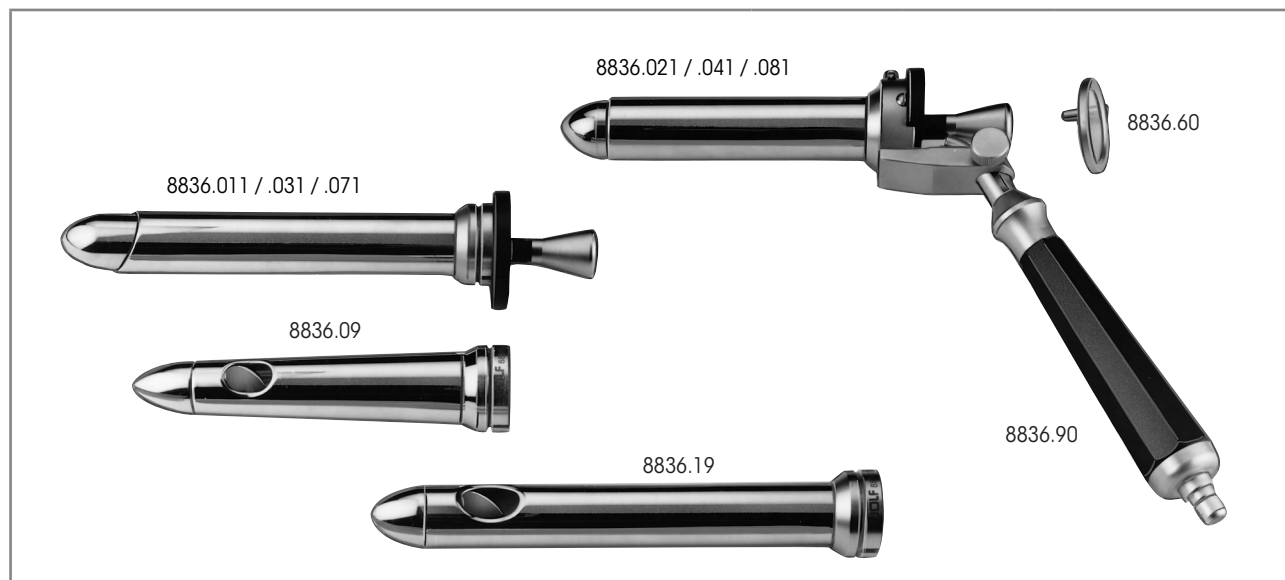

## PROCTOSCOPE TUBES 8836



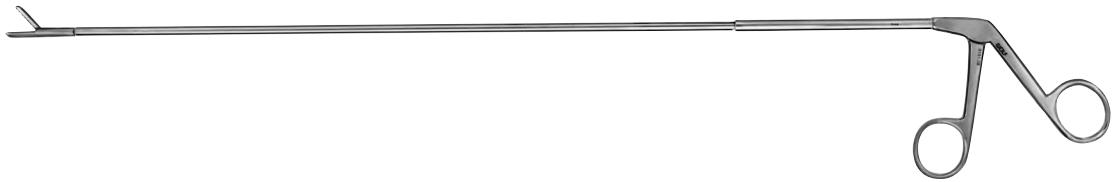

	Ø	WL	Product no.
<b>Proctoscope handle</b> with cold-light illumination and removable connection part			<b>8836.90</b>
<b>Proctoscope tube bndl, straight,</b> consisting of: Proctoscope tube Ø 21.5 mm WL 90 mm (8836.025), proctoscope obturator Ø 19 mm TL 156 mm (8836.027)	21 mm	90 mm	<b>8836.021</b>
<b>Proctoscope tube bndl, oblique,</b> consisting of: Proctoscope tube Ø 21.5 mm WL 120 mm (8836.015), proctoscope obturator Ø 19 mm TL 185 mm (8836.017)		120 mm	<b>8836.011</b>
<b>Proctoscope tube bndl, straight,</b> consisting of: Proctoscope tube bndl Ø 24 mm WL 60 mm (8836.085), proctoscope obturator Ø 22 mm TL 140 mm (8836.087)	24 mm	60 mm	<b>8836.081</b>
<b>Proctoscope tube bndl, oblique,</b> consisting of: Proctoscope tube Ø 24 mm WL 60 mm (8836.075), proctoscope obturator Ø 22 mm TL 140 mm (8836.077)			<b>8836.071</b>
<b>Proctoscope tube bndl, straight,</b> consisting of: Proctoscope tube Ø 18.5 mm WL 90 mm (8836.045), proctoscope obturator Ø 16 mm TL 154 mm (8836.047)	18 mm	90 mm	<b>8836.041</b>
<b>Proctoscope tube bndl, oblique,</b> consisting of: Proctoscope tube Ø 18.5 mm WL 120 mm (8836.035), proctoscope obturator Ø 16 mm TL 185 mm (8836.037)		120 mm	<b>8836.031</b>
<b>Proctoscope tube Ø 18–24 mm WL 113 mm,</b> TL 127 mm, conical with lateral window	Conical 18–24 mm	113 mm	<b>8836.09</b>
<b>Proctoscope tube Ø 20 mm WL 148 mm</b> TL 163 mm, cylindrical with lateral window	cylindrical 20 mm	148 mm	<b>8836.19</b>
<b>Cover plate</b> with observation window for handle 8836.90			<b>8836.60</b>

## AUXILIARY INSTRUMENTS FOR PROCTOSCOPY

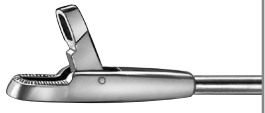

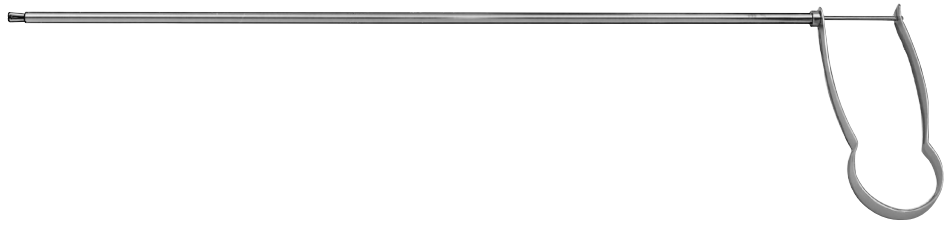
		Sheath Ø	Jaw section Ø	WL	Product no.
	<b>Biopsy forceps WL 270 mm, smooth,</b> jaw section straight, sheath straight	3 mm	4 mm	270 mm	<b>8280.23</b>
	<b>Biopsy forceps WL 270 mm, serrated,</b> jaw section straight, sheath straight	3 mm	4 mm	270 mm	<b>8280.22</b>
	<b>Tumor forceps WL 270 mm, through-cutting,</b> jaw section straight, sheath straight	3 mm	6 mm	270 mm	<b>8280.26</b>



		Sheath Ø	WL	Product no.
	<b>Sponge forceps Ø 3.0 mm WL 300 mm</b>	3 mm	300 mm	<b>8148.02</b>

## ASPIRATION-LIGATURE INSTRUMENT FOR HAEMORRHOIDS

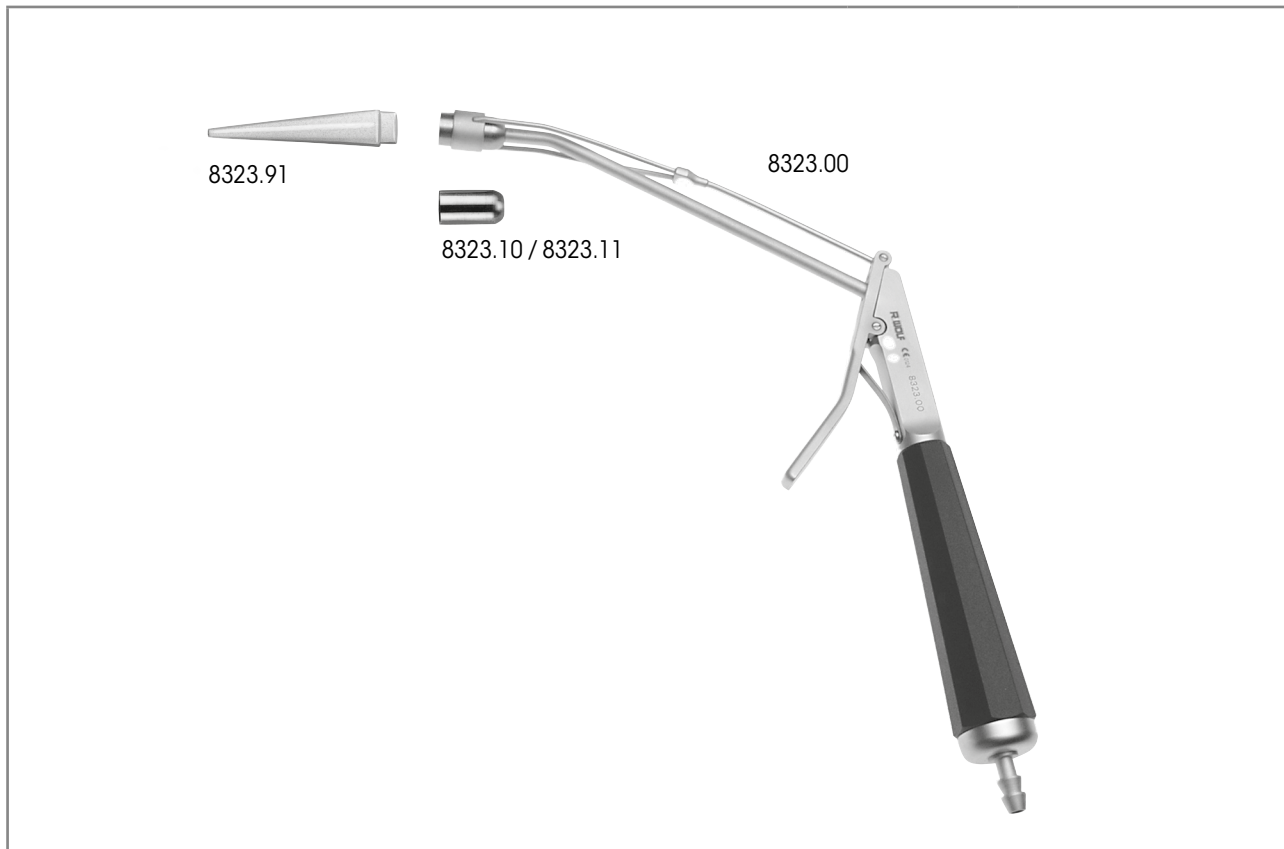

	WL	Product no.
<b>Suction ligature instrument WL 145 mm</b>	145 mm	<b>8323.00</b>
<b>Suction head large</b>		<b>8323.10</b>
<b>Suction head small</b>		<b>8323.11</b>
<b>Loading cone WL 53 mm</b>	53 mm	<b>8323.91</b>
<b>For use through:</b>		
<b>Proctoscope handle</b> with cold light illumination and removable connector		<b>8836.90</b>
<b>Proctoscope tube bndl, oblique</b> consisting of: Proctoscope tube Ø 24 mm WL 60 mm (8836.075), Proctoscope obturator Ø 22 mm TL 140 mm (8836.077)		<b>8836.071</b>

1123 || Subject to modifications. Please note that some products may not be available in all countries. Please always take note of the information that is provided with the product. For more detailed information, please consult with your contact partner or directly with Richard Wolf GmbH.



# RECTOSCOPE TUBES 8834

## WITH COLD-LIGHT ILLUMINATION

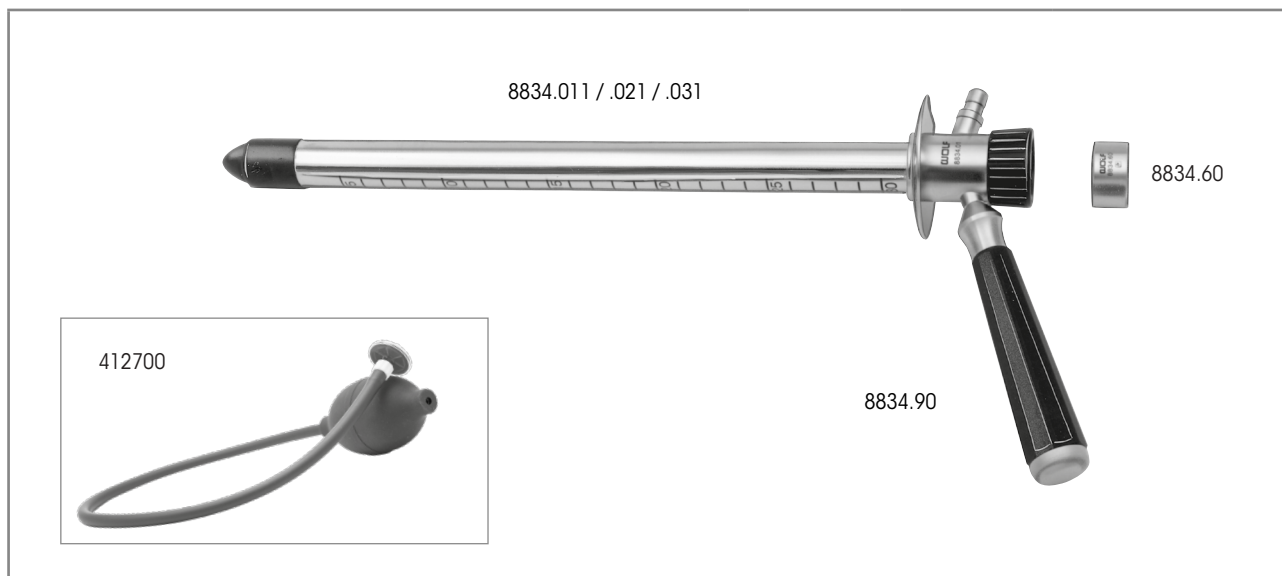

	Ø	WL	Product no.
<b>Rectoscope handle</b> with cold-light illumination, reusable			<b>8834.90</b>
<b>Rectoscope tube bndl,</b> consisting of: Rectoscope tube Ø 22 mm WL 310 mm (8834.015), rectoscope obturator Ø 18 mm TL 378 mm (8834.017)	22 mm	310 mm	<b>8834.011</b>
<b>Rectoscope tube bndl,</b> consisting of: Rectoscope tube Ø 22 mm WL 260 mm (8834.025), rectoscope obturator Ø 18 mm TL 328 mm (8834.027)	22 mm	260 mm	<b>8834.021</b>
<b>Rectoscope tube bndl,</b> consisting of: Rectoscope tube Ø 22 mm WL 210 mm (8834.035), rectoscope obturator Ø 18 mm TL 278 mm (8834.037)	22 mm	210 mm	<b>8834.031</b>
<b>Sealing cap</b> with observation window for handle 8834.90			<b>8834.60</b>
<b>Hand blower</b> with disposable filter, (sterile, PACK= 5 PCS)			<b>412700</b>

# OPERATING RECTOSCOPE 8834

WITH COLD-LIGHT ILLUMINATION

OPERATING RECTOSCOPE

5

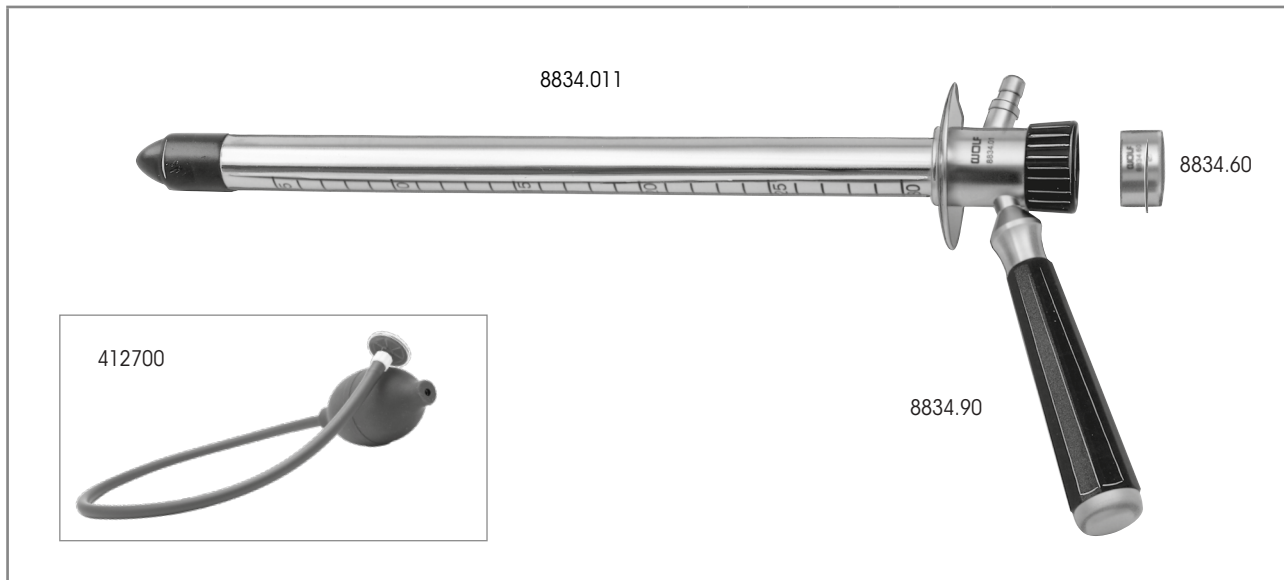

	Ø	WL	Product no.
<b>Rectoscope handle</b> with cold-light illumination, reusable			<b>8834.90</b>
<b>Rectoscope tube bndl,</b> consisting of: Rectoscope tube Ø 22 mm WL 310 mm (8834.015), rectoscope obturator Ø 18 mm TL 378 mm (8834.017)	22 mm	310 mm	<b>8834.011</b>
<b>Sealing cap</b> with observation window for handle 8834.90			<b>8834.60</b>
<b>Hand blower</b> with disposable filter, (sterile, PACK= 5 PCS)			<b>412700</b>

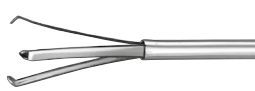

	Sheath Ø	WL	Product no.
 <b>Sponge forceps Ø 3.0 mm WL 300 mm</b>	3 mm	300 mm	<b>8148.02</b>

||23 || Subject to modifications. Please note that some products may not be available in all countries. Please always take note of the information that is provided with the product. For more detailed information, please consult with your contact partner or directly with Richard Wolf GmbH.

## AUXILIARY INSTRUMENTS FOR RECTOSCOPY

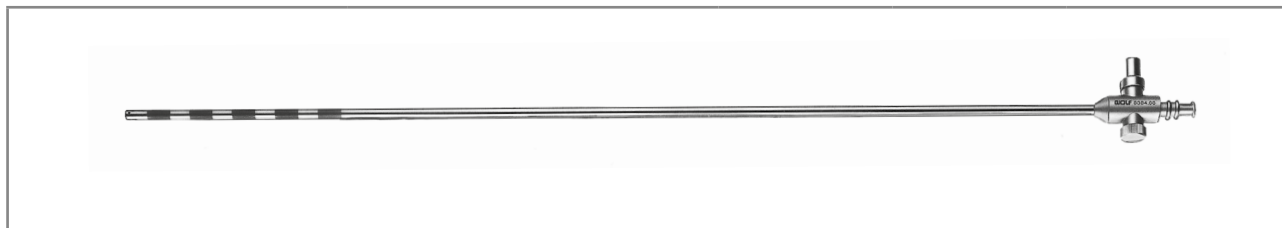

		Ø	WL	Product no.
	<b>Suction tube OD 4.7 mm WL 450 mm,</b> graduated with 3 mm Luer connector	4.7 mm	450 mm	<b>8384.68</b>



		Ø	WL	Product no.
	<b>Sponge forceps Ø 5.0 mm WL 400 mm</b>	5 mm	400 mm	<b>8148.01</b>

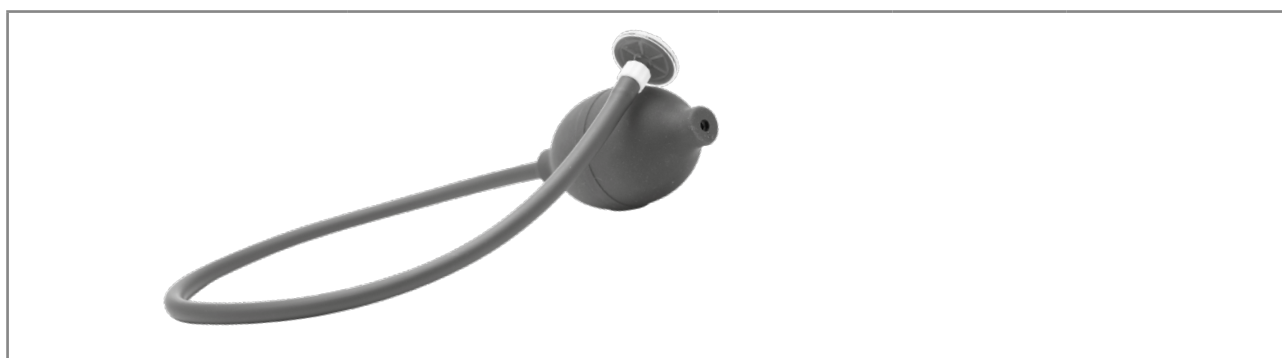

		Ø	TL	Product no.
	<b>Hand blower</b> with disposable filter, sterile (PACK= 5 PCS)	49 mm	567 mm	<b>412700</b>

**ADDITIONS**  
FOR RECTOSCOPY

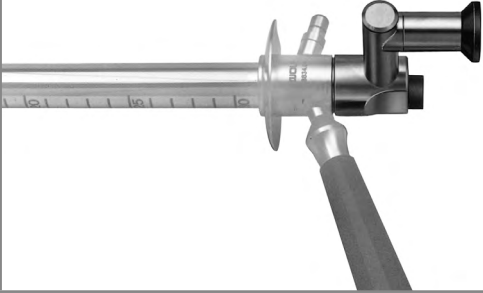
		Product no.
	<p><b>Operation connection capacity 6 mm</b> with angled viewing, reusable</p>	<p><b>8834.25</b></p>

||23 || Subject to modifications. Please note that some products may not be available in all countries. Please always take note of the information that is provided with the product. For more detailed information, please consult with your contact partner or directly with Richard Wolf GmbH.



