



Basket System

Universal perforated basket

Basket System

The universal solution

The universal basket system from Richard Wolf provides safe and gentle accommodation for the valuable instrument set during sterilization, transport, and storage.

The universal basket concept allows virtually any basket configuration to be put together.



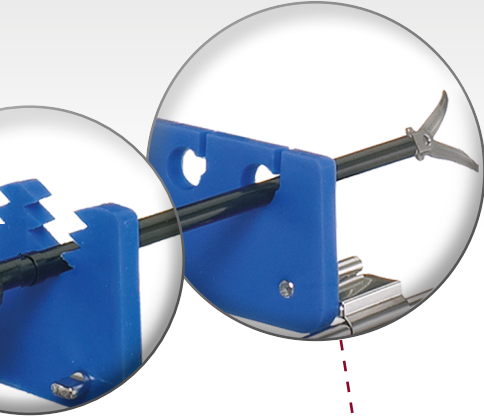

Top-heavy instruments are securely fixed with an open and a closed silicone holder.



The patented double frame prevents the basket mesh from "becoming frayed" and hence causing injury to the user and damage to the sterilization packaging.

Our double frame therefore ensures maximum safety and a long service life.

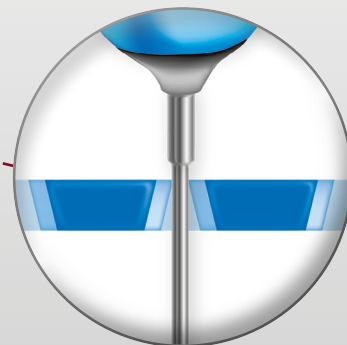
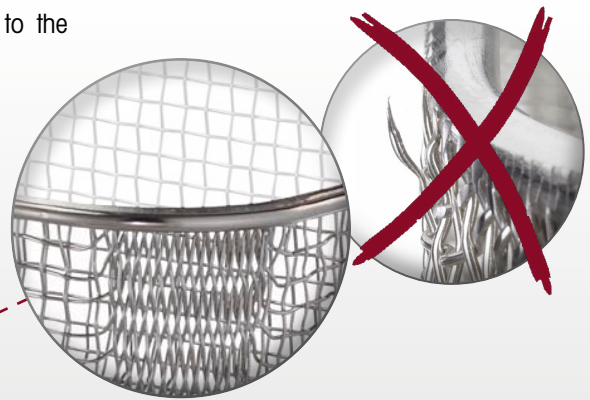

Minimal contact surface as a result of the special design of the silicone mounts.

Basket System

Easy handling and configuration

System view with
Universal perforated basket 2 (33002)
and Universal perforated basket 5 (33005)

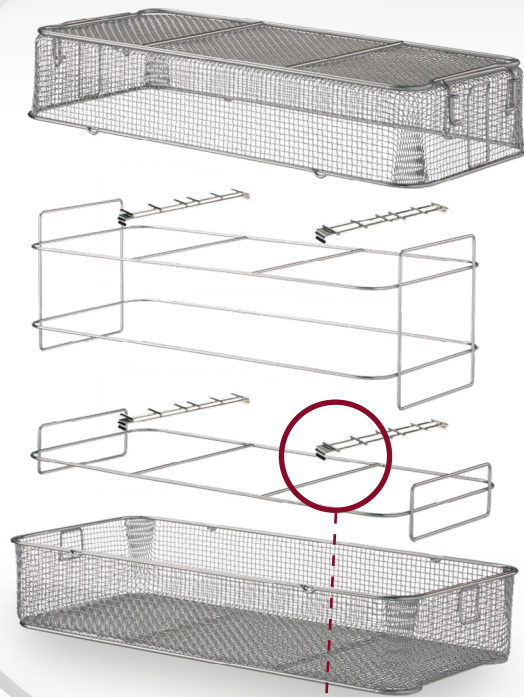



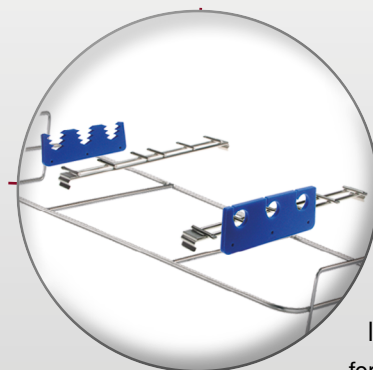
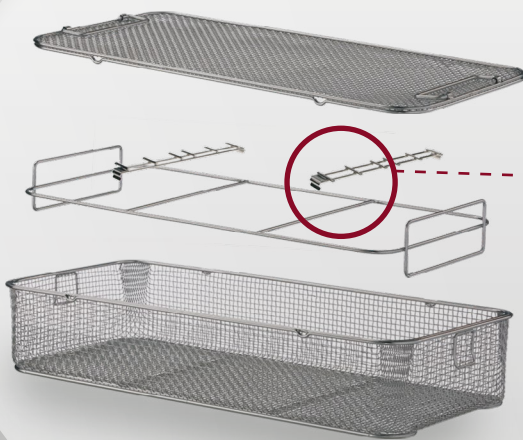

System view with
Universal perforated basket 1 (33001)
and Universal perforated basket 3 (33003)

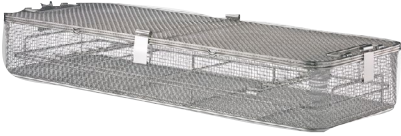
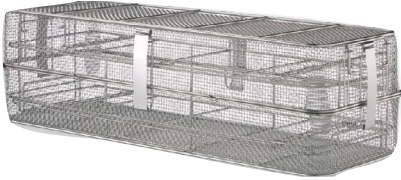

Instrument holder
for perforated bas-
ket are based on the
instrument diameter and should
be ordered separately.

Basket System

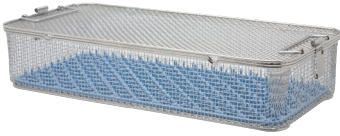
Ordering information

Illustration	Description	Product no.
 <p>Universal perforated basket 1 with instrument separator (2)</p>	<p>Holds: Instrument and accessories, for sterilization (steam and low-temperature), storage and transport, with instrument separator (2), inner dimensions (WxHxD): 709 x 88 x 259 mm, outer dimensions (WxHxD): 732 x 117 x 282 mm</p>	<p>33001</p>
 <p>Universal perforated basket 2 with instrument separator (4)</p>	<p>Holds: Instrument and accessories, for sterilization (steam and low-temperature), storage and transport, with instrument separator (4), inner dimensions (WxHxD): 709 x 186 x 259 mm, outer dimensions (WxHxD): 743 x 200 x 282 mm</p>	<p>33002</p>
 <p>Universal perforated basket 3 mit Instrumentensteg (2)</p>	<p>Holds: Instrument and accessories, for sterilization (steam and low-temperature), storage and transport, with instrument separator (2), inner dimensions (WxHxD): 513 x 95 x 233 mm, outer dimensions (WxHxD): 538 x 117 x 250 mm</p>	<p>33003*</p>
 <p>Universal perforated basket 4</p>	<p>Holds: Instruments, for sterilization (steam and low-temperature), storage and transport, inner dimensions (WxHxD): 513 x 95 x 233 mm, outer dimensions (WxHxD): 538 x 117 x 250 mm</p>	<p>33004*</p>
 <p>Universal perforated basket 5 mit Instrumentensteg (4)</p>	<p>Holds: Instrument and accessories, for sterilization (steam and low-temperature), storage and transport, with instrument separator (4), inner dimensions (WxHxD): 513 x 184 x 233 mm, outer dimensions (WxHxD): 549 x 200 x 250 mm</p>	<p>33005*</p>

* suitable for standard container

Basket System

Accessories

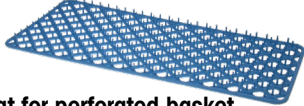











Illustration	Description	Product no.
 <p>Instrument mat for perforated basket</p>	Storage and transport, for holding instruments during sterilization (steam and low-temperature), dimensions (W x D): 500 x 226 mm	33301
 <p>Instrument separator for perf. basket</p>	Holds: instruments, storage and transport, for holding instruments during sterilization (steam and low-temperature)	33302
 <p>Fastening set for perforated basket</p>	Storage and transport, for holding instruments during sterilization (steam and low-temperature)	33303
 <p>Perforated basket instrument holder</p>	Storage and transport, for aligning the axial position of instruments during sterilization (steam and low-temperature)	33304
 <p>Instrument holder for perforated basket</p>	closed 3 parts, for instruments with outer diameter, storage and transport, for holding instruments during sterilization (steam and low-temperature), outer dimensions (WxHxD): 109 x 40 x 5 mm	33305
 <p>Instrument holder for perforated basket</p>	open 3 parts, storage and transport, for holding instruments during sterilization (steam and low-temperature), outer dimensions (WxHxD): 109 x 35 x 5 mm	33306
 <p>Instrument holder for perforated basket</p>	closed 5 parts, storage and transport, for holding instruments during sterilization (steam and low-temperature), outer dimensions (WxHxD): 109 x 35 x 5 mm	33307
 <p>Instrument holder for perforated basket</p>	open 5 parts, storage and transport, for holding instruments during sterilization (steam and low-temperature), outer dimensions (WxHxD): 109 x 35 x 5 mm	33308
 <p>Instrument holder for perforated basket</p>	closed 7 parts, storage and transport, for holding instruments during sterilization (steam and low-temperature), outer dimensions (WxHxD): 109 x 35 x 5 mm	33309
 <p>Instrument holder for perforated basket</p>	open 7 parts, storage and transport, for holding instruments during sterilization (steam and low-temperature), outer dimensions (WxHxD): 109 x 25 x 5 mm	33310

Illustration	Description	Product no.
<p>Locking pin for mesh basket</p>  <p>required for this: Knurled nut for perforated basket</p>	<p>for holding instruments during sterilization (steam and low-temperature), storage and transport</p>	<p>64019127</p> <p>64082153</p>
 <p>Set of fixing rings</p>	<p>for universal perforated basket, for holding instruments during sterilization (steam and low-temperature), storage and transport, 1x Ø 90,0 x 3,0 mm, 1x Ø 116,0 x 3,0mm, PACK=2 PCS</p>	<p>74002311</p>
 <p>Perforated basket for small parts</p>	<p>Holds: Small parts, for sterilization (steam and low-temperature), storage and transport, inner dimensions (WxHxD) : 109 x 20 x 109 mm, outer dimensions (WxHxD) : 128 x 40 x 121 mm</p>	<p>33006</p>

Reprocessing cycle



spirit of excellence



Subject to modifications. Please note that some products may not be available in all countries. Please always take note of the information that is provided with the product. For more detailed information, please consult with your contact partner or directly with Richard Wolf GmbH.

J609er221021

Richard Wolf GmbH
Pforzheimer Straße 32
75438 Knittlingen, Germany

Tel.: +49 7043 35-0
Fax: +49 7043 35-4300
info@richard-wolf.com

Co-CEOs:
Jürgen Pfab
Jürgen Steinbeck

Trade Register: Mannheim HRB 510031
VAT no.: DE144521586
Tax no.: 48020/00171

find us on
Social Media
richard-wolf.com



richard-wolf.com