

Imaging

1 *ENDOCAM® Camera Systems*

2 *Accessories / Storage Media*

3 *Couplers*

4 *ZeroWire Ultra*

5 *Monitors*

6 *Video Printers*

7 *Light Sources*

8 *Light Cables / Adapters*

9 *Documentation*

10 *Carts*

ENDOCAM® Logic 4K



The ENDOCAM Logic Family offers the new definition of sharp with the ENDOCAM Logic 4K Camera Controller. The image data is processed in full 4K UHD bandwidth with no upscaling. The result is a pin-sharp display of endoscopic images enabling even the most delicate structures to be distinguished.

The digital camera head for the 4K system impresses with improved ergonomics – thanks to more compact construction it is now smaller and more lightweight. PANOVIEW ULTRA telescopes have been specially tailored to the requirements of 4K resolution and they deliver improved marginal luminance and homogeneous image brightness.

The ENDOCAM Logic 4K Camera Controller is truly a platform solution - compatible with all ENDOCAM Logic camera heads, ENDOCAM Logic camera head green*, digital endoscopes, and the RIWO D-URS.

*Suitable for ICG/NIR fluorescence imaging

ENDOCAM® Logic 4K Camera Controller



Digital ENDOCAM Logic 4K Camera Controller for pin-sharp 4K visualization. Optimally tailored system with 4K camera head, PANOVUE ULTRA Telescopes, 55", 32" and 27" 4K medical monitors and ENDOLIGHT LED 2.2 Light Source with **dialog** Technology.

- Brilliant 4K UHD resolution of 3840 x 2160px and 4096 x 2160px
- Storage of high-resolution HD images and videos on USB storage media (optional)
- A member of the ENDOCAM Logic Family - also suitable for existing, compatible application components and camera heads with lower resolution
- Future-proof investment because updates can always be obtained with USB port
- ICG/NIR capable*
- Compatible with RIWO D-URS disposable ureteroscope using an adapter (5525410)*
- Very user-friendly as a result of clinically developed presets for different disciplines; effortless storage of customizable presets
- High-level of flexibility as a result of easy adjustment of all signal outputs to connected systems (e.g., monitors, documentation systems and video routing)
- Intuitive menu navigation on the integrated touchscreen
- Input of patient data using USB keyboard
- dialog** Technology:
 1. Regulation of the connected **dialog**-capable ENDOLIGHT LED 2.2 Light Source for optimum illumination
 2. Monitor overlay of the most important parameters of other devices (e.g., pressure details, preset flow, residual gas display)
- Direct printing possible

*Available with software version 2.0.9 or higher

ENDOCAM Logic 4K Camera Controller Bundle **552530115**











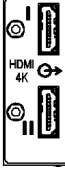



consisting of: ENDOCAM Logic 4K Camera Controller (5525301), manual remote control (5525401), USB flash drive 8 GB (56540028), HDMI/HDMI cable lockable 3.0 m (103847), power cable (N710171)

Accessories: RIWO D-URS Adapter for ENDOCAM Logic Camera Controller.....**5525410**



ENDOCAM® Logic 4K

Camera Controller - Signal Overview

	<p>Output</p> 	<p>Two HDMI (High Definition Multimedia Interface) 4K outputs required for transmission of full 4K UHD resolution.</p>	  
	<p>Output</p> 	<p>HDMI (High Definition Multimedia Interface) is compatible with the standard graphical interface DVI (Digital Visual Interface) as used by most monitors and documentation systems. Adapter cables are supplied for maximum flexibility. Appropriate cables can be locked at all HDMI outputs for a particularly secure connection.</p>	 
	<p>Output</p> 	<p>3G-SDI is a high professional signal standard. It even exceeds the resolution of the official HDTV standards (1080i / 720p) as it can transmit a higher bit-rate in progressive full HDTV 1080p. 3G-SDI can transfer camera signals over wide distances, longer than 5 meters.</p>	 
 	<p>Input</p> 	<p>An additional 3G-SDI input offers the option to display an additional image source as a small preview on the main monitor = picture-in-picture (PiP). Size and location inside the main picture can be adjusted to suit individual requirements.</p>	

Technical Data

ENDOCAM® Logic 4K

Camera Controller

Type	5525301	
Protection rating EN 60601-1 (UL 2601-1 / CSA C22.2 NO.601.1 - for USA)	1	
Electromagnetic Compatibility (EEC)	EN 60601-1-2 / IEC 601-1-2	
Classification according to Directive 93/42/EWG	Class 1	
Classification	CF	
Degree of protection against ingress of liquids	IP 20 (not protected)	
Operating conditions	+10°C to +40°C	
USB connector (device front for external storage media)	USB 2.0 (FAT32/NTFS format)	
File format of saved pictures / videos	JPEG, TIFF (max. 1920 x 1200) MPEG4 (max. 1920 x 1080/60/P)	
Remote output	2x 3.5 mm stereo jack	
Resolution (HDMI output)	Adjustable in user menu SXGA 1280 x 1024/60/P (aspect 5:4) HDTV 1920 x 1080/60/P (aspect 16:9) WUXGA 1920 x 1200/60/P (aspect 16:10) 4K 3840 x 2160/60/P (aspect 16:9) 4096 x 2160/60/P (aspect 17:9)	
Resolution (3G-SDI output)	Adjustable in user menu 1280 x 720/50/P 1920 x 1080/50/I 1280 x 720/60/P 1920 x 1080/60/I 1920 x 1080/50/P 1920 x 1080/60/P	
Resolution picture-in-picture input (max. 3G-SDI)	1280 x 720/50/P 720 x 576/50/I 1280 x 720/60/P 720 x 486/60/I 1920 x 1080/50/P 1920 x 1080/50/I 1920 x 1080/60/P 1920 x 1080/60/I	

Technical Data

ENDOCAM® Logic 4K

Camera Controller

Type	5525301
Brightness control	Automatic shutter regulation + automatic gain
White balance, range of color temperature	2300 K to 7000 K
Dimensions touchscreen (w x h)	144 x 78.24 mm
Power consumption	120 VA
Noise Level	34 dB to max. 48 dB
Operating mode	Continuous operation
Current rating	max. 1.2 A
IP protection rating	IP 20
Power supply	100 - 240 Vac, 50 / 60 H
Weight	6.0 kg
Dimensions (w x h x d)	300 x 120 x 416 mm

3 Chip 4K Camera Head ENDOCAM® Logic 4K



The ENDOCAM Logic 4K Camera Head generates 4K UHD resolution obtained from 3 sensors. This enables the recorded image data to be directly processed.

- ❑ 3x 1/3 inch CMOS image sensors, aspect ratio 16:9
- ❑ More ergonomic handling as a result of smaller and more lightweight design
- ❑ C-Mount for connection to multitude of couplers
- ❑ Digital image processing and digital signal transmission
- ❑ 2 programmable camera head buttons with up to 4 functions
- ❑ Camera cable can be exchanged by technicians in the hospital

ENDOCAM Logic 4K Camera Head

3 Chip, cable length 3 m **85525942**

Technical Data

ENDOCAM® Logic 4K

3 Chip 4K Camera Head

Type	85525942
Control	2 programmable camera head buttons
Lens thread	C-Mount
Sensor size	3x 1/3" CMOS, 16 : 9
Light sensitivity (max. gain)	< 0.7 Lux / F1.8 @ 50% Level
Signal-to-noise ratio	52 dB (ISO 15739)
Brightness control (shutter time)	1/50 to 1/56250 sec.
Degree of protection against penetration of liquids	IP X7
Weight of camera head (without cable)	121 g
Housing dimensions (w x h)	40 x 47 mm
Length - without cable and anti-kink protection	102 mm

ENDOCAM® Logic 4K

Compatible with all components and camera heads of the ENDOCAM Logic Family



- ❑ ENDOCAM Logic 4K 3 Chip Camera Head
- ❑ ENDOCAM Logic Camera Head green
- ❑ ENDOCAM Logic HD 3 Chip Camera Head
- ❑ ENDOCAM Logic HD 1 Chip Camera Head
- ❑ ENDOCAM Logic HD Pendual Camera Head
- ❑ Flexible Sensor Ureteroscope "COBRA Vision"
- ❑ Flexible Sensor Utereteroscope "BOA Vision"
- ❑ Flexible Sensor Cystoscope "MAMBA Vision"
- ❑ RIWO D-URS Disposable Ureteroscope

ENDOCAM® Logic 4K

Complete Overview

ENDOCAM Logic 4K Camera Controller Bundle	552530115
consisting of:	
ENDOCAM Logic 4K camera controller (5525301), manual remote control (5525401), USB flash drive 8 GB (56540028), HDMI/HDMI cable lockable 3.0 m (103847), power cable (N710171)	
ENDOCAM Logic 4K Camera Head	
3 Chip, cable length 3 m	85525942
RIWO Fixed Lenses, C-Mount	
14 mm	85261144
24 mm	85261244
RIWO Zoom Lens, C-Mount	
13 - 29 mm	85261504
ENDOzoom Coupler, C-Mount	
16 - 34 mm	87-10-2020
RIWO Angular Lenses, C-Mount	
14 mm	5257141
17 mm	5257171
ENDOLIGHT LED 2.2 Bundle	51640011
consisting of:	
ENDOLIGHT LED 2.2 (5164001), patch cable, RJ45 SFTP, 0.5 m (72325378) and power cable (N710171), 100-240 V~, 50/60 Hz	
Fusion Fiber Light Cable Bundle, Ø 5.0 mm,	806550301
consisting of:	
adapter projector-side (8095.07), adapter endoscope-side (809509) and Fusion fiber light cable (80655030), 3.0 m	
4K Medical Monitors	
27" Sony (Richard Wolf-Branded) Bundle	LMD-X2705N_BNDL
consisting of:	
27" Sony (Richard Wolf-Branded) Monitor (LMD-X2705N), Monitor Cover (N800406), Thumb Screws (N900692), Power Supply (AC-300MD)	
31" Foreseeson (FSN)	FS-P3102D
32" Sony (Richard Wolf-Branded) Bundle	LMD-X3200N_BNDL
consisting of:	
32" Sony (Richard Wolf-Branded) Monitor (LMD-X3200N), Monitor Cover (53700031), Thumb Screws (N900692), Power Supply (AC-300MD)	
55" Sony (Richard Wolf-Branded)	LMD-X550NB
Mini Cleanboard USB Wipeable USB keyboard incl. mousepad	5365.7363
Digital Color Printer SONY UP-DR80MD	5365.855
UPC-R81MD Print Pack	5365.8551

System green

ENDOCAM Logic camera head green

for ICG/NIR Applications



- ❑ Compatible with ENDOCAM Logic 4K (5525301) and ENDOCAM Logic HD (5525106) camera controllers*
- ❑ 2 programmable camera head buttons with up to four functions
- ❑ Autoclavable
- ❑ Digital image processing and signal transmission with dedicated powerful NIR sensor for high fluorescence sensitivity
- ❑ Also suitable for use in white light endoscopy
- ❑ Integrated lens (f=24 mm)
- ❑ Snap-on lock mechanism for connection to endoscopes

**Available with software version 2.0.9 or higher*

ENDOCAM Logic camera head green..... 85525812

2 Chip, cable length 3 m

Technical Data

System green

ENDOCAM Logic camera head green

Type	85525812
Sensor size	1/3" CMOS
Control	2 programmable camera head buttons
Focal length of integrated lens	24 mm
Operating conditions	+10°C to +30°C, 20% to 85% rel. humidity, atmospheric pressure: 700 hPa to 1060 hPa
Degree of protection against the ingress of moisture	IPX7
Camera head weight (without cable)	196 g
Housing dimensions (W x H) - without cable and anti-kink protection	48 x 48 x 136 mm
Camera head length (without cable)	136 mm
Cable length	3 m
Cable outlet	30°

ENDOCAM® Logic HD



ENDOCAM Logic HD defines a new generation of digital cameras to generate endoscopic pictures for diagnosis and therapy. Pre-programmed user presets - which can be selected easily on the integrated touch-screen - make usage of the camera's extensive operation features very easy.

Various HD output signals performed in the highest actual available standards (3G-SDI and HDMI).

Digital camera heads and chip-on-the-tip sensor endoscopes produce their images by 3CCD-, 1CCD- or CMOS sensor technology. In this way they can be designed very accurately and highly specialized for the intended use.

The integrated USB storage records pictures and videos in HD quality.

ENDOCAM® Logic HD Camera Controller



- ❑ Storage of high-resolution HD images and videos on USB storage media (optional)
- ❑ Digital signal processing
- ❑ Platform solution with access to the ENDOCAM Logic family of camera heads, digital endoscopes and the RIWO D-URS*
- ❑ Firmware updates via USB connection at any time
- ❑ ICG/NIR capable*
- ❑ Compatible with RIWO D-URS disposable ureteroscopy using an adapter (5525410)*
- ❑ User friendly: Pre-programmed presets (tested during clinical applications) for different disciplines; Self-made adjustments can be stored and individually named very easily
- ❑ Maximum flexibility: The output resolution of all signals can be matched individually to the connected systems (monitor, documentation system, video routing installation, etc.)
- ❑ Patient data can be entered with USB Keyboard
- ❑ Best print results in combination with medical printer SONY UP-DR80MD (P/N: 5365.855)
- ❑ **dialog** Technology:
 1. Automatic regulation of connected ENDOLIGHT LED 2.2 Light Source for optimum illumination
 2. Monitor display of most important parameters of other devices (pressure, flow, remaining amount of gas, etc.)

*Available with software version 2.0.9 or higher

ENDOCAM Logic HD Camera Controller Bundle.....55251061

consisting of: ENDOCAM Logic HD Camera Controller (5525106), manual remote control (5525401), USB flash drive 8 GB (56540028), CAN-BUS terminator (5590989), HDMI/DVI-D cable lockable 3.0 m (103843), power cable (N710171) and DVD license (64360816)











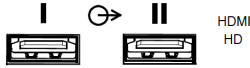

Accessories: RIWO D-URS Adapter for ENDOCAM Logic Camera Controller.....5525410



ENDOCAM® Logic HD

Camera Controller - Signal Overview

ENDOCAM

	<p>Output</p> 	<p>HDMI (High Definition Multimedia Interface) is compatible to the standard graphic interface DVI (Digital Visual Interface). Adapter cables for maximum flexibility are available. HDMI connections of ENDOCAM Logic HD can be locked to establish a very safe connection.</p>	 
	<p>Output</p> 	<p>3G-SDI is the highest professional signal standard available. It even exceeds resolution of the official HDTV standards (1080i / 720p) as it can transmit a higher bit-rate in progressive full HDTV 1080p. 3G-SDI is the preferred signal for transmissions greater than 5 meters.</p>	 
 	<p>Input</p> 	<p>An additional 3G-SDI input offers the option to display an additional image source as a small preview on the main monitor picture of the camera = picture-in-picture (PIP). Size and location inside the main picture can be adjusted to suit individual requirements.</p>	 

Technical Data

ENDOCAM® Logic HD

Camera Controller

Type	5525106	
Safety class EN 60601 (UL 2601-1 / CSA C22.2 NO.601.1 - for USA)	1	
Electromagnetic Compatibility (EMC)	EN 60601-1-2 / IEC 601-1-2	
Classification according to Directive 93/42/EWG	Class 1	
Classification	CF	
Degree of protection against penetration of liquids	IP 20 (not protected)	
Operating conditions	+10°C to +40°C	
USB connector (device front for external storage media)	USB 2.0 (FAT32 format)	
File format of saved pictures / videos	JPEG, TIFF / MPEG4 (*) (1920 x 1080) (file extension *.ts)	
Remote output	2x 3.5 mm stereo jack	
Resolution (HDMI output)	Adjustable in user menu SXGA 1280 x 1024/60/P (aspect 5:4) HDTV 1920 x 1080/60/P (aspect 16:9) WUXGA 1920 x 1200/60/P (aspect 16:10)	
Resolution (3G-SDI output)	Adjustable in user menu 1280 x 720/50/P 1920 x 1080/50/I 1280 x 720/60/P 1920 x 1080/60/I 1920 x 1080/50/P 1920 x 1080/60/P	
Resolution picture-in-picture input (3G-SDI)	1280 x 720/50/P 1920 x 1080/50/I 1280 x 720/60/P 1920 x 1080/60/I 1920 x 1080/50/P 1920 x 1080/60/P	

Technical Data

ENDOCAM® Logic HD

Camera Controller

Type	5525106
Brightness control	Automatic shutter regulation + automatic gain
White Balance, range of color temperature	2300 K up to 7000 K
Power consumption	100 VA
Noise Level	34dB bis / up to max. 48dB
Duty cycle	Continuous operation
Power rating	max. 1.0 A
IP Protection	IP 20
Power supply	100 - 240V~ (a.c.), 50 / 60 Hz
Weight	6.0 kg
Dimensions (w x h x d)	300 x 120 x 416 mm

ENDOCAM® Logic HD *lite* Camera Controller



ENDOCAM Logic HD *lite* is the cost-effective version of the ENDOCAM Logic HD.

- ❑ Highest quality, for an attractive price.
- ❑ It has most of the same features as the ENDOCAM Logic HD Camera Controller (refer to page 21 for details).
- ❑ Compatible with RIWO D-URS disposable ureteroscope using an adapter (5525410)*

**Available with software version 2.0.9 or higher*

ENDOCAM Logic HD *lite* Camera Controller Bundle 55252011

consisting of:

ENDOCAM Logic HD *lite* Controller (5525201), manual remote control (5525401), USB flash drive 8GB (56540028), HDMI / DVI-D cable lockable 3.0 m (103843), power cable (N710171), DVD License (64360816)

Accessories: RIWO D-URS Adapter for ENDOCAM Logic Camera Controller.....5525410



Technical Data



ENDOCAM® Logic HD lite

Camera Controller

Type	5525201
Electromagnetic Compatibility (EMC)	IEC 601-1-2
Medical Device Directive 93/42/EEC	Class 1
Protection rating complying with EN 60601-1 (UL 2601-1; CSA C22.2 no. 601.1 for USA)	1
Classification	CF
Degree of protection against penetration of liquids	IP 20 (not protected)
Operating conditions	+10°C to +40°C
USB connector (device front for external storage media)	USB 2.0 (FAT32 format)
Aspect ratio	JPEG, TIFF
Remote output	2x 3.5 mm stereo jack
Resolution (HDMI output)	Adjustable in user menu SXGA 1280 x 1024/60/P (aspect 5:4) HDTV 1920 x 1080/60/P (aspect 16:9) WUXGA 1920 x 1200/60/P (aspect 16:10)
Brightness control	Automatic shutter regulation + automatic gain
White balance, range of color temperature	2300k to 7000k
Power consumption	100 VA
Duty cycle	Continuous operation
Power rating	max. 1.0 A
Power supply	100 - 240 V~ (a.c.), 50 / 60 Hz
Weight	5.2 kg
Dimensions (w x h x d)	300 x 120 x 416 mm

ENDOCAM® Logic

Camera Controller Comparison

	ENDOCAM Logic HD	ENDOCAM Logic HD <i>life</i>	ENDOCAM Logic 4K
			
	Type	Type	Type
Features	5525106	5525201	5525301
Recording of images onto USB stick (image archive)	●	●	●
Recording of videos onto USB stick (video archive)	●	-	●
Patient data input via USB keyboard	●	●	●
Touchscreen	●	-	●
On-screen display	●	●	●
dialog Technology	●	-	●
Mirroring of images	●	●	●
4K signal processing	-	-	●
ICG/NIR Capable	●	-	●
Compatible with digital endoscopes	●	●	●
Compatible with RIWO D-URS disposable ureteroscope	●	●	●
Picture-in-picture input	●	-	●
Horizontal image flip	●	●	●
Vertical image flip	●	-	●
Diagonal image flip	●	-	●

3 Chip HD Camera Head ENDOCAM® Logic HD



- ❑ 3x 1/3 inch sensor, 16:9
- ❑ C-Mount for connection to multitude of couplers
- ❑ Digital image processing and digital signal transfer
- ❑ 2 programmable camera head buttons with up to four functions
- ❑ Cable connection 30° angled
- ❑ Camera cable can be exchanged by technician in the hospital

ENDOCAM Logic HD Camera Head

3 Chip, Cable length 3 m **85525922**

Accessories:

RIWO Fixed Lens, C-Mount, f = 14 mm	85261144
RIWO Fixed Lens, C-Mount, f = 24 mm	85261244
RIWO Zoom Lens, C-Mount, f = 13 - 29 mm	85261504
ENDOzoom Coupler, C-Mount, f = 16 - 34 mm	87-10-2020
RIWO Angular Lens, C-Mount, f = 14 mm	5257141
RIWO Angular Lens, C-Mount, f = 17 mm	5257171

Technical Data

ENDOCAM® Logic HD

3 Chip HD Camera Head

Type	85525922
Control	2 programmable camera head buttons
Lens thread	C-Mount
Sensor size	3x 1/3" CCD, 16 : 9
Light sensitivity (max. gain)	< 1 Lux / f = 1.2
Signal-to-noise ratio (normal gain)	14dB
Brightness control	1/50 - 1/12650 sec.
Degree for protection against penetration of liquids	IP X7
Weight of camera head (without cable)	170 g
Housing dimensions (w x h) - without cable and anti-bend protection	43 x 53 mm
Length	105 mm

1 Chip HD Camera Head ENDOCAM® Logic HD



- ❑ 1/3 inch sensor, 16:10
- ❑ C-Mount for connection to multitude of couplers
- ❑ Digital image processing and digital signal transfer
- ❑ 2 programmable camera head buttons with up to four functions
- ❑ Camera cable can be exchanged by technician in the hospital

ENDOCAM Logic HD Camera Head

1 Chip, Cable length 3 m **85525902**

Accessories:

RIWO Fixed Lens, C-Mount, f = 14 mm	85261144
RIWO Fixed Lens, C-Mount, f = 24 mm	85261244
RIWO Zoom Lens, C-Mount, f = 13 - 29 mm	85261504
ENDOzoom Coupler, C-Mount, f = 16 - 34 mm	87-10-2020
RIWO Angular Lens, C-Mount, f = 14 mm	5257141
RIWO Angular Lens, C-Mount, f = 17 mm	5257171

Technical Data

ENDOCAM® Logic HD

1 Chip HD Camera Head

Type	85525902
Control	2 programmable camera head buttons
Lens thread	C-Mount
Sensor size	1/3" CCD, 16 : 10
Light sensitivity (max. gain)	< 0.5 Lux / f = 1.2
Signal-to-noise ratio (normal gain)	-52dB to max. 17dB
Brightness control	1/30 - 1/7594 sec.
Degree for protection against penetration of liquids	IP X7
Weight of camera head (without cable)	95 g
Housing dimensions (w x h) - without cable and anti-bend protection	34 x 36 mm
Length	114 mm

Pendul Camera Head ENDOCAM® Logic HD



- ❑ 1/3 inch sensor, 5 : 4
- ❑ Dual mode operation through twistable camera head body:
1-pendulum head, 2-straight head
- ❑ Integrated coupler f = 17 mm
- ❑ Freely rotating snap-on lock with lock function
- ❑ Digital image processing and digital signal transfer
- ❑ 2 programmable camera head buttons with up to four functions
- ❑ Camera cable can be exchanged by technician in the hospital

ENDOCAM Logic HD Pendul Camera Head

Cable length 3 m 5525933

Technical Data

ENDOCAM® Logic HD

Pendul Camera Head

Type	5525933
Control	2 programmable camera head buttons
Sensor size	1/3" CCD, 5 : 4
Light sensitivity (max. gain)	1.87 Lux / f = 5.1 (integrated)
Signal-to-noise ratio (normal gain)	-52dB to max. 17dB
Brightness control	1/30 - 1/7594 sec.
Degree for protection against penetration of liquids	IP X7
Weight of camera head (without cable)	170 g
Housing dimensions (w x h) - without cable and anti-bend protection	51 x 50 mm
Length	140 mm

RIWO 
D-URS

ENDOCAM D Camera Controller

ENDOCAM



Designed for the RIWO D-URS, the ENDOCAM D is compact, portable and ready for use at the push of a button. Despite its size, the ENDOCAM D offers a brilliant endoscopic image and a multitude of features enhancing convenience and flexibility.

- ❑ Intuitive and easy operation
- ❑ Compact and low profile
- ❑ Multiple video output signals and video formats for added flexibility
- ❑ Image and video documentation on a USB storage device
- ❑ 3 function buttons:
 - Start/Stop Video
 - Image Capture
 - Zoom (3 levels)
- ❑ Ideal supplement to existing systems

ENDOCAM D Camera Controller Bundle.....**55221015**

consisting of:

ENDOCAM D Camera Controller (5522101), HDMI/DVI-D cable lockable 3.0 m (103843), Coaxial Cable Vektor Plus 3.0 m (DZGR-0300-SW-GN), License for Open Source Software (72321911) and Power Cable (N710171)

Recommended accessories:

Manual Remote.....**5525401**

2-Port HDMI 18 GB Bi-Directional Switch**38336**

Technical Data

RIWO >—
D-URS
ENDOCAM D

Camera Controller

Type	
Type of controls	Mechanical buttons
Max. video signal resolution	1920 x 1080 pixels
Brightness control	Automatic shutter control + automatic gain control
Digital zoom	2.5x max.
Operating conditions	+10°C to +40°C, 20% to 85% rel. humidity, atmospheric pressure 700 hPa to 1,060 hPa
Storage, transport, and shipping conditions	-20°C to +60°C, 10% to 90% rel. humidity, atmospheric pressure 700 hPa to 1,060 hPa
Operating mode	Continuous operation
IP rating	IP20
Mains + frequency	100–240 V-, 50/60 Hz
Power consumption	32 V A
Current rating	0.32–0.13 A
Fuse	T 1.25 AH 250 V
Safety	UL 2601-1 / CSA C22.2 No. 601.1 – for USA
EMC	EN/IEC 60601-1-2
Medical device class	Class 1
Classification of applied part	BF
Video outputs	1x 3G-SDI, 1x HDMI
USB port (device front: external storage media)	USB 2.0 (FAT32/NTFS formatting)
Resolution (HDMI output)	SXGA 1280 x 1024p (60 Hz) (5:4) Full HD 1920 x 1080p (60 Hz) (16:9)
Resolution (3G-SDI output)	1920 x 1080p (60 Hz)
Weight	2.3 kg
Dimensions (W x D x H)	200 mm x 240 mm x 67 mm

Cable Accessories

4K Signal Cables

HDMI / HDMI cable

6 ft 409960006

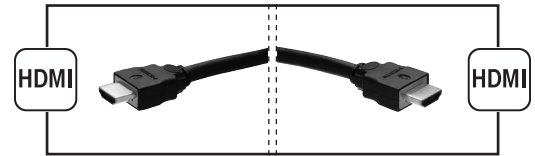

HDMI / HDMI cable, lockable

3.0 m 103847

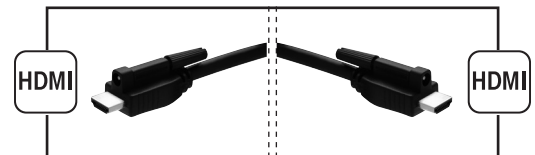

High Definition Signal Cables

DVI-D cable

25 ft 41065.5025

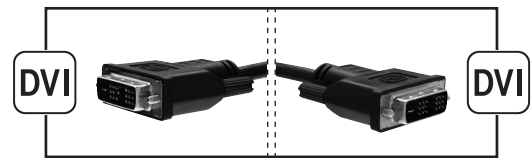

HDMI / DVI-D cable

6 ft 409960016

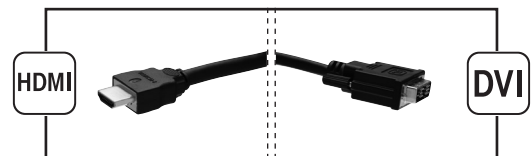

HDMI / DVI-D cable, lockable

3.0 m 103843

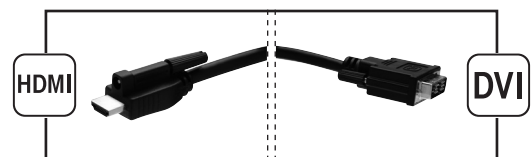

Standard Definition Signal Cables

S-Video cable 5363.17

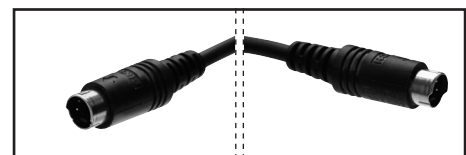

Cable Accessories

Interface Cables

Remote cable

1.5 m, 3.5 mm / 3.5 mm (stereo) **5502.991**

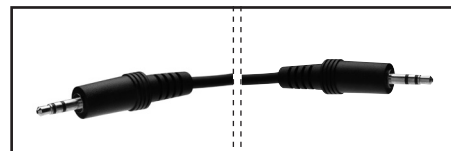

Ethernet cable

2.0 m **103.03**

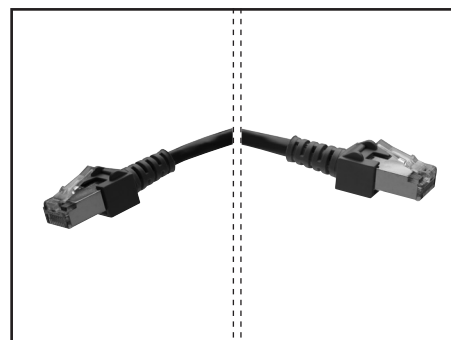

ACCESSORIES/
STORAGE MEDIA

Signal Transmission Cables

Coaxial Cable Vektor Plus 1.0 m.....	DZGR-0100-SW-GN
Coaxial Cable Vektor Plus 2.0 m.....	DZGR-0200-SW-GN
Coaxial Cable Vektor Plus 3.0 m.....	DZGR-0300-SW-GN
Coaxial Cable Vektor Plus 15 m.....	DZGR-1500-SW-GN
Coaxial Cable Vektor Plus 25 m.....	DZGR-2500-SW-GN

Cable Accessories

Power Cables / Other

Device power cable*

0.9 m 31100.922

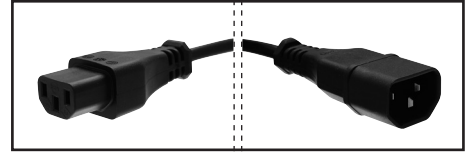

Device power cable*

0.6 m 32114.321

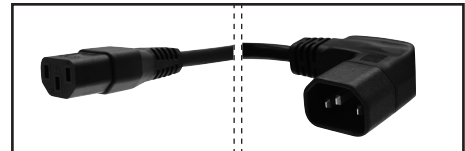

Device power cable*

3.0 m 32114.323

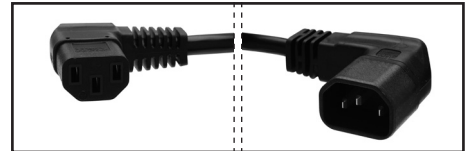

** recommended for use with RIWOmobil OR Cart.*

2-Port HDMI 18GB Bi-Directional Switch.....38336



Xenon lamp module, 300 W 2431.121
(HiLight and X300)



ACCESSORIES/
STORAGE MEDIA

Keyboard
for clinical use

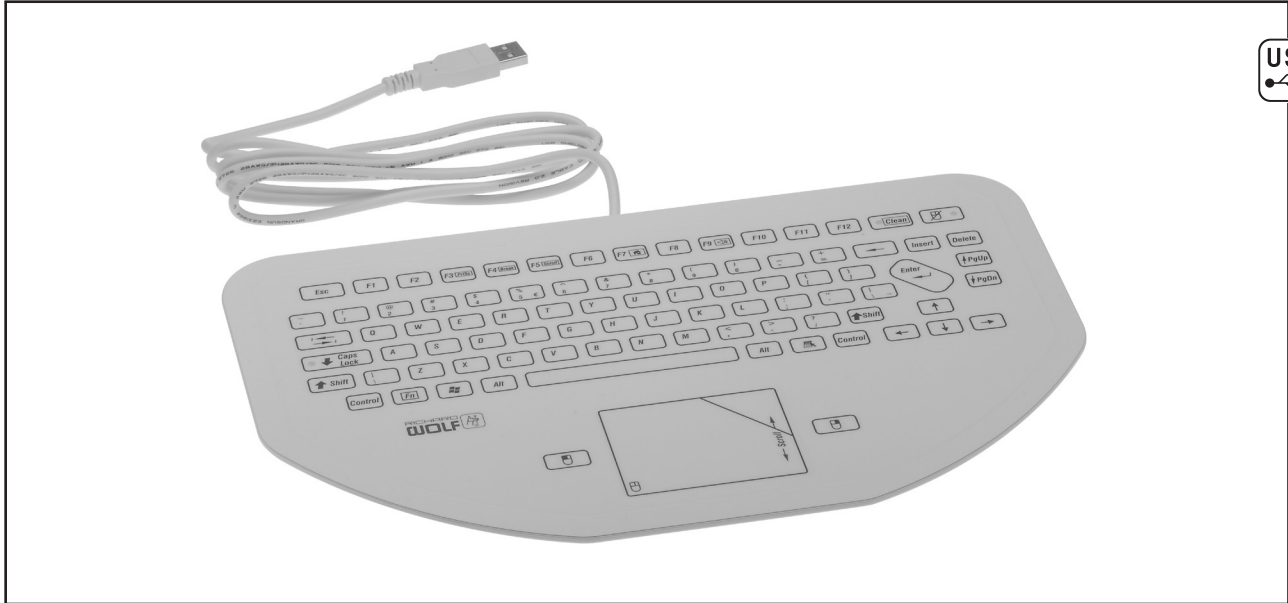

ACCESSORIES/
STORAGE MEDIA

Mini CleanBoard USB **5365.7363**

Washable USB keyboard incl. Mousepad. Integrated magnets on bottom side for better hold. IP65 sealed, resistant against current disinfectants, dimensions (w x h x d): 300 x 22.4 x 180 mm

Accessories/Storage Media

USB flash drives

8 GB,
format: FAT32 **56540028**

4 GB,
format: FAT32 **409960004**



Couplers



RIWO Fixed Lenses, C-Mount

f = 14 mm **85261144**

f = 24 mm **85261244**

- Fixed focal length
- Snap-on lock
- Sterilization: Autoclavable & immersible



RIWO Zoom Lens, C-Mount

f = 13 - 29 mm **85261504**

- Parfocal zoom
- Snap-on lock
- Sterilization: Autoclavable & immersible



RIWO Zoom Lens, C-Mount

f = 13 - 29 mm **5261504**

- Parfocal zoom
- Snap-on lock
- Sterilization: STERRAD® & immersible



ENDOzoom Coupler, C-Mount

f = 16 - 34 mm **87-10-2020**

- Parfocal zoom
- Locking tabs
- Sterilization: Autoclavable & STERRAD® & Steris System 1



RIWO Angular Lenses, C-Mount

f = 14 mm **5257141**

f = 17 mm **5257171**

- Fixed focal length
- Rotatable snap-on lock
- Sterilization: STERRAD® & Immersible

Adapters for RIWO Lenses



Connector (optional)
for endoscope exchange
under sterile conditions **8580.91**
Sterilization: Autoclavable & Immersible

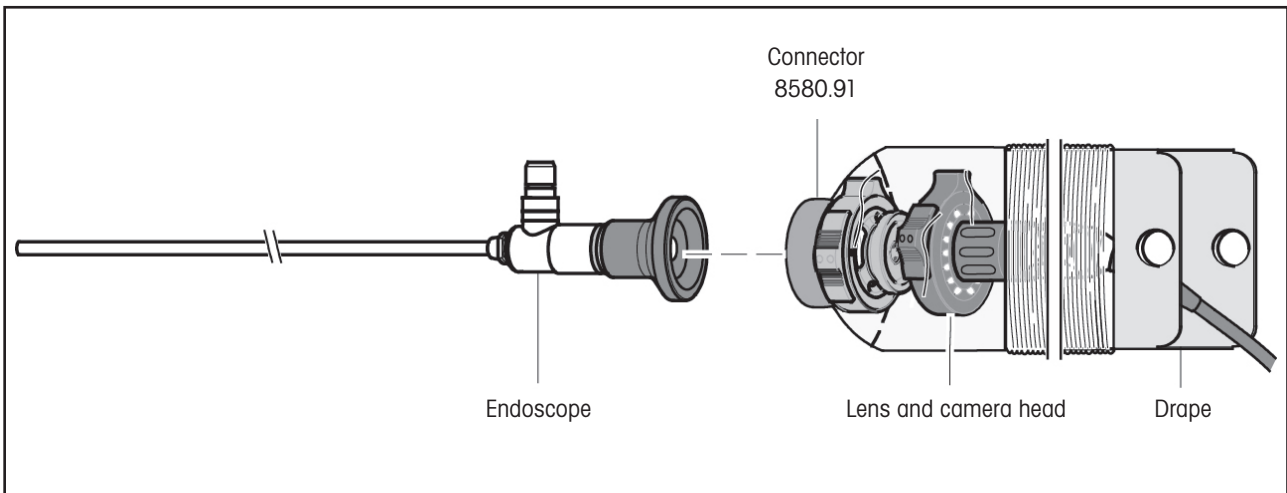

Wireless HDTV Transmitter

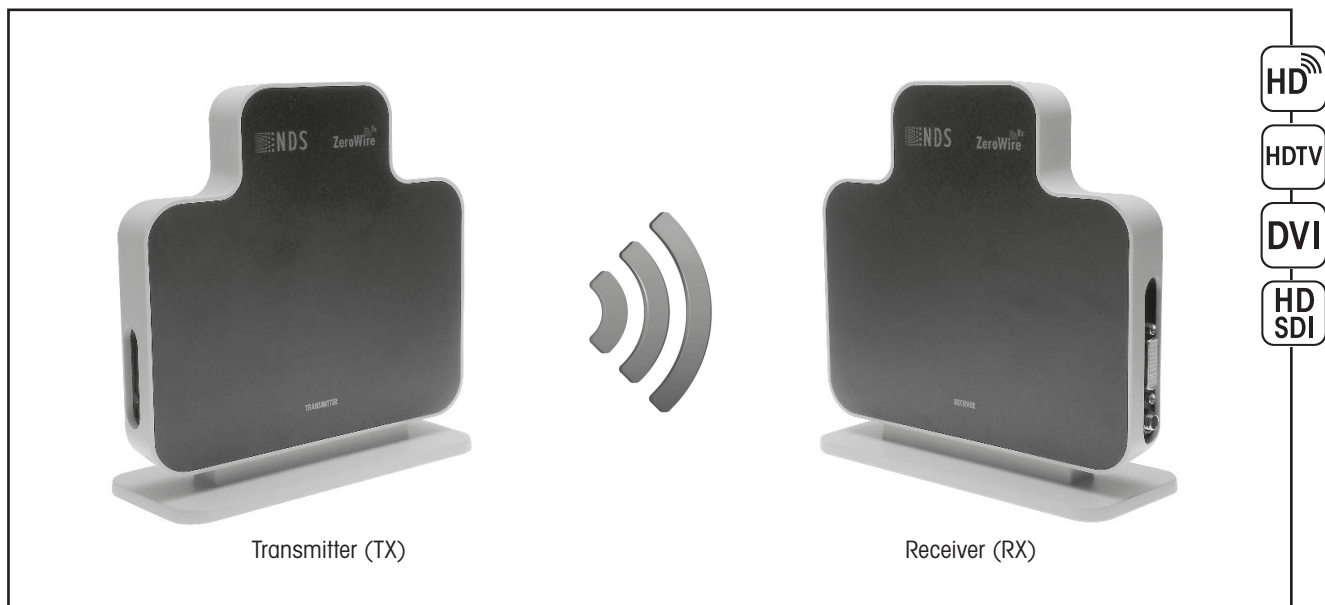

Medical grade wireless video transmission of HDTV video signals in the endoscopic operating room.

- ❑ Improves clinical efficiency and safety by eliminating video cables which are a potential tripping hazard

Ideal applications are:

- ❑ HDTV transmission to:
 - Free positioning of the second monitor. For example, on appropriate mobile stands.
 - Secondary monitor on ceiling supply if normal wiring would be expensive or impractical.
- ❑ Full-HD video in realtime with less than one frame time lag.
- ❑ Ultra-Wide Band (UWB) frequency spectrum, providing a robust wireless link. No interference from other devices.
- ❑ Easy-to-use pairing system makes installation quick and easy.
- ❑ The Transmitter (TX) will accept either a DVI or SDI input.
- ❑ Compatible with ENDOCAM Logic family.

ZeroWire Ultra DVI+SDI Duo TX/RX Bundle 537160045

consisting of:

Wireless HD Video Transfer System, Supplied with: Transmitter, receiver, 2 x power supply,
2 x table stand, 2 x DVI cable, CD including User Manual and Installation Guide

Inputs on transmitter: DVI, 3G-SDI, HD-SDI

Output on receiver: DVI-D

ZEROWIRE Ultra is a registered trademark by NDS Surgical Imaging Corp., San Jose, CA (USA).

Accessories



ZeroWire Ultra Transmitter SDI-DVI53716010

Separate transmitter of Wireless HD Video Transfer System, 3-Channel, consisting of:

Transmitter, 1 x power supply, 1 x bench stand, 1 x DVI cable, 1 x HD-SDI cable, CD including Instruction Manual and Installation Guide. Inputs at transmitter: DVI, 3G-SDI, HD-SDI



ZeroWire Ultra Receiver DVI53716012

Separate receiver of Wireless HD Video Transfer Systems, 3-Channel, consisting of:

Receiver, 1 x power supply, 1 x bench stand, 1 x DVI cable, CD including Instruction Manual and Installation Guide
Output at receiver: DVI-D



ZeroWire Ultra Accessories Bundle 5371.6003

consisting of:

2 x DVI to DVI cable, 2 x VESA mount, SDI cable, Y-adaptor cable



VESA Mount for ZeroWire Ultra 5371.6006

VESA Mount for ZeroWire Transmitter or Receiver for installation at the VESA 100 of LCD monitors.



Power Supply 5371.6007



Table Stand 5371.6005



ZERO WIRE

Technical Data



Common standards	IEC 60601-1, EN 60601-1-2, UL 60601-1, FCC Part 15 Class A
Further standards	FDA Class II, FDA 510(k) Clearance, Japan TELEC 001UWAA1005 and 001UWAA1006
Frequency band	UWB 3.1 GHz bis / up to 4.8 GHz
Data rate	53.3 / up to 480 Mbps
TX to RX range*	30 feet
Compression technology	H.264
System latency	Less than one frame
Signal to interference ratio	128 - bit AES
Interference robustness	up to - 10dBk signal to interference ratio
Bonding of TX / RX pair	Memory-enabled pairing system
Power supply	24 V~ (a.c.)
Power consumption	max. 14 Watt

ZERO WIRE

* The effective range between the transmitter and receiver can vary depending upon the environment in which the product is operating. Follow the guidelines specified in the product's installation guide to achieve optimum performance and maximum Tx to Rx (transmitter to receiver) range.

55" Sony Richard Wolf-Branded 4K Medical Monitor LMD-X550NB



55" Sony Richard Wolf-Branded 4K Medical Monitor LMD-X550NB

4K resolution, a-Si TFT Active Matrix LCD,
OptiContrast Panel (IPS), CD-ROM, instructions

- Special customized presets for Richard Wolf
- OptiContrast Panel™ with 520 cd/m² and contrast
- Slim enclosure with narrow bezel for a wider display area
- Excellent picture quality even if displaying zoomed images

Recommended accessories:

Monitor mount

VESA 200x400 **32116472**

Protective Cover for Monitor 55" **53700055**

RIWomobil OR Cart with Premium Electrics

Isolating transformer 100-120Vac **3211601355**



MONITORS

Technical Data

55" Sony Richard Wolf-Branded 4K Medical Monitor

Type	LMD-X550NB	
Panel characteristics		
Monitor size	55 inch (138.78 cm)	
Resolution / Aspect ratio	3840 x 2160 / 16 : 9	
Max. brightness	520 cd/m ²	
Contrast ratio	1400 : 1	
Angle of view	178° H / 178° V	
Panel technology	IPS	
Backlight	LED	
Equipment		
IP protection	IPX2	
VESA mount	VESA 200 x 400	
Accessories included	Power cable, User Manual monitor (CD-ROM) 4x M6 x 12mm screws	
Power supply		
Input voltage	100 - 240 Vac, 50/60 Hz, 2.1 - 1.0A	
Max. power consumption	290 W	
Regulatory compliance		
Safety	US/CA: UL 60601-1, CAN/CSA-C22.2 No. 60601-1, EU: EN 60601-1	
Electromagnetic compatibility (EMC)	US/CA: FCC Part 15 Class A, ICES-003 Class A, EU: EN 60601-1-2, AU: EN 55011 Class B, J: VCCA Class A	
CB Certification	IEC 60601-1, IEC 60065	
FD&C Act FDA MDD (EU)	Class II Medical Device Class I Medical Device	
Interfaces		
Inputs / Outputs	4K: in: 1x HDMI or 4x BNC out: 4x BNC HD: in: 5x BNC (3G-/HD-/SD-SDI) out: 5x BNC (3G-/HD-/SD-SDI) in: 1x DVD-D out: 1x DVI-D	
Dimensions and weight		
Weight monitor	35.2 kg	
Dimensions monitor (w x h x d)	1264.6 x 771.5 x 85.5 mm	

32" Sony Richard Wolf-Branded 4K Medical Monitor LMD-X3200N



32" Sony Richard Wolf-Branded 4K Medical Monitor.....LMD-X3200N

32" Sony Richard Wolf-Branded 4K Medical Monitor Bundle.....LMD-X3200N_BNDL

consisting of:

32" Sony Richard Wolf-Branded 4K Medical Monitor (LMD-X3200N), Protective Cover for Monitor (53700031), Thumb Screws (N900692), Power Supply (AC-300MD)

**Power Supply (AC-300MD) is not included with LMD-X3200N. It must be ordered separately.*

- Special customized presets for Richard Wolf
- High brightness OptiContrast Panel™
- Slim enclosure with narrow bezel for a wider display area
- Excellent picture quality even if displaying zoomed images

Recommended accessories:

Power SupplyAC-300MD
Protective Cover for Monitor53700031
Monitor Stand5370.0190

Technical Data

32" Sony Richard Wolf-Branded 4K Medical Monitor

Type	LMD-X3200N	
Panel characteristics		
Monitor size	32 inch (81.28 cm)	
Resolution / Aspect ratio	3840 x 2160 / 16 : 9	
Max. brightness	500 cd/m ²	
Contrast ratio	1000 : 1	
Angle of view	178° H / 178° V	
Panel technology	IPS	
Backlight	LED	
Equipment		
IP protection	IPX2	
VESA mount	VESA 100 x 100	
Accessories included	User Manual monitor (CD-ROM), User Manual, 4x M4 x 12mm screws	
Power supply		
Input voltage	100 - 240 Vac, 50/60 Hz	
Power supply	External power supply	
Max. power consumption	63 W	
Regulatory compliance		
Safety	US: UL (ANSI/AAMI ES60601-1), CA: cUL (CAN/CSA-C22.2 (No. 60601-1)), EU: CE (MDR) (EN 60601-1 + 60601-1-2)	
Electromagnetic compatibility (EMC)	US: FCC (Class A Digital Device), CA:ISED (ISED Class A Digital Device), EU: EN 60601-1-2	
CB Certification	IEC 60065, IEC 60950-1, IEC 60601-1	
FD&C Act FDA MDD (EU)	Class I Medical Device FD&C Act: Class I	
Interfaces		
Inputs / Outputs	4K: in: 1x HDMI oder/or 4x BNC out: 4x BNC HD: in: 5x BNC (3G-/HD-/SD-SDI) out: 5x BNC (3G-/HD-/SD-SDI) in: 1x DVD-D out: 1x DVI-D	
Dimensions and weight		
Weight monitor	11.8 kg	
Weight external power supply	1.5 kg	
Dimensions monitor (w x h x d)	754 x 476 x 79 mm	
Dimensions external power supply (w x h x d)	245 x 150 x 58 mm / Cable length between monitor and power supply: 2.8 m	

Foreseeson (FSN) 31" 4K Medical Monitor FS-P3102D

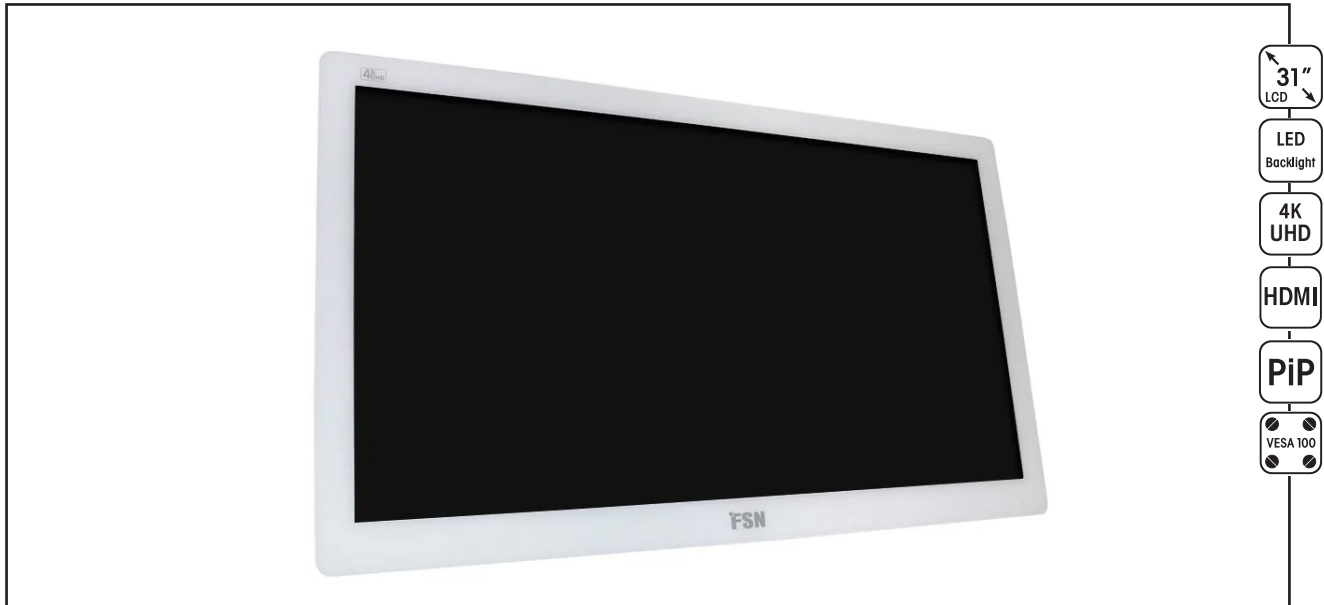

31" FSN 4K Medical Monitor **FS-P3102D**

- ❑ 4K (4096 x 2160 pixels), at 60 Hz, in the surgical suite
- ❑ Bonded front filter for higher brightness and contrast ratio
- ❑ State-of-the-art surgical visualization
- ❑ Ready, out of the box, for advanced digital OR installations
- ❑ Flush-front glass surface, fast and easy to clean
- ❑ Slim profile and narrow bezel for a streamlined design

Recommended accessories:

Protective Cover for Monitor **53700031**
Monitor Stand **5370.0190**

MONITORS

Technical Data

31" Foreseeson (FSN) 4K Medical Monitor

Type	FS-P3102D	
Panel characteristics		
Monitor size	31 inch (78.906 cm)	
Resolution / Aspect ratio	4096 x 2160 / 17 : 9	
Max. brightness	350 cd/m ²	
Contrast ratio	1500 : 1	
Angle of view	R/L 178°, U/D 178°	
Panel technology	TFT	
Backlight	LCD	
Equipment		
IP protection	IP33	
VESA mount	100 x 100; 100 x 200	
Accessories included	User Manual, AC-DC Adaptor, AC Power Cord; DP cable, HDMI cable, DVI-D cable, Screw BH M4 x 14 for mounting	
Power supply		
Input voltage	AC/DC Adaptor (AC 100-240V, DC 24V/6.6A)	
Power supply	External power supply	
Max. power consumption	90 W	
Interfaces		
Inputs / Outputs	Inputs: 1 x HDMI 2 x DP 1.2 (SST) 1 x DVI (single link)	Outputs: 1 x DVI (single link) 1 x DP 1.2 (SST)
Dimensions and weight		
Weight monitor	9.2 kg	
Dimensions monitor (w x h x d)	773.1 x 453.6 x 75.5 mm	

27" Sony Richard Wolf-Branded 4K Medical Monitor LMD-X2705N



27" Sony Richard Wolf-Branded 4K Medical Monitor LMD-X2705N

27" Sony Richard Wolf-Branded 4K Medical Monitor Bundle LMD-X2705N_BNDL

consisting of:

27" Sony Richard Wolf-Branded 4K Medical Monitor (LMD-X2705N), Protective Cover for Monitor (N800406), Thumb Screws (N900692), Power Supply (AC-300MD)

**Power Supply (AC-300MD) is not included with LMD-X2705N. It must be ordered separately.*

- Very bright panel with 800 cd/m² and 1000:1 contrast
- 4K resolution with 3840 x 2160 pixels
- Slim housing with narrow edge for optimum use of the display
- Direct power supply or optionally via an external power supply unit
- Optimized color matching for Richard Wolf ENDOCAM
- Automatic switching to second monitor input if the connection to input 1 is interrupted

Recommended accessories:

Power Supply AC-300MD

Protective Cover for Monitor N800406

Monitor Stand 5370.0190

MONITORS

Technical Data

27" Sony Richard Wolf-Branded 4K Medical Monitor

Type	
Panel Characteristics	LMD-X2705N
Screen diagonal	27"
Resolution / Aspect ratio	3840 x 2160 / 16:9
Background lighting	LED
Display colors	1.073.000.000
Contrast	1000 : 1
Max. luminance	800 cd/m ²
Response time	4 ms
Angle of view	178" H / 178" V
Equipment	
Video input / output (SD)	In: 1x HDMI 2.0b, 1x DVI-D, 1x 3G/HD/SD-SDI, 2x display port Out: 1x DVI-D, 1x 3G/HD/SD-SDI, 1x display port
VESA mount	VESA 100 x 100
IP rating	IPX5 (front), IPX2 (all other sides)
Power supply	
Mains + frequency	100 - 240 VAC, 50/60 Hz
Power consumption	149 VA
Current rating	1.5 to 0.7 A
Power supply unit	Internal power supply unit
Regulatory standards	
Safety	US: UL (ANSI_AAMI ES60601-1, FCC (Class A Digital Device) Canada: cUL (Can/CSA-C22.2 (No. 60601-1)), ISED (ISED Class A Digital Device) EU: CE (MDD) (EN 60601-1 + EN60601-1-2)
CB certification	IEC60065, IEC62368-1, IEC60601-1
Medical device class	MDD (EU): Class I Medical Device; FD&C Act FDA: Class II Medical Device
Dimensions and weight	
Weight	8.8 kg
Dimensions (w x h x d)	658.8 x 426.8 x 80 mm

21.5" LCD Medical Monitor MDRAP21ELXACRW3



21.5" LCD Medical MonitorMDRAP21ELXACRW3

21.5" LCD Medical Monitor, widescreen format 16:9, use as video LCD

21.5" LCD Medical Monitor Bundle MDRAP215

consisting of:

21.5" LCD Medical Monitor (MDRAP21ELXACRW3), HDMI/DVI Cable lockable 3.0 m (103843), Thumb Screws (N900692)

- HDTV capable, compact widescreen LCD with 21.5" screen diagonal
- LED-backlight, Trueflat IPS panel
- Outstanding color reproduction
- DVI input for high-definition video signals

Recommended accessory:

Monitor Stand

VESA 100 x 100 / 75 x 75

Color: White, RAL 9016 **OP-MED-TF-R9016**



Power Supply **MDS-060AAS24**

Technical Data

21.5" LCD Medical Monitor

Type	MDRAP21ELXACRW3	
Standards	According EN 60601-1, following the provisions of 93/42ECC Medical Device directive(s) Class 1 Medical Device	
Audio	Integrated speakers and stereo amplifier	
Resolution / Aspect ratio	1920 x 1080 (Resolution 1920x1200 can be displayed) / 16 : 9	
Contrast ratio	1000 : 1	
Brightness	250 cd / m ²	
Response time	14 ms (grey to grey)	
VESA mount	VESA 100 x 100	
Angle of view	178° (H), 178° (V)	
Signal Input (HD)	1x DVI-D 1x VGA	1x DisplayPort (1 x Audio in, 3.5 mm Stereo)
Video input / output (SD)	-	
Accessories included	DVI cable 1.8 m (1), VGA cable 2 m (1), DisplayPort cable 1.8 m (1), External power supply (1), Power supply (1), Audio cable (1)	
Power supply		
External power supply	100 - 250 V~ (a.c.), 50 / 60 Hz	
Operation power	+24 V (d.c.), 2.5 A	
Max. power consumption	85 W	
Dimensions and weight		
Weight	approx. 5.7 kg without stand	
Dimensions (w x h x d)	537 x 384 x 236 mm without stand	

Digital USB Printer Sony UP-DR80MD



- ❑ Medical grade USB printer
- ❑ Enhanced documentation of findings including endoscopic generated pictures in HD quality
- ❑ Laminating technology which coats each print with a protective layer enables long-term storage
- ❑ High speed printing: one page within approx. 72 seconds
- ❑ Compact size and stylish design
- ❑ Ideal for placement on a RIWOmobil cart or at a nurse workstation

Digital Color Printer SONY UP-DR80MD 5365.855

Medical sublimation thermal printer

Letter-size

Interface: Hi-speed USB (2.0), resolution 301 dpi

UPC-R81MD Print Pack 5365.8551

For medical USB printer SONY UP-DR80MD

consisting of:

Paper roll for 50 prints (2 pcs.) and ink ribbon (2 pcs.)

Supplied with printer:

USB Printer Cable 5365.8552

Technical Data

Digital USB Printer

Sony UP-DR80MD

Type	5365.855
Common standards	IEC 60601-1, IEC 609950
Printing Method	Sublimation Thermal Printing
Resolution	301 dpi
Print size (Print pack: 5365.8551)	Letter size, 215.9 x 279.4 mm (8.5 x 11 inches)
Printing time	Letter size: approx. 72 seconds
Paper tray capacity	One paper roll for 50 prints
Interface	Hi-speed USB (2.0)
Power supply	100 - 240 V~ (a.c.), 50 / 60 Hz
Power consumption	3.4 to 1.4 A (max. 340 Watt)
Weight	approx. 11.5 kg
Dimensions (w x h x d)	317 x 207 x 425 mm

Color Video Printer Sony UP-25MD



- ❑ High picture quality
- ❑ High resolution and excellent color reproduction
- ❑ HD input via Component HD (3x BNC, max. 1080i)
- ❑ S-Video and Composite input
- ❑ Full size image, 1, 2 or 4-images per page

Color Video Printer SONY UP-25MD 5365.250

Color video printer for analog video signals
incl: CD-ROM, Instruction manual (PDF - 21 languages),
Paper tray, stopper and cleaning cartridge
(paper roll and one color ribbon included)

UPC-21L Color Printing Pack 5365.0211

For color video printer SONY UP-25MD
consisting of:
200 paper sheets, 4x print cartridge each for 50 prints

Technical Data

Color Video Printer

Sony UP-25MD

Type	5365.250
Common standards	EN 60601-1-1, EN 55022 (Class B), CE symbol 93/42/EWG-mdd
Printing Method	Color Sublimation Thermal Printing
Resolution	423 dpi
Print size (Print pack: 5365.0211)	Full 5 x 3 ¾ inches
Printing time	approx. 29 seconds
TV standard	PAL / NTSC
Power supply	100 - 120 V / 100 - 240 V~ (a.c.), 50 / 60 Hz
Signal input / output	Video, S-Video, RGB HDTV: Component (Y/Pb/Pr) (3x BNC)
Weight	approx. 5.5 kg
Dimensions (w x h x d)	212 x 98 x 398 mm

LED Light Source ENDOLIGHT **LED 2.2**



The ENDOLIGHT LED 2.2 light source has a life span of approximately 30,000 operating hours resulting in saved service costs. In addition, LED technology produces homogenous illumination while using approximately 80% less electricity than xenon technology.

- ❑ High Light Power
 - The light power is comparable to a 300 watt xenon light source, which means it can be used for most endoscopic interventions.
- ❑ Safe
 - **Safe Start function:** ENDOLIGHT LED 2.2 immediately returns to normal operation when very brief interruptions to the operating voltage occur. If the interruption lasts longer than 5 seconds, the unit switches to Safe Start mode. Light energy is only emitted again after the user re-activates the system.
- ❑ **dialog** Technology
 - ENDOLIGHT LED 2.2 communicates through **dialog** Technology with the ENDOCAM Logic family of camera control units and is always optimally regulated to match the operating scene. Switching the light on and off can also be controlled by the Logic camera head buttons.
- ❑ Multiport light socket
 - Rotatable light cable connector for direct connection of light cables from Richard Wolf, Olympus, Storz or ACMI.

ENDOLIGHT LED 2.2 Bundle **51640011**

consisting of:

ENDOLIGHT LED 2.2 (5164001), patch cable, RJ45 SFTP, 0.5 m (72325378) and power cable (N710171), 100-240 V~, 50/60 Hz

LED Light Source ENDOLIGHT **LED 2.1**



The ENDOLIGHT LED 2.1 light source has a life span of approximately 30,000 operating hours resulting in saved service costs. In addition, LED technology produces homogenous illumination while using approximately 80% less electricity than xenon technology.

- ❑ High Light Power
 - The light power is comparable to a 300 watt xenon light source, which means it can be used for most endoscopic interventions.
- ❑ Safe
 - **Safe Start function:** If an interruption occurs, the device switches to standby mode. Illumination resumes only after being switched on again by the user.
- ❑ Brightness control
 - The amount of light is determined using a touch panel on the front of the unit.
- ❑ Wolf light socket
 - The light socket is optimized for light cables supplied by Richard Wolf.

ENDOLIGHT LED 2.1 Bundle **51630011**

consisting of:

ENDOLIGHT LED 2.1 (5163001) and power cable (N710171), 100-240 V~, 50/60 Hz

Technical Data

ENDOLIGHT **LED_{2.2}**

ENDOLIGHT **LED_{2.1}**

Type	5163001/5164001
Protection class in conformity with EN 60601-1	1
Electromagnetic compatibility (EMC)	EN 60601-1-2 / IEC 601-1-2
Medical Devices Directive 93/42 EEC	Class 1
Degree of protection against the ingress of liquid	IP 20 (not protected)
Classification	CF
Noise level	25 dB(A)
Power supply	100 - 240 V~ (a.c.), 50 / 60 Hz
Power consumption	150 VA
Current rating	1.1-0.6 A
Color temperature	6500 K
Brightness control	0 - 100%
Working life of LED illuminant (according to the manufacturer)	30,000 h
Illuminant	1x High Power LED
Cooling technology	Passive heat pipe
Operating mode	Continuous operation
Operating conditions	+10°C to + 40°C, 30% to 75% rel. humidity
Storage and transportation conditions	-20°C to + 60°C, 10% to 90% rel. humidity
Weight	LED 2.1: 9.6 kg / 21.1 lbs LED 2.2: 10.5 kg / 23 lbs
Dimensions (w x h x d)	LED 2.1: 300 x 160 x 421 mm LED 2.2: 300 x 160 x 421 mm

LED light source
System green
ENDOLIGHT LED_{green}



- Easy operation - select white light or ICG/NIR illumination with a simple press of a button
- Light output comparable to a 300W xenon light source
- Reduced service and operating costs as a result of extended lifespan of latest LED technology (up to 15,000 hours)
- **dialog** Technology - automatic adjustment of light intensity in conjunction with ENDOCAM Logic HD & 4K camera controllers

LIGHT SOURCES

ENDOLIGHT LEDgreen Bundle.....51650025

consisting of:

ENDODLIGHT LEDgreen (5165002), patch cable, RJ45 SFTP, 0.5 m (72325378) and power cable (N710171)

Recommended accessories:

Foot control rockerswitch.....2030.105

Technical Data

System green

ENDOLIGHT LED_{green}

Type	5165002
Illuminant	2x high-power LED
Working life of LED illuminant	15,000 h
Brightness in Lumen	1,400 lm
Light output compared to xenon in W	300 W
Color temperature	8000 K
Brightness control	0 - 100%
Noise level	30 dB(A)
Operating mode	Continuous operation
Operating conditions	+10°C to +40°C, 20% to 75% rel. humidity, atmospheric pressure 700 hPa to 1060
Supported light cables	Wolf
IP rating	IP20
Cooling technology	Passive heatpipe
Mains + frequency	100-240 VAC, 50/60 Hz
Power consumption	225 VA
Power rating	1.5-0.6 A
EMC	EN 60601-1-2 / IEC 60601-1-2
Medical device class	Class 1
Classification	CF
Weight	10.3 kg
Dimensions (W x H x D)	300 x 160 x 424 mm

LED Light Source ENDOLIGHT LED II



The ENDOLIGHT LED 1.1 light source has a life span of approximately 30,000 operating hours resulting in saved service costs. In addition, LED technology produces homogenous illumination while using approximately 80% less electricity than xenon technology.

- ❑ High Light Power
 - The ENDOLIGHT LED 1.1 can replace a 180 watt xenon light source. This means it can be used for most endoscopic interventions.
- ❑ Safe
 - Automatic dimming of the light-cable socket if the light cable is removed.
- ❑ Low noise
 - The ventilation concept of the ENDOLIGHT LED Series is supported by a very low-noise fan which is virtually inaudible. This significantly reduces the noise level in the operating room.
- ❑ Brightness control
 - The amount of light is determined using the knob on the front panel of the unit.
- ❑ Wolf light socket
 - The light socket is optimized for light cables supplied by Richard Wolf.

ENDOLIGHT LED 1.1 Bundle **51600115**

consisting of:

ENDOLIGHT LED 1.1 (5160011) and power cable (N710171), 100-240 V~, 50/60 Hz

Technical Data

ENDOLIGHT **LED II**

Type	5160011
Protection class in conformity with EN 60601-1	1
Electromagnetic compatibility (EMC)	IEC / EN 60601-1-2
Medical Device Directive 93 /42 EEC	Class 1
Protection against penetration of liquids	IP 20 (unprotected)
Classification	CF
Noise level	25dB(A)
Power supply	100 - 240 V~ (a.c.), 50 / 60 Hz
Power consumption	110 - 120 VA
Current consumption	0.5 - 1.2 A
Color temperature	6500K
Brightness control	0% - 100%
Lamps	1 x High Power LED
Working life of LED	min. 30,000 h
Operating mode	Continuous operation
Operating conditions	+10°C to +40°C
Dimensions (w x h x d)	300 x 120 x 421 mm
Weight	8.5 kg

LED Rover IV Light Source



The battery-powered LED Rover IV is used to illuminate the site of surgery during endoscopic procedures. This portable light source clicks directly onto the light post of a Richard Wolf endoscope for a quick and easy connection. Operated by a simple pushbutton switch and powered by rechargeable batteries, the Rover IV is a user-friendly, compact alternative to conventional light sources and light cables.

- ❑ Compact, portable design eliminates the need for a standard light source and light cable
- ❑ Clicks directly onto the light post of a Richard Wolf endoscope for a quick, intuitive connection
- ❑ Rechargeable batteries offer up to 2.5 hours of illumination per charge

LED Rover IV Portable Light Source Bundle..... 41040000455

consisting of:

3 watt LED Rover IV light source (4104000040),
 [2x] 18650 Lithium Ion Rechargeable Battery (I3000227),
 and Intelligent AC Charger (I3000216)

Technical Data

LED Rover IV Light Source

Type	41040000455
Lamp Type	LED
Color Temperature	5000K (nominal)
Battery	Lithium Ion 18650 3.7V
Battery Discharge Time	~ 2.5 hours
Dimensions	5.1" L x 1.12" diameter (at LED housing)
Weight	5.0 oz with battery

Fiber Light Cable with Color Identification

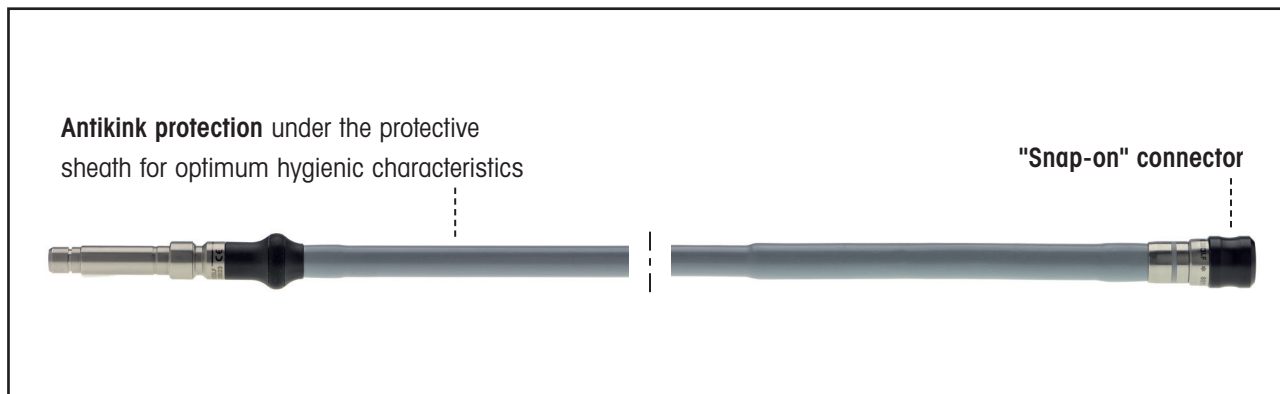

- ❑ High-performance fiberglass materials made in Germany
- ❑ Fast "snap-on" precision connection between endoscope and light cable
- ❑ Designed for a large number of usage cycles with steel antikink protection
- ❑ Uniform color code for light cable and endoscope
- ❑ Appropriate adapters make the light cable compatible with light sources and endoscopes from different manufacturers





Innovative color coding system

The innovative color coding system from **RICHARD WOLF** allows matching diameters to be fitted quickly and securely. This unique form of identification avoids errors in matching up components. The color ring indicates at a glance whether the fiber-bundle diameter of the light cable fits the endoscope.

ø 1.6 mm	blue
ø 2.5 mm	green
ø 3.5 mm	orange
ø 5.0 mm	grey



Fiber Light Cable with Color Identification

Fiber Light Cable Bundle	Color identification endoscope-side	∅ Fiber bundle and color identification	Length	Fiber Light Cable without adapter	Complete bundle
				Type	Type
 <p>Fiber Light Cable bundle consisting of: Fiber Light Cable, adapter projector-side (8095.07) and adapter endoscope-side (809509)</p>		1.6 mm blue	3.0 m	80661630*	806616301
		2.5 mm green	3.0 m	80662530*	806625301
		3.5 mm orange	3.0 m	80663530*	806635301

* The light cables can also be ordered without adapters. We supply adapters for connecting to products from other manufacturers separately.

fusion Fiber Light Cable

High-temperature resistant

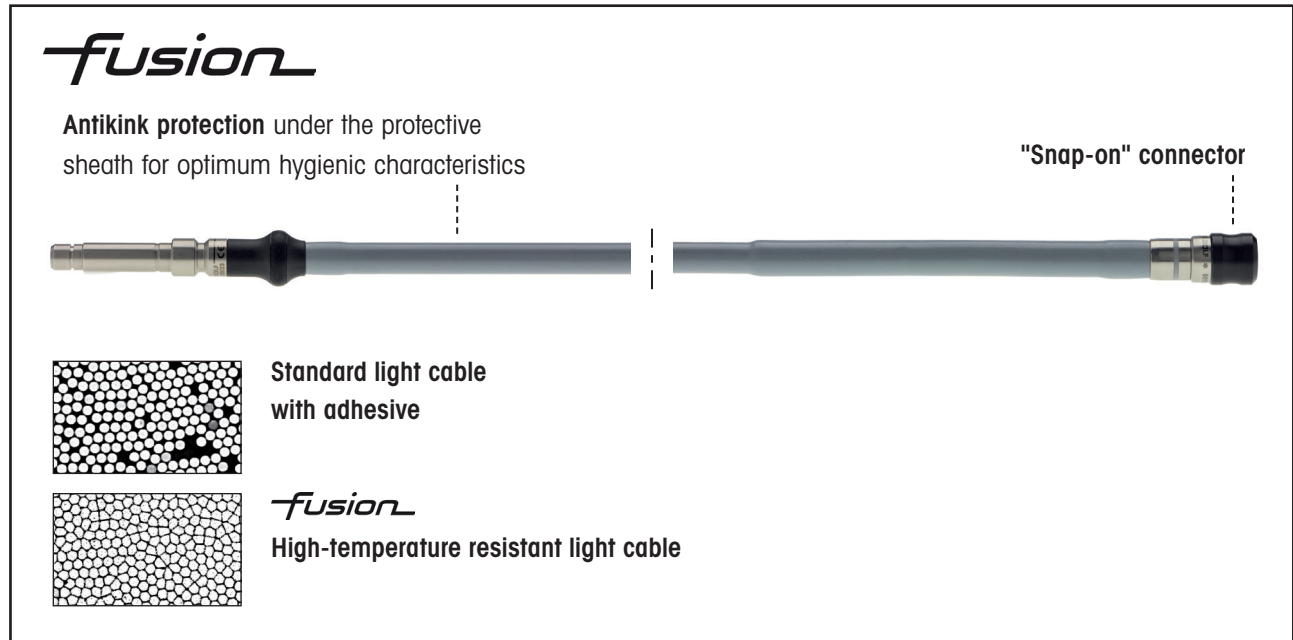

High-power light sources need *fusion*. The fused glass fibers on the light-source side of the light cable create maximum temperature resistance and 20% higher transmission. *fusion* light cables are a particularly rewarding investment and meet the highest standards for endoscopic illumination.

- ❑ More light through *fusion*
- ❑ High-performance fiberglass materials made in Germany
- ❑ Fast "snap-on" precision connection between endoscope and light cable
- ❑ Designed for a large number of usage cycles with steel antikink protection
- ❑ Uniform color code for light cable and endoscope
- ❑ Appropriate adapters make the light cable compatible with light sources and endoscopes from different manufacturers



Innovative color coding system

The innovative color coding system from **RICHARD WOLF** allows matching diameters to be fitted quickly and securely. This unique form of identification avoids errors in matching up components. The color ring indicates at a glance whether the fiber-bundle diameter of the light cable fits the endoscope.



Fusion Fiber Light Cable

High-Temperature resistant

<i>Fusion</i> Fiber Light Cable Bundle	Color identification endoscope-side	∅ Fiber bundle and color identification	Length	Fiber Light Cable without adapter	Complete bundle
				Type	Type
 <p>Fiber Light Cable bundle consisting of: Fiber Light Cable, adapter projector-side (8095.07) and adapter endoscope-side (809509)</p>		5.0 mm grey	3.0 m	80655030*	806550301

* The *Fusion* light cables can also be ordered without adapters. We supply adapters for connecting to products from other manufacturers separately.

Adapters

for RICHARD WOLF Light Cables

Connection with Fiber Light Cable (RICHARD WOLF) to light sources and endoscopes (other manufacturers)

Light source from other manufacturer

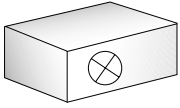



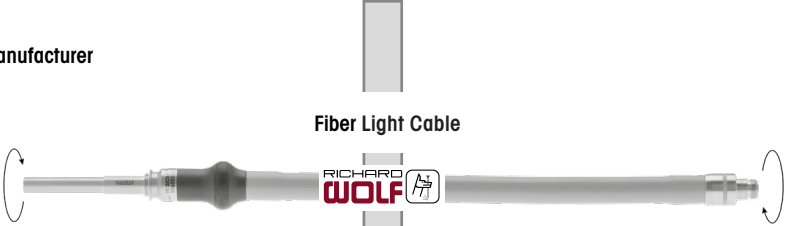

Fiber Light Cable

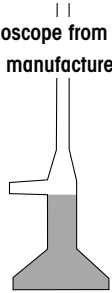

Endoscope from other manufacturer



Light source made by:	Adapter on projector side	Adapter on endoscope side	Endoscope made by:
Storz	fits directly	 807002	ACMI + Circon without adapter
Olympus	 8096.811		Storz without adapter
Stryker	 8095.07*		Olympus without adapter
* Standard in the bundle		 807001	Stryker without adapter
			ACMI + Circon
			Storz
			Olympus
			Stryker

Adapters

for RICHARD WOLF Light Cables

Connection with Fiber Light Cable (other manufacturer) to light sources and endoscopes (RICHARD WOLF)

Light source



Fiber Light Cable

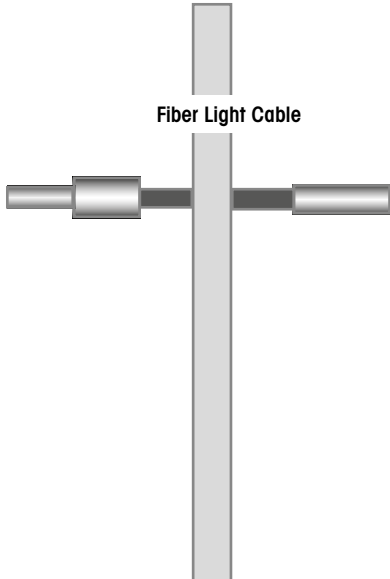

Endoscope

Wolf Adapter 8095.00

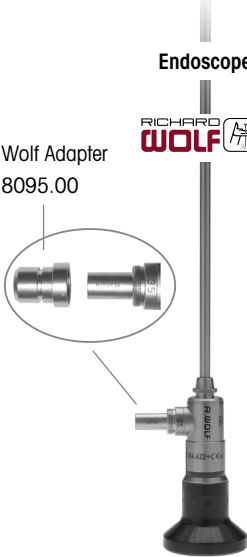





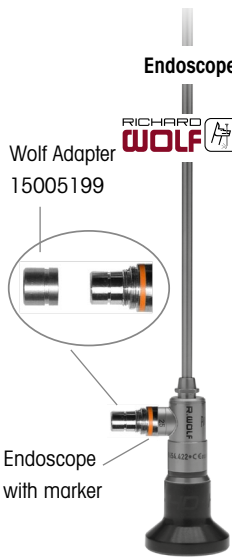

Endoscope

Wolf Adapter 15005199

Endoscope with marker



Adapter on projector side	Fiber Light Cable made by:	Adapter on endoscope side (without identification rings)	Adapter on endoscope side (with identification rings)
	Storz	 8088.00	 808801
	Olympus (standard)	 8088.80	808801
	Olympus WA032...A	 8088.81	
	ACMI + Circon	 8087.00	fits directly
	Stryker (clip-on)		
	Stryker (screw-on)		 808801

ADAPTERS

Evolution4K Digital Recording System



- ❑ With one touch, simultaneously records 4K video and captures still images
- ❑ Integrated 12.7 cm touch LCD screen provides intuitive menu navigation and quick setting changes
- ❑ Work list function saves time by allowing cases to be added before they start
- ❑ Records to internal hard drive and two USB 3.0 drives at the same time
- ❑ Fulfills IT security standard by HIPAA compliance according to appropriate user management, system logging and data encryption. (HIPAA: Health Insurance Portability and Accountability Act to ensure the protection of patient data and health data).
- ❑ Printing via USB or network printer
- ❑ 1 TB internal storage captures up to 20 hours of 4K UHD surgical footage.
- ❑ DICOM integration included: DICOM Worklist for automatic patient data import, DICOM Store for media storage.
- ❑ DICOM transfer to archive: Automatic or manual activation, immediate transfer of the media or after closing the case.
- ❑ iOS wireless application (MedXStream Plus™) for streaming, live still images, recording 4K video (via USB), surgical records and media review.

Evolution4K Digital Recording System **EVO4K130**

Includes:

Evolution4K Digital Recording System, user manual download card, 6-ft. medical grade power cable, AC/DC converter, 6.5-ft HDMI cable, two 6-ft. 3.5 mm trigger cables, 7-ft. ethernet cable, 6-ft. USB A to micro USB B cable, 64 GB USB drive, GL iNet Wireless Router, and GL iNet Installation Pictorial

Optional Accessory:

Universal Integration Engine Software (HL7 Broker) **UIE100**

Technical data

Evolution4K Digital Recording System

Type	EV04K130
Camera / video input resolutions	4K & 4K UHD: 4096x2160p & 3840x2160p, 50/60Hz, HD: 1080p, 1080i, 720p
Video file format	AVCHD H.264 encoding .mp4 file format
Still file format	JPEG, PNG
Video inputs	1x HDMI 2.0
Video outputs	1x HDMI 2.0 loop through / pass through
Internal hard drive capacity	1 TB
Outputs for external touchpanels	VGA, DP++, HDMI (only 1 utilized at a time)
Ethernet ports	2x
Power supply	1 AC/DC medical grade power supply
Remote input	1x 3,5 mm record, 1x 3,5 mm capture
USB 3.0	2x front side , 4x rear side
Dimensions (W x H x D)	210 x 107 x 247 mm
Weight	2.72 kg (6 lbs.)

RIWomobil OR Cart



The RIWomobil OR Cart has the following features:

- ❑ Rear panel and integrated cable duct
- ❑ 3 shelves (width 370mm), 2 with variable adjustment
- ❑ 4 twin swivel castors, 2 with dual-function lock (direction lock/freewheel/total lock)
- ❑ Side extrusions made of aluminum with interfaces to swivel-arm assembly and attachment of comprehensive accessories
- ❑ Color: White, RAL 9016
- ❑ Dimensions (W x H x D): 720 x 1518 x 700 mm

RIWomobil

OR Cart

The latest generation of **RIWomobil** is a compact multifunctional system.

The objective is to provide support for an efficient, ergonomically structured OR Workstation and integrate functional and professional features.

The **RIWomobil OR Cart** offers the following advantages:

❑ **Quality and investment value**

- All components have been designed for long life and robust strength. For example, the powder-coated shelves have been designed as trays to enhance stiffness and to provide a stable platform for equipment positioned there.

❑ **Safety**

- RIWomobil OR Cart is a Class 1 medicinal product and is in conformity with the 93/42 EEC Directive.
- All mechanical and electrical components are subject to a continuous process of quality control, as you would expect from a manufacturer certified in conformity with DIN ISO 13485.
- The swivel-arm combinations have been tested for load capacity and tilt stability.
- Effective castor brakes ensure stable positioning of the cart.
- Optionally, transport locks optimize stable positioning for electromedical equipment (only R. Wolf) when the cart is being wheeled around the hospital.

❑ **Ergonomic design**

- The position of the monitor can be adjusted on the RIWomobil OR Cart to meet the needs of the OR team.
- Height-adjustable shelves and cart handles can be individually adjusted.
- Large, easy-roll twin swivel castors with direction lock facilitate positioning and steering the cart.

❑ **Design**

- The configuration and dimensions are optimally tailored to the equipment design of Richard Wolf.

RIWomobil OR Cart Bundle **3211601355**

consisting of:

RIWomobil OR Cart, CO₂ bottle holder (2x), keyboard drawer, swivel arm, central arm adapter, drawer, shelf (2x), lateral monitor mount (VESA 75/100), spiral hose, IV pole, screws, transport locks (2x), remote mount, USB plate

RIWomobil

Swivel Arm

The swivel arm has the following features:

- ❑ VESA 100 mount
- ❑ Integrated cable duct
- ❑ Mechanical catch
- ❑ Swivel range 340°. The position of the swivel range can be individually defined during assembly.
- ❑ Tough powder-coated finish in white (RAL 9016)
- ❑ The length dimension describes the effective length between the swivel interfaces

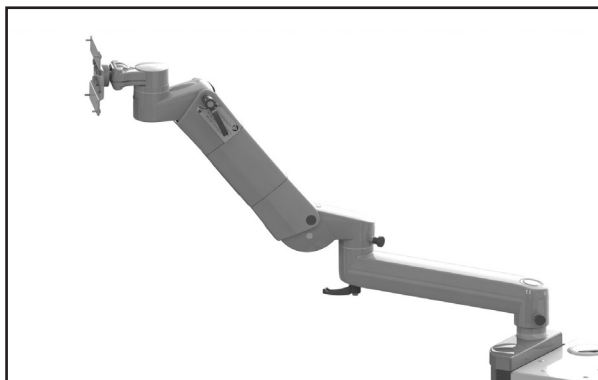

This two-part swivel arm is ideal for the large main monitor.

Flexion Port **32116093**

93 cm for aluminum extrusion

Two-part swivel arm with effective length of 93 cm.

Load capacity: 8-12 kg



Adapter for side arm assembly **32116473**



Adapter for central arm assembly **32116474**

RIWomobil

Accessories

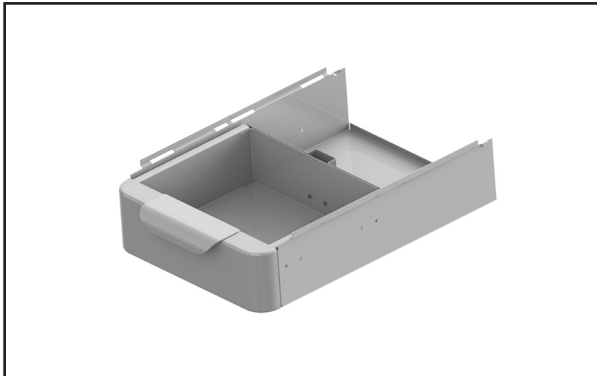

Drawer short, incl. pocket for

power supply 32116414

storage space for external power
supplies accessible from the back.

Inside dimensions of the drawer

(W x D x H): 307 x 276 x 100 mm,

Assembly in production of RIWomobil

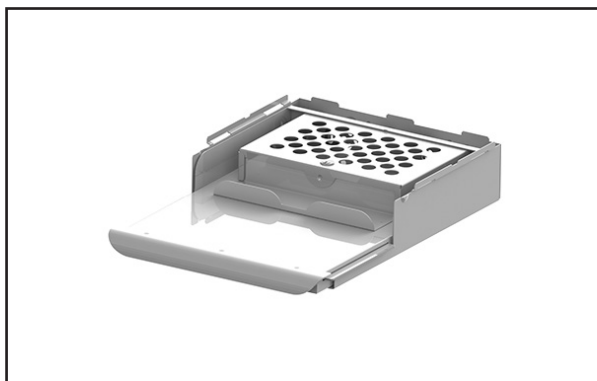

Keyport drawer unit

with mousepad 32116413

Metal design for safe accommodation of magnetic
keyboards. Lockable storage compartment

(e.g., for USB drives). Mousepad can be pulled

out left or right. Inside dimensions of the drawer

(W x D x H): 334 x 216 x 54 mm

Assembly in production of RIWomobil

RIWomobil

Accessories

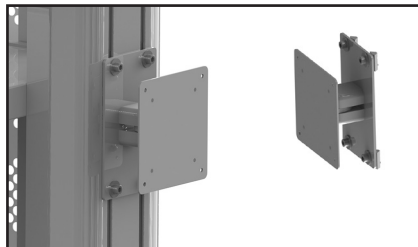

Monitor mount, lateral VESA 75/100 32116451

LCD monitor mount VESA 75/100 and adapter plate for side assembly on the RIWomobil (incl. fixing material).

Maximum load: 15 kg, Length: 5.5 cm,
can be mounted tiltable or swivelable

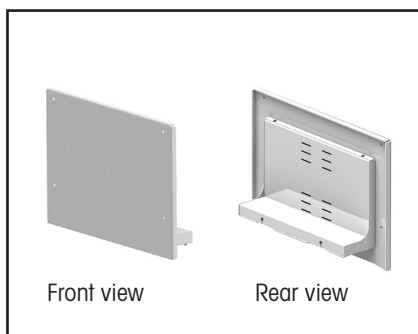

Monitor mount VESA 200 x 400 32116472

consisting of:

Monitor adapter plate VESA 200 x 400 and mounting bracket for fixing to RIWomobil 32116xxx.

Color: White RAL 9016

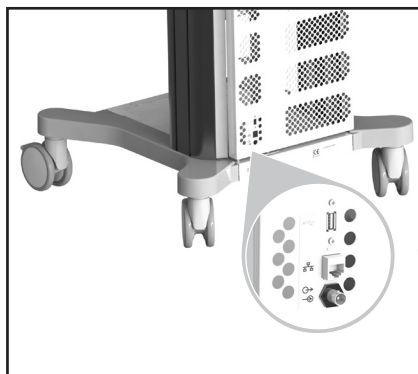

Feed-through adaptor USB, Ethernet, BNC 32116701

Cable adapter for USB (incl. 0.5 m extension),
RJ45 CAT.6A for Ethernet and BNC (for composite,
SDI, HD-SDI and 3G-SDI)

The feed-through adaptor is attached to the rear panel of RIWomobil.

Corresponding connections can remain hardwired inside the cart.

External cable connections are simply plugged in to the rear of RIWomobil.



IV Pole 32114.521

Bracket adjustable from 1.6 m to 2.6 m,

Load rating max. 8 kg

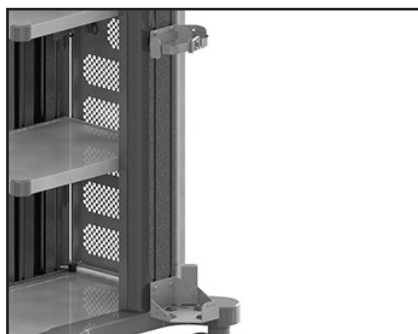

CO₂ bottle holder 10L 32114.535

Bracket for bottle \varnothing to max. 160 mm,

Load rating max. 35 kg

RIWomobil

Accessories



Remote control mounting 64030.106

for handheld remote control



Spiral hose 74021.031

for protecting and bundling several cables

when routing on swivel arms,

length 2.0 m



Transport lock 64267001

for securing Richard Wolf electrical medical

devices (width 300 mm) in RIWomobil 32116xxx

Roll Stand for LCD Monitors

Roll stands are ideal for flexible positioning of additional LCD monitors in an endoscopic operating room. An additional monitor gives the surgeon or camera assistant the option of optimized ergonomic working conditions. The ergonomic design of the UNI-CART roll stand is further improved if the LCD monitor can be optimally positioned with height adjustment.

Wireless transmission of HD signals by ZeroWire Ultra (page 38) reduces the need for complex cabling and further enhances flexibility.



UNI-CART with mechanical height adjustment **CD.00322.800**
 Mechanical height adjustment, 4 lockable twin swivel castors, Integrated 3-outlet power strip with medical grade power cord, VESA 100 monitor mount with power brick holder (load capacity: 14 kg / 30.8 lbs.)

Recommended Accessory:

Shelf with spare spring nuts W400 D360.....**TP.2026.903**

RIWomobil mini

Compact Office Video Cart Solution



The sleek and compact design of the RIWomobil mini offers safe transportation and storage for Richard Wolf endoscopy equipment.

- ❑ Integrated medical-grade power strip with four outlets and 15 ft. power cord
- ❑ Four lockable castors
- ❑ Adjustable IV pole (up to 96" from the ground)
- ❑ Storage drawer
- ❑ Adjustable endoscopy equipment shelf
- ❑ Designated printer shelf
- ❑ CO₂ tank holder (optional)
- ❑ Cart Dimensions: 23"W x 54"H x 26"D
- ❑ Cart Weight: 120 lbs.

RIWomobil mini **RWF3000**

CO₂ Tank Holder (optional) **RWF3800**