

Gynecology

1 *Hysteroscopy*

2 *Resection*

3 *Urogynecology*

4 *Laparoscopes*

5 *Trocars*

6 *ERAGONmodular*

7 *ERAGONbipolar*

8 *Laparoscopic Instruments*

9 *Accessories*

Richard Wolf Medical Instruments Corporation assumes no responsibility or liability for any errors or omissions in the content of this catalog. The information contained in this catalog is provided on an "as is" basis with no guarantees of completeness, accuracy, usefulness, or timeliness, and without warranties of any kind whatsoever, expressed or implied.

Basic Set for Hysteroscopy

Diagnostic

Telescope, 30°, 2.7 mm	8974.402
Fiber light cable, 2.5 mm bundle	806625301
Diagnostic hysteroscope sheath, 3.5 mm	8985.11
Luer lock adapter	886.00

Accessories:

Ergonomic handle	8986.251
Telescope protectors, pack of 5	8570.9325
Hysteroscopy tray, 2.7 mm	8570.027

Operative

Telescope, 30°, 2.7 mm	8974.402
Fiber light cable, 2.5 mm bundle	806625301
OptiFLOW continuous-flow operating sheath, 5.5 mm bundle	89743516

Accessories:

Stopcocks, 2.5 mm, (2 dots), pack of 5	896.0001
Rubber caps (red), (0.08 mm), pack of 10	88.01
Stopcocks, 3 mm, (3 dots), pack of 5	896.0002
Ergonomic handle	8986.251
Telescope protectors, pack of 5	8570.9325
Hysteroscopy tray, 2.7 mm	8570.027

Alternatively

Compact hysteroscope, 3.9 mm	8986402
Fiber light cable, 2.5 mm bundle	806625301
Rubber caps (red), (0.08 mm), pack of 10	88.01

Accessories:

Stopcocks, 3 mm, (3 dots), pack of 5	896.0002
Ergonomic handle	8986.251
Hysteroscopy tray, compact, laser etched	8570.040

Operative hand instruments

5 Fr. HySafe grasping forceps bundle	8642.6502
5 Fr. HySafe micro scissors bundle	8642.6812
5 Fr. HySafe biopsy forceps, spoon bundle	8642.6002
5 Fr. HySafe biopsy punch bundle	8642.6312

PANOVIEW PLUS Telescopes

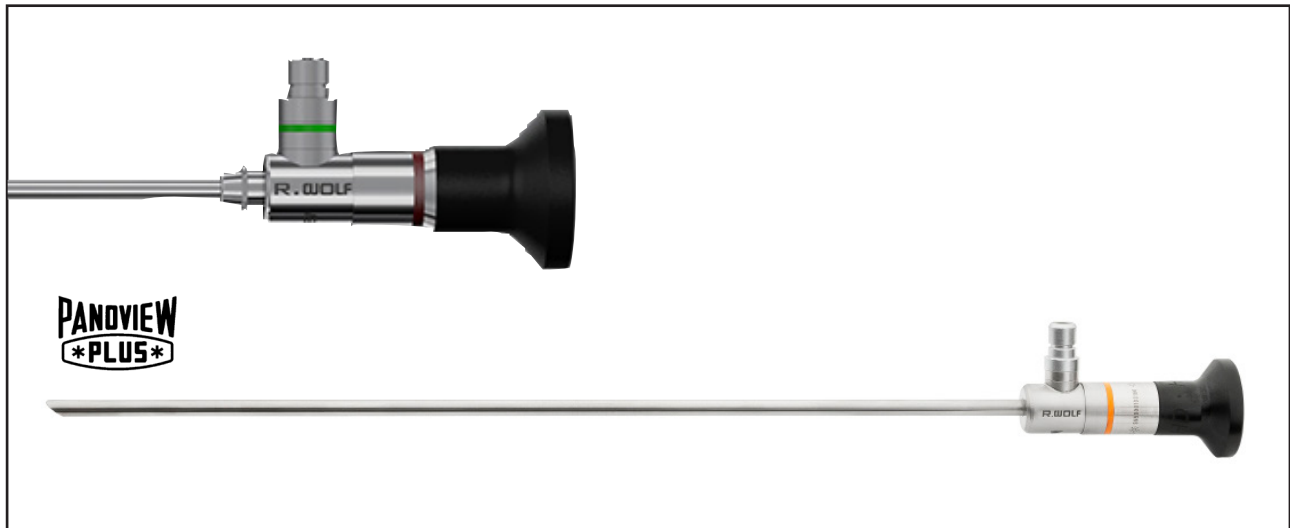

PANOVIEW PLUS telescopes with an enhanced field of view

- ❑ The enlargement of the field of view provides increased panorama

High-detail resolution

- ❑ 30% larger image size
 - Improved identification of fine tissue structures and vessels
- ❑ Improved resolution
- ❑ Focal depth combined with superior images provides excellent documentation
- ❑ Proprietary Richard Wolf lens geometry reduces the possibility of breakage within the optical system







All Richard Wolf endoscopes are steam sterilizable*

- ❑ Short sterilization times
- ❑ Economical with longer scope life
- ❑ Safe storage, shipment, and reprocessing with the special R. Wolf sterilization trays

* Please refer to specific endoscope IFU for detailed sterilization parameters.

PANOVIEW PLUS hysteroscopes

Overview

Angle of view	Color code	Outer diameter (Ø)	Working length (WL)	Product No.
0°	 blue	2 mm	270 mm	8754.401
		2.7 mm	310 mm	8462.30
		4 mm	305 mm	8650.414
12°	 orange	2.7 mm	300 mm	8974.412
		4 mm	305 mm	8654.431
30°	 red	3.9 mm	217 mm	8986402 compact
20°	 red	5 mm	217 mm	8986.401 compact
30°	 red	2.7 mm	300 mm	8974.402
		3.3 mm	305 mm	8656.422
		4 mm	300 mm	8989.412 wide angle view
		4 mm	305 mm	8654.422
70°	 yellow	4 mm	305 mm	8650.415

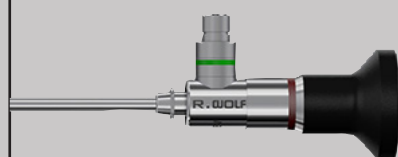

Flexible fiber-hysteroscope 2.5 mm / 7.5 Fr.

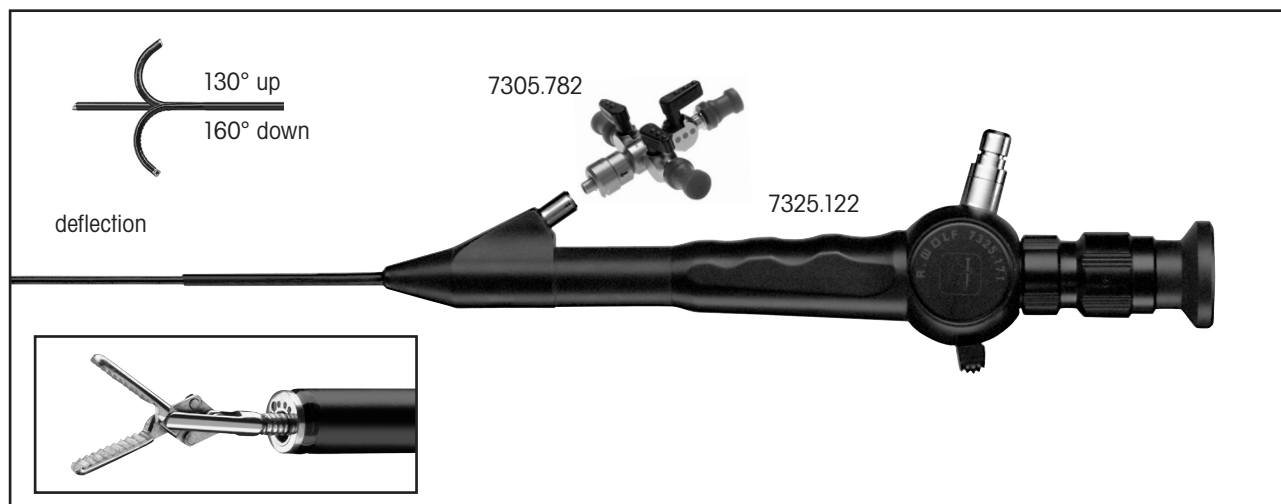

- ❑ Optimum ratio between sheath and instrument diameter - 2.5 / 1.2 mm with excellent image quality
- ❑ Easy to insert with stepless sheath over the entire working length
- ❑ Active deflection of 130° up / 160° down with extra passive deflection
- ❑ 0° position of the instrument tip can be clearly felt on the control lever
- ❑ Reduced weight and ergonomic design for optimal handling and less strain on the operator

	Outer diameter (Ø)	Working channel	Working length (WL)	Product No.
Fiber hysteroscope	2.5 mm / 7.5 Fr.	1.2 mm / 3.6 Fr.	200 mm	7325.122
Fiber hysteroscope bundle consisting of: Flexible fiber hysteroscope (7325.122), adapter with instrument port (7305.782), flexible biopsy forceps (7223.60), leak tester (163.903), pressure equalization valve (163.904), disposable cleaning brush (7990001)			200 mm	73251225
Fiber light cable bundle , Ø 1.6 mm consisting of: Fiber light cable (80661630), adapter projector-side (8095.07) and adapter endoscope-side (809509)			3 m	806616301
Flexible grasping forceps		1 mm / 3 Fr.	600 mm	7223.65
Flexible biopsy forceps		1 mm / 3 Fr.	600 mm	7223.60

Accessories:

Luer lock adapter	886.00
Rubber caps (red), (0.08 mm), pack of 10	88.01
Adapter with Instrument Port	7305.782
Biopsy Valve	7265.851
Instrument tray	85850302

Mini fiber hysteroscope 2 mm, 0°

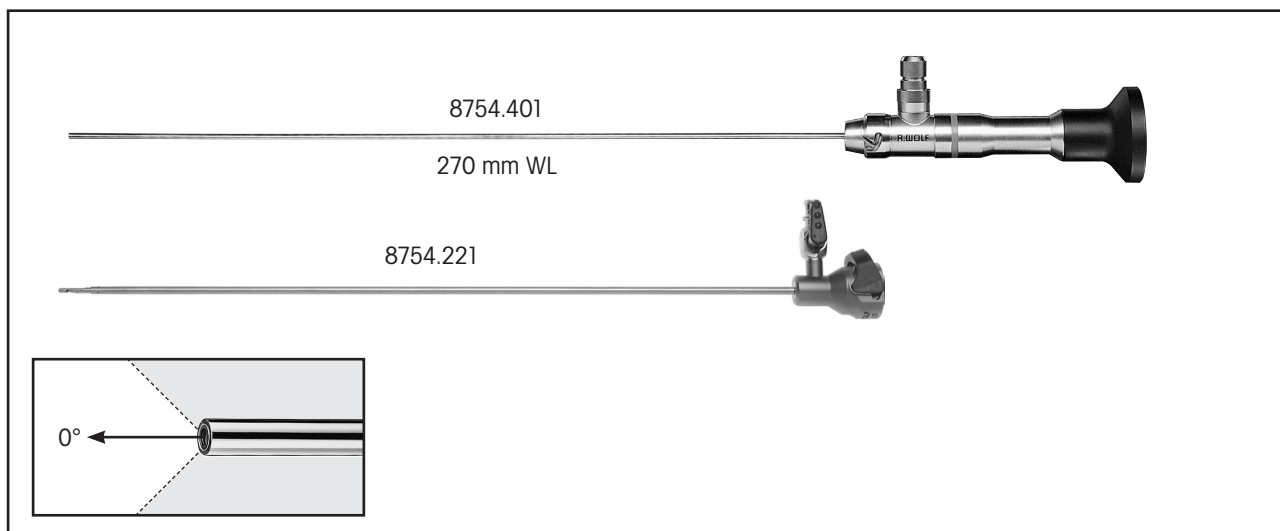

Mini fiber telescope

Ø 2 mm, 0° 8754.401

Outer sheath

Ø 2.8 mm, with insufflation tap, WL 250 mm 8754.221

Recommended light cable:

Fiber light cable bundle Ø 2.5 mm, 3 m long 806625301

consisting of:

Fiber light cable (80662530), adapter projector-side (8095.07) and adapter endoscope-side (809509)

Hysteroscopes 2.7 mm

HYSTEROSCOPY

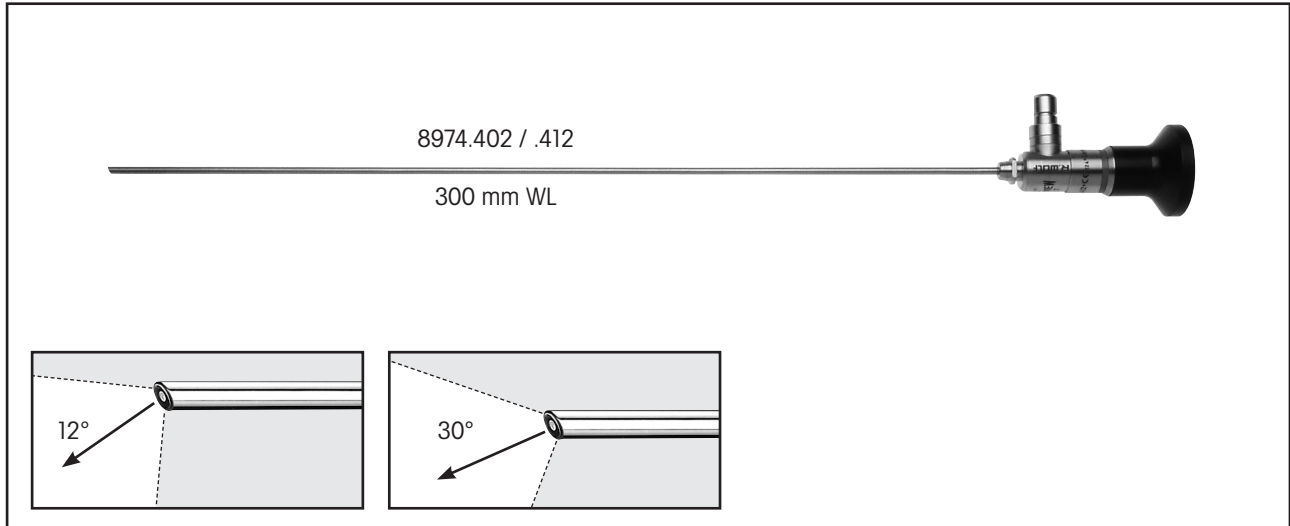

PANOVIEW PLUS telescope, Ø 2.7 mm,

12°	8974.412
30°	8974.402

Recommended light cable:

Fiber light cable bundle Ø 2.5 mm, 3 m long **806625301**

consisting of:

Fiber light cable (80662530), adapter projector-side (8095.07) and adapter endoscope-side (809509)

Accessories:

Single scope tray with brackets

(L x W x H) 16.1 x 3 x 1.3 in **8570.017**

Hysteroscope

4 mm, 30°

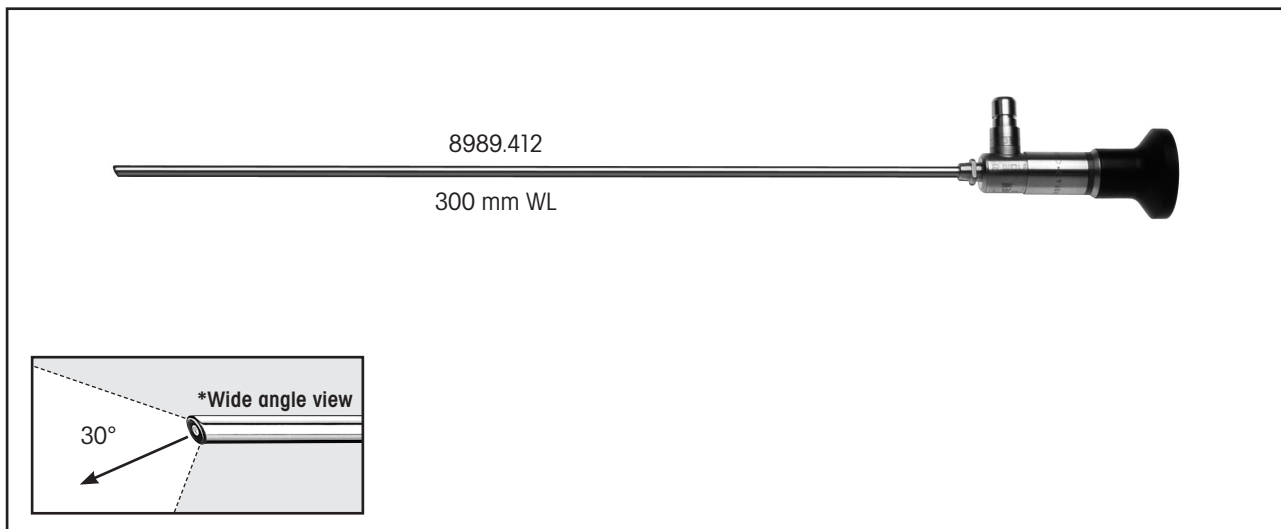

Field of view is 39% larger than standard endoscopes.

PANOVIEW PLUS telescope, Ø 4 mm,
30° **8989.412**

Recommended light cable:

Fiber light cable bundle Ø 3.5 mm, 3 m long **806635301**

consisting of:

Fiber light cable (80663530), adapter projector-side (8095.07) and adapter endoscope-side (809509)

Accessories:



Single scope tray with brackets

(L x W x H) 16.1 x 3 x 1.3 in **8570.017**

Diagnostic hysteroscope sheath
 Ø 3.5 mm / 10.5 Fr.
 for telescope 2.7 mm, 30°

HYSTEROSCOPY





		WL	Ø	Product No.
	Examination sheath	255 mm	3.5 mm / 10.5 Fr.	8985.11
	Ergonomic handle			8986.251

Diagnostic hysteroscope sheath

Ø 5 mm / 15 Fr.



for telescope 4 mm, 30°



		WL	Ø	Product No.
	Examination sheath with openings at the distal tip	255 mm	5 mm / 15 Fr.	8989.151
	Ergonomic handle			8986.251



Diagnostic continuous-irrigation hysteroscope sheath
 Ø 4 mm / 12 Fr., oval
 for telescope 2.7 mm, 30°

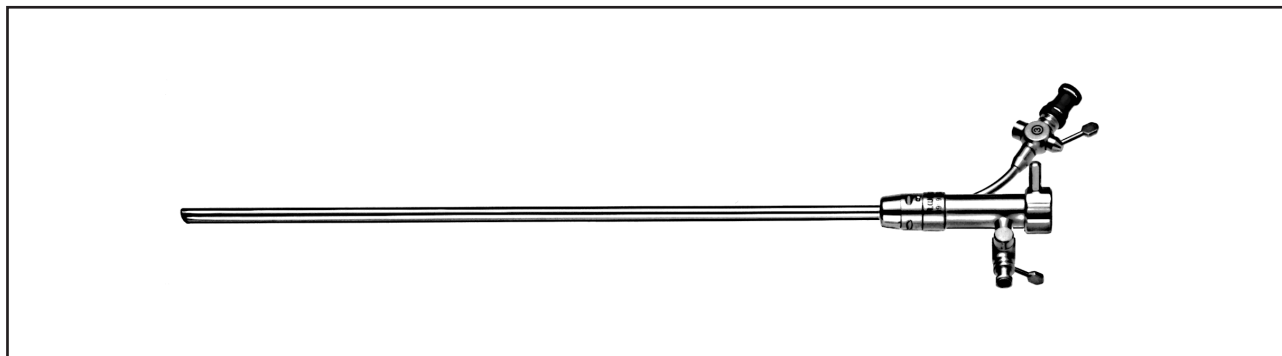

		Working channel	WL	Ø	Product No.
	Examination sheath	3 Fr.	245 mm	4 mm / 12 Fr.	8974.121
	Ergonomic handle				8986.251

Diagnostic continuous-irrigation hysteroscope sheath
 Ø 5 mm / 15 Fr., oval
 for telescope 4 mm, 30°



		Working channel	WL	Ø	Product No.
	Examination sheath with Luer tube connections (886.00) and rubber cap (88.005)	3 Fr.	230 mm	5 mm / 15 Fr.	8989.031
	Ergonomic handle				8986.251

Accessories:



Rubber caps (red), (0.8 mm), pack of 10 **88.01**

OptiFLOW continuous-flow operating sheath

Ø 5.5 mm / 16.5 Fr.

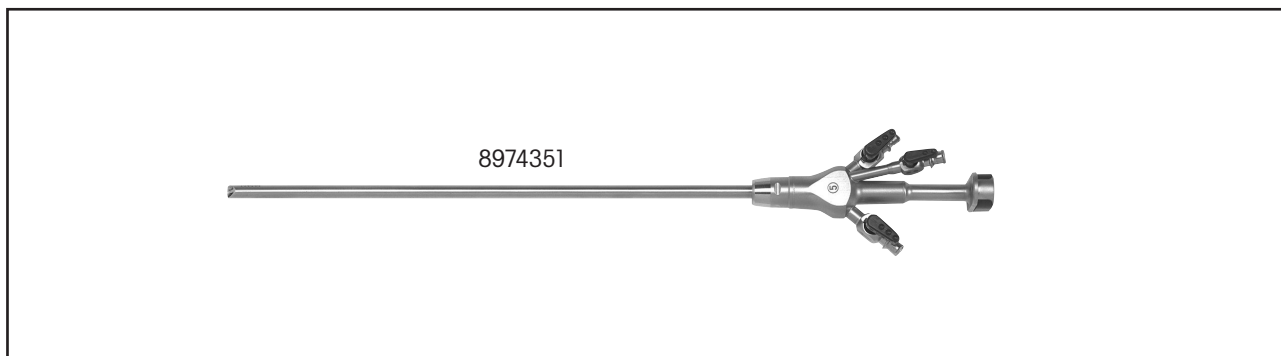
for telescope 2.7 mm, 12° and 30°



		Working channel	WL	Ø	Product No.	Bundle No.
	OptiFLOW continuous-flow operating sheath	5 Fr.	219 mm	5.5 mm / 16.5 Fr.	8974351	89743516
	Ergonomic handle				8986.251	

PANOVIEW PLUS telescope, Ø 2.7 mm,

12° **8974.412**

30° **8974.402**

OptiFLOW sheath bundle **89743516**

consisting of:

OptiFLOW sheath (8974351), rubber caps (red), 0.08 mm, pack of 10 (88.01), luer lock adapter (886.00),

cleaning brushes (7970705, 7990001, 7970402, 40999012)

Recommended light cable:

Fiber light cable bundle Ø 2.5 mm, 3 m long **806625301**

consisting of:

Fiber light cable (80662530), adapter projector-side (8095.07) and adapter endoscope-side (809509)

Accessories:

Luer lock adapter **886.00**

Rubber caps (red), (0.08 mm), pack of 10 **88.01**





Stopcocks, 2.5 mm, (2 dots), pack of 5 **896.0001**

Stopcocks, 3 mm, (3 dots), pack of 5 **896.0002**

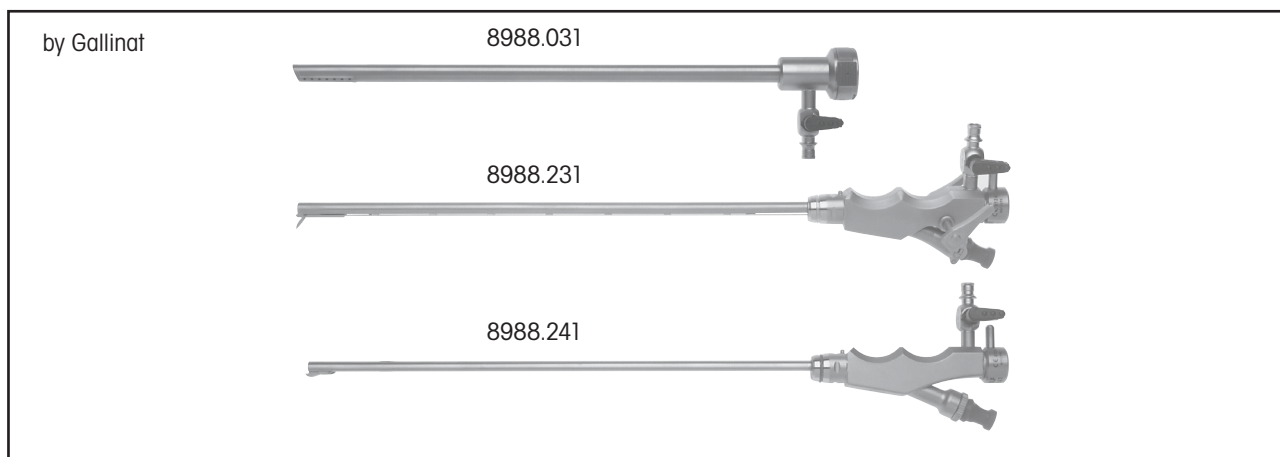
2.7 mm hysteroscopy tray **8570.027**



Continuous-irrigation operating
hysteroscope sheath Ø 7 mm / 21 Fr.
for telescope 4 mm, 30°

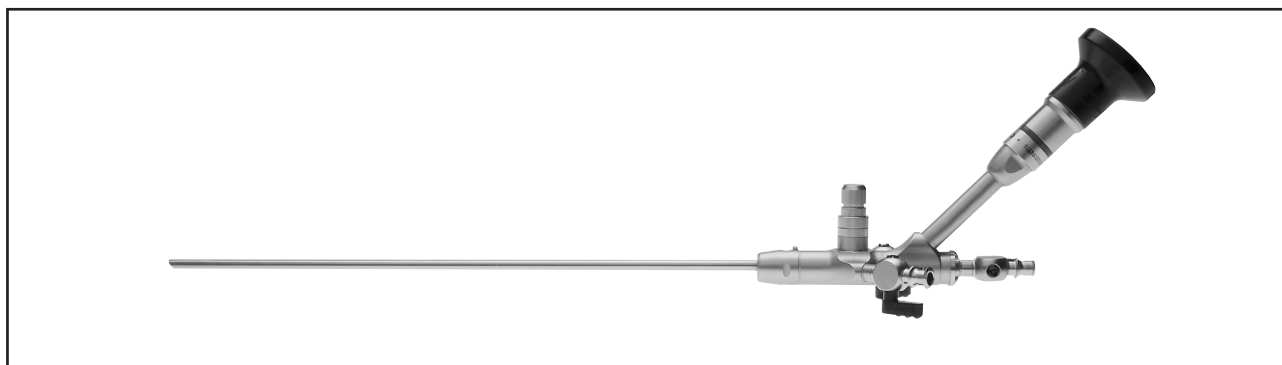

		Ø	Working Channel	WL	Product No.
	Operating sheath with oblique distal tip, swivel outlet tap and fast locking connector	7 mm / 21 Fr.		200 mm	8988.031
	Obturator specially for 8988.031			224 mm	8988.131
	Control insert with deflection lever, inlet tap and automatic valve for working channel, with sealing membrane (89.101)		7 Fr.		8988.231
	Working insert with ramp, inlet tap and automatic valve for working channel, with sealing membrane (89.101)		7 Fr.		8988.241

Compact hysteroscope 3.9 mm, 30°



		∅	Working channel	WL	Product No.
	Compact hysteroscope, 30°	3.9 mm	5 Fr.	217 mm	8986402
	Ergonomic handle				8986.251

- ❑ Compact and ergonomic system with atraumatic instrument tip
- ❑ Exceptional image quality in a smaller design
- ❑ Continuous irrigation via separate inflow and outflow channels for optimum viewing conditions
- ❑ Use of auxiliary instruments up to 5 Fr. via in-line working channel

Recommended light cable:

Fiber light cable bundle ∅ 2.5 mm, 3 m long **806625301**

consisting of:

Fiber light cable (80662530), adapter projector-side (8095.07) and adapter endoscope-side (809509)

Accessories:



Rubber caps (red), (0.08 mm), pack of 10 **88.01**

Stopcocks, 3 mm, (3 dots), pack of 5 **896.0002**

Compact hysteroscopy tray **8570.040**

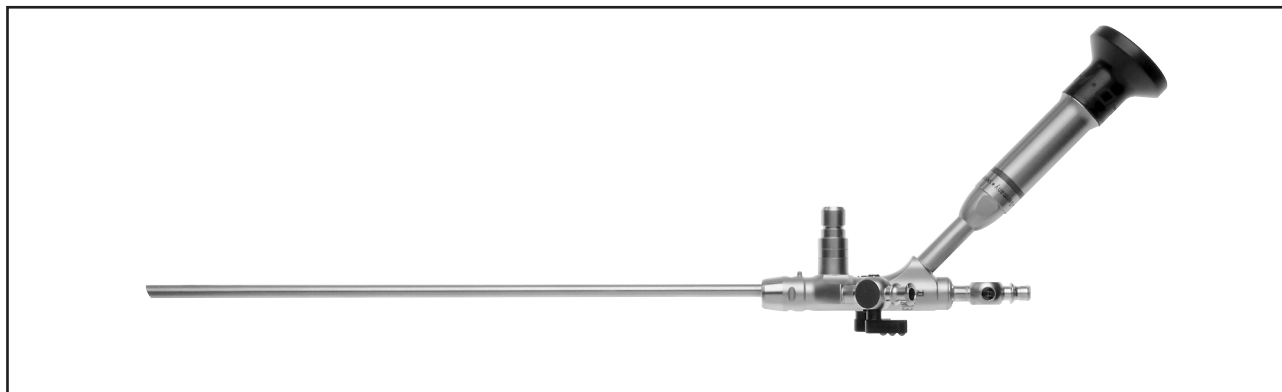
Compact hysteroscope 5 mm, 20°



		Ø	Working channel	WL	Product No.
	Compact hysteroscope, 20°	5 mm	5 Fr.	217 mm	8986.401
	Ergonomic handle				8986.251

- ❑ Compact and ergonomic system has small outer dimensions - large-lumen straight working channel
- ❑ Brilliant image and high light transmission with the PANOVIEW PLUS telescope and large field of view
- ❑ Round profile for easy introduction, usually without dilatation and better seal
- ❑ Continuous irrigation via separate inflow and outflow channels for optimum viewing conditions
- ❑ Use of auxiliary instruments up to 5 Fr. via in-line working channel

5 mm compact hysteroscope bundle **89864016**

consisting of:

Compact hysteroscope, 20° (8986.401), luer lock adapter (886.00), red rubber caps 10/pk, (88.01), cleaning brushes (7970402, 7970702, 40999012)

Recommended light cable:

Fiber light cable bundle Ø 2.5 mm, 3 m long **806625301**

consisting of:

Fiber light cable (80662530), adapter projector-side (8095.07) and adapter endoscope-side (809509)

Accessories:





Rubber caps (red), (0.08 mm), pack of 10 **88.01**

Stopcocks, 3 mm, (3 dots), pack of 5 **896.0002**

Compact hysteroscopy tray **8570.040**

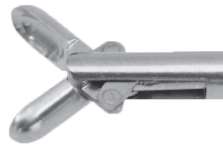
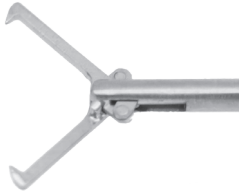
Single Piece Semi-Rigid Forceps/Scissors 5 Fr.



		WL	Ø	Product No.
	Alligator grasper, double action, single piece	340 mm	5 Fr.	86422436
	Cup biopsy forceps, double action, single piece	340 mm	5 Fr.	86422430
	Tenaculum, double action, single piece	340 mm	5 Fr.	86422341
	Hook scissors, single action, single piece	340 mm	5 Fr.	86422416
	Blunt scissors, single action, single piece	340 mm	5 Fr.	86422434
	Pointed scissors, single action, single piece	340 mm	5 Fr.	86422335

Rigid forceps 7 Fr.

HYSTEROSCOPY



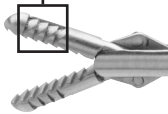



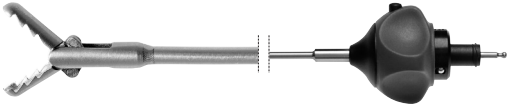

		WL	Ø	Product No.
	Dissecting forceps, grooved inner and outer surfaces of jaws and additional cutting edge	371 mm	7	8992.621

Forceps and scissors

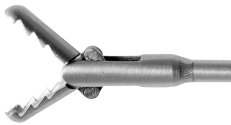
Micro modular system **HySafe**

HYSTEROSCOPY

Insert with sheath 	Recommended fields of application	Product No.	Ø	WL	Handle with overload protection 	Complete Instrument • Insert with sheath • Handle Bundle No.
Grasping forceps with alligator jaws 	Hysteroscopy	8642.6508	5 Fr.	340	8083.001	8642.6502
Biopsy forceps, spoon 		8992.6308	7 Fr.	310		8992.6302
Micro scissors 		8642.6008	5 Fr.	340		8642.6002
Biopsy punch 		8642.6818	5 Fr.	340		8642.6812
Hooked scissors 		8642.6318	5 Fr.	340		8642.6312
		8992.6408	7 Fr.	310		8992.6402

For cervix and uterus

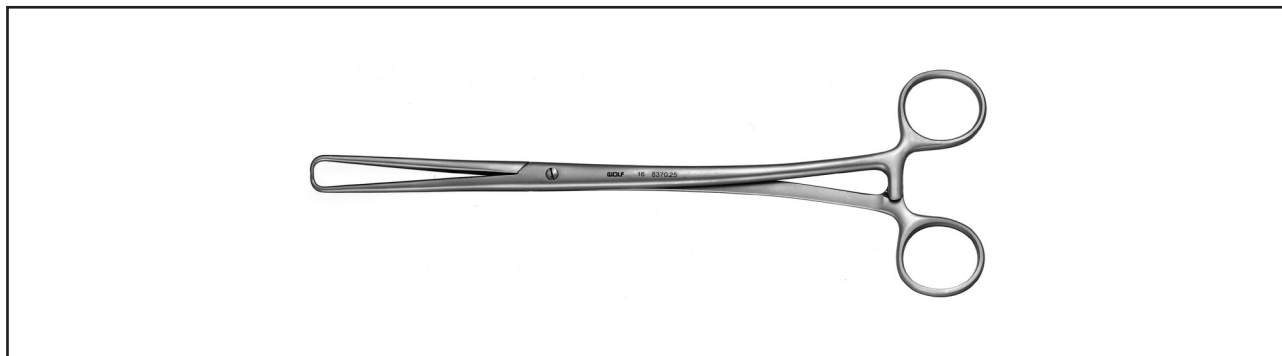

		WL	Product No.
	Tenaculum by Pozzi for grasping the cervix	92 mm	8370.25

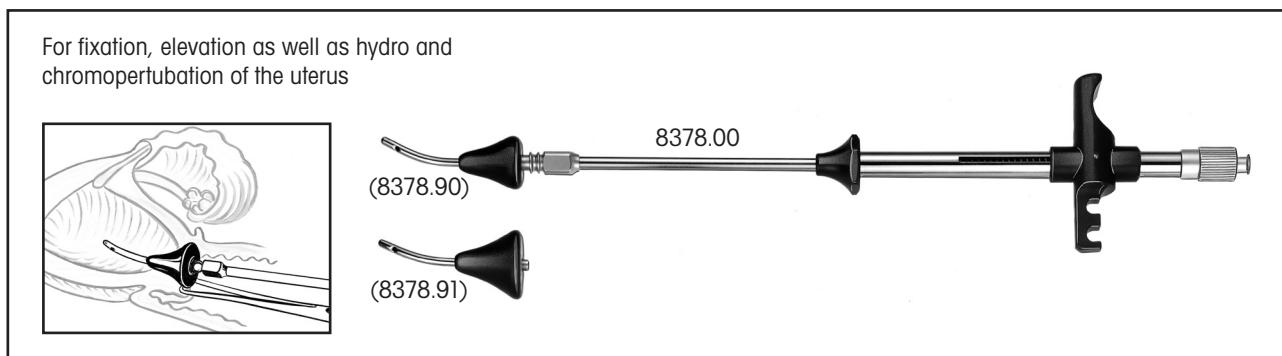

Intrauterine probe bundle **8378001**

consisting of:

Intrauterine probe by Cohen (8378.00) with spring-mounted forceps holder, 1 small (8378.90)
and 1 large (8378.91) cervical cone, luer lock tube fitting (886.00)

also:

Tenaculum by Pozzi **8370.25**

Office hysteroscopy

Disposable packs for in-office procedures

Office Hysteroscopy Disposable Packs



Standard office hysteroscopy pack 4974.0010

consisting of:

leggings; under buttocks drape; half drape; camera drape; table cover; alcohol swab; hand towels; prep kit with 2 large PVP sponge slickers, cysto tubing set; extension IV tubing set; sterile packed, disposable, 10 / box



Compact office hysteroscopy pack 4975.0010

consisting of:

under buttocks drape; half drape; camera drape; table cover; cysto tubing set; extension IV tubing set; sterile packed, disposable, 10 / box

Basic set for hysteroscopic resection

PRINCESS™ E-line & S(a)line System for

Telescope 2.7 mm, 12°, 21 Fr., passive, continuous irrigation

Fixed 21 Fr. Resectoscope

PANOVIEW PLUS telescope, 12°, 2.7 mm	8974.412
Continuous flow outer sheath	8653.021
Continuous flow inner sheath	8653.018
Working element, open, passive	8653.224
Obturator, for 21 Fr.	8653.18
Viewing obturator, for 21 Fr.	865319
Fiber light cable, 2.5 mm bundle	806625301

Rotatable 21 Fr. Resectoscope

PANOVIEW PLUS telescope, 12°, 2.7 mm	8974.412
Continuous flow outer sheath, rotatable	8653022
Continuous flow inner sheath, rotatable	86530191
Rotatable connector.....	86533643
Working element, open, passive	8653.224
Obturator, for 21 Fr.	8653.18
Viewing obturator, for 21 Fr.	865319
Fiber light cable, 2.5 mm bundle	806625301

Rotatable 24 Fr. Resectoscope

PANOVIEW PLUS telescope, 12°, 2.7 mm	8974.412
Continuous flow outer sheath, rotatable	8655.334
Continuous flow inner sheath, rotatable	8655.3441
Rotatable connector.....	8654.3642
Working element, open, passive	8653.224
Obturator, for 24 Fr.	8654.16
Viewing obturator, for 24 Fr.	865319
Fiber light cable, 2.5 mm bundle	806625301

Accessories:

Working insert, up to 7 Fr.	8653284
Telescope protectors, pack of 5	8570.9325
Universal tray, 3 brackets	8585.023
Rubber caps (red), (0.08 mm), pack of 10	88.01
Luer lock adapter	886.00

Replacement Parts:

Replacement (blue) quad lip seal	15176.127
--	-----------

Electrodes

21 Fr. cutting "loop" electrode	4653.1313
24 Fr. cutting "loop" electrode	4653.1323
21 Fr. & 24 Fr. roller electrode	4653.023
21 Fr. & 24 Fr. hook electrode	4653033
21 Fr. BiVAP electrode	46530213
24 Fr. BiVAP electrode	46530243



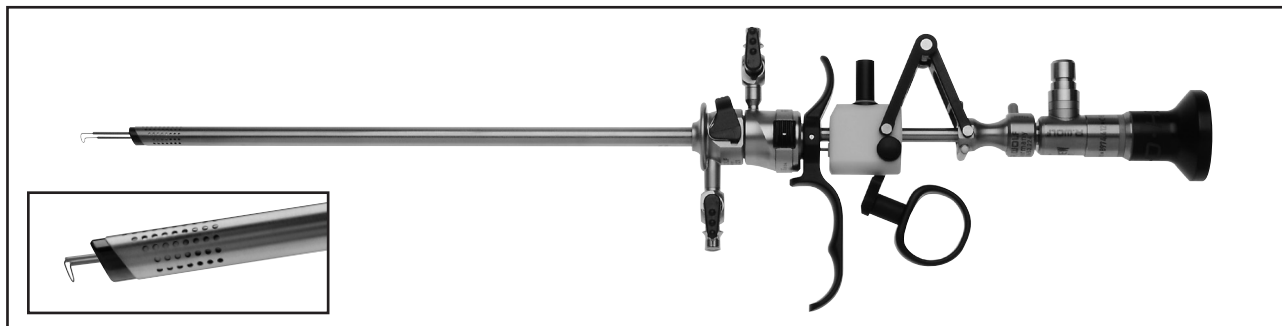

PRINCESS™

Petite resectoscope including E-line & S(a)line System

Fixed 21 Fr. Resectoscope

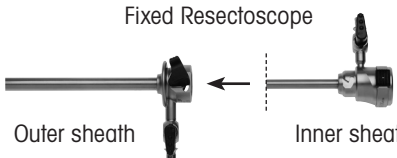

RESECTION

Size / Color code	Distal tip	Sheaths, inner sheath with distal ceramic insulation	Obturator	Viewing obturator
		<p>Fixed Resectoscope</p>  <p>Outer sheath Inner sheath</p>		
7 mm / 21 Fr. black		8653.021 8653.018	8653.18	865319

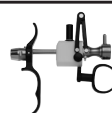
Working element	Handle type	Cutting action	Product No.
 Spring-assisted cutting action	open	passive	8653.224

Working insert	Working channel	Product No.
	up to 7 Fr.	8653284

Ø	Angle of view	Product No.	PANOVIEW PLUS telescope
2.7 mm	12°	8974.412	

Accessories:

Fiber light cable bundle, Ø 2.5 mm, 3 m long **806625301**

Consisting of:

Fiber light cable (80662530), adapter projector side (8095.07) and adapter endoscope side (809509)

Universal tray, with 3 brackets **8585.023**

Monopolar connecting cable 815.033, 815.132, 815.053; Bipolar connecting cable 21196-119





PRINCESS™

Petite resectoscope including E-line & S(a)line System

Rotatable 21 Fr. & 24 Fr. Resectoscopes

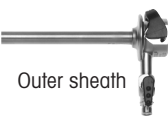
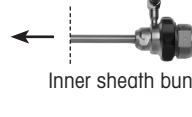

RESECTION

Size / Color code	Distal tip	Sheaths, inner sheath with distal ceramic insulation		Inner sheath bundle		Obturator	Viewing obturator
Sheaths		Rotatable Resectoscope		consisting of:			
		 Outer sheath	 Inner sheath bundle	Inner sheath	Rotatable connector		
7 mm / 21 Fr. black		8653022	8653019 (19 Fr.)	86530191	86533643	8653.18	865319
8 mm / 24.5 Fr. green		8655.334	8655.344 (22.5 Fr.)	8655.3441	8654.3642	8654.16	-

Working element	Handle type	Cutting action	Product No.
 Spring-assisted cutting action	open	passive	8653.224

Working insert	Working channel	Product No.
	up to 7 Fr.	8653284

Ø	Angle of view	Product No.	PANOVIEW PLUS telescope
2.7 mm	12°	8974.412	

Accessories:

Fiber light cable bundle, Ø 2.5 mm, 3 m long **806625301**

Consisting of:

Fiber light cable (80662530), adapter projector side (8095.07) and adapter endoscope side (809509)





Universal tray, with 3 brackets **8585.023**

Monopolar connecting cable 815.033, 815.132, 815.053; Bipolar connecting cable 21196-119

PRINCESS™

Disposable electrodes

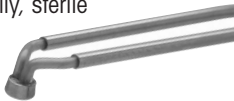
for resectoscopes with telescope 2.7 mm, 12°

	Loop		7 mm / 21 Fr.	8 mm / 24.5 Fr.
Cutting electrode, bipolar/monopolar, 3/box, packed individually, sterile 	0.3 mm	Branches	transparent	transparent
			4653.1313	4653.1323
		Stem	blue	blue
Roller electrode, bipolar/monopolar, 3/box, packed individually, sterile 		Branches	transparent	
			4653.023	
		Stem	blue	
BIVAP electrode, bipolar, 3/box, packed individually, sterile 	0.3 mm	Branches	blue	blue
			46530213	46530243
		Stem	blue	blue
Hook electrode, bipolar/monopolar, 3/box, packed individually, sterile 		Branches	transparent	
			4653033	
		Stem	blue	

RESECTION

Shark Resectoscope, bipolar
for telescope 4 mm, 12° / 30°

with continuous irrigation double-sheath system for resection in saline

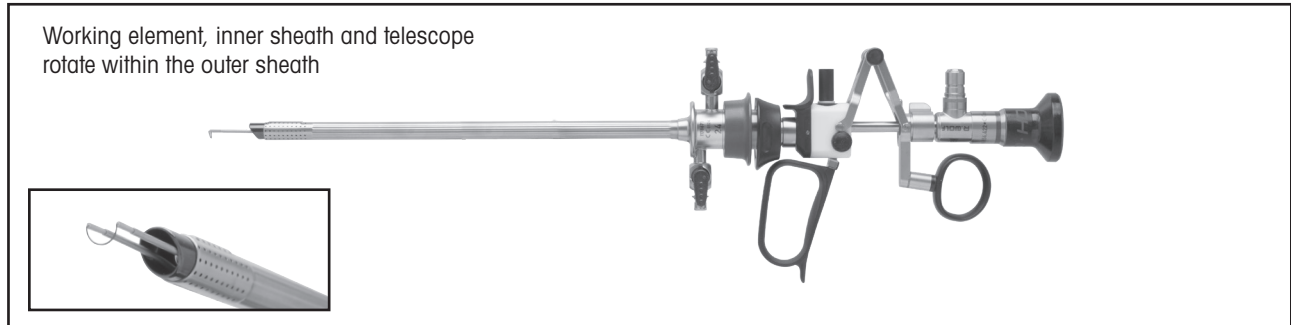

Size / Color code	Distal tip	Sheaths, inner sheath with distal ceramic insulation	Obturator	Viewing obturator
Sheaths		<p>Rotatable Resectoscope</p> <p>Outer sheath Inner sheath</p>		
22 / 24 Fr. green		8675424 8675322	8673022	8673122

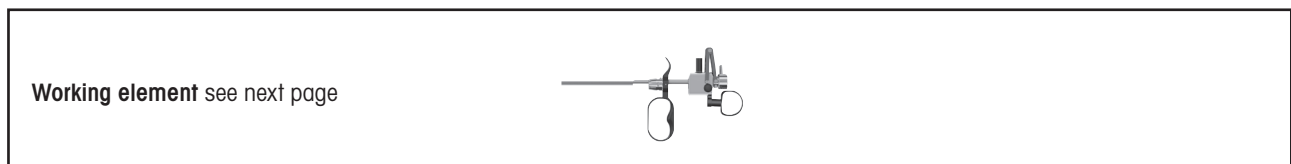

Ø	Angle of view	Product No.	PANOVIEW PLUS telescopes*
4 mm	30°	8654.422	
	12°	8654.431	

*with enlarged image and objective field

Recommended light cable:

Fiber light cable bundle, Ø 2.5 mm, 3 m long **806625301**

Consisting of:

Fiber light cable (80662530), adapter projector side (8095.07) and adapter endoscope side (809509)

Working elements for
Shark resectoscope, bipolar

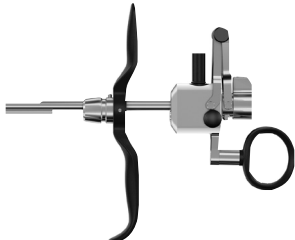
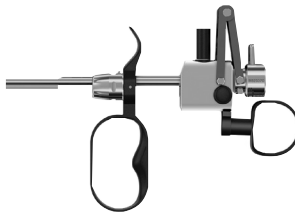

Telescope 4 mm, 12° / 30°

Working element	Handle type	Cutting action	Product No.
	open	passive	8680.224
 <p data-bbox="188 757 475 786">Spring-assisted cutting action</p>	closed	passive	8680.225

RESECTION

Disposable electrodes for resectoscope, bipolar





Telescope 4 mm, 12° / 30°

	Loop		22 / 24 Fr.
Cutting electrode, round, bipolar, 3/box, packed individually, sterile 	0.25 mm	Branches	blue
			4622.2533
	0.3 mm	Stem	blue
		Branches	blue
			4622.1333
		Stem	blue
Coagulating electrode, bipolar, 3/box, packed individually, sterile 	-	Branches	blue
			4623.0243
		Stem	blue
BIVAP electrode, bipolar, 3/box, packed individually, sterile 	-	Branches	blue
			46300223
		Stem	blue

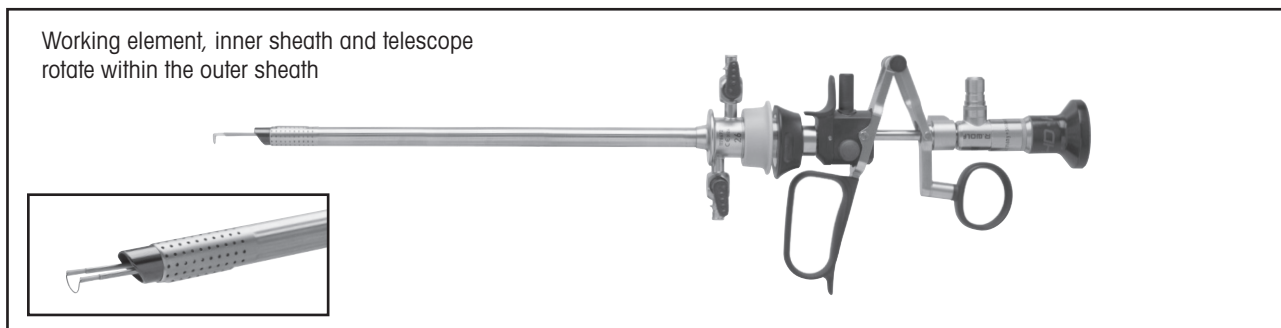
RESECTION

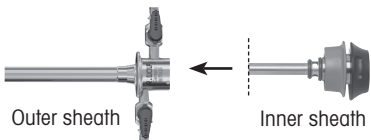
Shark Resectoscope, monopolar
for telescope 4 mm, 12° / 30°
with continuous irrigation double-sheath system



Size / Color code	Distal tip	Sheaths, inner sheath with distal ceramic insulation	Obturator	Viewing obturator
Sheaths		 <p>Outer sheath Inner sheath</p>		
22 / 24 Fr. green		8675424 8675322	8673022	8673122

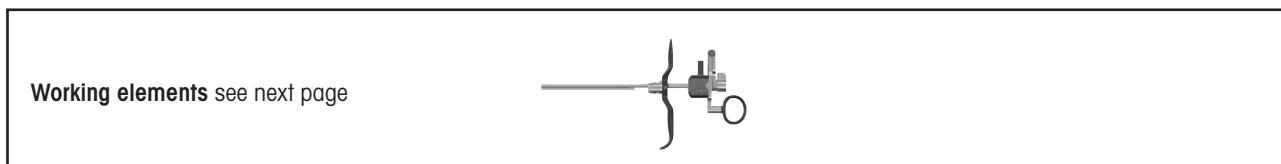

Ø	Angle of view	Product No.	PANOVIEW PLUS telescopes*
4 mm	30°	8654.422	
	12°	8654.431	

*with enlarged image and objective field

Recommended light cable:

Fiber light cable bundle, Ø 2.5 mm, 3 m long **806625301**

Consisting of:

Fiber light cable (80662530), adapter projector side (8095.07) and adapter endoscope side (809509)

Monopolar cable 815.132, 815.033, 815.053.

Working elements for **Shark** resectoscope, monopolar

Telescope 4 mm, 12° / 30°

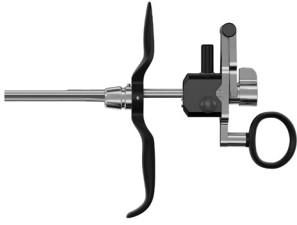
Working element	Handle type	Cutting action	Product No.
	closed	passive	8674225
 <p>Spring-assisted cutting action</p>	open	passive	8674224







RESECTION

Accessories:

Rubber caps (red), pack of 5 **8874**
(for sealing the electrode clamping on the working element)







Disposable electrodes for resectoscope, monopolar

Telescope 4 mm, 12° / 30°

	Loop		22 / 24 Fr.
Cutting electrode, 10/box, packed individually, sterile 	0.35 mm	Branches	green
			46782235
		Stem	transparent
	0.25 mm	Branches	green
			46782225
		Stem	transparent
Coagulating electrode, 5/box, packed individually, sterile 	Roller	Branches	green
			46782201
		Stem	transparent
Coagulating electrode, 5/box, packed individually, sterile 	Sphere	Branches	green
			46782202
		Stem	transparent
Coagulating electrode, 5/box, packed individually, sterile 	Button	Branches	green
			46782203
		Stem	transparent
Knife electrode, 5/box, packed individually, sterile 	Knife	Branches	green
			46782204
		Stem	transparent
Hook electrode, 5/box, packed individually, sterile 	Hook	Branches	green
			46782205
		Stem	transparent

RESECTION









HF Monopolar Connecting Cables

Connector for instrument	Connector for unit	Length	Product No.
WOLF resectoscopes 	 ERBE (T series)	3 m	815.132
	 Bovie / Volleylab / ERBE (Int.) / BOWA (Int.)	3 m	815.033
		5 m	815.053
	WOLF instruments 	 ERBE (T series)	3 m
 Bovie / Volleylab / ERBE (Int.) / BOWA (Int.)		3 m	8106.033
		5 m	8106.053

RESECTION

HF Bipolar Connecting Cables

RESECTION



Connector for instrument	Connector for unit	Length	Product No.
<p>WOLF S(a)line resectoscopes</p> 	 <p>ERBE VIO 3</p>	4.5 m	21196-119
<p>Bipolar tweezers</p> 		3 m	8108.133
		3 m	8108.131
		3 m	8108135

Cysto-urethroscope

8650 *E-line*

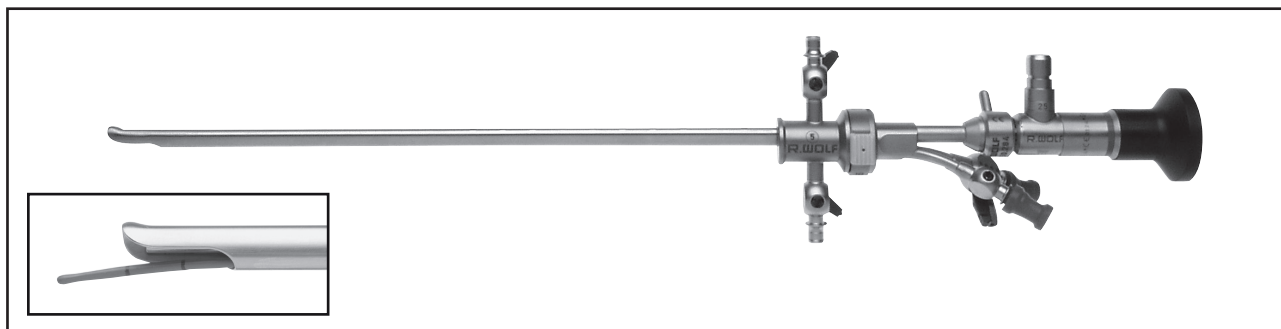
for telescope 4 mm, 0°, 12°, 30°, 70° and adapters



Sheaths and obturators						Adapters		
								
						No working channel	1 working channel	2 working channels
Sheath incl. obturator	Sheath	Obturator	Size (Fr.)	Color code	Capacity (Fr.)	8650.254	8650.264	8650.284
8650.0141	8650.0145	8650.0147	16	yellow	1x5*			
8650.0241	8650.0245	8650.0247	17.5	green	1x5 or 2x4			
8650.0341	8650.0345	8650.0347	19.5	red	1x7 or 2x5			
8650.0441	8650.0445	8650.0447	21	blue	1x10 or 2x6			
8650.0541	8650.0545	8650.0547	23	white	1x12 or 2x7			
8650.0641	8650.0645	8650.0647	25	black	1x15			

* for urethroscopy (cystoscopy for diagnosis only with adapter 8650.254)

∅	Angle of view	Product No.	PANOVIEW telescopes*
4 mm	0°	8650.414	
	12°	8654.431	
	30°	8654.422	
	70°	8650.415	

*with enlarged image and objective field



UROGYNECOLOGY

Cysto-urethroscope

8650 *E-line*

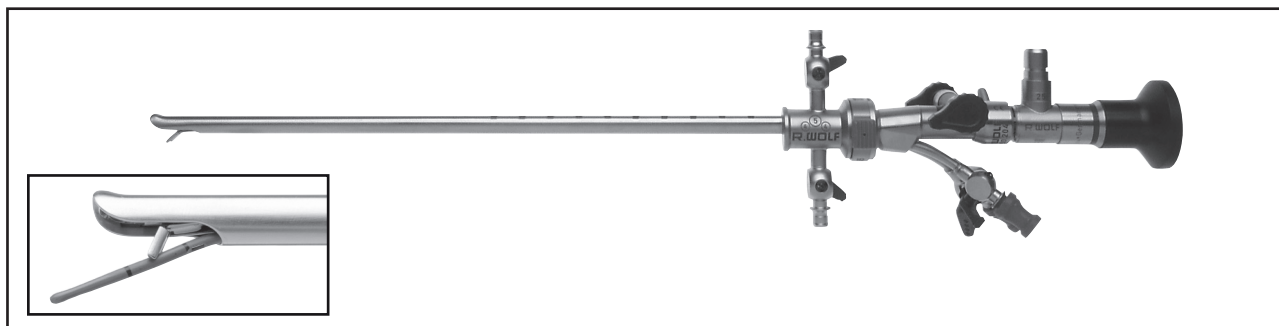
for telescope 4 mm, 30°, 70° and inserts with Albarran deflector



Sheaths and obturators						Inserts with Albarran deflector	
							
							
Sheath incl. obturator	Sheath	Obturator	Size (Fr.)	Color code	Capacity (Fr.)	1 working channel	2 working channels
8650.0241	8650.0245	8650.0247	17.5	green	1x5 or 2x4	8650.214	8650.204
8650.0341	8650.0345	8650.0347	19.5	red	1x7 or 2x5		
8650.0441	8650.0445	8650.0447	21	blue	1x10 or 2x6		
8650.0541	8650.0545	8650.0547	23	white	1x12 or 2x7		

∅	Angle of view	Product No.	PANOVIEW telescopes*
4 mm	30°	8654.422	
	70°	8650.415	

*with enlarged image and objective field

UROGYNECOLOGY

Atraumatic Compact Cysto-Urethroscopes





14 Fr., 25°



- ❑ Outpatient urethro-cystoscopy, with less stress on the patient
- ❑ Foreign body extraction (e.g. removal of stents)
- ❑ Retrograde manipulation
- ❑ Treatment of strictures
- ❑ Powerful PANOVIEW PLUS telescope, 25° viewing direction, panoramic field of view, exceptional detail
- ❑ Specially shaped, atraumatic distal tip
- ❑ Compact and sturdy construction

Compact cysto-urethroscope, atraumatic	WL (mm)	Size (Fr.)	Working channel	Shape	25° Telescope
8642.403	215	14	5 Fr.	oval	PANOVIEW Plus with enlarged image and object field



Flexible accessory instruments
atraumatic compact cysto-urethrosopes
14 Fr., 25°

		WL (mm)	Size	Product No.
	Flexible biopsy forceps	315	5 Fr.	829.05
		375	7 Fr.	829.07
	Flexible foreign body forceps	315	5 Fr.	828.05
		365	7 Fr.	828.07
	Flexible scissors with indented edge	375	7 Fr.	830.07
	Flexible coagulating button electrode, monopolar	400	6 Fr.	823.06
		400	5 Fr.	823.05

UROGYNECOLOGY

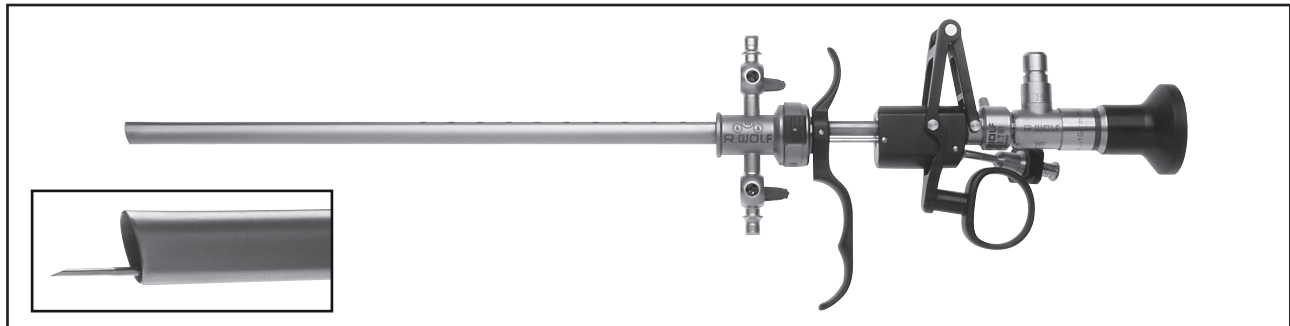
Set for transurethral incontinence therapy *E-line*

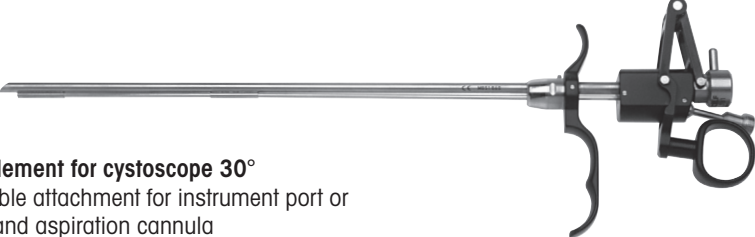

	Product No.
 <p>Working element for cystoscope 30° with rotatable attachment for instrument port or injection- and aspiration cannula</p>	8652.781
 <p>Guiding instrument for accessory instruments up to 4 Fr.</p>	8652.788
 <p>Sheath with obturator 21 Fr. for instruments up to 10 Fr. or 2x6 Fr.</p>	8652.0441

Telescope	Ø	Angle of view	Product No.	PANOVIEW Plus telescope*
	4 mm	30°	8654.422	

*with enlarged image and objective field

Mini Fiber Telescopes 2 mm

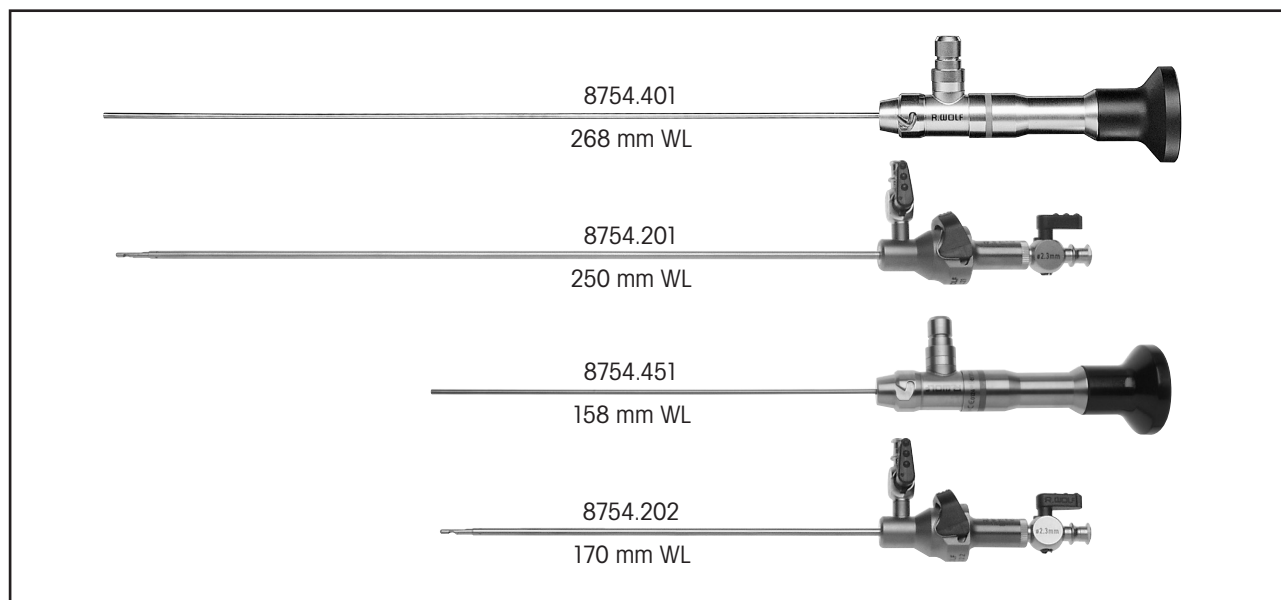

WL 268 mm standard version

Mini fiber telescope,

Ø 2 mm, 0° **8754.401**

Veres needle, Ø 2.3 mm (8754.211), with Ø 2.8 mm outer sheath (8754.221) 8754.201

WL 158 mm standard version

Mini fiber telescope,

Ø 2 mm, 0° **8754.451**

Veres needle, Ø 2.3 mm (8754.212), with Ø 2.8 mm outer sheath (8754.222) 8754.202

Recommended light cable:

Fiber light cable bundle, Ø 2.5 mm, 3 m long 806625301

consisting of:

Fiber light cable (80662530), adapter projector side (8095.07) and adapter endoscope side (809509)

Accessories:

Scope protector (for telescope 8754.401 and 8754.451)

WL 320 mm, pack of 5..... **85709325**

Single scope tray (for telescope 8930.461 and 8930.462)..... **8570.017**

Laparoscopes 3.5 mm

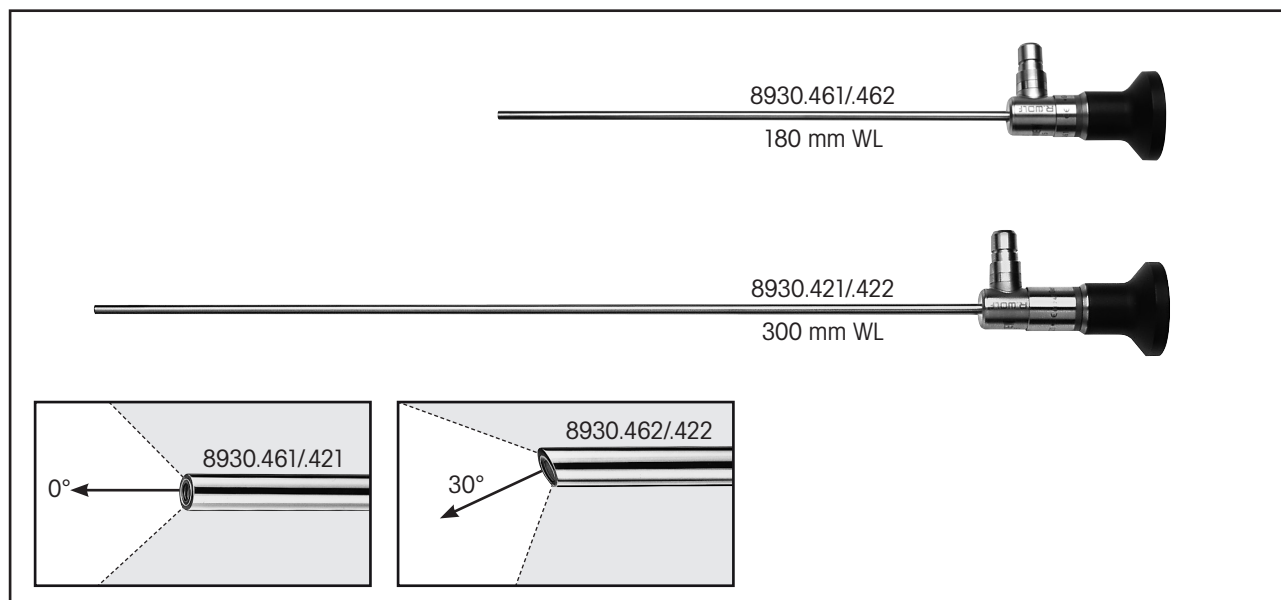

WL 180 mm

PANOVIEW PLUS telescope, Ø 3.5 mm,

0°	8930.461
30°	8930.462

WL 300 mm

PANOVIEW PLUS telescope, Ø 3.5 mm,

0°	8930.421
30°	8930.422

Recommended light cable:

Fiber light cable bundle, Ø 2.5 mm, 3 m long **806625301**

consisting of:

Fiber light cable (80662530), adapter projector side (8095.07) and adapter endoscope side (809509)

Accessories:

Scope protector (for telescope 8930.461 and 8930.462)

WL 200 mm, pack of 5 **8570.9205**

Scope protector (for telescope 8930.421 and 8930.422)

WL 320 mm, pack of 5..... **8570.9325**

Single scope tray (for telescope 8930.461 and 8930.462)..... **8570.017**

Laparoscopes 5.3 mm distortion-free

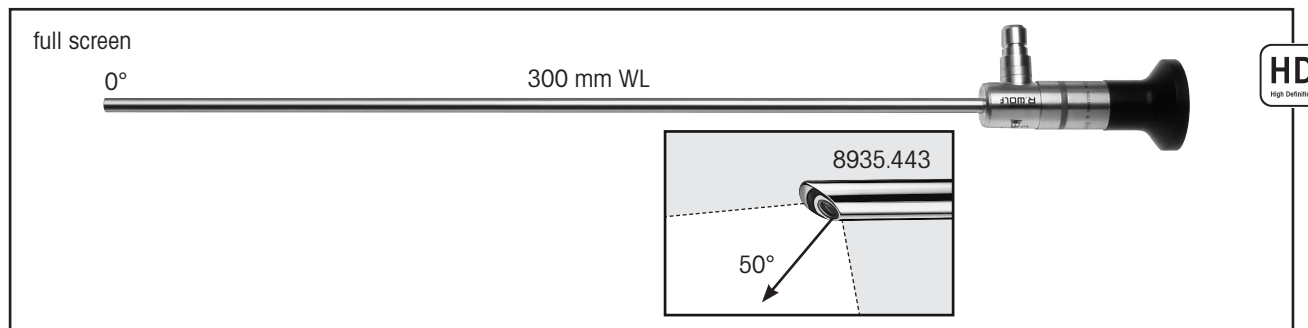

PANOVIEW telescope, Ø 5.3 mm, distortion-free, full screen

50° **8935.443**

Recommended light cable:

Fiber light cable bundle, Ø 3.5 mm, 3 m long **806635301**

consisting of:

Fiber light cable (80663530), adapter projector side (8095.07) and adapter endoscope side (809509)

Accessories:

Scope protector (for telescope 8935.443)

WL 320 mm, pack of 5..... **8570.9325**

Single scope tray (for telescope 8935.443)..... **8570.017**

Mini-Operating-Laparoscope 5.5 mm with 3.5 mm Working Channel

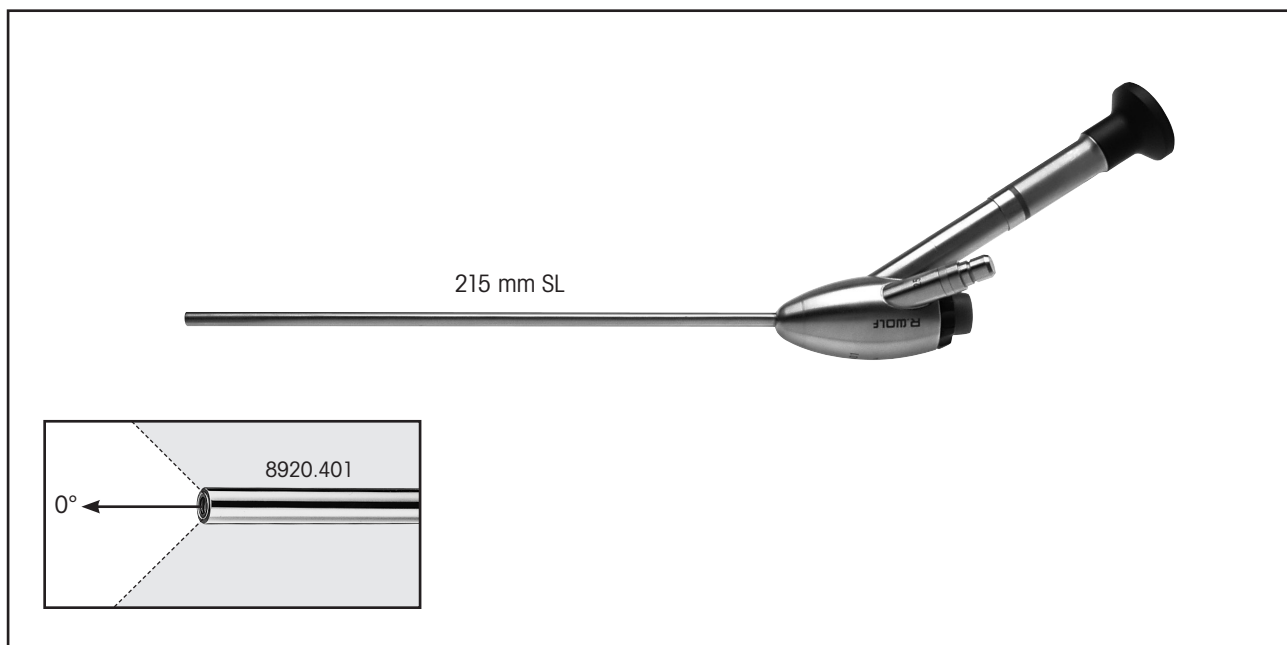

OP Endoscope bundle, Ø 5.5 mm, SL 215 mm89204015

consisting of:

OP endoscope with 3.5 mm working channel (8920.401), sealing element (8920.311), sealing cap (89.01), sealing membrane (89.103)

Spare membrane valves, yellow, pack of 1089.103

Recommended light cable:

Fiber light cable bundle Ø 2.5 mm, 3 m long806625301

consisting of:

Fiber light cable (80662530), adapter projector side (8095.07) and adapter endoscope side (809509)

The trocar sleeves 8919.333 / .353 with optimized working length are recommended.

Telescopes 5.5 mm optimized for 4K UHD

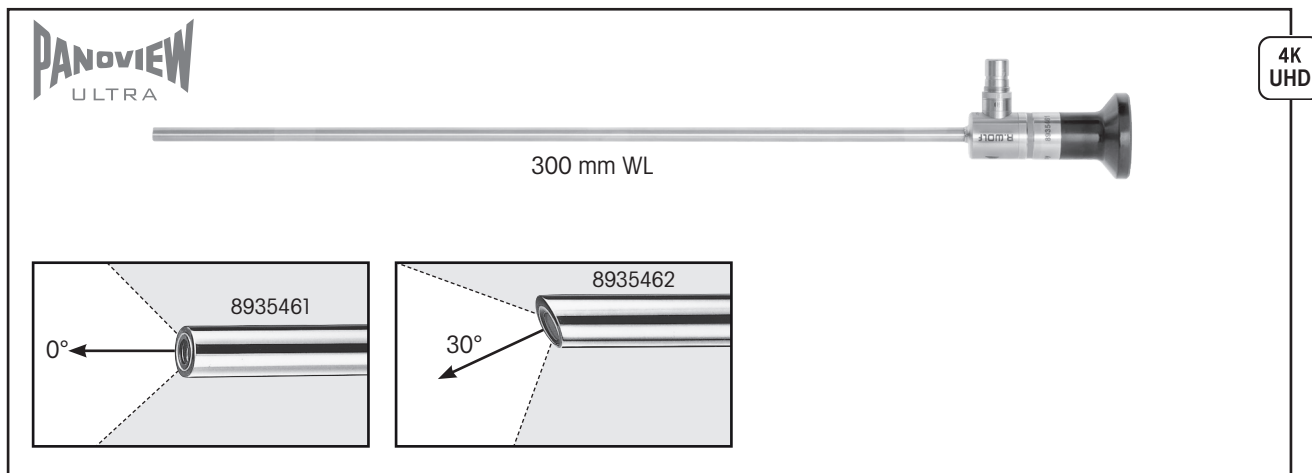

PANOVIEW ULTRA telescope, Ø 5.5 mm,

distortion-free, full screen

0° **8935461**

30° **8935462**

Recommended light cable:

Fusion fiber light cable bundle, Ø 5.0 mm, 3 m long **806550301**

consisting of:

Fiber light cable (80655030), adapter projector side (8095.07) and adapter endoscope side (809509)

Accessories:

Single scope tray **8570.017**

Telescopes 5.5 mm
optimized for 4K UHD
bariatric length

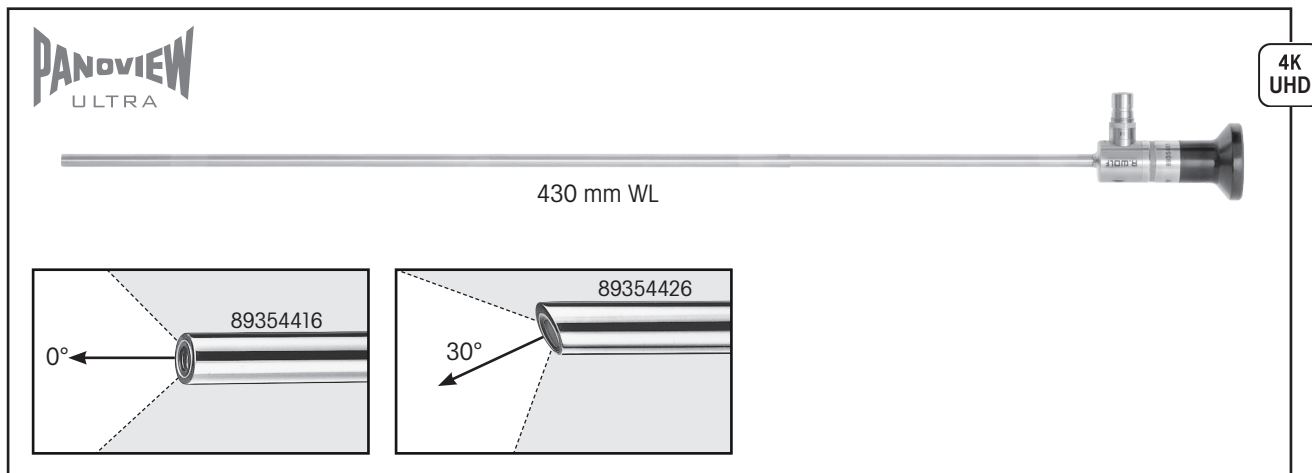

PANOVIEW ULTRA telescope, Ø 5.5 mm,

distortion-free, full screen

0° **89354416**

30° **89354426**

Recommended light cable:

Fusion fiber light cable bundle, Ø 5.0 mm, 3 m long **806550301**

consisting of:

Fiber light cable (80655030), adapter projector side (8095.07) and adapter endoscope side (809509)

Accessories:

Single scope tray **8570.019**

Laparoscopes 10 mm distortion-free

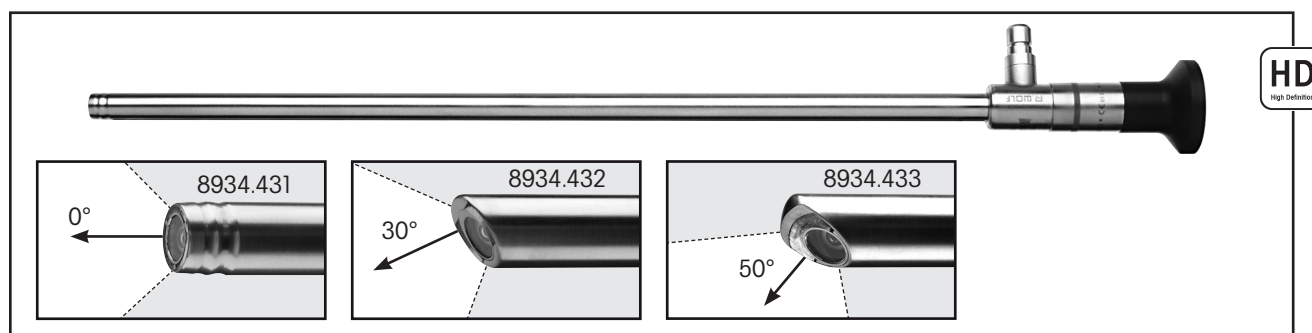

PANOVIEW telescope, Ø 10 mm, distortion-free

0°, 307 mm WL	8934.431
30°, 307 mm WL	8934.432
50°, 310 mm WL	8934.433

Recommended light cable:

Fusion fiber light cable bundle, Ø 5.0 mm, 3 m long **806550301**

consisting of:

Fiber light cable (80655030), adapter projector side (8095.07) and adapter endoscope side (809509)

Accessories:

Single scope tray **8570.017**

Double scope tray **8570.010**

LAPAROSCOPES

Laparoscopes 10 mm bariatric length

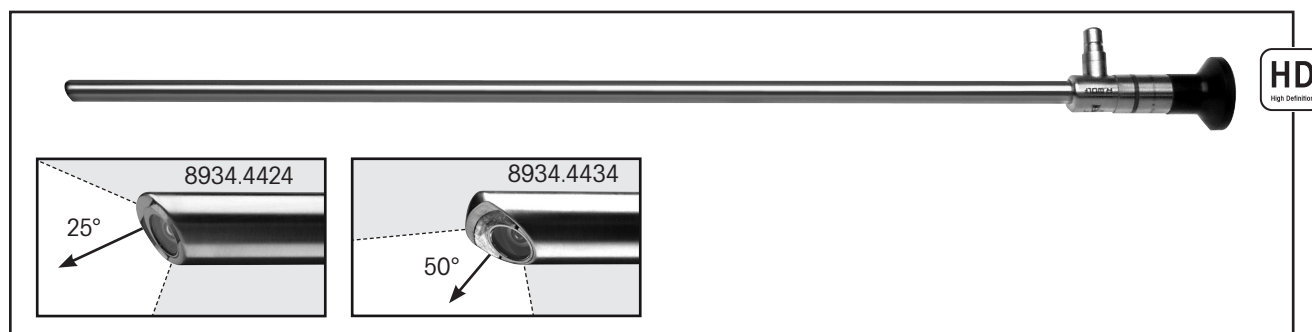

PANOVIEW telescope, Ø 10 mm

25°, 438 mm WL	8934.4424
50°, 447 mm WL	8934.4434

Recommended light cable:

Fusion fiber light cable bundle, Ø 5.0 mm, 3 m long **806550301**

consisting of:

Fiber light cable (80655030), adapter projector side (8095.07) and adapter endoscope side (809509)

Accessories:

Single scope tray **8570.019**

Telescopes 10 mm

Optimized for 4K UHD and NIR/ICG applications

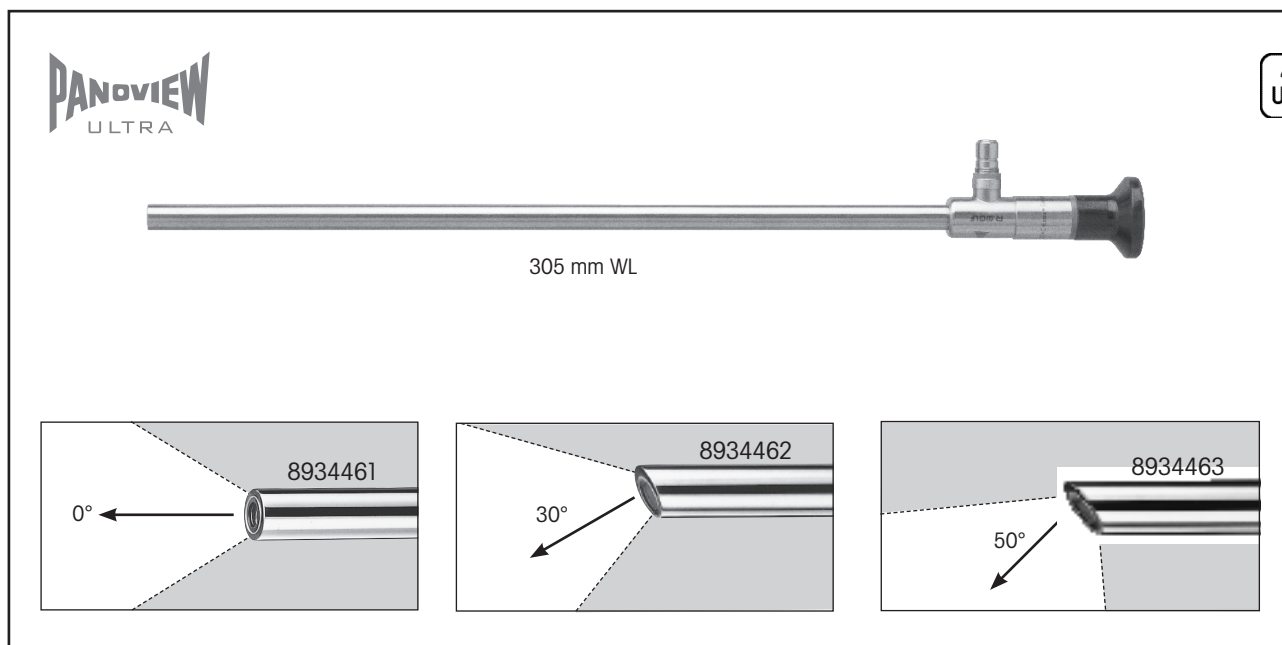

LAPAROSCOPES

PANOVIEW ULTRA telescope, Ø 10 mm, 305 mm WL

0°	8934461
30°	8934462
50°	8934463

Fusion fiber light cable bundle, Ø 5.0 mm, 3.0 m long.....806550301

consisting of:

Fusion fiber light cable (80655030), adapter projector side (8095.07) and adapter endoscope side (809509)

Accessories:

Single scope tray.....8570.017

Double scope tray.....8570.010

Note: Compatible with System green (NIR/ICG capable)

Telescopes 10 mm

Optimized for 4K UHD and NIR/ICG applications

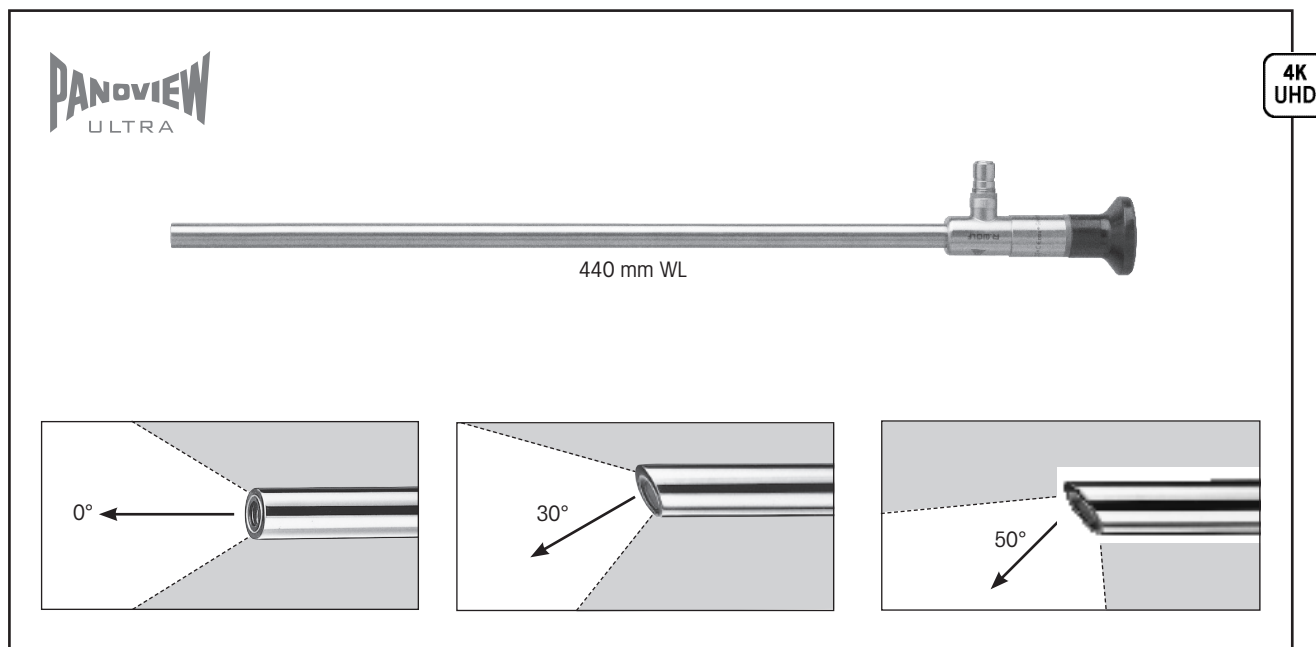

LAPAROSCOPES

PANOVIEW ULTRA telescope, Ø 10 mm, 440 mm WL

0°	89344416
30°	89344426
50°	89344436

Fusion fiber light cable bundle, Ø 5.0 mm, 3 m long.....806550301

consisting of:

Fusion fiber light cable (80655030), adapter projector side (8095.07) and adapter endoscope side (809509)

Accessories:

Single scope tray.....8570.019

Note: Compatible with System green (NIR/ICG capable)

INSUFFLATOR Highflow 45 BASIC



- 6.5" color display
- Touchscreen
- Max. flow rate 45 l / min
- Functional and user-friendly design

INSUFFLATOR Highflow 45 BASIC bundle **223560155**

consisting of:

INSUFFLATOR Highflow 45 Basic (2235601), power cord (N710171), CO₂ pressure tube (74021.029), CO₂ pressure reducer (74007.055) and hose assembly (RWM-284)

Accessories:

- CO₂ Pressure reducer** DIN EN ISO 407 **74007.055**
- Insufflation tube**, disposable with integrated hygiene filter, pack of 10, in individual sterile packs **4170.501**
- Hygiene filter**, sterile pack of 10 **4171.111**
- Hose assembly**, for CO₂ wall source **RWM-284**

INSUFFLATION

INSUFFLATOR

Highflow 45 BASIC

Technical data

Protection class complying with IEC / EN 60601-1; (UL 60601-1 / CSA C22.2 No.601.1 - for USA)	1
Electromagnetic compatibility (EMC)	according to EN 60601-1-2
Medical Device Directive 93/42/EEC	Class IIb
Protection against electric shock	Application part of Type CF
Degree of protection against penetration of liquids	IP 20 (not protected)
Duty cycle	Continuous operation
Degree of protection when flammable mixtures are present	This device is not protected against explosions (Do not operate this device in areas where explosive substances are present)
Weight	8.9 kg (19.5 lbs)
Dimensions (W x H x D)	300 mm x 160 mm x 455 mm
Voltage	100 - 240 V~ / a.c.
Frequency	50 / 60 Hz
Power consumption	60 VA
Fuse	T 3.15 H
Power rating	0.6 - 0.2 A

Relevant application parameters:

Insufflation medium	med. CO ₂ (purity > 99.5 %)
Intra-abdominal pressure	3 mmHg to 25 mmHg, (± 2 mmHg) preselectable in 1 mmHg steps
Gas flow rate: - primary filling - high flow	1 l/min. 2 l/min. to 45 l/min. (± 20 %) preselectable in 1 l/min steps
Consumption display	0 l to 9999 l (± 20 %)

INSUFFLATOR Highflow 45 EVAC



- 6.5" color display
- Touchscreen
- Max. flow rate 45 l / min
- Functional and user-friendly design
- Smoke evacuation

INSUFFLATOR Highflow 45 EVAC bundle **223561155**

consisting of:

INSUFFLATOR Highflow 45 EVAC (2235611), power cable (N710171), CO₂ pressure tube (74021.029), CO₂ pressure reducer (74007.055) and hose assembly (RWM-284)

Accessories:

CO₂ Pressure reducer DIN EN ISO 407 **74007.055**

Disposable tube set for smoke evacuation, sterile, pack of 10 **4170503**

Insufflation tube, disposable with integrated hygiene filter, pack of 10, in individual sterile packs **4170.501**

Hygiene filter, sterile pack of 10 **4171.111**

Hose assembly, for CO₂ wall source **RWM-284**

Smoke evacuation foot pedal **20301031**

INSUFFLATION

INSUFFLATOR

Highflow 45 EVAC

Technical data

Protection class complying with IEC / EN 60601-1; (UL 60601-1 / CSA C22.2 No.601.1 - for USA)	1
Electromagnetic compatibility (EMC)	according to EN 60601-1-2
Medical Device Directive 93/42/EEC	Class IIb
Protection against electric shock	Application part of Type CF
Degree of protection against penetration of liquids	IP 20 (not protected)
Duty cycle	Continuous operation
Degree of protection when flammable mixtures are present	This device is not protected against explosions (Do not operate this device in areas where explosive substances are present)
Weight	8.9 kg (19.5 lbs)
Dimensions (W x H x D)	300 mm x 160 mm x 455 mm
Voltage	100 - 240 V~ / a.c.
Frequency	50 / 60 Hz
Power consumption	60 VA
Fuse	T 3.15 H
Power rating	0.6 - 0.2 A

Relevant application parameters:

Insufflation medium	med. CO ₂ (purity > 99.5 %)
Intra-abdominal pressure	3 mmHg to 25 mmHg, (± 2 mmHg) preselectable in 1 mmHg steps
Gas flow rate: - primary filling - high flow	1 l/min. 2 l/min. to 45 l/min. (± 20 %) preselectable in 1 l/min steps
Consumption display	0 l to 9999 l (± 20 %)

Passive Smoke-Evacuation Filter for smoke discharge

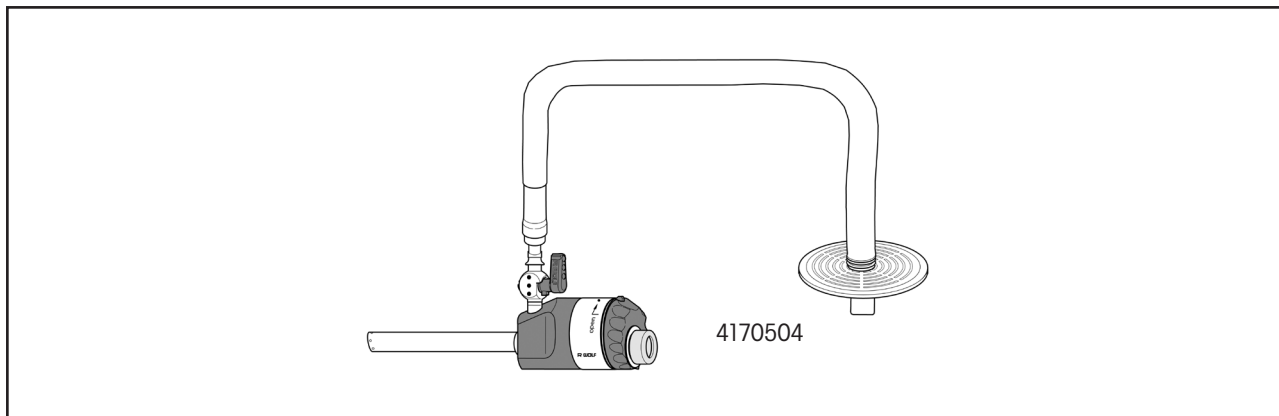

Passive smoke-evacuation filter*, sterile, pack of 10..... **4170504**

* For direct connection to trocar, as an alternative to active smoke evacuation

Veres Cannulas for establishing the pneumoperitoneum

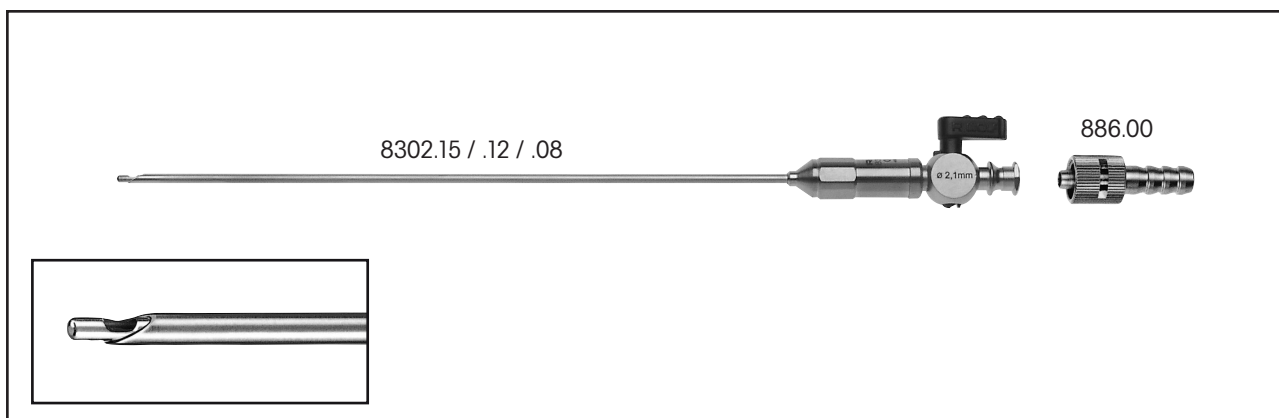



Veres cannulas



150 mm working length	8302.15
120 mm working length (standard length)	8302.12
80 mm working length	8302.08

Accessories:

Luer connector	886.00
-----------------------------	---------------

Trocar Sleeves 2 mm





Trocar sleeve with insufflation connector				Trocar, pyramidal tip	
					
	WL	Capacity	Types		
Metal sleeve, standard, straight distal tip		100 mm	2 mm	8309.014	8309.123

Trocar sleeve				Trocar, pyramidal tip	
					
	WL	Capacity	Types		
Plastic sleeve with retaining thread, straight distal tip		60 mm	2 mm	8309.072	8309.121

Accessories:

Spare sealing caps, pack of 10 **88.01**









Trocar Sleeves 3.5 mm

RWO-ART trocar sleeves with magnetic-ball-valve with insufflation tap					
					
	WL	Capacity	Types		
Metal sleeve, standard, straight distal tip 	100 mm	3.5 mm	8903.014	8903.103	8903.123
Plastic sleeve, retaining thread, straight distal tip 	60 mm	3.5 mm	8903.072	8903.101	8903.121
	100 mm	3.5 mm	8903.034	8903.103	8903.123

Accessories:

Spare ball , 1 piece, capacity Ø 3.5 mm - 5.5 mm	8921.901
Spare o-rings , pack of 10, capacity Ø 3.5 mm - 5.5 mm	8921.951
Spare sealing caps , pack of 10, capacity 3.5 mm, red	89.01
Spare stopcocks , pack of 5	896.0002

Trocar Sleeves 5.5 mm

RWO-ART trocar sleeves with magnetic-ball-valve with insufflation tap				Trocar, blunt conical tip	Trocar, conical tip	Trocar, pyramidal tip
						
	WL	Capacity	Types			
Metal sleeve, standard, straight distal tip 	100 mm	5.5 mm	8921.014	8921.103	8921.113	8921.123
	150 mm	5.5 mm	8921.016	8921.105	8921.115	8921.125
Metal sleeve, standard, oblique distal tip 	100 mm	5.5 mm	8921.013	8921.103	8921.113	8921.123
Metal sleeve, retaining thread, straight distal tip 	100 mm	5.5 mm	8921.024	8921.103	8921.113	8921.123
	150 mm	5.5 mm	8921.026	8921.105	8921.115	8921.125
Metal sleeve, retaining thread, oblique distal tip 	100 mm	5.5 mm	8921.023	8921.103	8921.113	8921.123
Plastic sleeve, retaining thread, straight distal tip 	100 mm	5.5 mm	8921.034	8921.103	8921.113	8921.123

Accessories:







Spare ball, 1 piece, capacity Ø 3.5 mm - 5.5 mm **8921.901**

Spare o-rings, pack of 10, capacity Ø 3.5 mm - 5.5 mm **8921.951**

Spare sealing caps, pack of 10, capacity 5.5 mm, blue **89.02**

Spare stopcocks, pack of 5 **896.0002**



Trocar Sleeves 5.5 mm

RWO-ART trocar sleeves with magnetic-ball-valve					Trocar, blunt conical tip	Trocar, conical tip	Trocar, pyramidal tip
							
	WL	Capacity	Types				
Metal sleeve, standard, straight distal tip 	60 mm	5.5 mm	8921.052	8921.101	8921.111	8921.121	
Metal sleeve, standard, oblique distal tip 	60 mm	5.5 mm	8921.051	8921.101	8921.111	8921.121	
Metal sleeve, retaining thread, straight distal tip 	60 mm	5.5 mm	8921.062	8921.101	8921.111	8921.121	

Accessories:

Spare ball , 1 piece, capacity Ø 3.5 mm - 5.5 mm	8921.901
Spare o-rings , pack of 10, capacity Ø 3.5 mm - 5.5 mm	8921.951
Spare sealing caps , pack of 10, capacity 5.5 mm, blue	89.02





Flexible Trocar Sleeves 5.5 mm for curved instruments

				Trocar, pyramidal tip	Trocar, ball shaped
					
	WL	Capacity	Types		
Plastic sheath with retaining thread, straight distal tip, incl. membrane valves 89.103 (pack of 10)	62 mm	5.8 mm	8905.331		8905.3315
	102 mm	5.8 mm	8905.351	8905.3513	8905.3515

Accessories:

Membrane valves, yellow, pack of 10 **89.103**

Trocar Sleeves 5.5 mm plastic with membrane seal



					Trocar, blunt conical tip	Trocar, conical tip	Trocar, pyramidal tip
							
	WL	Capacity	with stopcock	Types			
Plastic sheath with retaining thread, straight distal tip, incl. membrane valves 89.103 (pack of 10)	65 mm	5.5 mm	●	8919.333	8919.3311	8919.3312	8919.3313
		5.5 mm		8919.331			
	105 mm	5.5 mm	●	8919.353	8919.3511	8919.3512	8919.3513
		5.5 mm		8919.351			

Accessories:



Membrane valves, yellow, pack of 10 **89.103**



Spare stopcocks, pack of 5 **896.0002**

Trocar Sleeve 5.5 mm



Flexible trocar sleeve, plastic				Trocar, blunt conical tip	
					
	WL	Capacity	Types		
Oblique distal tip	 75 mm	5.5 mm	8906.051	8906.151	

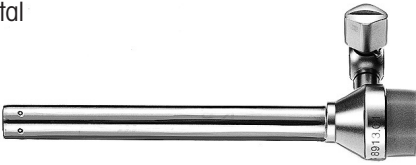

Trocar Sleeves 7 mm



Flexible trocar sleeve, plastic				Trocar, blunt conical tip	
					
	WL	Capacity	Types		
Straight distal tip	 75 mm	7 mm	8906.001	8913.11	

Trocar sleeve with lateral tap, metal				Trocar, blunt conical tip	
					
	WL	Capacity	Types		
Straight distal tip	 75 mm	7 mm	8913.01	8913.11	





Trocar Sleeves 10 mm-18 mm

Flexible trocar sleeve, plastic				Trocar, blunt conical tip	
					
	WL	Capacity	Types		
Straight distal tip	60 mm	10 mm	8906.011	8906.111	

Flexible trocar sleeve, plastic				Trocar, blunt conical tip	
					
	WL	Capacity	Types		
Straight distal tip	60 mm	12.5 mm	8906.031	8906.131	

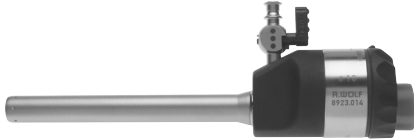
Trocar sleeve, metal, oval				Trocar, blunt conical tip	
					
	WL	Capacity	Types		
Straight distal tip	55 mm	13.6 / 18 mm	8906.081	8906.181	

Trocar Sleeves 10 mm with insufflation tap

RWO-ART trocar sleeves with magnetic-ball-valve					Trocar, blunt conical tip	Trocar, conical tip	Trocar, pyramidal tip
							
	WL	Capacity	Types				
Metal sleeve, standard, straight distal tip	100 mm	10 mm	8923.014	8923.103	8923.113	8923.123	
	150 mm	10 mm	8923.016	-	8923.115	8923.125	
Metal sleeve, standard, oblique distal tip	100 mm	10 mm	8923.013	8923.103	8923.113	8923.123	
Metal sleeve, retaining thread, straight distal tip	100 mm	10 mm	8923.024	8923.103	8923.113	8923.123	
	150 mm	10 mm	8923.026	-	8923.115	8923.125	
Metal sleeve, retaining thread, oblique distal tip	100 mm	10 mm	8923.023	8923.103	8923.113	8923.123	





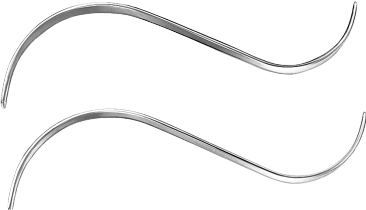

Accessories:

Spare ball , 1 piece, capacity Ø 7 mm - 12.5 mm	8923.901
Spare o-rings , pack of 10, capacity Ø 7 mm - 12.5 mm	8923.951
Spare sealing caps , pack of 10, capacity 10 mm, red	89.08
Spare stopcocks , pack of 5	896.0002

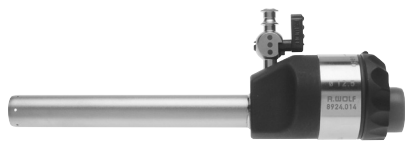
	To expose anatomical layers: Tissue retractors , S-shaped, set of two	8928.90
---	--	----------------

TROCARS

Trocar Sleeves 12.5 mm with insufflation tap

RWO-ART trocar sleeves with magnetic-ball-valve					Trocar, blunt conical tip	Trocar, conical tip	Trocar, pyramidal tip
							
		WL	Capacity	Types			
Metal sleeve, standard, straight distal tip		100 mm	12.5 mm	8924.014	8924.103	8924.113	8924.123
		150 mm	12.5 mm	8924.016	-	8924.115	8924.125
Metal sleeve, standard, oblique distal tip		100 mm	12.5 mm	8924.013	8924.103	8924.113	8924.123
Metal sleeve, retaining thread, straight distal tip		150 mm	12.5 mm	8924.026	-	8924.115	8924.125

Accessories:

VARIO-PORT reducing adapter

for reduction from:

Ø 10 mm to Ø 5.5 mm and

Ø 12.5 mm to Ø 5.5 mm, pack of 5 **8923.802**



TROCARS

Dilatation and Extraction Instruments

3.5 mm to 5.5 mm / 5.5 mm to 10 mm

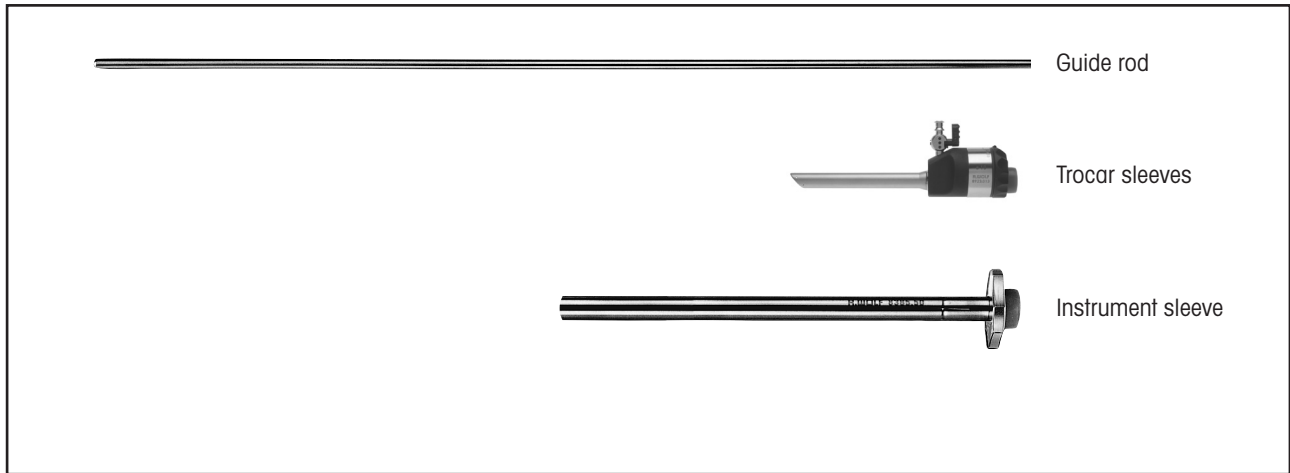

To extend an incision	Guide rod	Trocar sleeve	Instrument sleeve, extractor and reducing sleeve
3.5 mm to 5.5 mm	-	8921.013	8383.78*
5.5 mm to 10 mm	8934.951	8923.013 (5.5 mm to 10 mm)	-

* For sealed application of 3.5 mm instruments in the 5.5 mm trocar sleeve

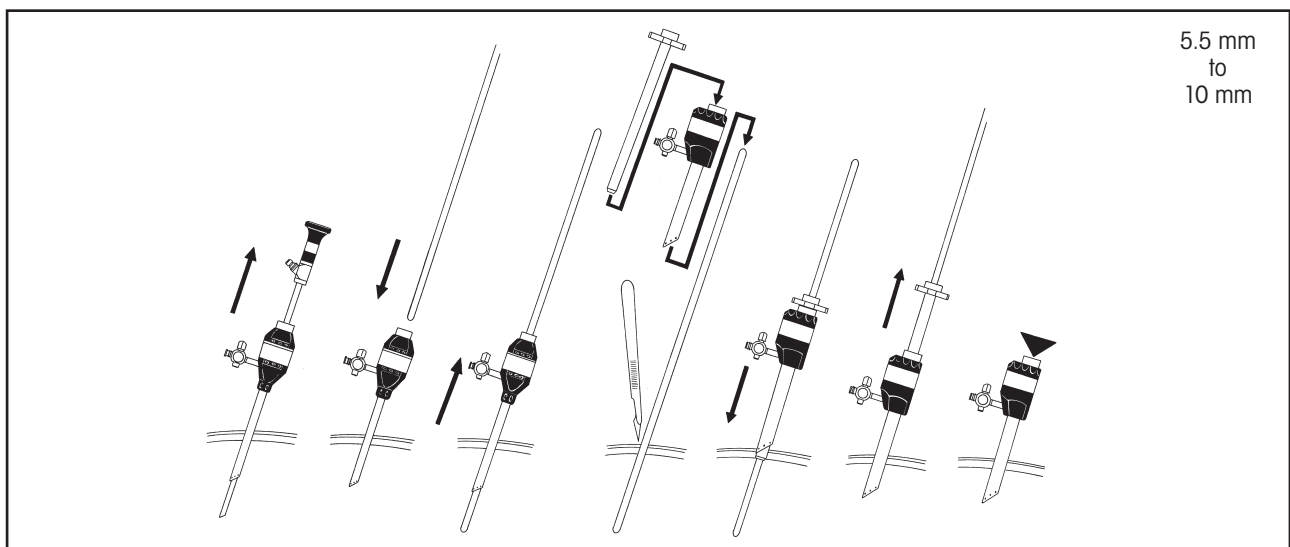

TROCARS

Reducing Sleeve for RIWO-ART trocar sleeves

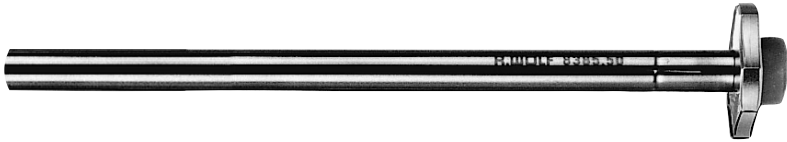







	Outer Ø	WL	for instrument sizes	Types
5.5/3.5 mm Reducing sleeve*	5.5 mm	160 mm	3.5 mm	8383.78







Accessories:

***Spare sealing caps**, pack of 10..... **89.02**

ERAGON modular
mini

modular instruments 3.5 mm, insulated

	Handle type				Knob attachment, ERAGONaxial 	
	 <p>with locking mechanism, rotatable</p>	 <p>without locking mechanism, rotatable</p>	 <p>with locking mechanism, rotatable</p>	 <p>with locking mechanism, non rotatable</p>		
<p>All jaw inserts and sheaths can also be combined with ERAGONaxial.</p>	Product No.	83930082	83930083	83930084	83930085	8988







Jaw insert 	Sheath tube, insulated 		Handle type HF / mono  <p>with locking mechanism, rotatable</p>	Complete instrument • Jaw Insert • Sheath • Handle
	WL 240 mm	WL 330 mm		
Product No.	8390933	8391933	83930074	Bundle No.
 <p>Grasping and dissecting forceps long, fine tip, double jaw action, JL= 18 mm</p>	●	●	●	8390221 8391221
 <p>Grasping and dissecting forceps short, fine tip, double jaw action, JL= 14 mm</p>	●	●	●	8390222 8391222
 <p>Grasping and dissecting forceps curved right, double jaw action, JL= 14 mm</p>	●	●	●	8390223 8391223







* JL = Jaw length when jaws closed (approximate measurements)

HF connecting cable see page 124.

ERAGON modular
mini

modular instruments 3.5 mm, insulated

	Handle type				Knob attachment, ERAGONaxial 	
	 <p>with locking mechanism, rotatable</p>	 <p>without locking mechanism, rotatable</p>	 <p>with locking mechanism, rotatable</p>	 <p>with locking mechanism, non rotatable</p>		
<p>All jaw inserts and sheaths can also be combined with ERAGONaxial.</p>	Product No.	83930082	83930083	83930084	83930085	8988



Jaw insert 	Sheath tube, insulated 		Handle type HF / mono 	Complete instrument <ul style="list-style-type: none"> • Jaw Insert • Sheath • Handle 	
	WL 240 mm	WL 330 mm	with locking mechanism, rotatable		
	Product No.	8390933	8391933	83930074	Bundle No.
	8390207	●		●	83902077
Grasping and dissecting forceps, long, fine tip, double jaw action, JL= 15mm	8391207		●	●	83912077
	8390216	●		●	83902167
Double-spoon forceps, by Hürtgen, double jaw action, JL= 12 mm	8391216		●	●	83912167
	8390217	●		●	83902177
Punch by Friedel, single jaw action, JL= 10 mm	8391217		●	●	83912177







* JL = Jaw length when jaws closed (approximate measurements)

HF connecting cable see page 124.

ERAGON modular
mini

modular scissors 3.5 mm, insulated

 All jaw inserts and sheaths can also be combined with ERAGONaxial.	Handle type HF / mono  without locking mechanism, rotatable		Knob attachment, ERAGONaxial 
	Product No.	83930083	8988





Jaw insert 	Sheath tube, insulated 		Handle type HF / mono  without locking mechanism, rotatable	Complete instrument • Jaw Insert • Sheath • Handle
	WL 240 mm	WL 330 mm		
 Scissors "Metzenbaum", double jaw action, JL= 16 mm	●		●	83902157
	●	●	●	83912157
 Scissors "Metzenbaum", fine serrated, curved, double jaw action, JL= 14 mm	●		●	83902247
	●	●	●	83912247
 Hook scissors, single jaw action, JL= 8 mm	●		●	83902277
	●	●	●	83912277







* JL = Jaw length when jaws closed (approximate measurements)

HF connecting cable see page 124.

ERAGON modular
mini

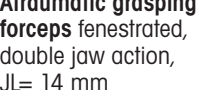
modular instruments 3.5 mm, non-insulated

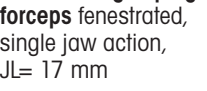

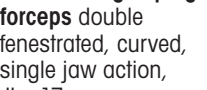

 All jaw inserts and sheaths can also be combined with ERAGONaxial.	Handle type		Knob attachment, ERAGONaxial 
	 with locking mechanism, rotatable	 with locking mechanism, non rotatable	
Product No.	83930082	83930085	8988





Jaw insert 	Sheath tube, non-insulated		Handle type  with locking mechanism, rotatable	Complete instrument • Jaw Insert • Sheath • Handle
	WL 240 mm	WL 330 mm		
Product No.	8390934	8391934	83930072	Bundle No.
 Atraumatic grasping forceps fenestrated, double jaw action, JL= 14 mm	●		●	83902087
 Atraumatic grasping forceps fenestrated, single jaw action, JL= 14 mm		●	●	83912087
 Atraumatic grasping forceps fenestrated, single jaw action, JL= 17 mm	●		●	83902187
 Atraumatic grasping forceps double fenestrated, curved, single jaw action, JL= 17 mm		●	●	83912187
 Atraumatic grasping forceps double fenestrated, curved, single jaw action, JL= 17 mm	●		●	83902257
 Atraumatic grasping forceps double fenestrated, curved, single jaw action, JL= 17 mm		●	●	83912257

* JL = Jaw length when jaws closed (approximate measurements)

ERAGON modular
mini

modular instruments 3.5 mm, non-insulated





 All jaw inserts and sheaths can also be combined with ERAGONaxial.	Handle type		Knob attachment, ERAGONaxial 
	 with locking mechanism, rotatable	 with locking mechanism, non rotatable	
Product No.	83930082	83930085	8988





Jaw insert	Sheath tube, non-insulated		Handle type	Complete instrument
	WL 240 mm	WL 330 mm		
 Product No.	8390934	8391934	83930072	Bundle No.
 Atraumatic grasping forceps fenestrated, double jaw action, JL= 19 mm	8390226	●	●	83902267
	8391226		●	83912267
 Grasping and dissecting forceps, double jaw action, JL= 13 mm	8390219	●	●	83902197
	8391219		●	83912197
 Grasping and dissecting forceps 2x4 teeth, double jaw action, JL= 14 mm	8390220	●	●	83902207
	8391220		●	83912207

* JL = Jaw length when jaws closed (approximate measurements)

ERAGON modular
mini

modular instruments 3.5 mm, non-insulated





 All jaw inserts and sheaths can also be combined with ERAGONaxial.	Handle type		Knob attachment, ERAGONaxial 
	 with locking mechanism, rotatable	 with locking mechanism, non rotatable	
Product No.	83930082	83930085	8988







Jaw insert 	Sheath tube, non-insulated		Handle type  with locking mechanism, rotatable	Complete instrument • Jaw Insert • Sheath • Handle
	WL 240 mm	WL 330 mm		
Product No.	8390934	8391934	83930072	Bundle No.
 Universal grasping forceps, double jaw action, JL= 14 mm	8390209	●	●	83902097
	8391209		●	83912097
 Grasping forceps "Babcock", double jaw action, JL= 19 mm	8390210	●	●	83902107
	8391210		●	83912107

* JL = Jaw length when jaws closed (approximate measurements)

ERAGON modular

modular instruments 5 mm, insulated

ERAGON axial	Handle type				Knob attachment, ERAGONaxial
		HF / mono 	HF / mono 		
All jaw inserts and sheaths can also be combined with ERAGONaxial.	with locking mechanism, rotatable	without locking mechanism, rotatable	with locking mechanism, rotatable	with locking mechanism, non rotatable	
Product No.	83930082	83930083	83930084	83930085	8988

Jaw insert 	Sheath tube, insulated 		Handle type HF / mono  with locking mechanism, rotatable	Complete instrument • Jaw Insert • Sheath • Handle
	WL 330 mm	WL 450 mm		
Product No.	8393933	8394933	83930074	Bundle No.
 Grasping and dissecting forceps "Maryland" curved, with fine cross-cut toothing, double jaw action, JL= 21 mm	8393.281	•	•	83932817
	8394.281	•	•	83942817
 Grasping and dissecting forceps long, double jaw action, JL= 24 mm	8393194	•	•	83931947
	8394194	•	•	83941947
 Grasping and dissecting forceps curved, double jaw action, JL= 19 mm	8393240	•	•	83932407
	8394240	•	•	83942407





* JL = Jaw length when jaws closed (approximate measurements)





HF connecting cable see page 124.

ERAGON

ERAGON modular

modular instruments 5 mm, insulated

ERAGON axial	Handle type				Knob attachment, ERAGONaxial
		HF / mono 	HF / mono 		
All jaw inserts and sheaths can also be combined with ERAGONaxial.	with locking mechanism, rotatable	without locking mechanism, rotatable	with locking mechanism, rotatable	with locking mechanism, non rotatable	
Product No.	83930082	83930083	83930084	83930085	8988

Jaw insert 	Sheath tube, insulated		Handle type HF / mono 	Complete instrument • Jaw Insert • Sheath • Handle	
	WL 330 mm	WL 450 mm			
	Product No.	8393933	8394933	83930074	Bundle No.
 Grasping and dissecting forceps "Mixer" angled, fine pyramidal-shaped teeth, double jaw action, JL= 22 mm	8393.283	●		●	83932837
 Grasping and dissecting forceps right-angled, double jaw action, JL= 18 mm	8393192	●		●	83931927
	8394192		●	●	83941927
 Grasping and dissecting forceps short, fine tip, double jaw action, JL= 19 mm	8393200	●		●	83932007
	8394200		●	●	83942007







* JL = Jaw length when jaws closed (approximate measurements)







HF connecting cable see page 124.

ERAGON

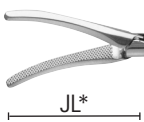
ERAGON modular

modular instruments 5 mm, insulated

	Handle type				Knob attachment, ERAGONaxial 	
	 with locking mechanism, rotatable	 without locking mechanism, rotatable	 with locking mechanism, rotatable	 with locking mechanism, non rotatable		
All jaw inserts and sheaths can also be combined with ERAGONaxial.	Product No.	83930082	83930083	83930084	83930085	8988





Jaw insert  JL*	Sheath tube, insulated 		Handle type HF / mono  with locking mechanism, rotatable	Complete instrument • Jaw Insert • Sheath • Handle	
	Product No.	WL 330 mm			WL 450 mm
 Grasping and dissecting forceps long, double jaw action, JL= 30 mm	8393197	●		●	83931977
	8394197		●	●	83941977
 Grasping forceps curved, fine tip, double jaw action, JL= 33 mm	8393198	●		●	83931987
	8394198		●	●	83941987
 Grasping and dissecting forceps long, fine tip, double jaw action, JL= 32 mm	8393199	●		●	83931997
	8394199		●	●	83941997







* JL = Jaw length when jaws closed (approximate measurements)

HF connecting cable see page 124.

ERAGON modular

modular instruments 5 mm, insulated

ERAGON axial	Handle type				Knob attachment, ERAGONaxial
		HF / mono 	HF / mono 		
All jaw inserts and sheaths can also be combined with ERAGONaxial.	with locking mechanism, rotatable	without locking mechanism, rotatable	with locking mechanism, rotatable	with locking mechanism, non rotatable	
Product No.	83930082	83930083	83930084	83930085	8988





Jaw insert 	Sheath tube, insulated 	Handle type		Complete instrument • Jaw Insert • Sheath • Handle
		HF / mono 	HF / mono 	
	WL 330 mm	without locking mechanism, rotatable	with locking mechanism, rotatable	
Product No.	8393933	83930073	83930074	Bundle No.
 Grasping and dissecting forceps , fine pyramid-shaped toothing, slimline, double jaw action, JL= 18 mm	●		●	83932897
 Dissecting forceps, "Petelin" , angled 30° left, with horizontal serration, single jaw action, JL= 17 mm	●		●	83932827
 Grasping and dissecting forceps, "Dolphin" angled, fine cross-cut toothing, with jaw throat, slimline, double jaw action, JL=17 mm	●	●		83932857







* JL = Jaw length when jaws closed (approximate measurements)

HF connecting cable see page 124.

ERAGON modular

modular instruments 5 mm, insulated

ERAGON axial	Handle type				Knob attachment, ERAGONaxial
		HF / mono 	HF / mono 		
All jaw inserts and sheaths can also be combined with ERAGONaxial.	with locking mechanism, rotatable	without locking mechanism, rotatable	with locking mechanism, rotatable	with locking mechanism, non rotatable	
Product No.	83930082	83930083	83930084	83930085	8988





Jaw insert 	Sheath tube, insulated 			Handle type		Complete instrument • Jaw Insert • Sheath • Handle	
	WL 260 mm	WL 330 mm	WL 450 mm		HF / mono 		
	Product No.	8392933	8393933	8394933	83930072	83930074	Bundle No.
 Grasping and dissecting forceps , short rounded jaws, double jaw action, JL= 15 mm	8393230		●		●		83932307
	8394230			●	●		83942307
 Atraumatic grasping forceps , fenestrated, with cross-cut tothing, double jaw action, JL= 19 mm	8392.181	●				●	83921817
	8393.181		●			●	83931817
	8394.181			●		●	83941817
 Plate-shaped grasping forceps , fenestrated with fine cross-cut tothing, double jaw action, JL= 18 mm	8393.182		●			●	83931827







* JL = Jaw length when jaws closed (approximate measurements)

HF connecting cable see page 124.

ERAGON modular

modular instruments 5 mm, insulated

ERAGON axial	Handle type				Knob attachment, ERAGONaxial
		HF / mono 	HF / mono 		
All jaw inserts and sheaths can also be combined with ERAGONaxial.	with locking mechanism, rotatable	without locking mechanism, rotatable	with locking mechanism, rotatable	with locking mechanism, non rotatable	
Product No.	83930082	83930083	83930084	83930085	8988





Jaw insert 	Sheath tube, insulated 		Handle type HF / mono		Complete instrument • Jaw Insert • Sheath • Handle
	WL 330 mm	WL 450 mm			
Product No.	8393933	8394933	83930073	83930074	Bundle No.
 Grasping and dissecting forceps , fine cross-cut toothing, double jaw action, JL= 21 mm	●		●		83931837
 Grasping and dissecting forceps , fenestrated, fine horizontal serrations, single jaw action, JL= 21 mm	●			●	83931857
 Grasping and dissecting forceps , fenestrated, fine horizontal serrations, single jaw action, JL= 26 mm	●			●	83931847
	8394.184		●	●	83941847







* JL = Jaw length when jaws closed (approximate measurements)

HF connecting cable see page 124.

ERAGON modular

modular instruments 5 mm, insulated

ERAGON axial	Handle type				Knob attachment, ERAGONaxial
		HF / mono 	HF / mono 		
All jaw inserts and sheaths can also be combined with ERAGONaxial.	with locking mechanism, rotatable	without locking mechanism, rotatable	with locking mechanism, rotatable	with locking mechanism, non rotatable	
Product No.	83930082	83930083	83930084	83930085	8988

Jaw insert 	Sheath tube, insulated 		Handle type 	Complete instrument • Jaw Insert • Sheath • Handle
	WL 330 mm	WL 450 mm		
Product No.	8393933	8394933	83930072	Bundle No.
 Grasping forceps atraumatic, fenestrated, fine cross toothing, double jaw action, JL= 25 mm	8393250	•	•	83932507
	8394250	•	•	83942507
 Atraumatic grasping forceps with double window, curved, single jaw action, JL= 32 mm	8393229	•	•	83932297
	8394229	•	•	83942297
 Atraumatic intestinal grasping forceps , single fenestration, double jaw action, JL= 38 mm	8393249	•	•	83932497
	8394249	•	•	83942497





* JL = Jaw length when jaws closed (approximate measurements)







HF connecting cable see page 124.

ERAGON

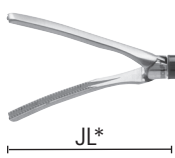
ERAGON modular

modular instruments 5 mm, insulated

ERAGON axial	Handle type				Knob attachment, ERAGONaxial
		HF / mono 	HF / mono 		
All jaw inserts and sheaths can also be combined with ERAGONaxial.	with locking mechanism, rotatable	without locking mechanism, rotatable	with locking mechanism, rotatable	with locking mechanism, non rotatable	
Product No.	83930082	83930083	83930084	83930085	8988

Jaw insert 	Sheath tube, insulated		Handle type		Complete instrument • Jaw Insert • Sheath • Handle	
	WL 330 mm	WL 450 mm		HF / mono 		
	Product No.	8393933	8394933	83930072	83930074	Bundle No.
 Grasping forceps "Debaquey" curved, double jaw action, JL= 35 mm	8393256	●			●	83932567
 Grasping forceps "Debaquey" double jaw action, JL= 47 mm	8393258	●			●	83932587
	8394258		●		●	83942587
 Grasping and dissecting forceps, fine cross-cut toothing, fenestrated, double jaw action, with spring jaws, JL= 47 mm	8393.189	●		●		83931897
	8394.189		●	●		83941897





* JL = Jaw length when jaws closed (approximate measurements)







HF connecting cable see page 124.

ERAGON

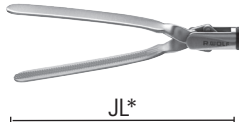
ERAGON modular

modular instruments 5 mm, insulated

ERAGON axial	Handle type				Knob attachment, ERAGONaxial
		HF / mono 	HF / mono 		
All jaw inserts and sheaths can also be combined with ERAGONaxial.	with locking mechanism, rotatable	without locking mechanism, rotatable	with locking mechanism, rotatable	with locking mechanism, non rotatable	
Product No.	83930082	83930083	83930084	83930085	8988







Jaw insert	Sheath tube, insulated	Handle type	Complete instrument
	 WL 330 mm	 with locking mechanism, rotatable	<ul style="list-style-type: none"> Jaw Insert Sheath Handle
Product No.	8393933	83930072	Bundle No.
 Grasping and dissecting forceps "Debakey" , atraumatic clip, longitudinal grooves with fine cross-cut toothing, double jaw action, with spring jaws, JL= 47 mm	●	●	83932917
 Grasping and dissecting forceps "Debakey" , atraumatic clip, double jaw action, JL= 39 mm	●	●	83931907
 Grasping and dissecting forceps "Debakey" , atraumatic clip, double jaw action, JL= 48 mm	●	●	83931917







* JL = Jaw length when jaws closed (approximate measurements)

HF connecting cable see page 124.

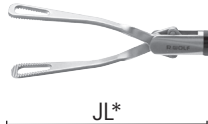
ERAGON modular

modular instruments 5 mm, insulated

	Handle type				Knob attachment, ERAGONaxial 	
	 <p>with locking mechanism, rotatable</p>	 <p>without locking mechanism, rotatable</p>	 <p>with locking mechanism, rotatable</p>	 <p>with locking mechanism, non rotatable</p>		
<p>All jaw inserts and sheaths can also be combined with ERAGONaxial.</p>	Product No.	83930082	83930083	83930084	83930085	8988





Jaw insert 	Sheath tube, insulated 		Handle type  <p>with locking mechanism, rotatable</p>	Complete instrument <ul style="list-style-type: none"> • Jaw Insert • Sheath • Handle 			
	WL 330 mm	WL 450 mm			Product No.	8393933	8394933
 <p>Grasping and extraction forceps, triangular, fenestrated, with fine cross-cut toothing, double jaw action, with spring jaws, JL= 37 mm</p>	●	●	●	●	8393.188	●	83931887
 <p>Grasping forceps "Babcock", grasping surface with fine cross-cut toothing, double jaw action, JL= 24 mm</p>	●	●	●	●	8393.186	●	83931867
 <p>Grasping forceps "Babcock", grasping surface with fine cross-cut toothing, double jaw action, JL= 26 mm</p>	●	●	●	●	8393.187	●	83931877
	●	●	●	●	8394.187	●	83941877







* JL = Jaw length when jaws closed (approximate measurements)

HF connecting cable see page 124.

ERAGON modular

modular instruments 5 mm, insulated

ERAGON axial	Handle type				Knob attachment, ERAGONaxial
		HF / mono 	HF / mono 		
All jaw inserts and sheaths can also be combined with ERAGONaxial.	with locking mechanism, rotatable	without locking mechanism, rotatable	with locking mechanism, rotatable	with locking mechanism, non rotatable	
Product No.	83930082	83930083	83930084	83930085	8988





Jaw insert 	Sheath tube, insulated 		Handle type		Complete instrument • Jaw Insert • Sheath • Handle	
	WL 330 mm	WL 450 mm		HF / mono 		
	Product No.	8393933	8394933	83930072	83930074	Bundle No.
 Grasping forceps, fenestrated, single jaw action, JL= 17 mm	8393242	●		●		83932427
	8394242		●	●		83942427
 Universal grasping forceps pyramid-shaped toothings and cross-cut toothings, double jaw action, JL= 18 mm	8393.481	●			●	83934817
 Universal holding forceps pyramid-shaped toothings and cross-cut toothings, double jaw action, JL= 26 mm	8393.482	●		●		83934827







* JL = Jaw length when jaws closed (approximate measurements)

HF connecting cable see page 124.

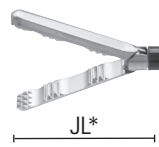
ERAGON modular

modular instruments 5 mm, insulated

ERAGON axial	Handle type				Knob attachment, ERAGONaxial
		HF / mono 	HF / mono 		
All jaw inserts and sheaths can also be combined with ERAGONaxial.	with locking mechanism, rotatable	without locking mechanism, rotatable	with locking mechanism, rotatable	with locking mechanism, non rotatable	
Product No.	83930082	83930083	83930084	83930085	8988

Jaw insert  JL*	Sheath tube, insulated 		Handle type  with locking mechanism, rotatable	Complete instrument • Jaw Insert • Sheath • Handle
	WL 330 mm	WL 450 mm		
Product No.	8393933	8394933	83930072	Bundle No.
 8393223	●		●	83932237
Grasping forceps , atraumatic, fine cross-cut tothing, double jaw action, JL= 29 mm		●	●	83942237
 8393.292	●		●	83932925
Atraumatic grasping forceps , jaw throat with wavy tooth edge, single jaw action, JL= 26 mm		●	●	839429255
 8393.293	●		●	83932935
Atraumatic grasping forceps , jaw throat with wavy tooth edge, double jaw action, JL= 26 mm		●	●	839329355





* JL = Jaw length when jaws closed (approximate measurements)







HF connecting cable see page 124.

ERAGON

ERAGON modular

modular instruments 5 mm, insulated

ERAGON axial	Handle type				Knob attachment, ERAGONaxial
		HF / mono 	HF / mono 		
All jaw inserts and sheaths can also be combined with ERAGONaxial.	with locking mechanism, rotatable	without locking mechanism, rotatable	with locking mechanism, rotatable	with locking mechanism, non rotatable	
Product No.	83930082	83930083	83930084	83930085	8988





Jaw insert	Sheath tube, insulated	Handle type	Complete instrument
	 WL 330 mm	HF / mono  with locking mechanism, rotatable	• Jaw Insert • Sheath • Handle
Product No.	8393933	83930074	Bundle No.
 Grasping and dissecting forceps , fine pyramid-shaped toothings, slimline, double jaw action, JL= 14 mm	●	●	83932887
 Grasping forceps , with row of teeth, double jaw action, JL= 17 mm	●	●	83934857
 Grasping and dissecting forceps , atraumatic, fine cross toothings, double jaw action, JL= 16 mm	●	●	83932107









* JL = Jaw length when jaws closed (approximate measurements)

HF connecting cable see page 124.

ERAGON modular

modular instruments 5 mm, insulated

ERAGON axial	Handle type				Knob attachment, ERAGONaxial
		HF / mono 	HF / mono 		
All jaw inserts and sheaths can also be combined with ERAGONaxial.	with locking mechanism, rotatable	without locking mechanism, rotatable	with locking mechanism, rotatable	with locking mechanism, non rotatable	
Product No.	83930082	83930083	83930084	83930085	8988





Jaw insert 	Sheath tube, insulated 		Handle type			Complete instrument • Jaw Insert • Sheath • Handle
	WL 330 mm	WL 450 mm				
Product No.	8393933	8394933	83930072	83930073	83930074	Bundle No.
	8393193	•	•			83931937
Grasping and dissecting forceps, double jaw action, JL= 16 mm	8394193		•	•		83941937
	8393220	•			•	83932207
Grasping and dissecting forceps atraumatic, double jaw action, JL= 19 mm	8394220		•		•	83942207
	8393.195	•			•	83931957
Atraumatic grasping forceps smooth, double jaw action, JL= 18 mm	8394.195		•		•	83941957







* JL = Jaw length when jaws closed (approximate measurements)

HF connecting cable see page 124.

ERAGON modular

modular instruments 5 mm, insulated

ERAGON axial	Handle type				Knob attachment, ERAGONaxial
		HF / mono 	HF / mono 		
All jaw inserts and sheaths can also be combined with ERAGONaxial.	with locking mechanism, rotatable	without locking mechanism, rotatable	with locking mechanism, rotatable	with locking mechanism, non rotatable	
Product No.	83930082	83930083	83930084	83930085	8988





Jaw insert	Sheath tube, insulated	Handle type	Complete instrument
	 WL 330 mm	HF / mono  with locking mechanism, rotatable	• Jaw Insert • Sheath • Handle
Product No.	8393933	83930074	Bundle No.
 Grasping forceps, with one tooth, fine cross-cut toothing, slimline, double jaw action, JL= 19 mm	●	●	83934867
 Grasping forceps, with two teeth, fine cross-cut toothing, single jaw action, JL= 17 mm	●	●	83934877
 Grasping and extraction forceps, "pike-mouth", double jaw action, JL= 20 mm	●	●	83934837







* JL = Jaw length when jaws closed (approximate measurements)

HF connecting cable see page 124.

ERAGON modular

modular instruments 5 mm, insulated

ERAGON axial	Handle type				Knob attachment, ERAGONaxial
		HF / mono 	HF / mono 		
All jaw inserts and sheaths can also be combined with ERAGONaxial.	with locking mechanism, rotatable	without locking mechanism, rotatable	with locking mechanism, rotatable	with locking mechanism, non rotatable	
Product No.	83930082	83930083	83930084	83930085	8988





Jaw insert 	Sheath tube, insulated 		Handle type 	Complete instrument • Jaw Insert • Sheath • Handle
	WL 330 mm	WL 450 mm		
Product No.	8393933	8394933	83930072	Bundle No.
 Grasping and extraction myoma grasping forceps , 2x3-claw, single jaw action, JL= 29 mm	8393.488	●	●	83934887
 Grasping forceps with two teeth , wavy grasping surface atraumatic, double jaw action, JL= 26 mm	8393.490	●	●	83934907
	8394.490	●	●	83944907
 Claw grasping forceps , double jaw action, JL= 47 mm	8393.494	●	●	83934945





* JL = Jaw length when jaws closed (approximate measurements)

HF connecting cable see page 124.

ERAGON modular

modular instruments 5 mm, insulated

ERAGON axial	Handle type				Knob attachment, ERAGONaxial
		HF / mono 	HF / mono 		
All jaw inserts and sheaths can also be combined with ERAGONaxial.	with locking mechanism, rotatable	without locking mechanism, rotatable	with locking mechanism, rotatable	with locking mechanism, non rotatable	
Product No.	83930082	83930083	83930084	83930085	8988







Jaw insert 	Sheath tube, insulated		Handle type HF / mono 	Complete instrument • Jaw Insert • Sheath • Handle
	WL 330 mm	WL 450 mm		
Product No.	8393933	8394933	83930073	Bundle No.
 Grasping coagulating forceps , distal cross-cut toothing with cupped jaw, double jaw action, JL= 15 mm	8393.287	●	●	83932877
 Biospy forceps , with pins, double jaw action, JL= 13 mm	8393.091	●	●	83930917
	8394.091	●	●	83940917
 Biospy forceps , severing, single jaw action, JL= 14 mm	8393.092	●	●	83930927
	8394.092	●	●	83940927





* JL = Jaw length when jaws closed (approximate measurements)

HF connecting cable see page 124.

ERAGON modular

modular instruments 5 mm, insulated

 All jaw inserts and sheaths can also be combined with ERAGONaxial.	Handle type				Knob attachment, ERAGONaxial 
	 with locking mechanism, rotatable	HF / mono  without locking mechanism, rotatable	HF / mono  with locking mechanism, rotatable	 with locking mechanism, non rotatable	
Product No.	83930082	83930083	83930084	83930085	8988



Jaw insert 	Sheath tube, insulated  WL 330 mm	Handle type HF / mono  without locking mechanism, rotatable	Complete instrument <ul style="list-style-type: none"> • Jaw Insert • Sheath • Handle
Product No.	8393933	83930073	Bundle No.
 Biospy forceps , pointed spoon forceps, single jaw action, JL= 20 mm	8393.093	●	●







* JL = Jaw length when jaws closed (approximate measurements)

HF connecting cable see page 124.

ERAGON modular

modular scissors 5 mm, insulated

 All jaw inserts and sheaths can also be combined with ERAGONaxial.	Handle type HF / mono  without locking mechanism, rotatable		Knob attachment, ERAGONaxial 
	Product No.	83930083	8988



Jaw insert  JL*	Sheath tube, insulated 		Handle type HF / mono  without locking mechanism, rotatable	Complete instrument • Jaw Insert • Sheath • Handle
	WL 330 mm	WL 450 mm		
 Scissors "Metzenbaum", curved, double jaw action, JL= 23 mm	●	●	●	83930417
8393.041	●	●	●	83940417
8394.041	●	●	●	83932437
 Scissors "Metzenbaum", curved, double jaw action, JL= 21.2 mm	●	●	●	83942437
8393243	●	●	●	83930447
8394243	●	●	●	83930447
 Micro-scissors "Metzenbaum", curved double jaw action, JL= 18 mm	●	●	●	83930447
8393.044	●	●	●	83930447







* JL = Jaw length when jaws closed (approximate measurements)

HF connecting cable see page 124.

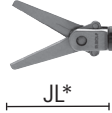
ERAGON modular

modular scissors 5 mm, insulated

 All jaw inserts and sheaths can also be combined with ERAGONaxial.	Handle type HF / mono  without locking mechanism, rotatable		Knob attachment, ERAGONaxial 
	Product No.	83930083	8988

Jaw insert 	Sheath tube, insulated 		Handle type HF / mono  without locking mechanism, rotatable	Complete instrument • Jaw Insert • Sheath • Handle
	WL 330 mm	WL 450 mm		
 Scissors slimline, straight, double jaw action, JL= 20 mm	●		●	83930457
 Scissors fine-toothed, curved, double jaw action, JL= 26 mm	●		●	83932467
		●	●	83942467
 Scissors fine-toothed, fine tip, double jaw action, JL= 22 mm	●		●	83932487
		●	●	83942487



* JL = Jaw length when jaws closed (approximate measurements)





HF connecting cable see page 124.

ERAGON

ERAGON modular

modular scissors 5 mm, insulated

 All jaw inserts and sheaths can also be combined with ERAGONaxial.	Handle type HF / mono  without locking mechanism, rotatable		Knob attachment, ERAGONaxial 
	Product No.	83930083	8988





Jaw insert  JL*	Sheath tube, insulated 		Handle type HF / mono  without locking mechanism, rotatable	Complete instrument • Jaw Insert • Sheath • Handle
	WL 330 mm	WL 450 mm		
 Hook Scissors , serrated, single jaw action, JL= 14 mm	●	●	●	●
8393.081	●	●	●	●
8394.081	●	●	●	●



* JL = Jaw length when jaws closed (approximate measurements)

HF connecting cable see page 124.

ERAGON modular

modular knot pusher 5 mm, insulated

 All jaw inserts and sheaths can also be combined with ERAGONaxial.	Handle type		Knob attachment, ERAGONaxial 
	 with locking mechanism, rotatable	 with locking mechanism, non rotatable	
Product No.	83930082	83930085	8988

Jaw insert 	Sheath tube, insulated		Handle type  with locking mechanism, rotatable	Complete instrument • Jaw Insert • Sheath • Handle
	WL 330 mm	WL 450 mm		
Product No.	8393933	8394933	83930072	Bundle No.
 Extracorporeal knot pusher, with distal fork, double jaw action, JL= 17 mm	8393.345	•	•	83933457
	8394345		•	83943457



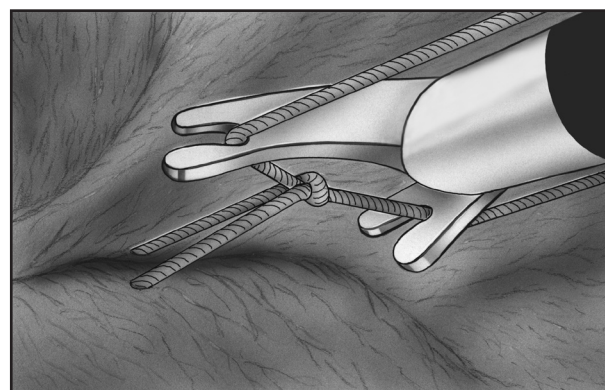

* JL = Jaw length when jaws closed (approximate measurements)







Extracorporeal knotting technique

ERAGON_{modular}

Gastric Band Manipulator 5 mm, insulated

 All jaw inserts and sheaths can also be combined with ERAGONaxial.	Handle type		Knob attachment, ERAGONaxial 
	 with locking mechanism, rotatable	 with locking mechanism, not rotatable	
Product No.	83930082	83930085	8988

Jaw insert   JL*	Sheath tube, insulated		Handle type		Complete instrument • Jaw insert • Sheath • Handle
		WL 330 mm	WL 450 mm	 with locking mechanism, rotatable	
Product No.	8393933	8394933	83930072		Bundle No.
 Gastric band manipulator, JL= 45 mm	8393253	●		●	83932537
	8394253		●	●	83942537

* JL = Jaw length when jaws closed (approximate measurements)

ERAGON modular



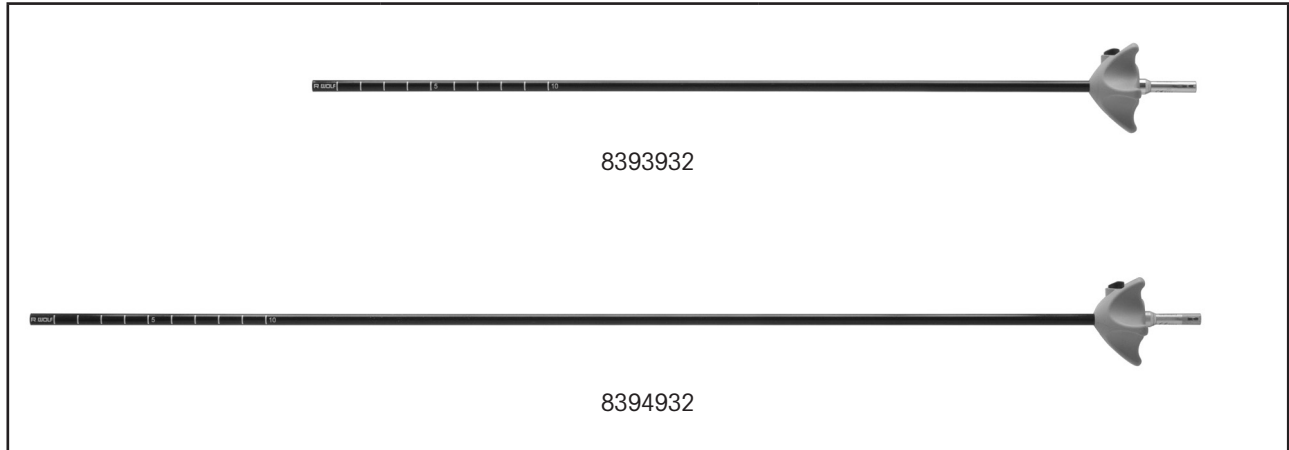

sheath tube with cm scale, insulated









	∅	WL	Product No.
 ERAGON modular sheath tube, monopolar, with distal cm scale	5 mm	330 mm	8393932
		450 mm	8394932

ERAGON modular

modular instruments 10 mm, non-insulated





 <p>All jaw inserts and sheaths can also be combined with ERAGONaxial.</p>	Handle type		Knob attachment, ERAGONaxial 
	 with locking mechanism, rotatable	 with locking mechanism, non rotatable	
Product No.	83930082	83930085	8988





Jaw insert 	Sheath tube, non-insulated		Handle type  with locking mechanism, rotatable	Complete instrument • Jaw Insert • Sheath • Handle	
	WL 330 mm	WL 450 mm			
	Product No.	8395902	8396902	83930072	Bundle No.
 Grasping and dissecting forceps "Maryland" , double jaw action, JL= 36 mm	8395.225	●		●	83952257
	8396225		●	●	83962257
 Dissecting forceps, right angled , double jaw action, JL= 35 mm	8395.226	●		●	83952268
	8396226		●	●	83962267
 Atraumatic grasping forceps "Babcock" , large distal grasping surface with fine horizontal serration, double jaw action, JL= 42 mm	8395.187	●		●	83951877
	8396187		●	●	83961877
 Atraumatic grasping forceps "Babcock" , double jaw action, JL= 38 mm	8395.214	●		●	83952148

* JL = Jaw length when jaws closed (approximate measurements)

ERAGON modular

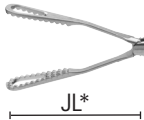
modular instruments 10 mm, non-insulated









 <p>All jaw inserts and sheaths can also be combined with ERAGONaxial.</p>	Handle type		Knob attachment, ERAGONaxial 
	 with locking mechanism, rotatable	 with locking mechanism, non rotatable	
Product No.	83930082	83930085	8988

Jaw insert 	Sheath tube, non-insulated		Handle type  with locking mechanism, rotatable	Complete instrument • Jaw Insert • Sheath • Handle	
	WL 330 mm	WL 450 mm			
	Product No.	8395902	8396902	83930072	Bundle No.
 Atraumatic plate-shaped grasping forceps, double jaw action, JL= 50 mm	8395.234	●		●	83952347
	8396234		●	●	83962347
 Grasping forceps, with alligator jaws double jaw action, JL= 20 mm	8395.236	●		●	83952368
	8396236		●	●	83962367
 Grasping forceps, 2x3 claw-shaped, JL= 49 mm	8395.204	●		●	83952048
	8396204		●	●	83952047

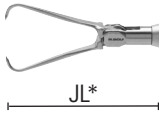
* JL = Jaw length when jaws closed (approximate measurements)

ERAGON modular





modular instruments 10 mm, non-insulated

ERAGON axial		Handle type		Knob attachment, ERAGONaxial	
		 with locking mechanism, rotatable	 with locking mechanism, non rotatable		
All jaw inserts and sheaths can also be combined with ERAGONaxial.		Product No.	83930082	83930085	8988
Jaw insert 	Sheath tube, non-insulated 	Handle type 		Complete instrument • Jaw Insert • Sheath • Handle	
Product No.	8395902	83930072			Bundle No.
 Claw-type grasping forceps , with additional row of teeth, double jaw action, JL= 38 mm	8395490	•	•	83954907	
 Claw grasping forceps , double jaw action, JL= 38 mm	8395.489	•	•	83954897	
 Spoon forceps , single jaw action, JL= 31 mm	8395.244	•	•	83952448	

* JL = Jaw length when jaws closed (approximate measurements)



ERAGON modular





modular instruments 10 mm, non-insulated

<p>Jaw insert</p> 	<p>ERAGON modular</p>	<p>Sheath tube, non-insulated</p>  <p>WL 380 mm</p>	<p>Handle type</p>  <p>with locking mechanism without HF connector</p>	<p>Complete instrument</p> <ul style="list-style-type: none"> • Jaw insert • Sheath • Handle
	Product No.	8397902	83930082	Bundle No.
	8397.655	●	●	83976558
<p>Anvil/Stapler head grasping forceps 30° angled, double jaw action</p>		●		839765572
	8397.654	●		83976547

* JL = Jaw length when jaws closed (approximate measurements)

Handle Type for modular systems

Handle type ERAGON_{modular}	mechanism, rotatable	with locking	without locking	with HF	without HF	Product No.
	•	•			•	83930072
	•		•	•		83930073
	•	•		•		83930074

Handle type ERAGON_{axial}	mechanism, rotatable	with locking	without locking	with HF	without HF	Product No.
	•	•			•	83930082
	•		•	•		83930083
	•	•		•		83930084
		•			•	83930085



Optional for 83930082 / 83930083 / 83930084:

Knob attachment





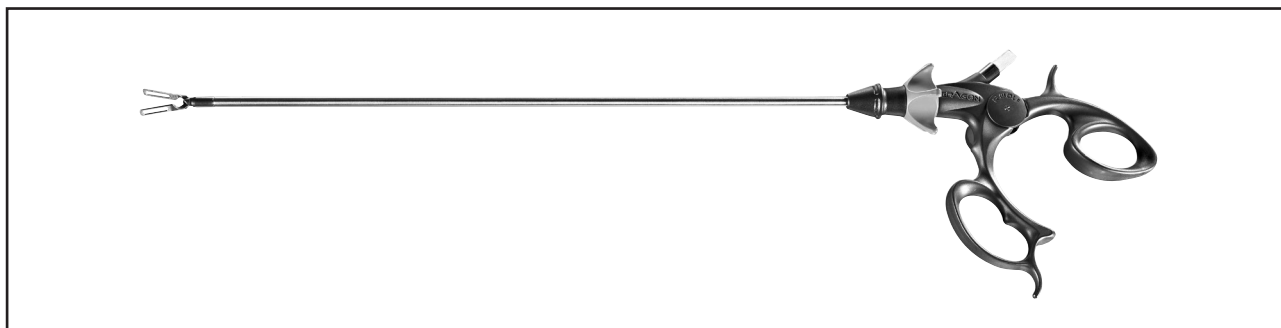

ERAGONaxial..... **8988**

All **ERAGON_{modular}** components are compatible with **ERAGON_{axial}**

ERAGON bipolar

modular bipolar instruments, 5.5 mm, rotatable



 JL*	Sheath		Complete instrument	
	WL 330 mm		<ul style="list-style-type: none"> • Jaw Insert • Sheath • Handle 	
	Product No.	83930921	839300102	Bundle No.
 Grasping and dissecting forceps, JL=21 mm	83930031	●	●	839300312
 Grasping and dissecting forceps "Maryland", JL= 23 mm	83930032	●	●	839300322
 Grasping and dissecting forceps "Dolphin", JL= 21 mm	83930033	●	●	839300332
 Grasping forceps, fenestrated, JL= 23 mm	83930034	●	●	839300342
 Dissecting forceps "Hasskamp", JL= 19 mm	83930035	●	●	839300352





* JL = Jaw length when jaws closed (approximate measurements)

Bipolar cable see page 125.

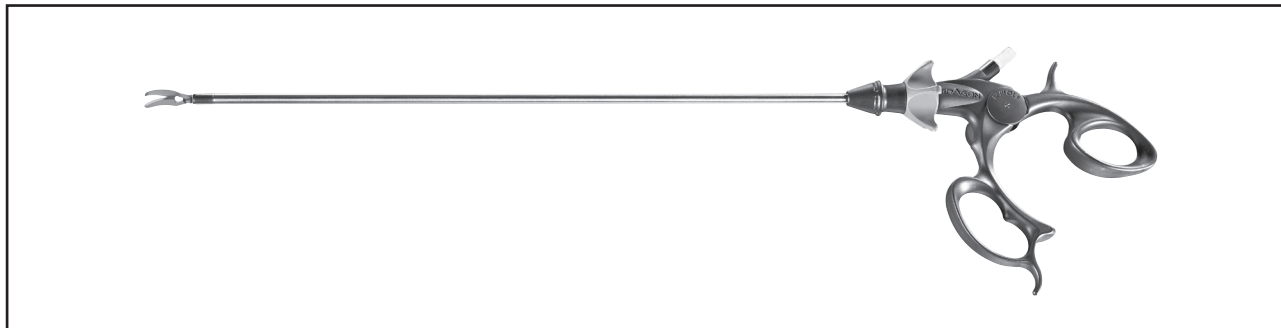
ERAGON bipolar

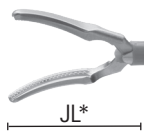
modular bipolar instruments, 5.5 mm, rotatable











<p>Jaw insert</p> 	<p>Sheath</p> 	<p>Handle, rotatable</p> 	<p>Complete instrument</p> <ul style="list-style-type: none"> • Jaw Insert • Sheath • Handle 	
	<p>WL 330 mm</p>			
	<p>Product No.</p>	<p>83930921</p>	<p>839300102</p>	<p>Bundle No.</p>
 <p>Metzenbaum scissors, JL= 22 mm</p>	<p>83930041</p>	<p>●</p>	<p>●</p>	<p>839300412</p>

* JL = Jaw length when jaws closed (approximate measurements)

Bipolar cable see page 125.

Needle Holder 3.5 mm / 5 mm modular system



 <p>Inner section with sheath tube and irrigation tap</p>				<p>Axial handle</p>  <ul style="list-style-type: none"> • one jaw opening • locking mechanism can be disabled 	<p>Complete instrument</p> <ul style="list-style-type: none"> • Inner section with sheath tube • Handle
	Product No.	Ø	WL	8393.941	Bundle No.
 <p>Modular needle holder, straight with carbide insert</p>	8391.504	3.5 mm	310 mm	●	8391.501
 <p>Modular needle holder, straight for straight needles</p>	8393.504	5 mm	320 mm	●	8393.501
 <p>Modular needle holder, straight with carbide insert</p>	8393.505	5 mm	320 mm	●	8393.502
<p>Modular needle holder, straight with carbide insert</p>	8394.505	5 mm	410 mm	●	8394.502
 <p>Modular needle holder, curved right with carbide insert</p>	8393.514	5 mm	320 mm	●	8393.511
<p>Modular needle holder, curved right with carbide insert</p>	8394.514	5 mm	410 mm	●	8394.511
 <p>Modular needle holder, curved left with carbide insert</p>	8393.515	5 mm	320 mm	●	8393.512
<p>Modular needle holder, curved left with carbide insert</p>	8394.515	5 mm	410 mm	●	8394.512
 <p>Modular multifunction* needle holder by Sarbu</p>	8393.506	5 mm	325 mm	●	8393.503
<p>Modular multifunction* needle holder by Sarbu</p>	8394.506	5 mm	415 mm	●	8394.503

* with automatic needle alignment mechanism and cutting edge

Grasping Forceps, 5 mm

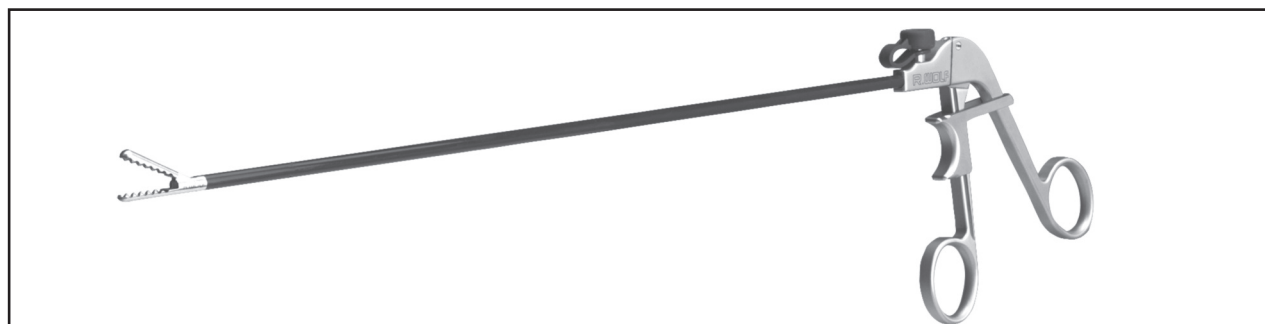
Single Piece Design, Slide-ratchet handle







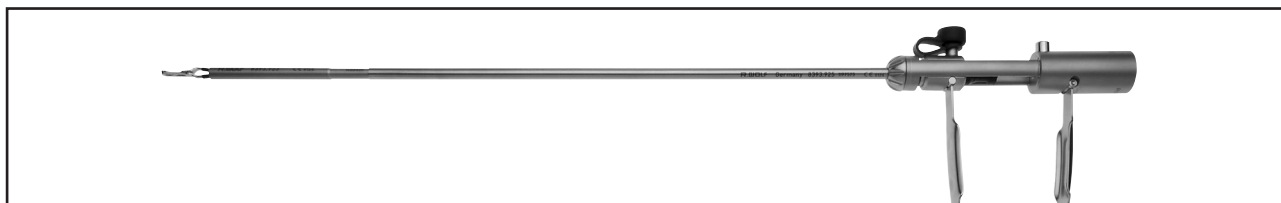

Instrument	310 mm WL	Non-Rotatable	Rotatable
 Wave Side Grasper, single action jaw	●	8383.2927	8383.2925
 Wave Side Grasper, double action jaw	●	8383.2937	8383.2935
 Retraction Grasper with two teeth	●	8383.4897	N/A

Ergonomic handle with slide-ratchet for secure positioning of the jaw tip

Bipolar Forceps 3.5 mm

with spring handle
modular system



Jaw insert	Outer tube	Screw-on cap with sleeve	Spring handle	Complete instrument	
	 WL 340 mm			<ul style="list-style-type: none"> • Jaw Insert • Outer tube • Screw-on cap • Spring handle 	
Product No.	8391.921	8393.978	8393.975	Bundle No.	
 Bipolar forceps	8391.715	●	●	●	8391.742

Spare parts:





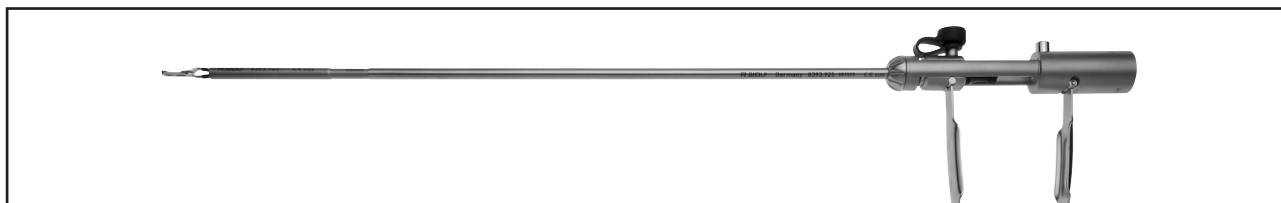

Rubber cap 15220.019
Luer sealing cap 15023.153

Bipolar connecting cable see page 125.

Bipolar Forceps 5 mm

with spring handle
modular system





Jaw insert	Outer tube	Screw-on cap with sleeve	Spring handle	Complete instrument	
	 WL 300 mm			<ul style="list-style-type: none"> • Jaw Insert • Outer tube • Screw-on cap • Spring handle 	
	Product No.	8393.923	8393.925	8393.975	Bundle No.
 Bipolar grasping forceps with Teflon tooth	8393.705	•	•	•	*
 Bipolar grasping forceps, Kleppinger principle	8393.714	•	•	•	8393.741

*No bundle number available. Components need to be quoted separately.

Bipolar connecting cable see page 125.

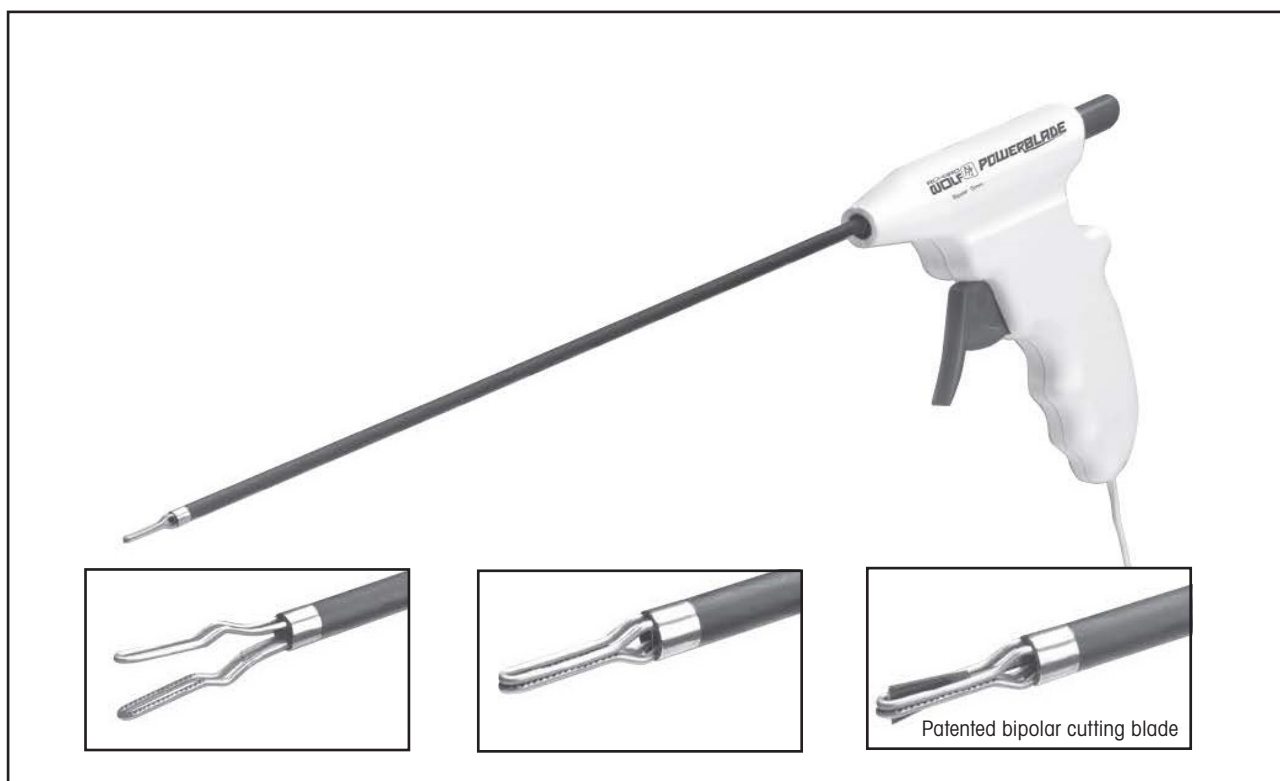
PowerBlade, Bipolar Forceps, 5 mm for bipolar cutting and coagulation



Connector for unit	Ø	WL	Quantity"	Product No.
 Connector for Richard Wolf generators	5 mm	310 mm	5/box	4393.3865
	5 mm	430 mm	5/box	4394.3865
 Connector for Valleylab, ConMed, ERBE style generators	5 mm	310 mm	5/box	4393.2865
	5 mm	430 mm	5/box	4394.2865

*Individually packed sterile, disposable.

Cholangiography Catheter Grasping Forceps 5 mm

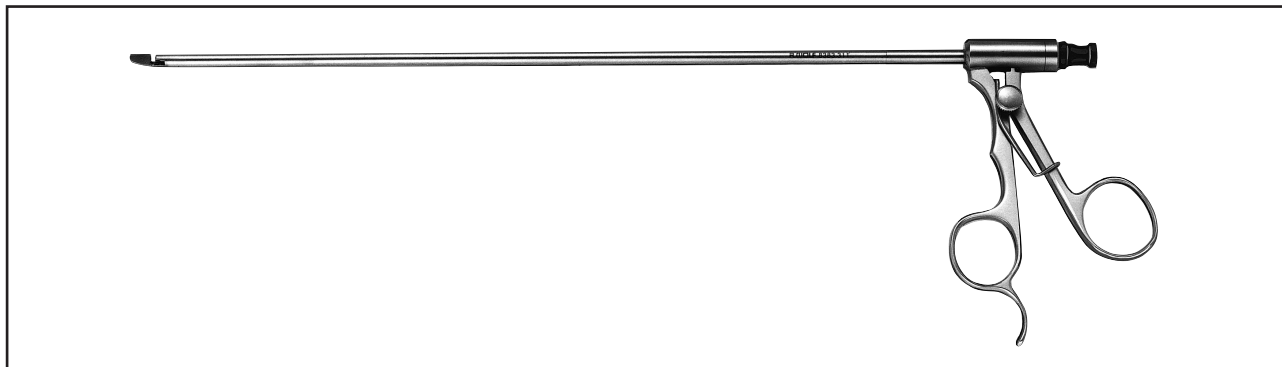

	WL 295 mm	Product No.
 Grasping forceps, for cholangiography catheter	●	8383.311

For introducing a cholangiography catheter up to 7 Fr. into the cystic duct.

BipoTrode 1.6 mm / 5 Fr. Bipolar Electrode

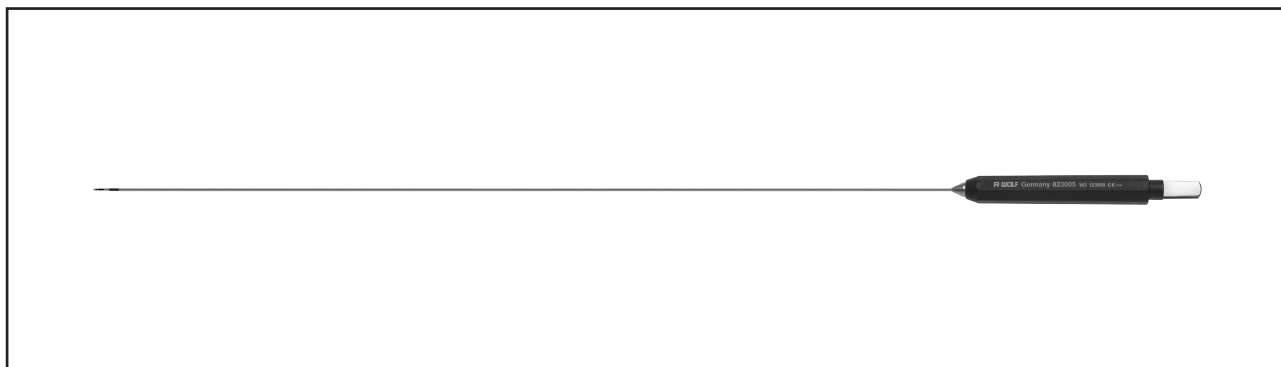



	WL 360 mm	Product No.
 BipoTrode bipolar electrode	●	823005

- ❑ For precise dissection, preparation and coagulation using saline distension media, also for use in laparoscopy (e.g. in combination with trocar sleeve 8309.072 with trocar 8309.121)
- ❑ Small diameter of 5 Fr. allows use with hysteroscopes
- ❑ Made of semiflexible stainless steel so can be used with bent working channels but preferably with straight working channels of the compact Richard WOLF hysteroscopes
- ❑ Robust and ergonomic handle

Electrodes 2 mm



monopolar

		
	WL 400 mm	Type
 Coagulation button electrode	●	823.06

LAPAROSCOPIC INSTRUMENTS

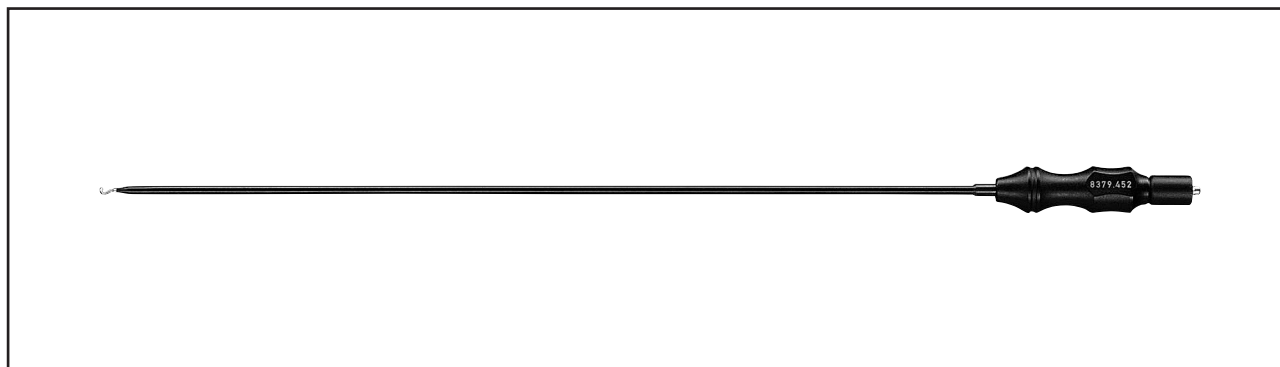
Electrodes 3.5 mm monopolar



	WL 340 mm	Product No.
 Hook electrode	●	8379.452
 Needle electrode	●	8379.482
 Coagulation button electrode	●	8379.462

HF connecting cable see page 124.

Electrodes 5 mm monopolar

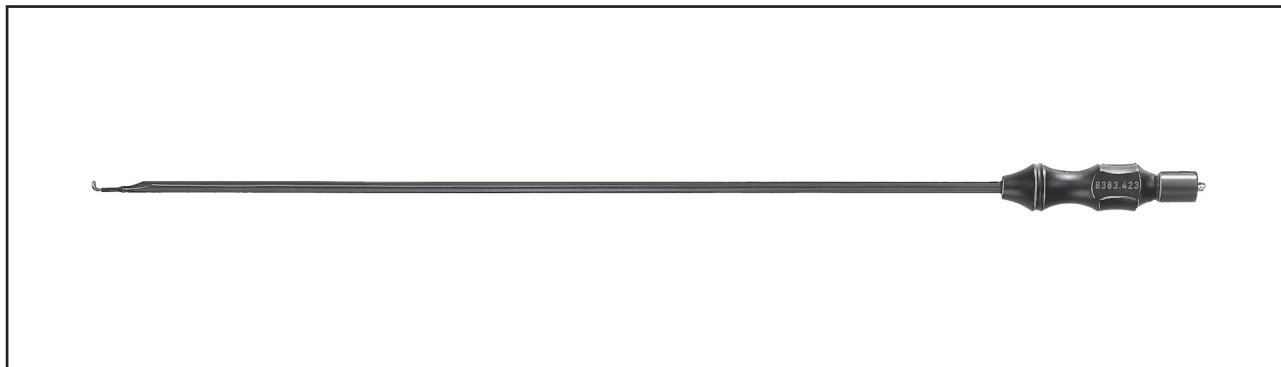

	WL 340 mm	WL 420 mm	WL 450 mm	Product No.
Hook electrode	●			8383.423
		●		8384.423
J-Hook electrode	●			8383.425
		●		8384.425
Myoma dissector	●			8383429
Needle electrode	●			8383.426
Spatula electrode	●			8383.428

HF connecting cable see page 124.

Electrodes 5 mm
monopolar

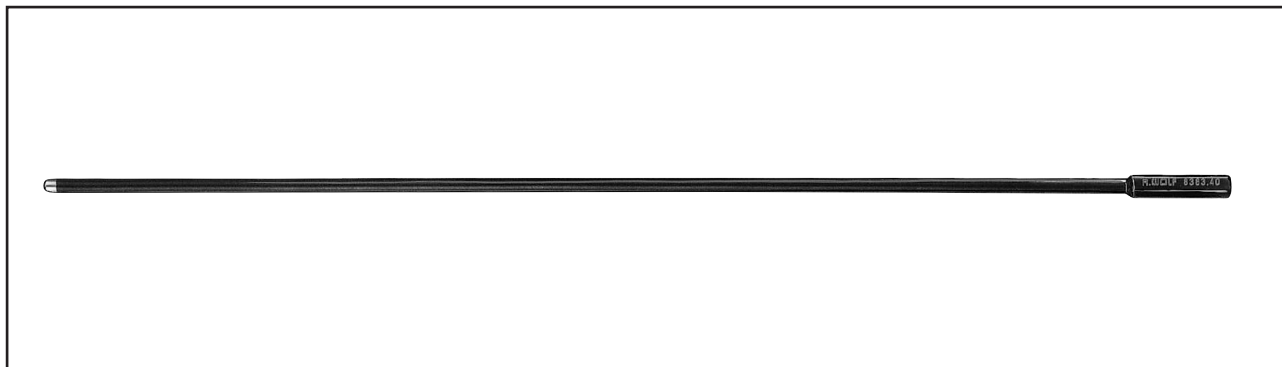

	WL 330 mm	WL 450 mm	Product No.
	●		8383.40
Button electrode		●	8384.40

LAPAROSCOPIC INSTRUMENTS

HF connecting cable see page 124.

Suction-Irrigation Tubes 5 mm with Luer connector



	WL 330 mm	Product No.
 Suction tube with Luer connector 3 mm capacity	●	8383.72

Suction Tube 5 mm with Luer connector and one valve

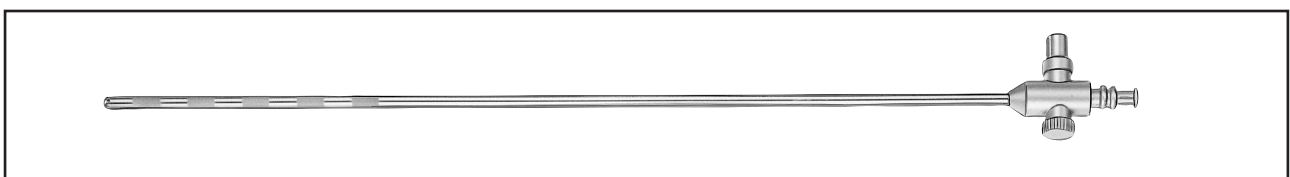

	WL 330 mm	WL 450 mm	Product No.
	●		8383.68
 Suction tube graduated, with Luer connector 3 mm		●	8384.68

LAPAROSCOPIC INSTRUMENTS

Combination Suction and Irrigation Tube 5 mm with two stop valves

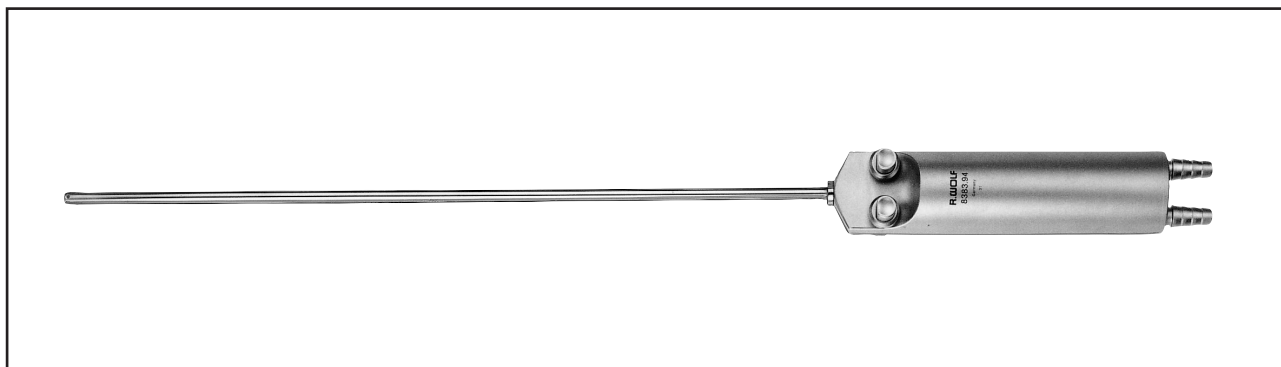

	WL 300 mm	Product No.
 Combination suction and irrigation tube with stop valves	●	8383.94

Coagulation-Suction Tubes 5 mm monopolar

with Luer connector and one valve





	WL 315 mm	WL 450 mm	Product No.
	●		8383.71*
Coagulation-suction tube , with Luer connector, capacity 3 mm		●	8384.71*

*HF connecting cables:

Wolf to Valleylab/ERBE	815.033
Wolf to ERBE T-series/Wolf	815.132

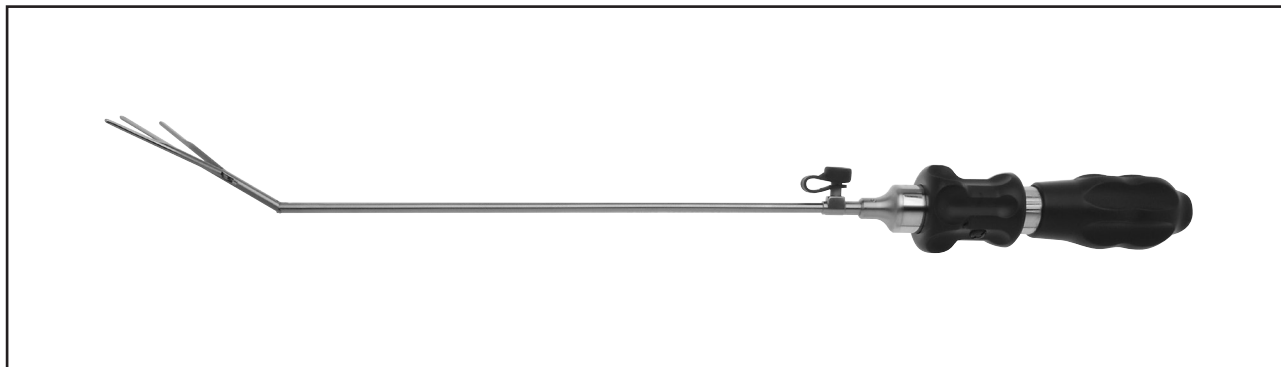
Tissue Retractor 5 mm



	WL 320 mm	Product No.
 <p>Tissue retractor, straight</p>	●	8383.691

- ❑ The extended hand of the surgeon
- ❑ Held in one hand
- ❑ Simple manipulation of tissue and organs
- ❑ Better view of concealed or difficult to access areas

Introducing Sleeve 10 mm

		Product No.
	<p>Introducing sleeve with sealing cap (89.08)</p>	<p>8389.991</p>

Knot Pusher 5 mm for endoscopic suturing

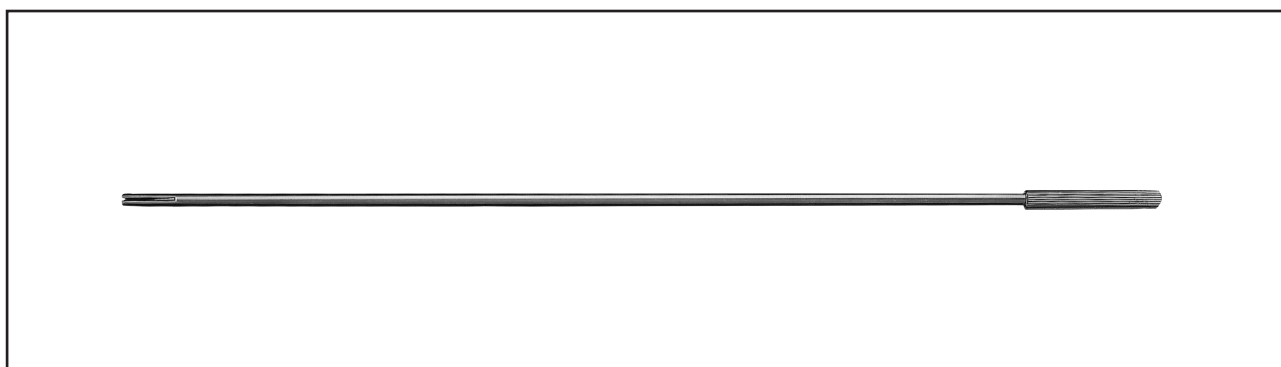



	WL 330 mm	Product No.
 Knot pusher , for intra-abdominal knots	●	8383.55

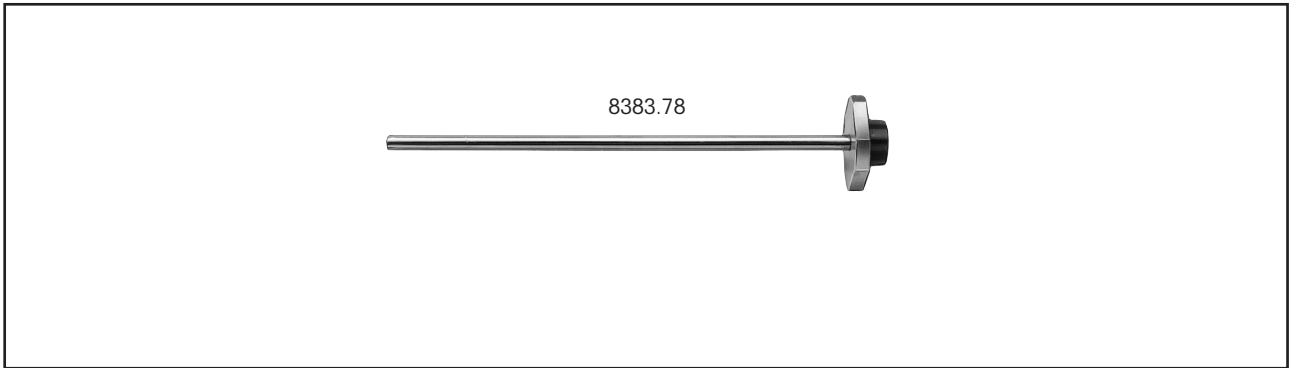

	WL 330 mm	Product No.
 Extracorporeal knot pusher by Bueß with distal notch and lateral opening for optimum knotting, extremely atraumatic tip for use as probe	●	8383.552

Applicator / Ligature Loops, 5 mm for endoscopic suturing



	WL 155 mm	Product No.
 Reducing sleeve with sealing cap*	●	8383.78

*For ligature loops or for introducing a suture with the 3 mm needle holder

Accessories:

Sealing caps, pack of 10, blue **89.02**

Trocar-Site Closure Device for visualized Fascia Closure by Busche

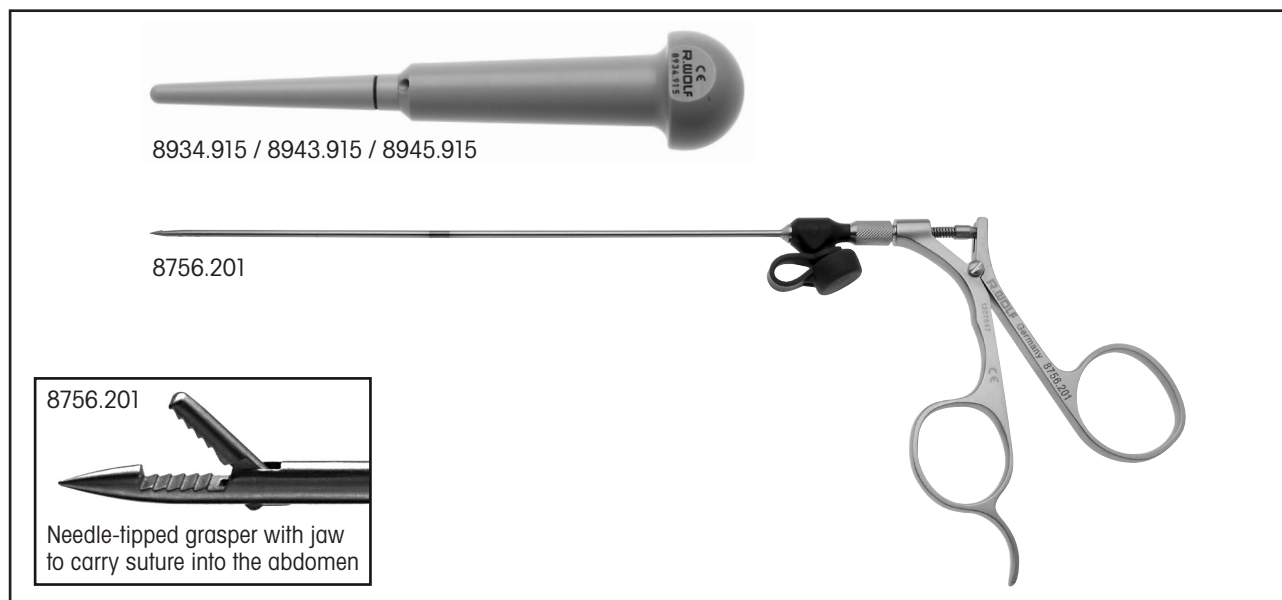

The extended tip of the device allows easy insertion of the cone which then effectively plugs the hole left when the cannula is removed. This preserves the pneumoperitoneum which can be maintained to ensure a safe distance between abdominal wall and the organs. The marking on the cone indicates the ideal position of placement for the ligature.

A suture is grasped with the special grasper and passed through the hole in the cone. This traverses the muscle, fascia and peritoneal layers. The suture is released inside the peritoneal cavity. To complete the stitch on the other side, the device is kept in place and turned through 180°. The grasper is reinserted and the intraperitoneal end of the suture is grasped and withdrawn from the peritoneal cavity as the cone is removed. The suture is tied extracorporeal under direct visual control.

Additional application is suture ligation of bleeding inferior epigastric vessels by using just the needle tipped grasper.

Closure cone

10 - 12 mm	8934.915
12 - 15 mm	8943.915
15 - 20 mm	8945.915

Needle-tipped grasper

with jaw to carry suture, Ø 2 mm, WL 160 mm, with rinsing port	8756.201
--	-----------------

Facial closure kit bundle	8756.205
--	-----------------

consisting of:

Facial closure tray (8585091M), needle forceps Ø 2.45 mm WL 160mm (8756.201),
sealing cone Ø 10-12 mm (8934.915), sealing cone Ø 12-15 mm (8943.915),
sealing cone Ø 15-20 mm (8945.915).

Injection/Aspiration
Cannulas 2 mm / 3 mm
with Luer connector

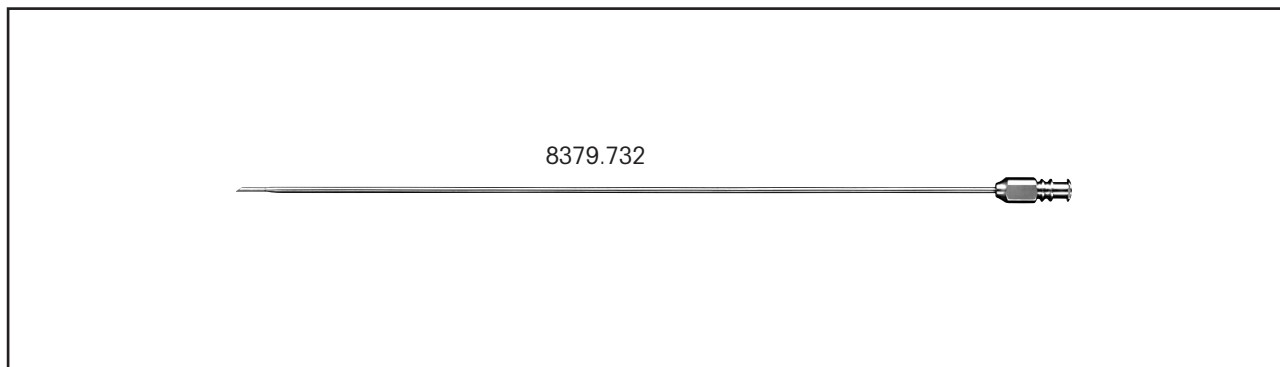

	Ø	WL 310 mm	Product No.
 Injection and aspiration cannula	3.0 mm	●	8379.732

Injection/Aspiration
Cannulas 5 mm
with Luer connector

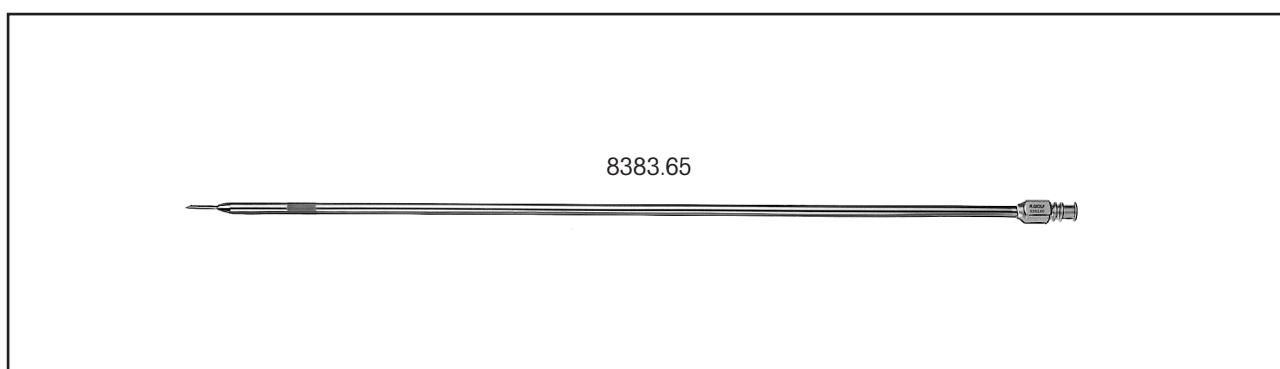

	Ø mm Tip	WL 345 mm	Product No.
 Injection cannula with 3 mm Luer connector	1.8 (15 G)	●	8383.65

Injection/Aspiration
Coagulation 5 mm
with suction control and Luer connector

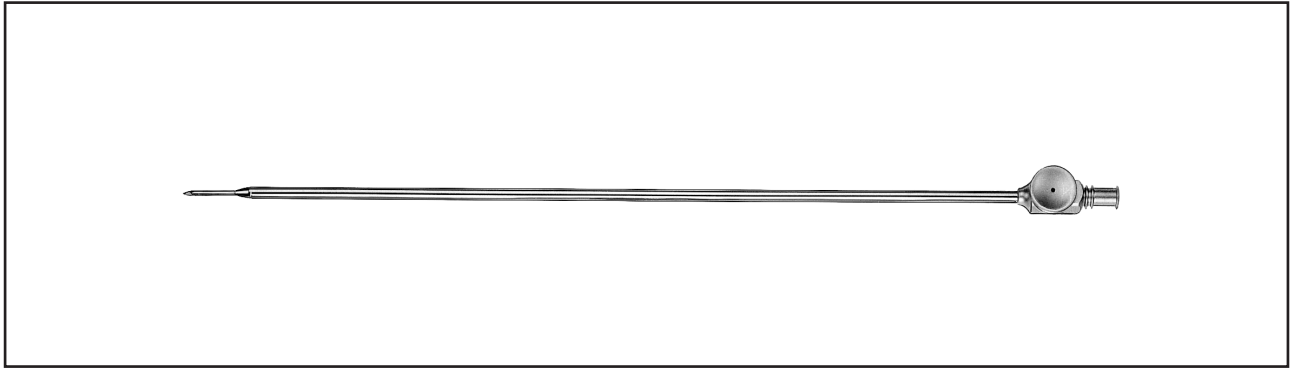

	WL 315 mm	Product No.
 Puncture cannula with suction control and 4 mm Luer connector	●	8383.49

LAPAROSCOPIC INSTRUMENTS

Probe 3.5 mm





	Ø mm Tip	WL 350 mm	Product No.
 Probe, graduated	3.5 mm	●	8379.672

LAPAROSCOPIC INSTRUMENTS

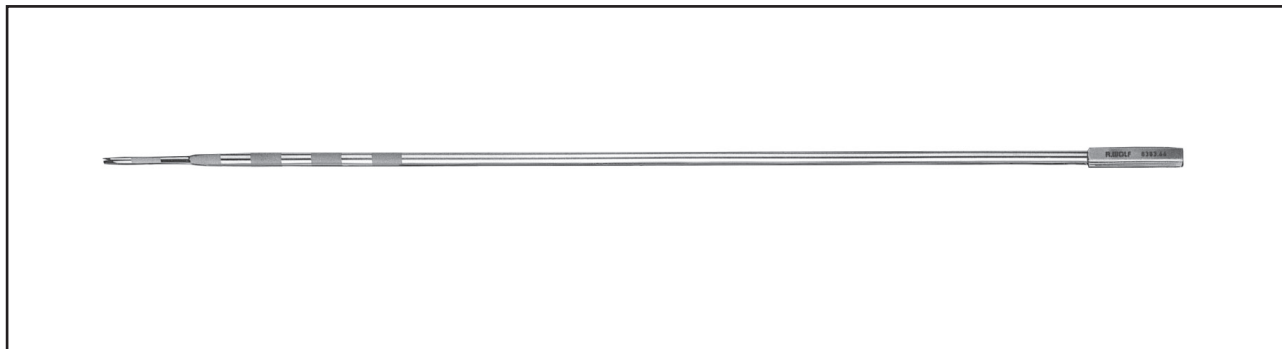
Probes/Manipulator 5 mm





	WL 320 mm	WL 445 mm	Product No.
	●		8383.661
Probe solid , with centimeter markings up to 5 cm		●	8384.661
		●	8384.66
Probe , graduated for palpation and measurement		●	8384.662
		●	8384.662
Probe solid* titanium (grey matte finish), with centimeter markings up to 5 cm		●	8384.662

* For use with lasers

ACCESSORIES

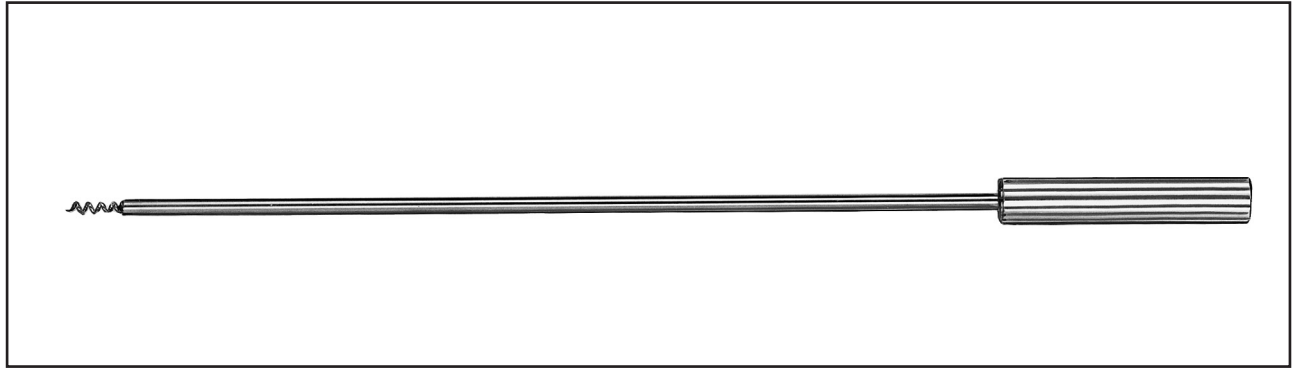
Myoma Screw 5 mm / 10 mm



	Ø	WL 340 mm	Product No.
 Myoma screw, rigid	5 mm	●	8383.611
	10 mm	●	8385.301

LAPAROSCOPIC INSTRUMENTS

Scope / Instrument Holder

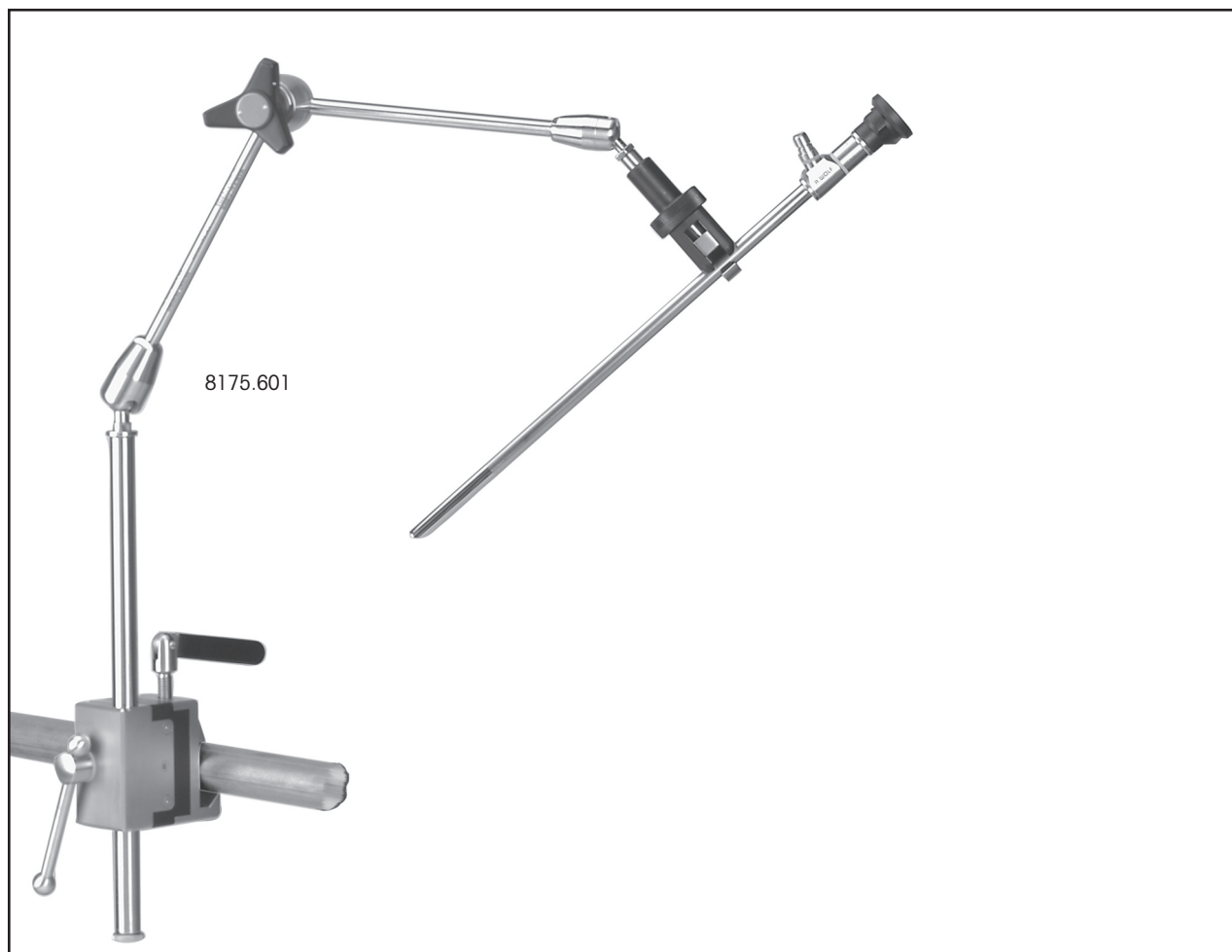







ACCESSORIES

Articulating scope / instrument holder,*

stabilizes laparoscopes, trocar sleeves and liver retractors to maintain their position**8175.601**









*for use with instruments and scopes from 5 mm - 12 mm in diameter

HF Monopolar Connecting Cables

Connector for instrument	Connector for unit	Length	Product No.
WOLF resectoscopes 	 ERBE (T series)	3 m	815.132
		3 m	815.033
	Monopolar HF electrodes 	Bovie / Valleylab / Erbe (Int.) / BOWA (Int.)	5 m
WOLF resectoscopes 			3 m
Monopolar HF electrodes 	 ERBE (T series)	3 m	8106.033
		5 m	8106.053

ACCESSORIES

HF Bipolar Connecting Cables

Connector for instrument	Connector for unit	Length	Product No.
 <p>WOLF bipolar forceps</p>	 ERBE (ACC / ICC / T) / BOWA (EU)	3 m	8108.032
	 Martin (Int.) / 2 pin Valleylab / BOWA (Int.)	3 m	8108.033
	 WOLF / Martin (m-Version) / Berchtold / Aesculap	5 m	8108.053
		3 m	8108.031
	 EMC Dolley	5 m	8108.051
		3 m	8108035
 <p>Bipolar tweezers</p>	 Martin (Int.) / 2 pin Valleylab / BOWA (Int.)	3 m	8108.133
	 WOLF / Martin (m-Version) / Berchtold / Aesculap	3 m	8108.131
	 EMC Dolley	3 m	8108135

ACCESSORIES