

General Surgery

1	<i>Laparoscopes</i>
2	<i>Insufflation</i>
3	<i>Trocars</i>
4	<i>Laparoscopic Instruments</i> <i>ERAGON</i>
5	<i>Accessories</i>
6	<i>TEM (Transanal Endoscopic Microsurgery)</i>

Richard Wolf Medical Instruments Corporation assumes no responsibility or liability for any errors or omissions in the content of this catalog. The information contained in this catalog is provided on an "as is" basis with no guarantees of completeness, accuracy, usefulness, or timeliness, and without warranties of any kind whatsoever, expressed or implied.

Mini Fiber Telescopes 2 mm

LAPAROSCOPES

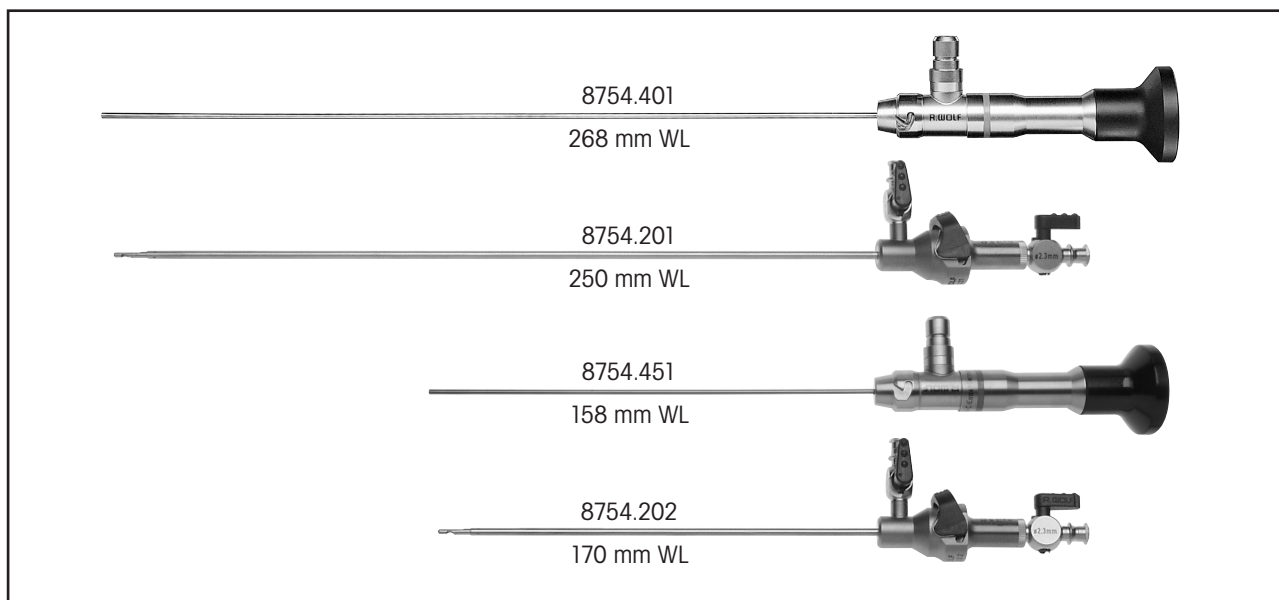

WL 268 mm standard version

Mini fiber telescope,

Ø 2 mm, 0° **8754.401**

Veres needle, Ø 2.3 mm (8754.211), with Ø 2.8 mm outer sheath (8754.221) **8754.201**

WL 158 mm standard version

Mini fiber telescope,

Ø 2 mm, 0° **8754.451**

Veres needle, Ø 2.3 mm (8754.212), with Ø 2.8 mm outer sheath (8754.222) **8754.202**

Recommended light cable:

Fiber light cable bundle, Ø 2.5 mm, 3 m long **806625301**

consisting of:

Fiber light cable (80662530), adapter projector side (8095.07) and adapter endoscope side (809509)

Accessories:

Scope protector (for telescope 8754.401 and 8754.451)

WL 320 mm, pack of 5..... **85709325**

Single scope tray (for telescope 8930.461 and 8930.462)..... **8570.017**

Laparoscopes 3.5 mm

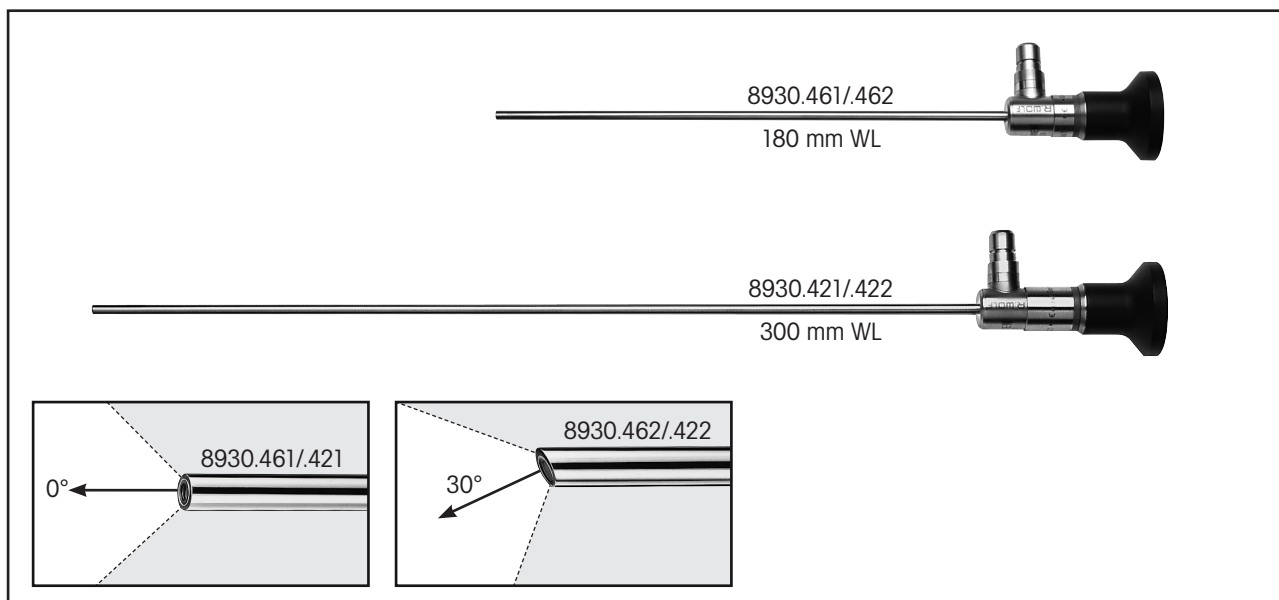

WL 180 mm

PANOVIEW PLUS telescope, Ø 3.5 mm,

0°	8930.461
30°	8930.462

WL 300 mm

PANOVIEW PLUS telescope, Ø 3.5 mm,

0°	8930.421
30°	8930.422

Recommended light cable:

Fiber light cable bundle, Ø 2.5 mm, 3 m long **806625301**

consisting of:

Fiber light cable (80662530), adapter projector side (8095.07) and adapter endoscope side (809509)

Accessories:

Scope protector (for telescope 8930.461 and 8930.462)

WL 200 mm, pack of 5 **8570.9205**

Scope protector (for telescope 8930.421 and 8930.422)

WL 320 mm, pack of 5..... **8570.9325**

Single scope tray (for telescope 8930.461 and 8930.462)..... **8570.017**

Laparoscopes 5.3 mm distortion-free

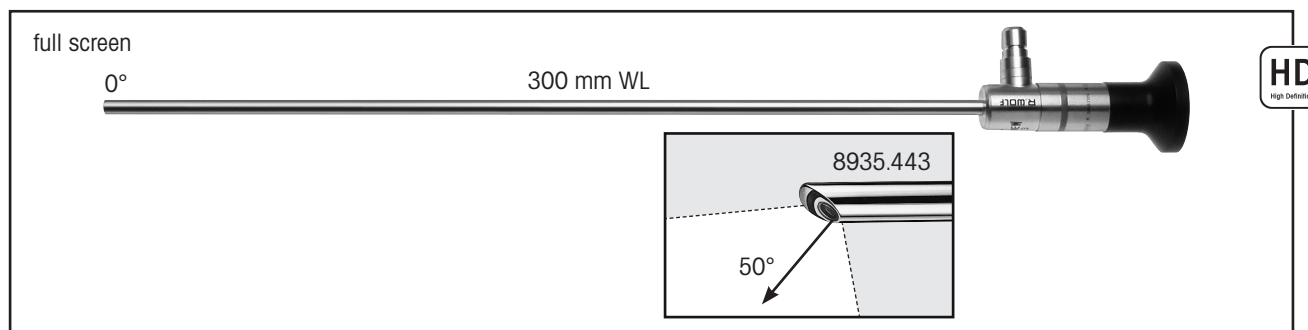

PANOVIEW telescope, Ø 5.3 mm, distortion-free, full screen

50° **8935.443**

Recommended light cable:

Fiber light cable bundle, Ø 3.5 mm, 3 m long **806635301**

consisting of:

Fiber light cable (80663530), adapter projector side (8095.07) and adapter endoscope side (809509)

Accessories:

Scope protector (for telescope 8935.443)

WL 320 mm, pack of 5..... **8570.9325**

Single scope tray (for telescope 8935.443)..... **8570.017**

Mini-Operating-Laparoscope 5.5 mm with 3.5 mm Working Channel

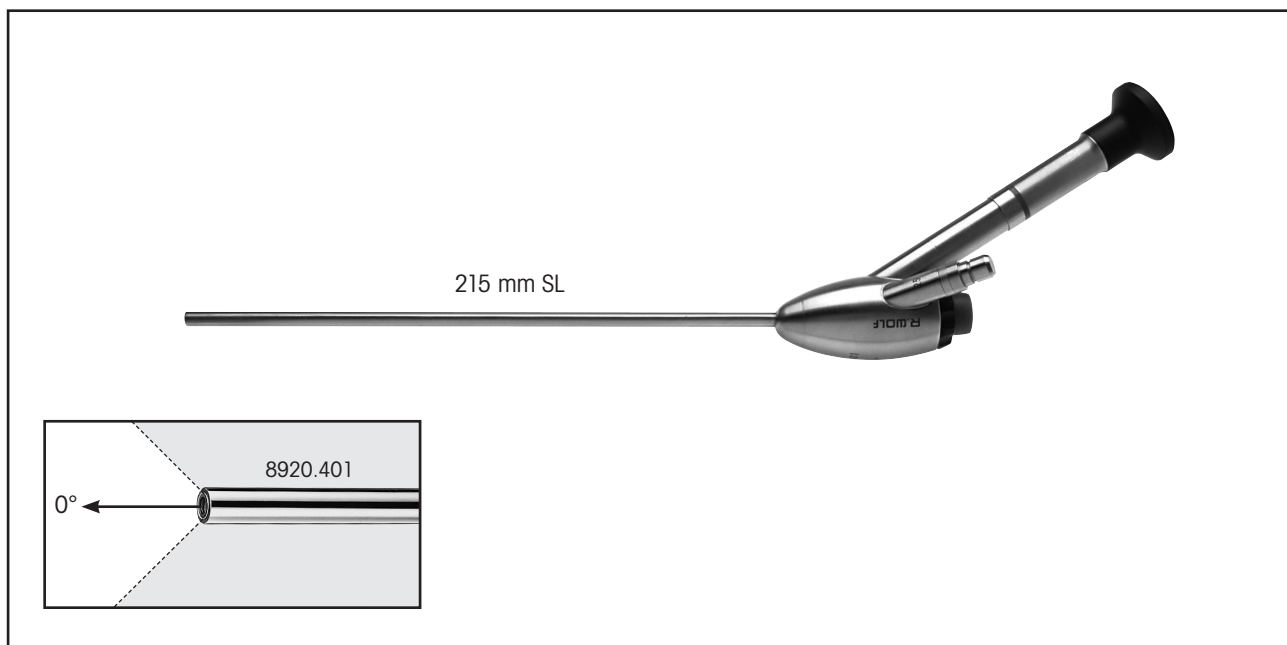

OP Endoscope bundle, Ø 5.5 mm, SL 215 mm89204015

consisting of:

OP endoscope with 3.5 mm working channel (8920.401), sealing element (8920.311), sealing cap (89.01), sealing membrane (89.103)

Spare membrane valves, yellow, pack of 1089.103

Recommended light cable:

Fiber light cable bundle Ø 2.5 mm, 3 m long806625301

consisting of:

Fiber light cable (80662530), adapter projector side (8095.07) and adapter endoscope side (809509)

The trocar sleeves 8919.333 / .353 with optimized working length are recommended.

Telescopes 5.5 mm optimized for 4K UHD

LAPAROSCOPES

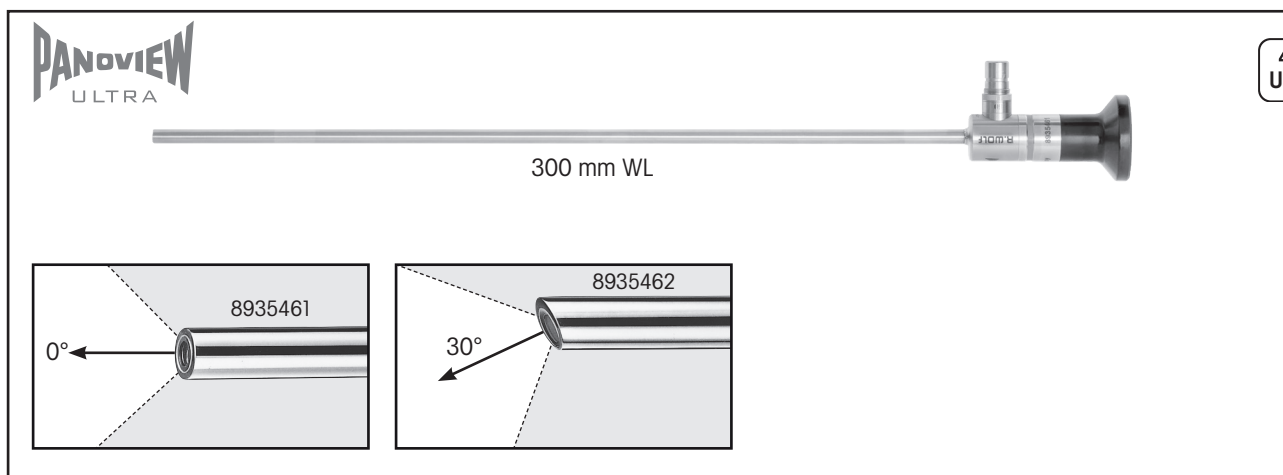

PANOVIEW ULTRA telescope, Ø 5.5 mm,

distortion-free, full screen

0° **8935461**

30° **8935462**

Recommended light cable:

Fusion fiber light cable bundle, Ø 5.0 mm, 3 m long **806550301**

consisting of:

Fiber light cable (80655030), adapter projector side (8095.07) and adapter endoscope side (809509)

Accessories:

Single scope tray **8570.017**

Telescopes 5.5 mm
optimized for 4K UHD
bariatric length

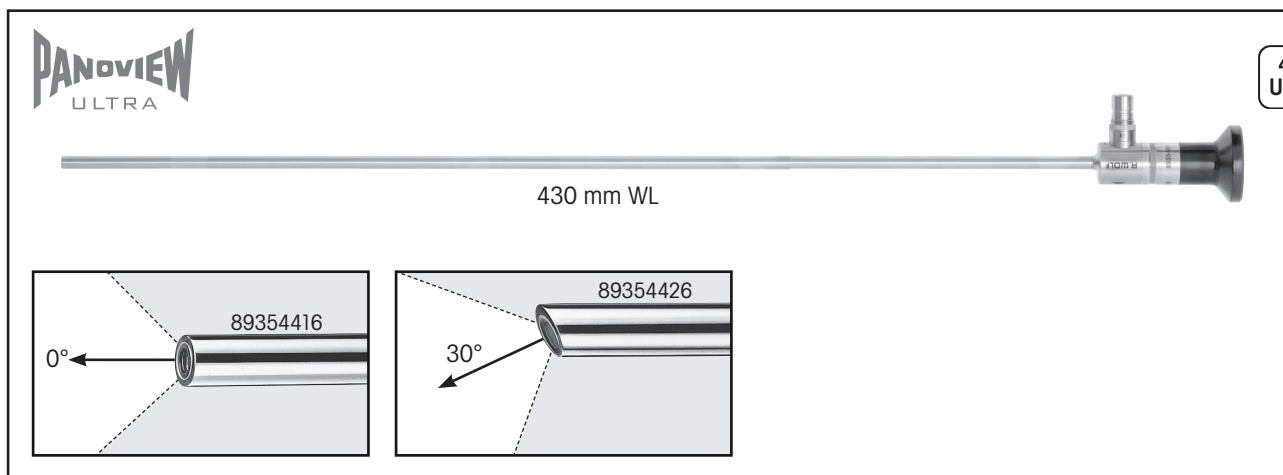

PANOVIEW ULTRA telescope, Ø 5.5 mm,

distortion-free, full screen

0° **89354416**

30° **89354426**

Recommended light cable:

Fusion fiber light cable bundle, Ø 5.0 mm, 3 m long **806550301**

consisting of:

Fiber light cable (80655030), adapter projector side (8095.07) and adapter endoscope side (809509)

Accessories:

Single scope tray **8570.019**

Laparoscopes 10 mm distortion-free

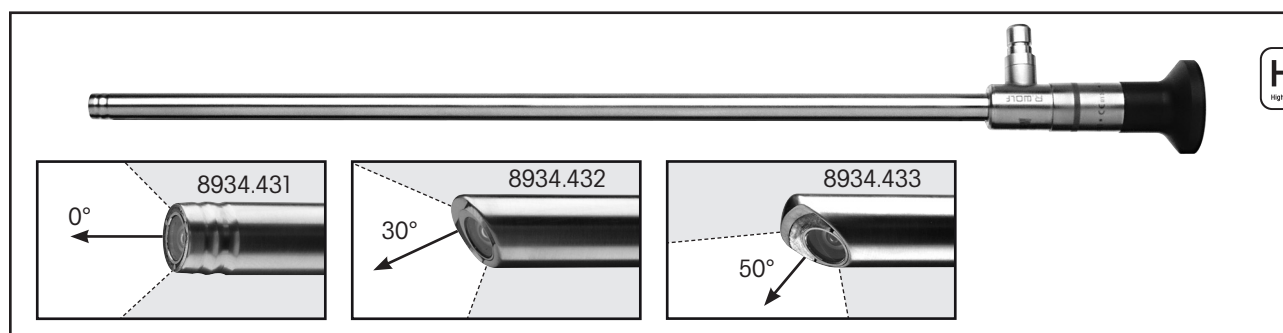

PANOVIEW telescope, Ø 10 mm, distortion-free

0°, 307 mm WL	8934.431
30°, 307 mm WL	8934.432
50°, 310 mm WL	8934.433

Recommended light cable:

Fusion fiber light cable bundle, Ø 5.0 mm, 3 m long **806550301**

consisting of:

Fiber light cable (80655030), adapter projector side (8095.07) and adapter endoscope side (809509)

Accessories:

Single scope tray **8570.017**

Double scope tray **8570.010**

Laparoscopes 10 mm bariatric length

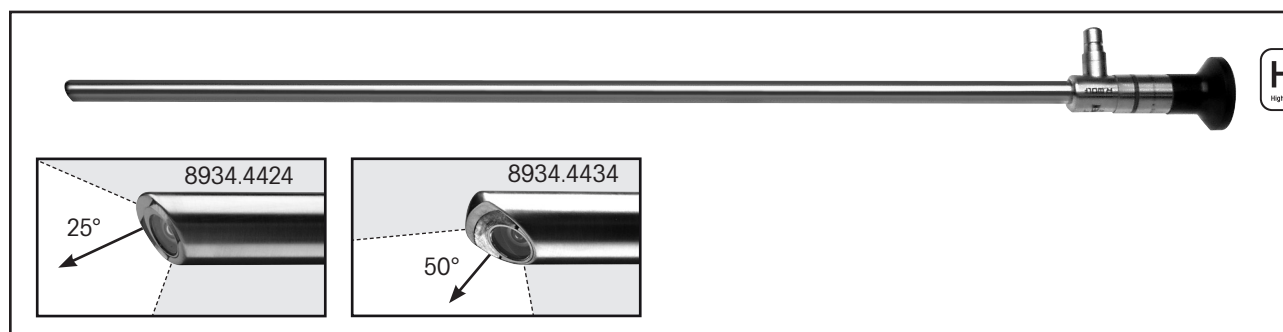

PANOVIEW telescope, Ø 10 mm

25°, 438 mm WL	8934.4424
50°, 447 mm WL	8934.4434

Recommended light cable:

Fusion fiber light cable bundle, Ø 5.0 mm, 3 m long **806550301**

consisting of:

Fiber light cable (80655030), adapter projector side (8095.07) and adapter endoscope side (809509)

Accessories:

Single scope tray **8570.019**

Telescopes 10 mm

Optimized for 4K UHD and NIR/ICG applications

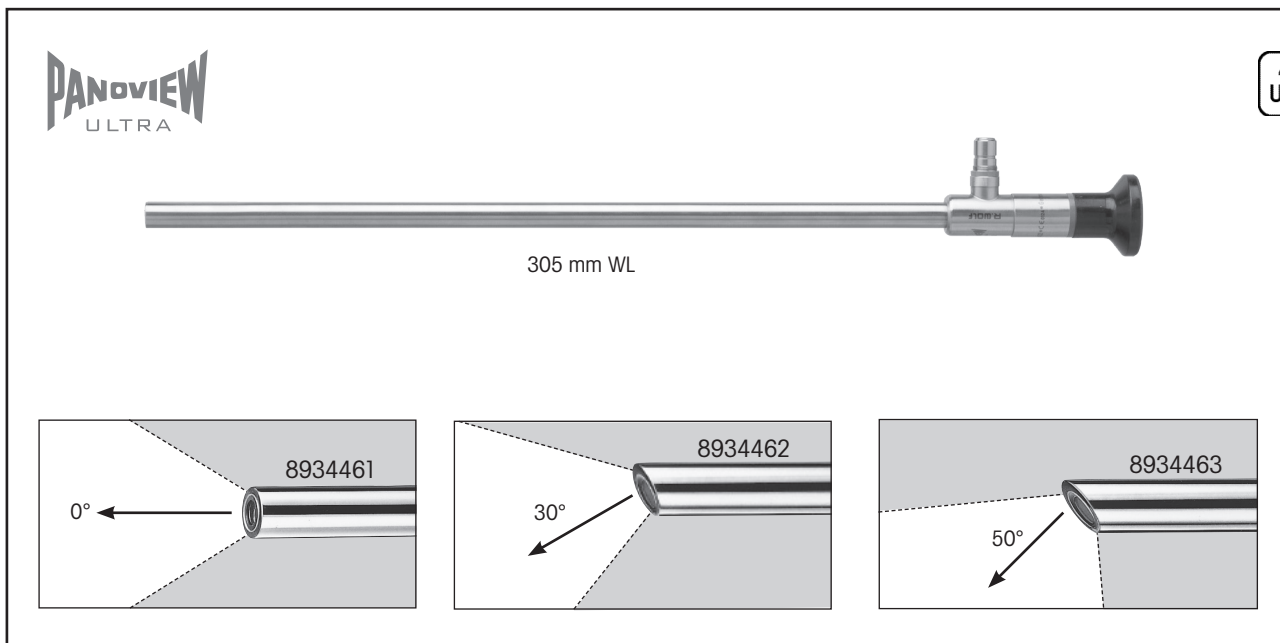

PANOVIEW ULTRA telescope, Ø 10 mm, 305 mm WL

0°	8934461
30°	8934462
50°	8934463

Fusion fiber light cable bundle, Ø 5.0 mm, 3.0 m long.....806550301

consisting of:

Fusion fiber light cable (80655030), adapter projector side (8095.07) and adapter endoscope side (809509)

Accessories:

Single scope tray.....8570.017

Double scope tray.....8570.010

Note: Compatible with System green (NIR/ICG capable)

Telescopes 10 mm

Optimized for 4K UHD and NIR/ICG applications

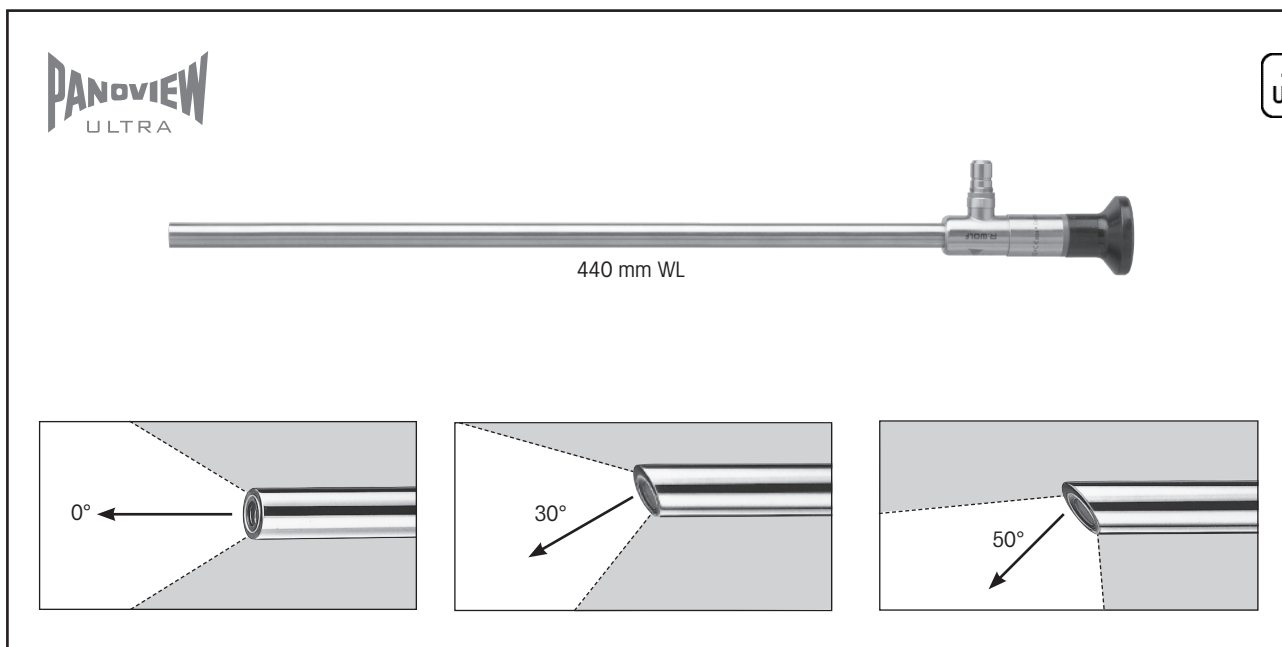

PANOVIEW ULTRA telescope, Ø 10 mm, 440 mm WL

0°	89344416
30°	89344426
50°	89344436

Fusion fiber light cable bundle, Ø 5.0 mm, 3 m long.....806550301

consisting of:

Fusion fiber light cable (80655030), adapter projector side (8095.07) and adapter endoscope side (809509)

Accessories:

Single scope tray.....8570.019

Note: Compatible with System green (NIR/ICG capable)

INSUFFLATOR Highflow 45 BASIC



INSUFFLATION

- 6.5" color display
- Touchscreen
- Max. flow rate 45 l / min
- Functional and user-friendly design

INSUFFLATOR Highflow 45 BASIC bundle **223560155**

consisting of:

INSUFFLATOR Highflow 45 Basic (2235601), power cord (N710171), CO₂ pressure tube (74021.029), CO₂ pressure reducer (74007.055) and hose assembly (RWM-284)

Accessories:

- CO₂ Pressure reducer** DIN EN ISO 407 **74007.055**
- Insufflation tube**, disposable with integrated hygiene filter, pack of 10, in individual sterile packs **4170.501**
- Hygiene filter**, sterile pack of 10 **4171.111**
- Hose assembly**, for CO₂ wall source **RWM-284**

INSUFFLATOR

Highflow 45 BASIC

Technical data

Protection class complying with IEC / EN 60601-1; (UL 60601-1 / CSA C22.2 No.601.1 - for USA)	1
Electromagnetic compatibility (EMC)	according to EN 60601-1-2
Medical Device Directive 93/42/EEC	Class IIb
Protection against electric shock	Application part of Type CF
Degree of protection against penetration of liquids	IP 20 (not protected)
Duty cycle	Continuous operation
Degree of protection when flammable mixtures are present	This device is not protected against explosions (Do not operate this device in areas where explosive substances are present)
Weight	8.9 kg (19.5 lbs)
Dimensions (W x H x D)	300 mm x 160 mm x 455 mm
Voltage	100 - 240 V~ / a.c.
Frequency	50 / 60 Hz
Power consumption	60 VA
Fuse	T 3.15 H
Power rating	0.6 - 0.2 A

Relevant application parameters:

Insufflation medium	med. CO ₂ (purity > 99.5 %)
Intra-abdominal pressure	3 mmHg to 25 mmHg, (± 2 mmHg) preselectable in 1 mmHg steps
Gas flow rate: - primary filling - high flow	1 l/min. 2 l/min. to 45 l/min. (± 20 %) preselectable in 1 l/min steps
Consumption display	0 l to 9999 l (± 20 %)

INSUFFLATOR Highflow 45 EVAC



INSUFFLATION

- 6.5" color display
- Touchscreen
- Max. flow rate 45 l / min
- Functional and user-friendly design
- Smoke evacuation

INSUFFLATOR Highflow 45 EVAC bundle **223561155**

consisting of:

INSUFFLATOR Highflow 45 EVAC (2235611), power cable (N710171), CO₂ pressure tube (74021.029), CO₂ pressure reducer (74007.055) and hose assembly (RWM-284)

Accessories:

CO₂ Pressure reducer DIN EN ISO 407 **74007.055**

Disposable tube set for smoke evacuation, sterile, pack of 10 **4170503**

Insufflation tube, disposable with integrated hygiene filter, pack of 10, in individual sterile packs **4170.501**

Hygiene filter, sterile pack of 10 **4171.111**

Hose assembly, for CO₂ wall source **RWM-284**

Smoke evacuation foot pedal **20301031**

INSUFFLATOR

Highflow 45 EVAC

Technical data

Protection class complying with IEC / EN 60601-1; (UL 60601-1 / CSA C22.2 No.601.1 - for USA)	1
Electromagnetic compatibility (EMC)	according to EN 60601-1-2
Medical Device Directive 93/42/EEC	Class IIb
Protection against electric shock	Application part of Type CF
Degree of protection against penetration of liquids	IP 20 (not protected)
Duty cycle	Continuous operation
Degree of protection when flammable mixtures are present	This device is not protected against explosions (Do not operate this device in areas where explosive substances are present)
Weight	8.9 kg (19.5 lbs)
Dimensions (W x H x D)	300 mm x 160 mm x 455 mm
Voltage	100 - 240 V~ / a.c.
Frequency	50 / 60 Hz
Power consumption	60 VA
Fuse	T 3.15 H
Power rating	0.6 - 0.2 A

Relevant application parameters:

Insufflation medium	med. CO ₂ (purity > 99.5 %)
Intra-abdominal pressure	3 mmHg to 25 mmHg, (± 2 mmHg) preselectable in 1 mmHg steps
Gas flow rate: - primary filling - high flow	1 l/min. 2 l/min. to 45 l/min. (± 20 %) preselectable in 1 l/min steps
Consumption display	0 l to 9999 l (± 20 %)

Passive Smoke-Evacuation Filter for smoke discharge

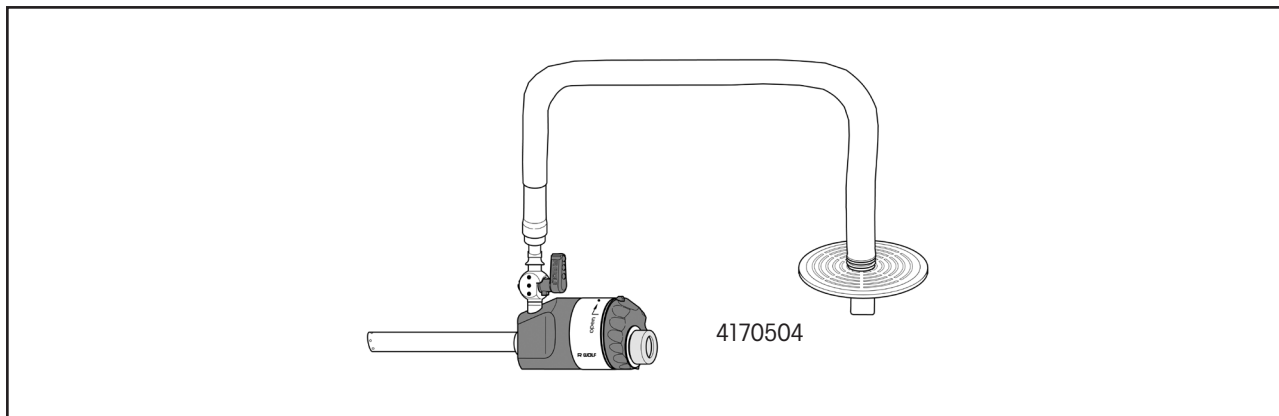

Passive smoke-evacuation filter*, sterile, pack of 10..... **4170504**

* For direct connection to trocar, as an alternative to active smoke evacuation

TROCARS

Veres Cannulas for establishing the pneumoperitoneum

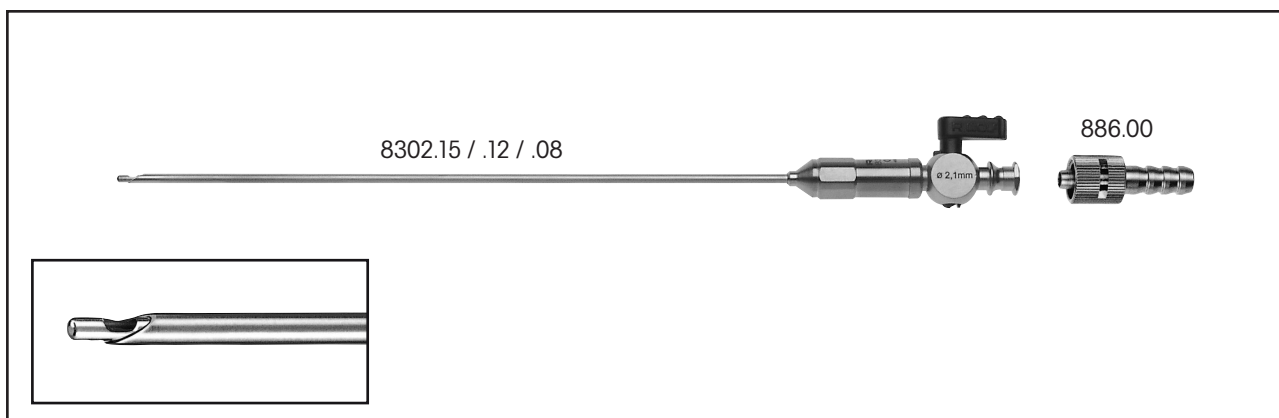



Veres cannulas



150 mm working length	8302.15
120 mm working length (standard length)	8302.12
80 mm working length	8302.08

Accessories:

Luer connector	886.00
-----------------------------	---------------

Trocar Sleeves 2 mm

Trocar sleeve with insufflation connector				Trocar, pyramidal tip	
					
	WL	Capacity	Types		
Metal sleeve, standard, straight distal tip		100 mm	2 mm	8309.014	8309.123





Trocar sleeve				Trocar, pyramidal tip	
					
	WL	Capacity	Types		
Plastic sleeve with retaining thread, straight distal tip		60 mm	2 mm	8309.072	8309.121

Accessories:

Spare sealing caps, pack of 10 **88.01**

TROCARS

Trocar Sleeves 3.5 mm









RWO-ART trocar sleeves with magnetic-ball-valve with insufflation tap					
					
	WL	Capacity	Types		
Metal sleeve, standard, straight distal tip 	100 mm	3.5 mm	8903.014	8903.103	8903.123
Plastic sleeve, retaining thread, straight distal tip 	60 mm	3.5 mm	8903.072	8903.101	8903.121
	100 mm	3.5 mm	8903.034	8903.103	8903.123

Accessories:

Spare ball , 1 piece, capacity Ø 3.5 mm - 5.5 mm	8921.901
Spare o-rings , pack of 10, capacity Ø 3.5 mm - 5.5 mm	8921.951
Spare sealing caps , pack of 10, capacity 3.5 mm, red	89.01
Spare stopcocks , pack of 5	896.0002

TROCARS

Trocar Sleeves 5.5 mm







RWO-ART trocar sleeves with magnetic-ball-valve with insufflation tap				Trocar, blunt conical tip	Trocar, conical tip	Trocar, pyramidal tip
						
	WL	Capacity	Types			
Metal sleeve, standard, straight distal tip 	100 mm	5.5 mm	8921.014	8921.103	8921.113	8921.123
	150 mm	5.5 mm	8921.016	8921.105	8921.115	8921.125
Metal sleeve, standard, oblique distal tip 	100 mm	5.5 mm	8921.013	8921.103	8921.113	8921.123
Metal sleeve, retaining thread, straight distal tip 	100 mm	5.5 mm	8921.024	8921.103	8921.113	8921.123
	150 mm	5.5 mm	8921.026	8921.105	8921.115	8921.125
Metal sleeve, retaining thread, oblique distal tip 	100 mm	5.5 mm	8921.023	8921.103	8921.113	8921.123
Plastic sleeve, retaining thread, straight distal tip 	100 mm	5.5 mm	8921.034	8921.103	8921.113	8921.123

TROCARS

Accessories:

- Spare ball**, 1 piece, capacity Ø 3.5 mm - 5.5 mm **8921.901**
- Spare o-rings**, pack of 10, capacity Ø 3.5 mm - 5.5 mm **8921.951**
- Spare sealing caps**, pack of 10, capacity 5.5 mm, blue **89.02**
- Spare stopcocks**, pack of 5 **896.0002**

Trocar Sleeves 5.5 mm



RWO-ART trocar sleeves with magnetic-ball-valve					Trocar, blunt conical tip	Trocar, conical tip	Trocar, pyramidal tip
							
		WL	Capacity	Types			
Metal sleeve, standard, straight distal tip		60 mm	5.5 mm	8921.052	8921.101	8921.111	8921.121
Metal sleeve, standard, oblique distal tip		60 mm	5.5 mm	8921.051	8921.101	8921.111	8921.121
Metal sleeve, retaining thread, straight distal tip		60 mm	5.5 mm	8921.062	8921.101	8921.111	8921.121

Accessories:

- Spare ball**, 1 piece, capacity Ø 3.5 mm - 5.5 mm **8921.901**
- Spare o-rings**, pack of 10, capacity Ø 3.5 mm - 5.5 mm **8921.951**
- Spare sealing caps**, pack of 10, capacity 5.5 mm, blue **89.02**

TROCARS

Flexible Trocar Sleeves 5.5 mm for curved instruments





				Trocar, pyramidal tip	Trocar, ball shaped
					
	WL	Capacity	Types		
Plastic sheath with retaining thread, straight distal tip, incl. membrane valves 89.103 (pack of 10)	62 mm	5.8 mm	8905.331		8905.3315
	102 mm	5.8 mm	8905.351	8905.3513	8905.3515

TROCARS

Accessories:

Membrane valves, yellow, pack of 10 **89.103**

Trocar Sleeves 5.5 mm plastic with membrane seal



					Trocar, blunt conical tip	Trocar, conical tip	Trocar, pyramidal tip
							
	WL	Capacity	with stopcock	Types			
Plastic sheath with retaining thread, straight distal tip, incl. membrane valves 89.103 (pack of 10)	65 mm	5.5 mm	●	8919.333	8919.3311	8919.3312	8919.3313
		5.5 mm		8919.331			
	105 mm	5.5 mm	●	8919.353	8919.3511	8919.3512	8919.3513
		5.5 mm		8919.351			

Accessories:



Membrane valves, yellow, pack of 10 **89.103**



Spare stopcocks, pack of 5 **896.0002**

Trocar Sleeve 5.5 mm



Flexible trocar sleeve, plastic				Trocar, blunt conical tip	
					
	WL	Capacity	Types		
Oblique distal tip	 75 mm	5.5 mm	8906.051	8906.151	

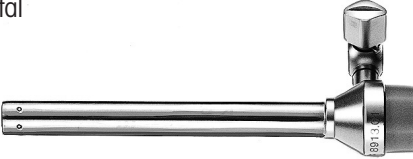

Trocar Sleeves 7 mm



Flexible trocar sleeve, plastic				Trocar, blunt conical tip	
					
	WL	Capacity	Types		
Straight distal tip	 75 mm	7 mm	8906.001	8913.11	

Trocar sleeve with lateral tap, metal				Trocar, blunt conical tip	
					
	WL	Capacity	Types		
Straight distal tip	 75 mm	7 mm	8913.01	8913.11	





Trocar Sleeves 10 mm-18 mm

Flexible trocar sleeve, plastic						Trocar, blunt conical tip			
		WL	Capacity	Types					
Straight distal tip			60 mm	10 mm	8906.011	8906.111			

Flexible trocar sleeve, plastic						Trocar, blunt conical tip			
		WL	Capacity	Types					
Straight distal tip			60 mm	12.5 mm	8906.031	8906.131			

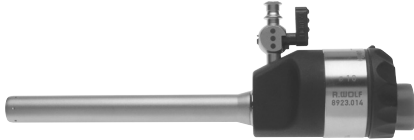
Trocar sleeve, metal, oval						Trocar, blunt conical tip			
		WL	Capacity	Types					
Straight distal tip			55 mm	13.6 / 18 mm	8906.081	8906.181			

Trocar Sleeves 10 mm with insufflation tap

RWO-ART trocar sleeves with magnetic-ball-valve					Trocar, blunt conical tip	Trocar, conical tip	Trocar, pyramidal tip
							
	WL	Capacity	Types				
Metal sleeve, standard, straight distal tip	100 mm	10 mm	8923.014	8923.103	8923.113	8923.123	
	150 mm	10 mm	8923.016	-	8923.115	8923.125	
Metal sleeve, standard, oblique distal tip	100 mm	10 mm	8923.013	8923.103	8923.113	8923.123	
Metal sleeve, retaining thread, straight distal tip	100 mm	10 mm	8923.024	8923.103	8923.113	8923.123	
	150 mm	10 mm	8923.026	-	8923.115	8923.125	
Metal sleeve, retaining thread, oblique distal tip	100 mm	10 mm	8923.023	8923.103	8923.113	8923.123	





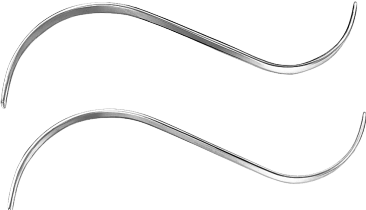

TROCARS

Accessories:

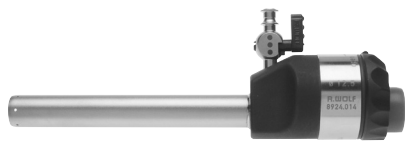
- Spare ball**, 1 piece, capacity Ø 7 mm - 12.5 mm **8923.901**
- Spare o-rings**, pack of 10, capacity Ø 7 mm - 12.5 mm **8923.951**
- Spare sealing caps**, pack of 10, capacity 10 mm, red **89.08**
- Spare stopcocks**, pack of 5 **896.0002**

	To expose anatomical layers: Tissue retractors , S-shaped, set of two	8928.90
---	--	----------------

Trocar Sleeves 12.5 mm with insufflation tap

RWO-ART trocar sleeves with magnetic-ball-valve					Trocar, blunt conical tip	Trocar, conical tip	Trocar, pyramidal tip
							
		WL	Capacity	Types			
Metal sleeve, standard, straight distal tip		100 mm	12.5 mm	8924.014	8924.103	8924.113	8924.123
		150 mm	12.5 mm	8924.016	-	8924.115	8924.125
Metal sleeve, standard, oblique distal tip		100 mm	12.5 mm	8924.013	8924.103	8924.113	8924.123
Metal sleeve, retaining thread, straight distal tip		150 mm	12.5 mm	8924.026	-	8924.115	8924.125

TROCARS

Accessories:

VARIO-PORT reducing adapter

for reduction from:

Ø 10 mm to Ø 5.5 mm and

Ø 12.5 mm to Ø 5.5 mm, pack of 5 **8923.802**



Dilatation and Extraction Instruments

3.5 mm to 5.5 mm / 5.5 mm to 10 mm

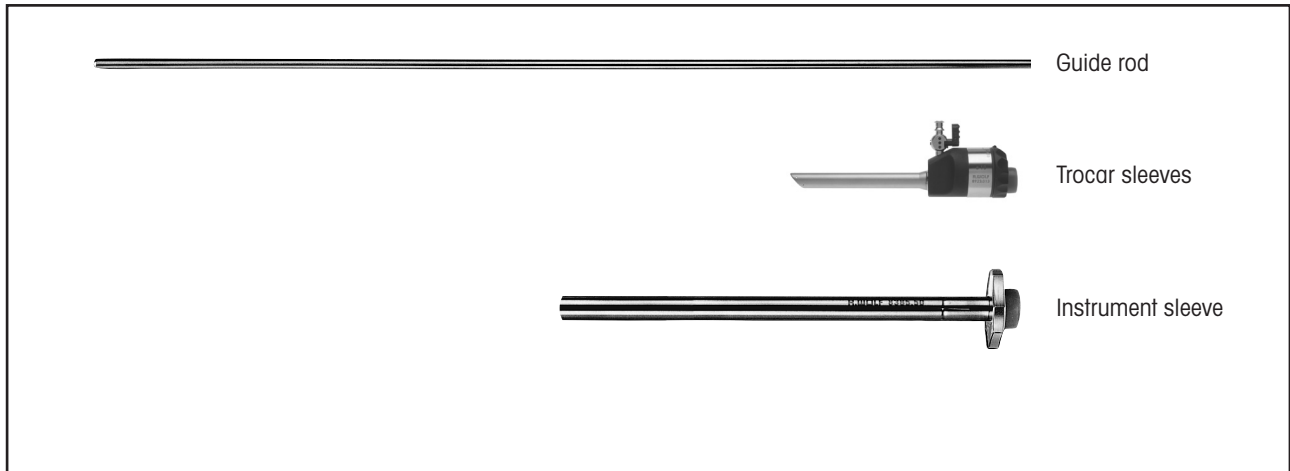

To extend an incision	Guide rod	Trocar sleeve	Instrument sleeve, extractor and reducing sleeve
3.5 mm to 5.5 mm	-	8921.013	8383.78*
5.5 mm to 10 mm	8934.951	8923.013 (5.5 mm to 10 mm)	-

* For sealed application of 3.5 mm instruments in the 5.5 mm trocar sleeve

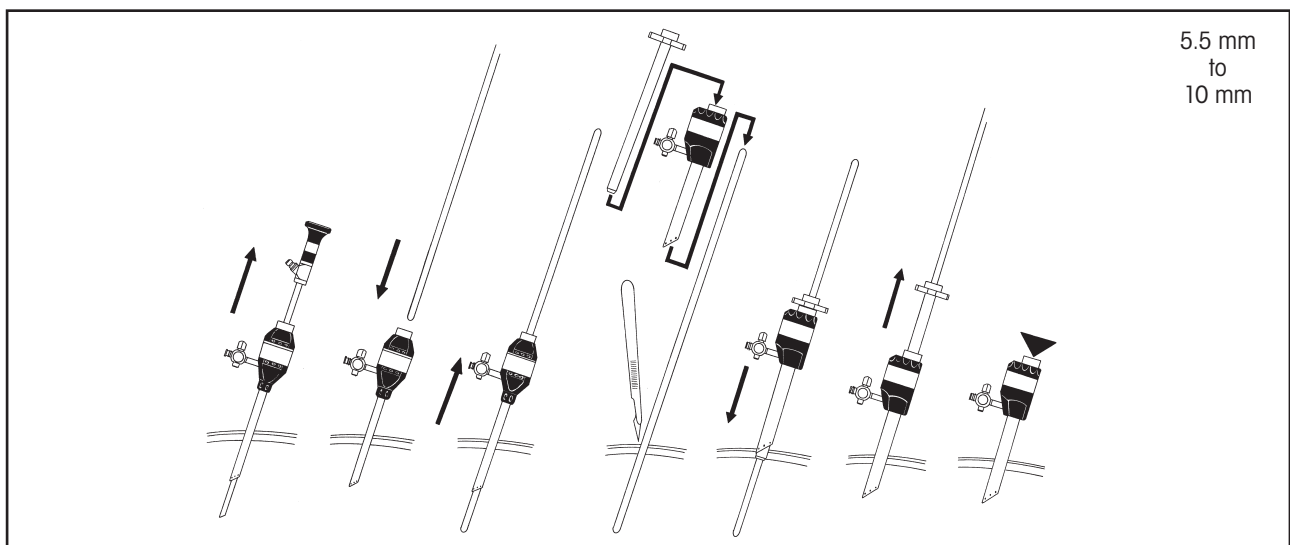

TROCARS

Reducing Sleeve

for RIWO-ART trocar sleeves

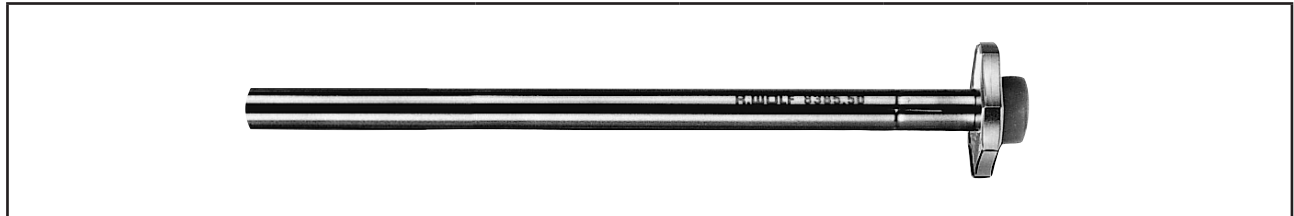

	Outer Ø	WL	for instrument sizes	Types
5.5/3.5 mm Reducing sleeve*	5.5 mm	160 mm	3.5 mm	8383.78







Accessories:







***Spare sealing caps, pack of 10..... 89.02**

TROCARS

ERAGON modular
mini

modular instruments 3.5 mm, insulated

	Handle type				Knob attachment, ERAGONaxial 	
	 with locking mechanism, rotatable	 without locking mechanism, rotatable	 with locking mechanism, rotatable	 with locking mechanism, non rotatable		
All jaw inserts and sheaths can also be combined with ERAGONaxial.	Product No.	83930082	83930083	83930084	83930085	8988

Jaw insert 	Sheath tube, insulated 		Handle type HF / mono  with locking mechanism, rotatable	Complete instrument <ul style="list-style-type: none"> • Jaw Insert • Sheath • Handle
	WL 240 mm	WL 330 mm		
Product No.	8390933	8391933	83930074	Bundle No.
 Grasping and dissecting forceps long, fine tip, double jaw action, JL= 18 mm	●	●	●	8390221 8391221
 Grasping and dissecting forceps short, fine tip, double jaw action, JL= 14 mm	●	●	●	8390222 8391222
 Grasping and dissecting forceps curved right, double jaw action, JL= 14 mm	●	●	●	8390223 8391223





* JL = Jaw length when jaws closed (approximate measurements)





HF connecting cable see page 87.

ERAGON

ERAGON modular
mini

modular instruments 3.5 mm, insulated

ERAGON axial	Handle type				Knob attachment, ERAGONaxial
		HF / mono 	HF / mono 		
All jaw inserts and sheaths can also be combined with ERAGONaxial.	with locking mechanism, rotatable	without locking mechanism, rotatable	with locking mechanism, rotatable	with locking mechanism, non rotatable	
Product No.	83930082	83930083	83930084	83930085	8988

Jaw insert	Sheath tube, insulated		Handle type HF / mono	Complete instrument • Jaw Insert • Sheath • Handle	
	WL 240 mm	WL 330 mm	 with locking mechanism, rotatable		
	Product No.	8390933	8391933	83930074	Bundle No.
 Grasping and dissecting forceps, long, fine tip, double jaw action, JL= 15mm	8390207	●		●	83902077
	8391207		●	●	83912077
 Double-spoon forceps, by Hürtgen, double jaw action, JL= 12 mm	8390216	●		●	83902167
	8391216		●	●	83912167
 Punch by Friedel, single jaw action, JL= 10 mm	8390217	●		●	83902177
	8391217		●	●	83912177



* JL = Jaw length when jaws closed (approximate measurements)







HF connecting cable see page 87.

ERAGON

ERAGON modular
mini

modular scissors 3.5 mm, insulated

 All jaw inserts and sheaths can also be combined with ERAGONaxial.	Handle type HF / mono  without locking mechanism, rotatable		Knob attachment, ERAGONaxial 
	Product No.	83930083	8988

Jaw insert 	Sheath tube, insulated 		Handle type HF / mono  without locking mechanism, rotatable	Complete instrument • Jaw Insert • Sheath • Handle
	WL 240 mm	WL 330 mm		
 Scissors "Metzenbaum" , double jaw action, JL= 16 mm	●		●	83902157
8390215				83902157
 Scissors "Metzenbaum" , fine serrated, curved, double jaw action, JL= 14 mm	●		●	83902247
8390224			●	83912247
 Hook scissors , single jaw action, JL= 8 mm	●		●	83902277
8390227			●	83912277





* JL = Jaw length when jaws closed (approximate measurements)







HF connecting cable see page 87.

ERAGON

ERAGON modular
mini

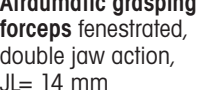
modular instruments 3.5 mm, non-insulated

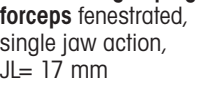

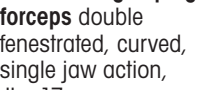

 All jaw inserts and sheaths can also be combined with ERAGONaxial.	Handle type		Knob attachment, ERAGONaxial 
	 with locking mechanism, rotatable	 with locking mechanism, non rotatable	
Product No.	83930082	83930085	8988







Jaw insert 	Sheath tube, non-insulated		Handle type  with locking mechanism, rotatable	Complete instrument • Jaw Insert • Sheath • Handle
	WL 240 mm	WL 330 mm		
Product No.	8390934	8391934	83930072	Bundle No.
 Atraumatic grasping forceps fenestrated, double jaw action, JL= 14 mm	●		●	83902087
 Atraumatic grasping forceps fenestrated, single jaw action, JL= 14 mm		●	●	83912087
 Atraumatic grasping forceps fenestrated, single jaw action, JL= 17 mm	●		●	83902187
 Atraumatic grasping forceps fenestrated, single jaw action, JL= 17 mm		●	●	83912187
 Atraumatic grasping forceps double fenestrated, curved, single jaw action, JL= 17 mm	●		●	83902257
 Atraumatic grasping forceps double fenestrated, curved, single jaw action, JL= 17 mm		●	●	83912257

* JL = Jaw length when jaws closed (approximate measurements)

ERAGON modular
mini

modular instruments 3.5 mm, non-insulated

 All jaw inserts and sheaths can also be combined with ERAGONaxial.	Handle type		Knob attachment, ERAGONaxial 
	 with locking mechanism, rotatable	 with locking mechanism, non rotatable	
Product No.	83930082	83930085	8988





Jaw insert 	Sheath tube, non-insulated 		Handle type  with locking mechanism, rotatable	Complete instrument • Jaw Insert • Sheath • Handle
	WL 240 mm	WL 330 mm		
Product No.	8390934	8391934	83930072	Bundle No.
 Atraumatic grasping forceps fenestrated, double jaw action, JL= 19 mm	●		●	83902267
		●	●	83912267
 Grasping and dissecting forceps , double jaw action, JL= 13 mm	●		●	83902197
		●	●	83912197
 Grasping and dissecting forceps 2x4 teeth, double jaw action, JL= 14 mm	●		●	83902207
		●	●	83912207





* JL = Jaw length when jaws closed (approximate measurements)

ERAGON

ERAGON modular
mini

modular instruments 3.5 mm, non-insulated

 All jaw inserts and sheaths can also be combined with ERAGONaxial.	Handle type		Knob attachment, ERAGONaxial 
	 with locking mechanism, rotatable	 with locking mechanism, non rotatable	
Product No.	83930082	83930085	8988





Jaw insert 	Sheath tube, non-insulated		Handle type  with locking mechanism, rotatable	Complete instrument • Jaw Insert • Sheath • Handle
	WL 240 mm	WL 330 mm		
Product No.	8390934	8391934	83930072	Bundle No.
 Universal grasping forceps, double jaw action, JL= 14 mm	●		●	83902097
		●	●	83912097
 Grasping forceps "Babcock", double jaw action, JL= 19 mm	●		●	83902107
		●	●	83912107







* JL = Jaw length when jaws closed (approximate measurements)

ERAGON

ERAGON modular

modular instruments 5 mm, insulated

ERAGON axial	Handle type				Knob attachment, ERAGONaxial
		HF / mono 	HF / mono 		
All jaw inserts and sheaths can also be combined with ERAGONaxial.	with locking mechanism, rotatable	without locking mechanism, rotatable	with locking mechanism, rotatable	with locking mechanism, non rotatable	
Product No.	83930082	83930083	83930084	83930085	8988

Jaw insert 	Sheath tube, insulated 		Handle type HF / mono  with locking mechanism, rotatable	Complete instrument • Jaw Insert • Sheath • Handle
	WL 330 mm	WL 450 mm		
Product No.	8393933	8394933	83930074	Bundle No.
 Grasping and dissecting forceps "Maryland" curved, with fine cross-cut toothing, double jaw action, JL= 21 mm	8393.281	•	•	83932817
	8394.281		•	83942817
 Grasping and dissecting forceps long, double jaw action, JL= 24 mm	8393194	•	•	83931947
	8394194		•	83941947
 Grasping and dissecting forceps curved, double jaw action, JL= 19 mm	8393240	•	•	83932407
	8394240		•	83942407





* JL = Jaw length when jaws closed (approximate measurements)





HF connecting cable see page 87.

ERAGON

ERAGON modular

modular instruments 5 mm, insulated

ERAGON axial	Handle type				Knob attachment, ERAGONaxial
		HF / mono 	HF / mono 		
All jaw inserts and sheaths can also be combined with ERAGONaxial.	with locking mechanism, rotatable	without locking mechanism, rotatable	with locking mechanism, rotatable	with locking mechanism, non rotatable	
Product No.	83930082	83930083	83930084	83930085	8988

Jaw insert 	Sheath tube, insulated		Handle type HF / mono 	Complete instrument • Jaw Insert • Sheath • Handle	
	WL 330 mm	WL 450 mm			
	Product No.	8393933	8394933	83930074	Bundle No.
 Grasping and dissecting forceps "Mixer" angled, fine pyramidal-shaped teeth, double jaw action, JL= 22 mm	8393.283	●		●	83932837
 Grasping and dissecting forceps right-angled, double jaw action, JL= 18 mm	8393192	●		●	83931927
	8394192		●	●	83941927
 Grasping and dissecting forceps short, fine tip, double jaw action, JL= 19 mm	8393200	●		●	83932007
	8394200		●	●	83942007







* JL = Jaw length when jaws closed (approximate measurements)





HF connecting cable see page 87.

ERAGON

ERAGON modular

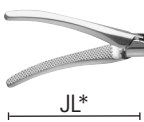
modular instruments 5 mm, insulated

	Handle type				Knob attachment, ERAGONaxial 	
	 with locking mechanism, rotatable	 without locking mechanism, rotatable	 with locking mechanism, rotatable	 with locking mechanism, non rotatable		
All jaw inserts and sheaths can also be combined with ERAGONaxial.	Product No.	83930082	83930083	83930084	83930085	8988

Jaw insert  JL*	Sheath tube, insulated		Handle type HF / mono  with locking mechanism, rotatable	Complete instrument • Jaw Insert • Sheath • Handle	
	Product No.	WL 330 mm			WL 450 mm
 Grasping and dissecting forceps long, double jaw action, JL= 30 mm	8393197	●		●	83931977
	8394197		●	●	83941977
 Grasping forceps curved, fine tip, double jaw action, JL= 33 mm	8393198	●		●	83931987
	8394198		●	●	83941987
 Grasping and dissecting forceps long, fine tip, double jaw action, JL= 32 mm	8393199	●		●	83931997
	8394199		●	●	83941997





* JL = Jaw length when jaws closed (approximate measurements)







HF connecting cable see page 87.

ERAGON

ERAGON modular

modular instruments 5 mm, insulated

ERAGON axial	Handle type				Knob attachment, ERAGONaxial
		HF / mono 	HF / mono 		
All jaw inserts and sheaths can also be combined with ERAGONaxial.	with locking mechanism, rotatable	without locking mechanism, rotatable	with locking mechanism, rotatable	with locking mechanism, non rotatable	
Product No.	83930082	83930083	83930084	83930085	8988

Jaw insert 	Sheath tube, insulated 	Handle type		Complete instrument • Jaw Insert • Sheath • Handle
		HF / mono 	HF / mono 	
	WL 330 mm	without locking mechanism, rotatable	with locking mechanism, rotatable	
Product No.	8393933	83930073	83930074	Bundle No.
 Grasping and dissecting forceps , fine pyramid-shaped toothing, slimline, double jaw action, JL= 18 mm	●		●	83932897
 Dissecting forceps, "Petelin" , angled 30° left, with horizontal serration, single jaw action, JL= 17 mm	●		●	83932827
 Grasping and dissecting forceps, "Dolphin" angled, fine cross-cut toothing, with jaw throat, slimline, double jaw action, JL=17 mm	●	●		83932857





* JL = Jaw length when jaws closed (approximate measurements)







HF connecting cable see page 87.

ERAGON

ERAGON modular

modular instruments 5 mm, insulated

ERAGON axial	Handle type				Knob attachment, ERAGONaxial
		HF / mono 	HF / mono 		
All jaw inserts and sheaths can also be combined with ERAGONaxial.	with locking mechanism, rotatable	without locking mechanism, rotatable	with locking mechanism, rotatable	with locking mechanism, non rotatable	
Product No.	83930082	83930083	83930084	83930085	8988

Jaw insert 	Sheath tube, insulated 			Handle type		Complete instrument • Jaw Insert • Sheath • Handle	
	WL 260 mm	WL 330 mm	WL 450 mm		HF / mono 		
	Product No.	8392933	8393933	8394933	83930072	83930074	Bundle No.
 Grasping and dissecting forceps , short rounded jaws, double jaw action, JL= 15 mm	8393230		●		●		83932307
	8394230			●	●		83942307
 Atraumatic grasping forceps , fenestrated, with cross-cut tothing, double jaw action, JL= 19 mm	8392.181	●				●	83921817
	8393.181		●			●	83931817
	8394.181			●		●	83941817
 Plate-shaped grasping forceps , fenestrated with fine cross-cut tothing, double jaw action, JL= 18 mm	8393.182		●			●	83931827





* JL = Jaw length when jaws closed (approximate measurements)







HF connecting cable see page 87.

ERAGON

ERAGON modular

modular instruments 5 mm, insulated

ERAGON axial	Handle type				Knob attachment, ERAGONaxial
		HF / mono 	HF / mono 		
All jaw inserts and sheaths can also be combined with ERAGONaxial.	with locking mechanism, rotatable	without locking mechanism, rotatable	with locking mechanism, rotatable	with locking mechanism, non rotatable	
Product No.	83930082	83930083	83930084	83930085	8988

Jaw insert 	Sheath tube, insulated		Handle type		Complete instrument • Jaw Insert • Sheath • Handle
	WL 330 mm	WL 450 mm	without locking mechanism, rotatable 	with locking mechanism, rotatable 	
Product No.	8393933	8394933	83930073	83930074	Bundle No.
 Grasping and dissecting forceps , fine cross-cut toothing, double jaw action, JL= 21 mm	●		●		83931837
 Grasping and dissecting forceps , fenestrated, fine horizontal serrations, single jaw action, JL= 21 mm	●			●	83931857
 Grasping and dissecting forceps , fenestrated, fine horizontal serrations, single jaw action, JL= 26 mm	●			●	83931847
	8394.184		●	●	83941847





* JL = Jaw length when jaws closed (approximate measurements)





HF connecting cable see page 87.

ERAGON

ERAGON modular

modular instruments 5 mm, insulated

ERAGON axial	Handle type				Knob attachment, ERAGONaxial
		HF / mono 	HF / mono 		
All jaw inserts and sheaths can also be combined with ERAGONaxial.	with locking mechanism, rotatable	without locking mechanism, rotatable	with locking mechanism, rotatable	with locking mechanism, non rotatable	
Product No.	83930082	83930083	83930084	83930085	8988

Jaw insert 	Sheath tube, insulated		Handle type 	Complete instrument • Jaw Insert • Sheath • Handle	
	WL 330 mm	WL 450 mm			
	Product No.	8393933	8394933	83930072	Bundle No.
	8393250	●		●	83932507
Grasping forceps atraumatic, fenestrated, fine cross toothing, double jaw action, JL= 25 mm	8394250		●	●	83942507
	8393229	●		●	83932297
Atraumatic grasping forceps with double window, curved, single jaw action, JL= 32 mm	8394229		●	●	83942297
	8393249	●		●	83932497
Atraumatic intestinal grasping forceps , single fenestration, double jaw action, JL= 38 mm	8394249		●	●	83942497





* JL = Jaw length when jaws closed (approximate measurements)







HF connecting cable see page 87.

ERAGON

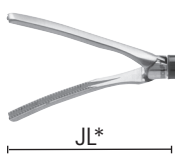
ERAGON modular

modular instruments 5 mm, insulated

ERAGON axial	Handle type				Knob attachment, ERAGONaxial
		HF / mono 	HF / mono 		
All jaw inserts and sheaths can also be combined with ERAGONaxial.	with locking mechanism, rotatable	without locking mechanism, rotatable	with locking mechanism, rotatable	with locking mechanism, non rotatable	
Product No.	83930082	83930083	83930084	83930085	8988

Jaw insert 	Sheath tube, insulated		Handle type		Complete instrument • Jaw Insert • Sheath • Handle	
	WL 330 mm	WL 450 mm		HF / mono 		
	Product No.	8393933	8394933	83930072	83930074	Bundle No.
 Grasping forceps "Debakey" curved, double jaw action, JL= 35 mm	8393256	●			●	83932567
 Grasping forceps "Debakey" double jaw action, JL= 47 mm	8393258	●			●	83932587
	8394258		●		●	83942587
 Grasping and dissecting forceps, fine cross-cut toothing, fenestrated, double jaw action, with spring jaws, JL= 47 mm	8393.189	●		●		83931897
	8394.189		●	●		83941897





* JL = Jaw length when jaws closed (approximate measurements)







HF connecting cable see page 87.

ERAGON

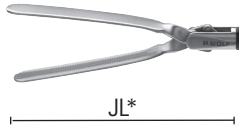
ERAGON modular

modular instruments 5 mm, insulated

ERAGON axial	Handle type				Knob attachment, ERAGONaxial
		HF / mono 	HF / mono 		
All jaw inserts and sheaths can also be combined with ERAGONaxial.	with locking mechanism, rotatable	without locking mechanism, rotatable	with locking mechanism, rotatable	with locking mechanism, non rotatable	
Product No.	83930082	83930083	83930084	83930085	8988

Jaw insert	Sheath tube, insulated	Handle type	Complete instrument
	 WL 330 mm	 with locking mechanism, rotatable	<ul style="list-style-type: none"> Jaw Insert Sheath Handle
Product No.	8393933	83930072	Bundle No.
 Grasping and dissecting forceps "Debaquey" , atraumatic clip, longitudinal grooves with fine cross-cut toothing, double jaw action, with spring jaws, JL= 47 mm	●	●	83932917
 Grasping and dissecting forceps "Debaquey" , atraumatic clip, double jaw action, JL= 39 mm	●	●	83931907
 Grasping and dissecting forceps "Debaquey" , atraumatic clip, double jaw action, JL= 48 mm	●	●	83931917





* JL = Jaw length when jaws closed (approximate measurements)







HF connecting cable see page 87.

ERAGON

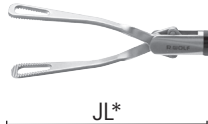
ERAGON modular

modular instruments 5 mm, insulated

ERAGON axial	Handle type				Knob attachment, ERAGONaxial
		HF / mono 	HF / mono 		
All jaw inserts and sheaths can also be combined with ERAGONaxial.	with locking mechanism, rotatable	without locking mechanism, rotatable	with locking mechanism, rotatable	with locking mechanism, non rotatable	
Product No.	83930082	83930083	83930084	83930085	8988

Jaw insert 	Sheath tube, insulated 		Handle type 	Complete instrument • Jaw Insert • Sheath • Handle	
	WL 330 mm	WL 450 mm			
	Product No.	8393933	8394933	83930072	Bundle No.
 Grasping and extraction forceps , triangular, fenestrated, with fine cross-cut toothing, double jaw action, with spring jaws, JL= 37 mm	8393.188	•		•	83931887
 Grasping forceps "Babcock" , grasping surface with fine cross-cut toothing, double jaw action, JL= 24 mm	8393.186	•		•	83931867
 Grasping forceps "Babcock" , grasping surface with fine cross-cut toothing, double jaw action, JL= 26 mm	8393.187	•		•	83931877
	8394.187		•	•	83941877





* JL = Jaw length when jaws closed (approximate measurements)







HF connecting cable see page 87.

ERAGON

ERAGON modular

modular instruments 5 mm, insulated

ERAGON axial	Handle type				Knob attachment, ERAGONaxial
		HF / mono 	HF / mono 		
All jaw inserts and sheaths can also be combined with ERAGONaxial.	with locking mechanism, rotatable	without locking mechanism, rotatable	with locking mechanism, rotatable	with locking mechanism, non rotatable	
Product No.	83930082	83930083	83930084	83930085	8988

Jaw insert 	Sheath tube, insulated		Handle type		Complete instrument • Jaw Insert • Sheath • Handle	
	WL 330 mm	WL 450 mm		HF / mono 		
	Product No.	8393933	8394933	83930072	83930074	Bundle No.
	8393242	●		●		83932427
Grasping forceps , fenestrated, single jaw action, JL= 17 mm	8394242		●	●		83942427
	8393.481	●			●	83934817
Universal grasping forceps pyramid-shaped toothing and cross-cut toothing, double jaw action, JL= 18 mm						
	8393.482	●		●		83934827
Universal holding forceps pyramid-shaped toothing and cross-cut toothing, double jaw action, JL= 26 mm						





* JL = Jaw length when jaws closed (approximate measurements)







HF connecting cable see page 87.

ERAGON

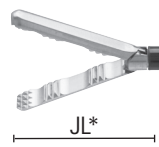
ERAGON modular

modular instruments 5 mm, insulated

ERAGON axial	Handle type				Knob attachment, ERAGONaxial
		HF / mono 	HF / mono 		
All jaw inserts and sheaths can also be combined with ERAGONaxial.	with locking mechanism, rotatable	without locking mechanism, rotatable	with locking mechanism, rotatable	with locking mechanism, non rotatable	
Product No.	83930082	83930083	83930084	83930085	8988

Jaw insert 	Sheath tube, insulated 		Handle type 	Complete instrument • Jaw Insert • Sheath • Handle	
	WL 330 mm	WL 450 mm			
JL*	Product No.	8393933	8394933	83930072	Bundle No.
	8393223	●		●	83932237
Grasping forceps , atraumatic, fine cross-cut tothing, double jaw action, JL= 29 mm	8394223		●	●	83942237
	8393.292	●		●	83932925
Atraumatic grasping forceps , jaw throat with wavy tooth edge, single jaw action, JL= 26 mm	8394.292		●	●	839429255
	8393.293	●		●	83932935
Atraumatic grasping forceps , jaw throat with wavy tooth edge, double jaw action, JL= 26 mm	8394.293		●	●	839329355





* JL = Jaw length when jaws closed (approximate measurements)







HF connecting cable see page 87.

ERAGON

ERAGON modular

modular instruments 5 mm, insulated

ERAGON axial	Handle type				Knob attachment, ERAGONaxial
		HF / mono 	HF / mono 		
All jaw inserts and sheaths can also be combined with ERAGONaxial.	with locking mechanism, rotatable	without locking mechanism, rotatable	with locking mechanism, rotatable	with locking mechanism, non rotatable	
Product No.	83930082	83930083	83930084	83930085	8988

Jaw insert	Sheath tube, insulated	Handle type	Complete instrument
	 WL 330 mm	HF / mono  with locking mechanism, rotatable	• Jaw Insert • Sheath • Handle
Product No.	8393933	83930074	Bundle No.
 Grasping and dissecting forceps , fine pyramid-shaped toothings, slimline, double jaw action, JL= 14 mm	●	●	83932887
 Grasping forceps , with row of teeth, double jaw action, JL= 17 mm	●	●	83934857
 Grasping and dissecting forceps , atraumatic, fine cross toothings, double jaw action, JL= 16 mm	●	●	83932107





* JL = Jaw length when jaws closed (approximate measurements)







HF connecting cable see page 87.

ERAGON

ERAGON modular

modular instruments 5 mm, insulated

ERAGON axial	Handle type				Knob attachment, ERAGONaxial
		HF / mono 	HF / mono 		
All jaw inserts and sheaths can also be combined with ERAGONaxial.	with locking mechanism, rotatable	without locking mechanism, rotatable	with locking mechanism, rotatable	with locking mechanism, non rotatable	
Product No.	83930082	83930083	83930084	83930085	8988

Jaw insert 	Sheath tube, insulated		Handle type			Complete instrument • Jaw Insert • Sheath • Handle
	WL 330 mm	WL 450 mm	with locking mechanism, rotatable 	without locking mechanism, rotatable 	with locking mechanism, rotatable 	
Product No.	8393933	8394933	83930072	83930073	83930074	Bundle No.
 Grasping and dissecting forceps, double jaw action, JL= 16 mm	8393193	●	●			83931937
	8394193		●	●		83941937
 Grasping and dissecting forceps atraumatic, double jaw action, JL= 19 mm	8393220	●			●	83932207
	8394220		●		●	83942207
 Atraumatic grasping forceps smooth, double jaw action, JL= 18 mm	8393.195	●			●	83931957
	8394.195		●		●	83941957





* JL = Jaw length when jaws closed (approximate measurements)







HF connecting cable see page 87.

ERAGON

ERAGON modular

modular instruments 5 mm, insulated

ERAGON axial	Handle type				Knob attachment, ERAGONaxial
		HF / mono 	HF / mono 		
All jaw inserts and sheaths can also be combined with ERAGONaxial.	with locking mechanism, rotatable	without locking mechanism, rotatable	with locking mechanism, rotatable	with locking mechanism, non rotatable	
Product No.	83930082	83930083	83930084	83930085	8988

Jaw insert	Sheath tube, insulated	Handle type	Complete instrument
	 WL 330 mm	HF / mono  with locking mechanism, rotatable	• Jaw Insert • Sheath • Handle
Product No.	8393933	83930074	Bundle No.
 Grasping forceps , with one tooth, fine cross-cut toothing, slimline, double jaw action, JL= 19 mm	●	●	83934867
 Grasping forceps , with two teeth, fine cross-cut toothing, single jaw action, JL= 17 mm	●	●	83934877
 Grasping and extraction forceps , "pike-mouth", double jaw action, JL= 20 mm	●	●	83934837





* JL = Jaw length when jaws closed (approximate measurements)







HF connecting cable see page 87.

ERAGON

ERAGON modular

modular instruments 5 mm, insulated

ERAGON axial	Handle type				Knob attachment, ERAGONaxial
		HF / mono 	HF / mono 		
All jaw inserts and sheaths can also be combined with ERAGONaxial.	with locking mechanism, rotatable	without locking mechanism, rotatable	with locking mechanism, rotatable	with locking mechanism, non rotatable	
Product No.	83930082	83930083	83930084	83930085	8988





Jaw insert 	Sheath tube, insulated 		Handle type 	Complete instrument • Jaw Insert • Sheath • Handle
	WL 330 mm	WL 450 mm		
Product No.	8393933	8394933	83930072	Bundle No.
 Grasping and extraction myoma grasping forceps, 2x3-claw, single jaw action, JL= 29 mm	8393.488	●	●	83934887
 Grasping forceps with two teeth, wavy grasping surface atraumatic, double jaw action, JL= 26 mm	8393.490	●	●	83934907
	8394.490		●	83944907
 Claw grasping forceps, double jaw action, JL= 47 mm	8393.494	●	●	83934945





* JL = Jaw length when jaws closed (approximate measurements)

HF connecting cable see page 87.

ERAGON modular

modular instruments 5 mm, insulated

ERAGON axial	Handle type				Knob attachment, ERAGONaxial
		HF / mono 	HF / mono 		
All jaw inserts and sheaths can also be combined with ERAGONaxial.	with locking mechanism, rotatable	without locking mechanism, rotatable	with locking mechanism, rotatable	with locking mechanism, non rotatable	
Product No.	83930082	83930083	83930084	83930085	8988

Jaw insert 	Sheath tube, insulated		Handle type HF / mono 	Complete instrument • Jaw Insert • Sheath • Handle
	WL 330 mm	WL 450 mm		
Product No.	8393933	8394933	83930073	Bundle No.
 Grasping coagulating forceps , distal cross-cut toothing with cupped jaw, double jaw action, JL= 15 mm	8393.287	●	●	83932877
 Biospy forceps , with pins, double jaw action, JL= 13 mm	8393.091	●	●	83930917
	8394.091	●	●	83940917
 Biospy forceps , severing, single jaw action, JL= 14 mm	8393.092	●	●	83930927
	8394.092	●	●	83940927







* JL = Jaw length when jaws closed (approximate measurements)





HF connecting cable see page 87.

ERAGON

ERAGON modular

modular instruments 5 mm, insulated

 All jaw inserts and sheaths can also be combined with ERAGONaxial.	Handle type				Knob attachment, ERAGONaxial 
	 with locking mechanism, rotatable	HF / mono  without locking mechanism, rotatable	HF / mono  with locking mechanism, rotatable	 with locking mechanism, non rotatable	
Product No.	83930082	83930083	83930084	83930085	8988



Jaw insert 	Sheath tube, insulated 	Handle type HF / mono  without locking mechanism, rotatable	Complete instrument • Jaw Insert • Sheath • Handle
	WL 330 mm		
Product No.	8393933	83930073	Bundle No.
 Biospy forceps , pointed spoon forceps, single jaw action, JL= 20 mm	8393.093	●	●







* JL = Jaw length when jaws closed (approximate measurements)

HF connecting cable see page 87.

ERAGON modular

modular scissors 5 mm, insulated

 All jaw inserts and sheaths can also be combined with ERAGONaxial.	Handle type HF / mono  without locking mechanism, rotatable		Knob attachment, ERAGONaxial 
	Product No.	83930083	8988



Jaw insert  JL*	Sheath tube, insulated 		Handle type HF / mono  without locking mechanism, rotatable	Complete instrument • Jaw Insert • Sheath • Handle
	WL 330 mm	WL 450 mm		
 Scissors "Metzenbaum" , curved, double jaw action, JL= 23 mm	●	●	●	83930417
8393.041	●	●	●	83940417
8394.041	●	●	●	83932437
 Scissors "Metzenbaum" , curved, double jaw action, JL= 21.2 mm	●	●	●	83942437
8393243	●	●	●	83930447
8394243	●	●	●	83930447
 Micro-scissors "Metzenbaum" , curved double jaw action, JL= 18 mm	●	●	●	83930447
8393.044	●	●	●	83930447







* JL = Jaw length when jaws closed (approximate measurements)

HF connecting cable see page 87.

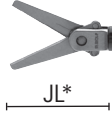
ERAGON modular

modular scissors 5 mm, insulated

 All jaw inserts and sheaths can also be combined with ERAGONaxial.	Handle type HF / mono  without locking mechanism, rotatable		Knob attachment, ERAGONaxial 
	Product No.	83930083	8988



Jaw insert 	Sheath tube, insulated 		Handle type HF / mono  without locking mechanism, rotatable	Complete instrument • Jaw Insert • Sheath • Handle
	Product No.	WL 330 mm		
 Scissors slimline, straight, double jaw action, JL= 20 mm	8393.045	●	●	83930457
 Scissors fine-toothed, curved, double jaw action, JL= 26 mm	8393246	●	●	83932467
	8394246	●	●	83942467
 Scissors fine-toothed, fine tip, double jaw action, JL= 22 mm	8393248	●	●	83932487
	8394248	●	●	83942487



* JL = Jaw length when jaws closed (approximate measurements)

HF connecting cable see page 87.

ERAGON modular

modular scissors 5 mm, insulated

 <p>All jaw inserts and sheaths can also be combined with ERAGONaxial.</p>	Handle type		Knob attachment, ERAGONaxial 
	HF / mono  without locking mechanism, rotatable		
Product No.	83930083		8988





Jaw insert  JL*	Sheath tube, insulated		Handle type HF / mono  without locking mechanism, rotatable	Complete instrument • Jaw Insert • Sheath • Handle
	Product No.	WL 330 mm		
 Hook Scissors, serrated, single jaw action, JL= 14 mm	8393.081	●	●	83930817
	8394.081		●	83940817



* JL = Jaw length when jaws closed (approximate measurements)

HF connecting cable see page 87.

ERAGON modular

modular knot pusher 5 mm, insulated

 All jaw inserts and sheaths can also be combined with ERAGONaxial.	Handle type		Knob attachment, ERAGONaxial 
	 with locking mechanism, rotatable	 with locking mechanism, non rotatable	
Product No.	83930082	83930085	8988

Jaw insert 	Sheath tube, insulated		Handle type  with locking mechanism, rotatable	Complete instrument • Jaw Insert • Sheath • Handle
	WL 330 mm	WL 450 mm		
Product No.	8393933	8394933	83930072	Bundle No.
 Extracorporeal knot pusher, with distal fork, double jaw action, JL= 17 mm	8393.345	•	•	83933457
	8394345	•	•	83943457

* JL = Jaw length when jaws closed (approximate measurements)

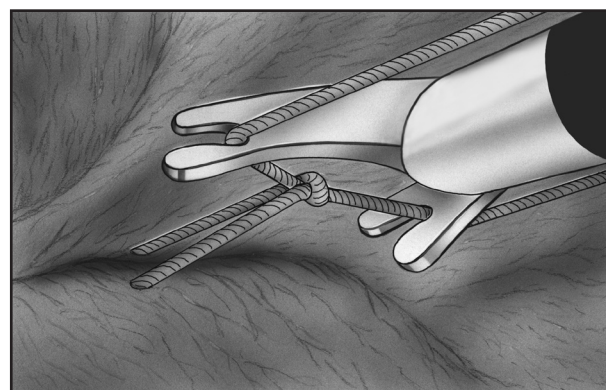









Extracorporeal knotting technique

ERAGON

ERAGON_{modular}

Gastric Band Manipulator 5 mm, insulated

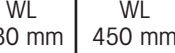
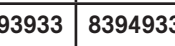
 All jaw inserts and sheaths can also be combined with ERAGONaxial.	Handle type		Knob attachment, ERAGONaxial 
	 with locking mechanism, rotatable	 with locking mechanism, not rotatable	
Product No.	83930082	83930085	8988

Jaw insert   JL*	Sheath tube, insulated		Handle type		Complete instrument • Jaw insert • Sheath • Handle
		 WL 330 mm	 WL 450 mm	 with locking mechanism, rotatable	
Product No.	8393933	8394933	83930072		Bundle No.
 Gastric band manipulator, JL= 45 mm	8393253	●		●	83932537
	8394253		●	●	83942537

* JL = Jaw length when jaws closed (approximate measurements)

ERAGON

ERAGON modular

sheath tube with cm scale, insulated

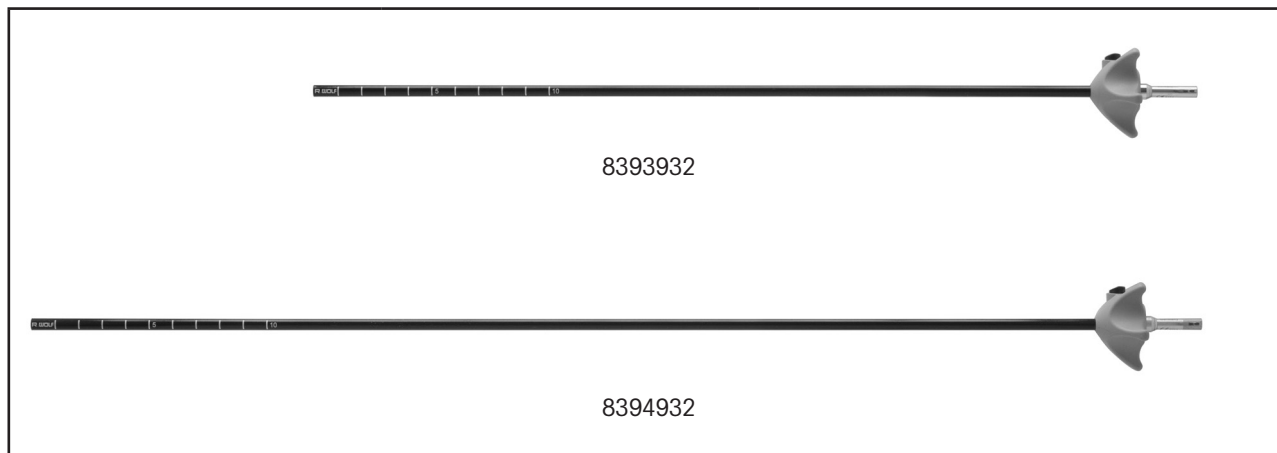











	∅	WL	Product No.
 ERAGON modular sheath tube, monopolar, with distal cm scale	5 mm	330 mm	8393932
		450 mm	8394932

ERAGON

ERAGON modular

modular instruments 10 mm, non-insulated

 <p>All jaw inserts and sheaths can also be combined with ERAGONaxial.</p>	Handle type		Knob attachment, ERAGONaxial 
	 with locking mechanism, rotatable	 with locking mechanism, non rotatable	
Product No.	83930082	83930085	8988





Jaw insert 	Sheath tube, non-insulated		Handle type  with locking mechanism, rotatable	Complete instrument • Jaw Insert • Sheath • Handle	
	WL 330 mm	WL 450 mm			
	Product No.	8395902	8396902	83930072	Bundle No.
 Grasping and dissecting forceps "Maryland" , double jaw action, JL= 36 mm	8395.225	●		●	83952257
	8396225		●	●	83962257
 Dissecting forceps, right angled , double jaw action, JL= 35 mm	8395.226	●		●	83952268
	8396226		●	●	83962267
 Atraumatic grasping forceps "Babcock" , large distal grasping surface with fine horizontal serration, double jaw action, JL= 42 mm	8395.187	●		●	83951877
	8396187		●	●	83961877
 Atraumatic grasping forceps "Babcock" , double jaw action, JL= 38 mm	8395.214	●		●	83952148







* JL = Jaw length when jaws closed (approximate measurements)

ERAGON

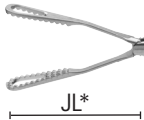
ERAGON modular

modular instruments 10 mm, non-insulated

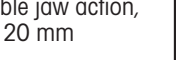
 <p>All jaw inserts and sheaths can also be combined with ERAGONaxial.</p>	Handle type		Knob attachment, ERAGONaxial 
	 with locking mechanism, rotatable	 with locking mechanism, non rotatable	
Product No.	83930082	83930085	8988

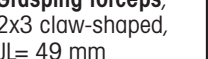







Jaw insert 	Sheath tube, non-insulated		Handle type  with locking mechanism, rotatable	Complete instrument • Jaw Insert • Sheath • Handle
	WL 330 mm	WL 450 mm		
Product No.	8395902	8396902	83930072	Bundle No.
 Atraumatic plate-shaped grasping forceps , double jaw action, JL= 50 mm	●		●	83952347
 Grasping forceps , with alligator jaws double jaw action, JL= 20 mm	●		●	83952368
 Grasping forceps , with alligator jaws double jaw action, JL= 20 mm		●	●	83962367
 Grasping forceps , 2x3 claw-shaped, JL= 49 mm	●		●	83952048
 Grasping forceps , 2x3 claw-shaped, JL= 49 mm		●	●	83952047

ERAGON

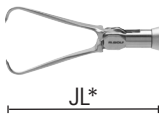
* JL = Jaw length when jaws closed (approximate measurements)

ERAGON modular

modular instruments 10 mm, non-insulated







ERAGON axial		Handle type		Knob attachment, ERAGONaxial	
		 with locking mechanism, rotatable	 with locking mechanism, non rotatable		
All jaw inserts and sheaths can also be combined with ERAGONaxial.		Product No.	83930082	83930085	8988
Jaw insert 	Sheath tube, non-insulated 	Handle type 		Complete instrument • Jaw Insert • Sheath • Handle	
Product No.	8395902	83930072			Bundle No.
 Claw-type grasping forceps , with additional row of teeth, double jaw action, JL= 38 mm	8395490	•	•	83954907	
 Claw grasping forceps , double jaw action, JL= 38 mm	8395.489	•	•	83954897	
 Spoon forceps , single jaw action, JL= 31 mm	8395.244	•	•	83952448	

* JL = Jaw length when jaws closed (approximate measurements)

ERAGON

ERAGON modular



modular instruments 10 mm, non-insulated





 	Sheath tube, non-insulated  WL 380 mm	Handle type  with locking mechanism without HF connector	Complete instrument <ul style="list-style-type: none"> • Jaw insert • Sheath • Handle
Product No.	8397902	83930082	Bundle No.
 Anvil/Stapler head grasping forceps 30° angled, double jaw action	8397.655	●	●
 Manipulator for gastric banding 90° articuable, atraumatic dissector, branch with distal slot and hook	8397.654	●	83976558
			839765572
			83976547

* JL = Jaw length when jaws closed (approximate measurements)

ERAGON

Handle Type for modular systems

Handle type ERAGON_{modular}	mechanism, rotatable	with locking	without locking	with HF	without HF	Product No.
	•	•			•	83930072
	•		•	•		83930073
	•	•		•		83930074

Handle type ERAGON_{axial}	mechanism, rotatable	with locking	without locking	with HF	without HF	Product No.
	•	•			•	83930082
	•		•	•		83930083
	•	•		•		83930084
		•			•	83930085



Optional for 83930082 / 83930083 / 83930084:

Knob attachment





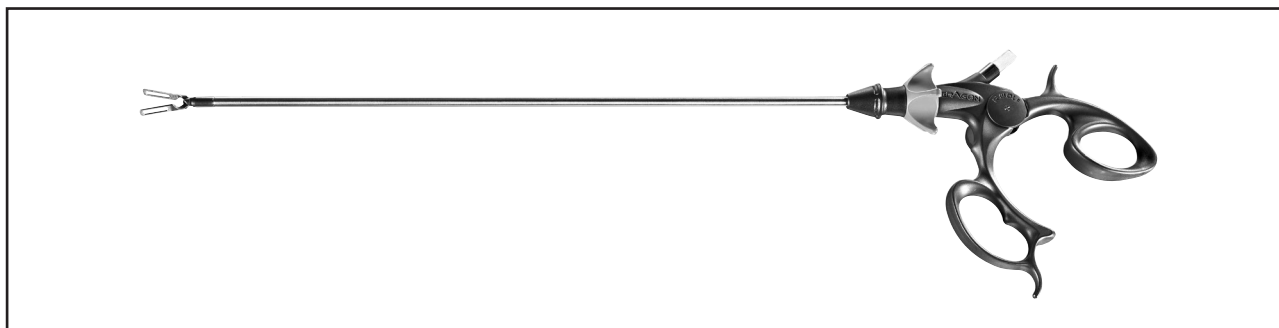

ERAGONaxial..... **8988**

All **ERAGON_{modular}** components are compatible with **ERAGON_{axial}**

ERAGON bipolar

modular bipolar instruments, 5.5 mm, rotatable



 <p>Jaw insert</p>	<p>Sheath</p>	 <p>Handle, rotatable</p>	<p>Complete instrument</p> <ul style="list-style-type: none"> • Jaw Insert • Sheath • Handle 	
	<p>WL 330 mm</p>			
	Product No.	83930921	839300102	Bundle No.
 <p>Grasping and dissecting forceps, JL=21 mm</p>	83930031	●	●	839300312
 <p>Grasping and dissecting forceps "Maryland", JL= 23 mm</p>	83930032	●	●	839300322
 <p>Grasping and dissecting forceps "Dolphin", JL= 21 mm</p>	83930033	●	●	839300332
 <p>Grasping forceps, fenestrated, JL= 23 mm</p>	83930034	●	●	839300342
 <p>Dissecting forceps "Hasskamp", JL= 19 mm</p>	83930035	●	●	839300352

* JL = Jaw length when jaws closed (approximate measurements)





Bipolar cable see page 88.

ERAGON

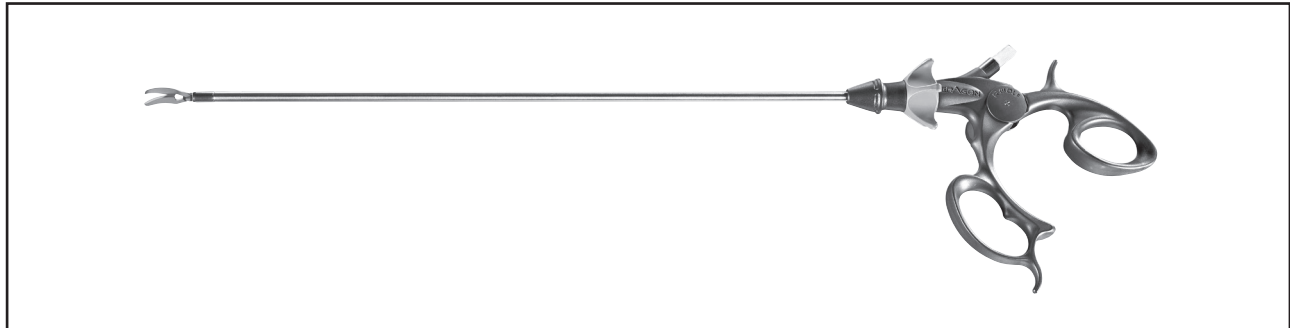
ERAGON bipolar

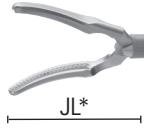
modular bipolar instruments, 5.5 mm, rotatable













<p>Jaw insert</p> 	<p>Sheath</p> 	<p>Handle, rotatable</p> 	<p>Complete instrument</p> <ul style="list-style-type: none"> • Jaw Insert • Sheath • Handle 	
	<p>WL 330 mm</p>			
	<p>Product No.</p>	<p>83930921</p>	<p>839300102</p>	<p>Bundle No.</p>
 <p>Metzenbaum scissors, JL= 22 mm</p>	<p>83930041</p>	<p>●</p>	<p>●</p>	<p>839300412</p>

* JL = Jaw length when jaws closed (approximate measurements)

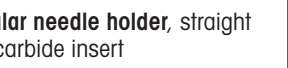
ERAGON

Bipolar cable see page 88.

Needle Holder 3.5 mm / 5 mm modular system



Inner section with sheath tube and irrigation tap				Axial handle	Complete instrument
					<ul style="list-style-type: none"> • Inner section with sheath tube • Handle
	Product No.	Ø	WL	8393.941	Bundle No.
 Modular needle holder, straight with carbide insert	8391.504	3.5 mm	310 mm	●	8391.501
 Modular needle holder, straight for straight needles	8393.504	5 mm	320 mm	●	8393.501
 Modular needle holder, straight with carbide insert	8393.505	5 mm	320 mm	●	8393.502
 Modular needle holder, straight with carbide insert	8394.505	5 mm	410 mm	●	8394.502
 Modular needle holder, curved right with carbide insert	8393.514	5 mm	320 mm	●	8393.511
 Modular needle holder, curved right with carbide insert	8394.514	5 mm	410 mm	●	8394.511
 Modular needle holder, curved left with carbide insert	8393.515	5 mm	320 mm	●	8393.512
 Modular needle holder, curved left with carbide insert	8394.515	5 mm	410 mm	●	8394.512
 Modular multifunction* needle holder by Sarbu	8393.506	5 mm	325 mm	●	8393.503
 Modular multifunction* needle holder by Sarbu	8394.506	5 mm	415 mm	●	8394.503

* with automatic needle alignment mechanism and cutting edge

Grasping Forceps, 5 mm

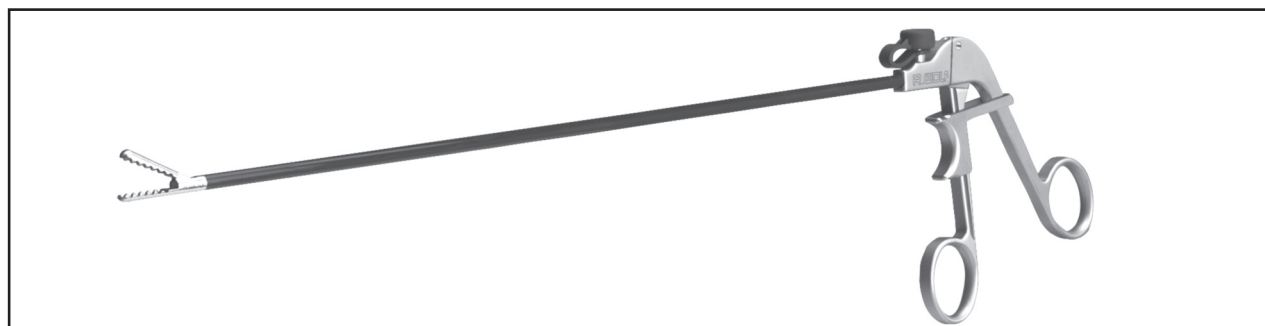
Single Piece Design, Slide-ratchet handle



Instrument	310 mm WL	Non-Rotatable	Rotatable
 <p>Wave Side Grasper, single action jaw</p>	●	8383.2927	8383.2925
 <p>Wave Side Grasper, double action jaw</p>	●	8383.2937	8383.2935
 <p>Retraction Grasper with two teeth</p>	●	8383.4897	N/A





Ergonomic handle with slide-ratchet for secure positioning of the jaw tip

LAPAROSCOPIC INSTRUMENTS

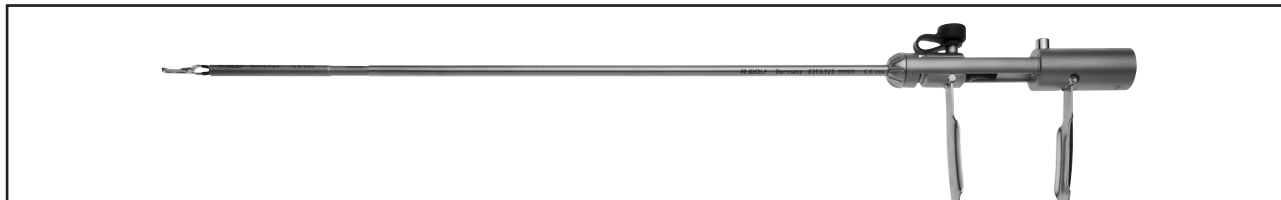
Bipolar Forceps 3.5 mm

with spring handle
modular system



Jaw insert	Outer tube	Screw-on cap with sleeve	Spring handle	Complete instrument	
	 WL 340 mm			<ul style="list-style-type: none"> • Jaw Insert • Outer tube • Screw-on cap • Spring handle 	
	Product No.	8391.921	8393.978	8393.975	Bundle No.
 Bipolar forceps	8391.715	●	●	●	8391.742

Spare parts:





Rubber cap 15220.019
Luer sealing cap 15023.153

Bipolar connecting cable see page 88.

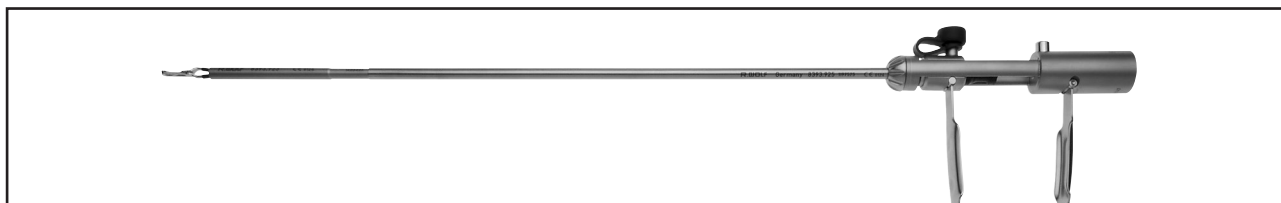
Bipolar Forceps 5 mm

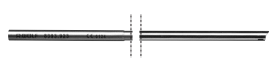
with spring handle
modular system





Jaw insert	Outer tube	Screw-on cap with sleeve	Spring handle	Complete instrument	
	 WL 300 mm			<ul style="list-style-type: none"> • Jaw Insert • Outer tube • Screw-on cap • Spring handle 	
	Product No.	8393.923	8393.925	8393.975	Bundle No.
 Bipolar grasping forceps with Teflon tooth	8393.705	•	•	•	*
 Bipolar grasping forceps, Kleppinger principle	8393.714	•	•	•	8393.741

*No bundle number available. Components need to be quoted separately.

Bipolar connecting cable see page 88.

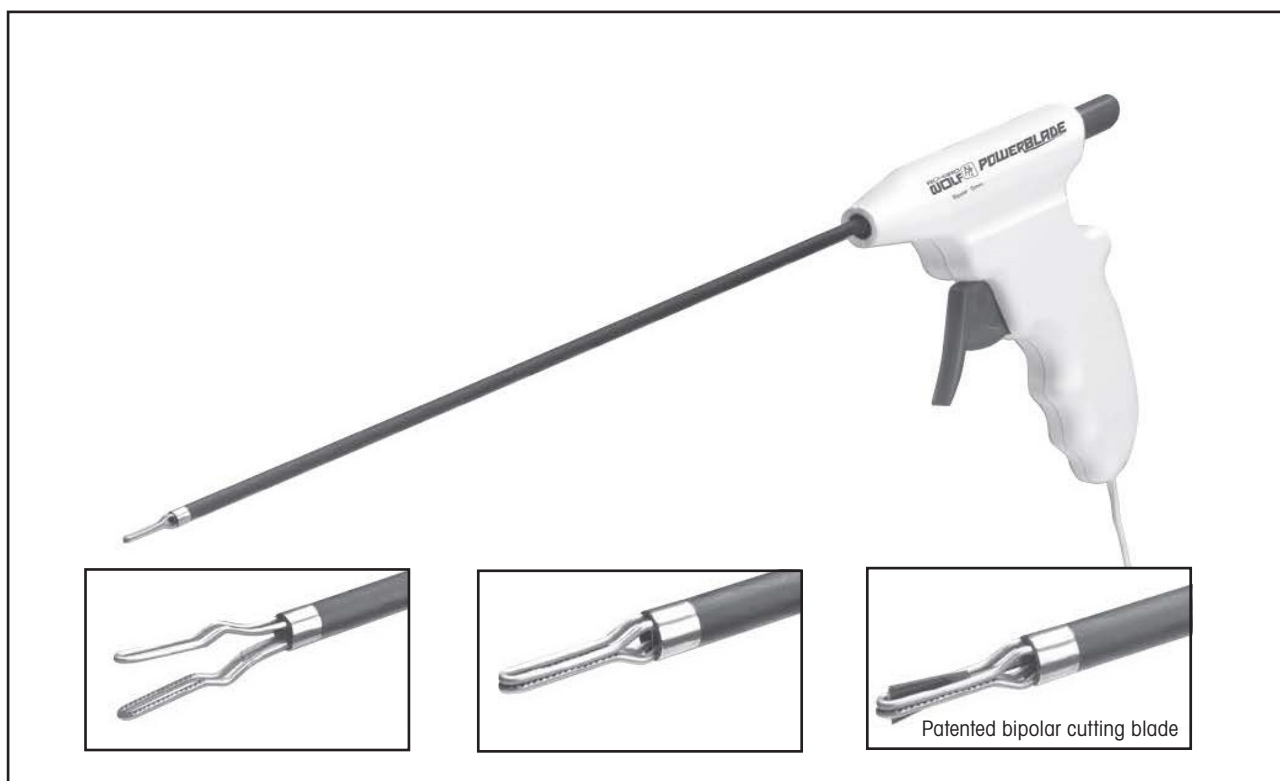
PowerBlade, Bipolar Forceps, 5 mm for bipolar cutting and coagulation



Connector for unit	Ø	WL	Quantity"	Product No.
 Connector for Richard Wolf generators	5 mm	310 mm	5/box	4393.3865
	5 mm	430 mm	5/box	4394.3865
 Connector for Valleylab, ConMed, ERBE style generators	5 mm	310 mm	5/box	4393.2865
	5 mm	430 mm	5/box	4394.2865

*Individually packed sterile, disposable.

Cholangiography Catheter Grasping Forceps 5 mm

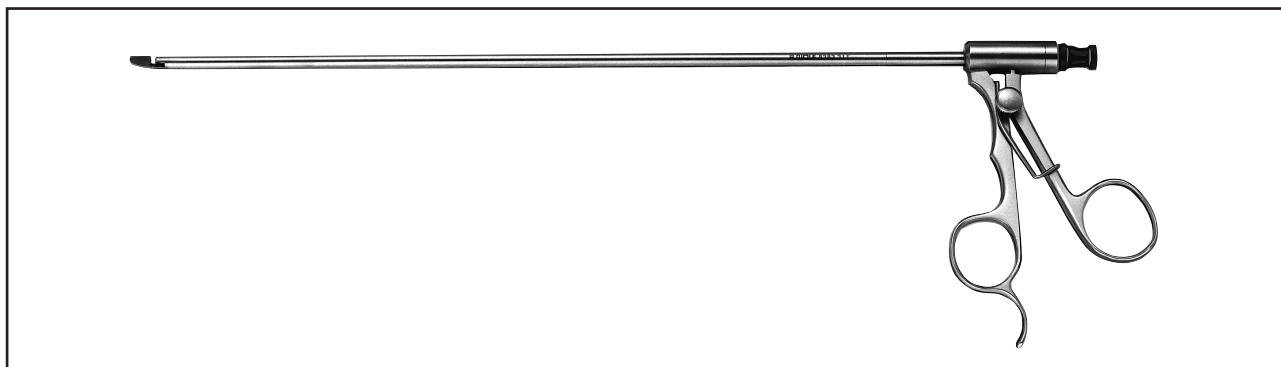

	WL 295 mm	Product No.
 Grasping forceps, for cholangiography catheter	●	8383.311

For introducing a cholangiography catheter up to 7 Fr. into the cystic duct.

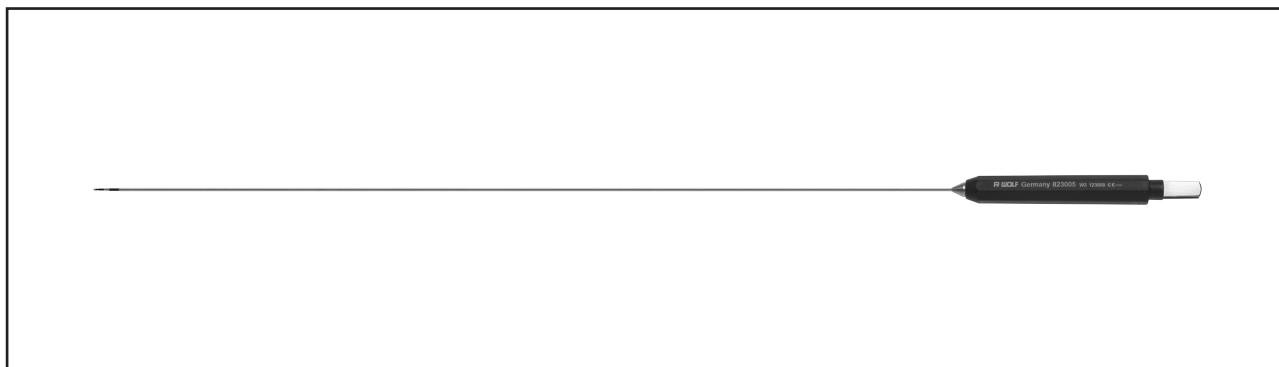

BipoTrode 1.6 mm / 5 Fr. Bipolar Electrode



	WL 360 mm	Product No.
 BipoTrode bipolar electrode	●	823005



- ❑ For precise dissection, preparation and coagulation using saline distension media, also for use in laparoscopy (e.g. in combination with trocar sleeve 8309.072 with trocar 8309.121)
- ❑ Small diameter of 5 Fr. allows use with hysteroscopes
- ❑ Made of semiflexible stainless steel so can be used with bent working channels but preferably with straight working channels of the compact Richard WOLF hysteroscopes
- ❑ Robust and ergonomic handle

Electrodes 2 mm
monopolar

		
	WL 400 mm	Type
 Coagulation button electrode	●	823.06

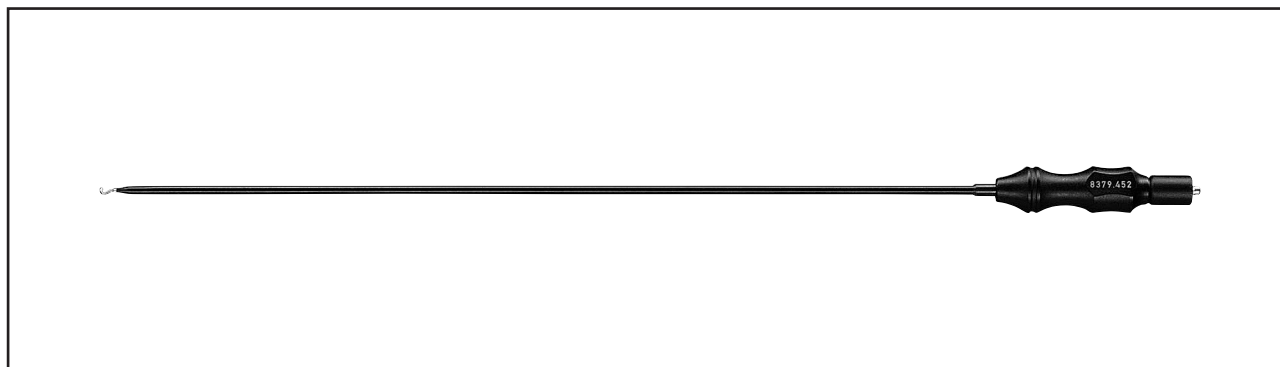
Electrodes 3.5 mm monopolar





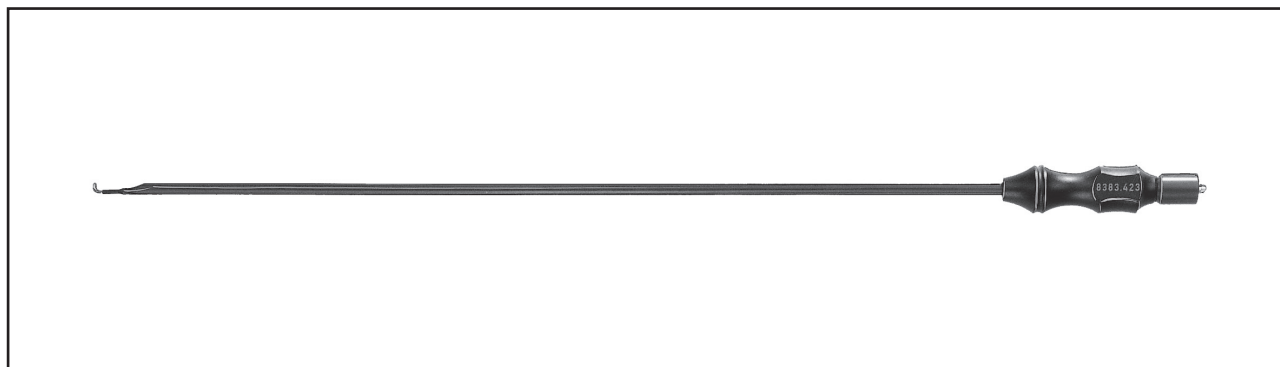

	WL 340 mm	Product No.
 Hook electrode	●	8379.452
 Needle electrode	●	8379.482
 Coagulation button electrode	●	8379.462

HF connecting cable see page 87.

Electrodes 5 mm monopolar



	WL 340 mm	WL 420 mm	WL 450 mm	Product No.
 Hook electrode	●			8383.423
		●		8384.423
 J-Hook electrode	●			8383.425
		●		8384.425
 Myoma dissector	●			8383429
 Needle electrode	●			8383.426
 Spatula electrode	●			8383.428

HF connecting cable see page 87.

Electrodes 5 mm
monopolar

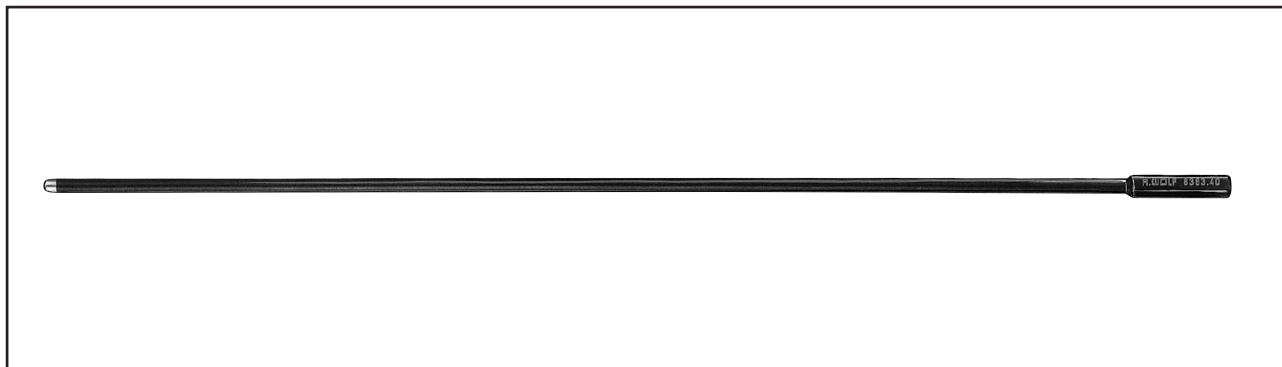

	WL 330 mm	WL 450 mm	Product No.
	●		8383.40
Button electrode		●	8384.40

HF connecting cable see page 87.

Suction-Irrigation Tubes 5 mm with Luer connector

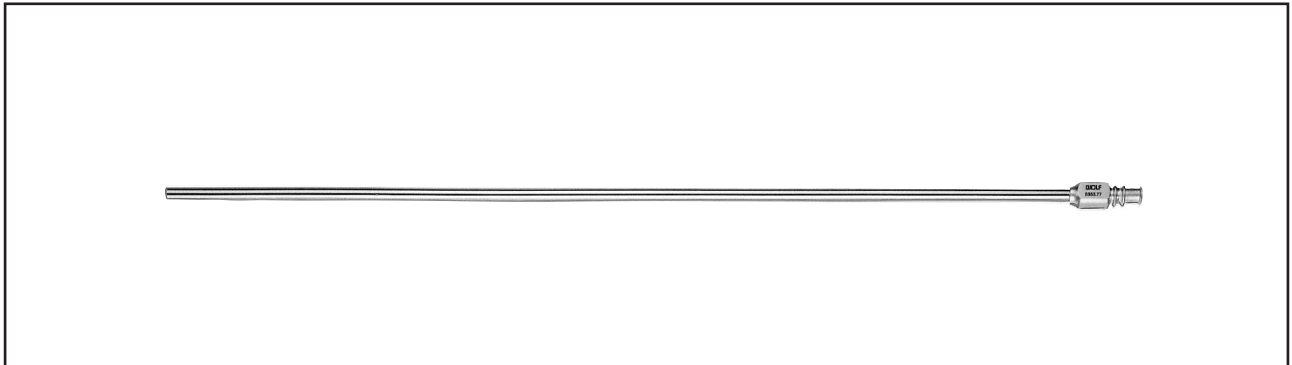

	WL 330 mm	Product No.
 Suction tube with Luer connector 3 mm capacity	●	8383.72

Suction Tube 5 mm with Luer connector and one valve

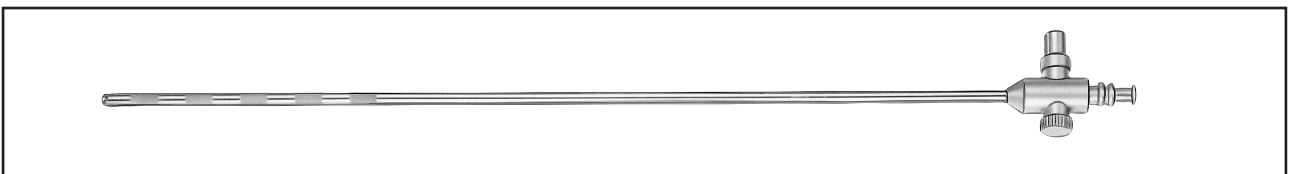

	WL 330 mm	WL 450 mm	Product No.
	●		8383.68
 Suction tube graduated, with Luer connector 3 mm		●	8384.68

LAPAROSCOPIC INSTRUMENTS

Combination Suction and Irrigation Tube 5 mm with two stop valves

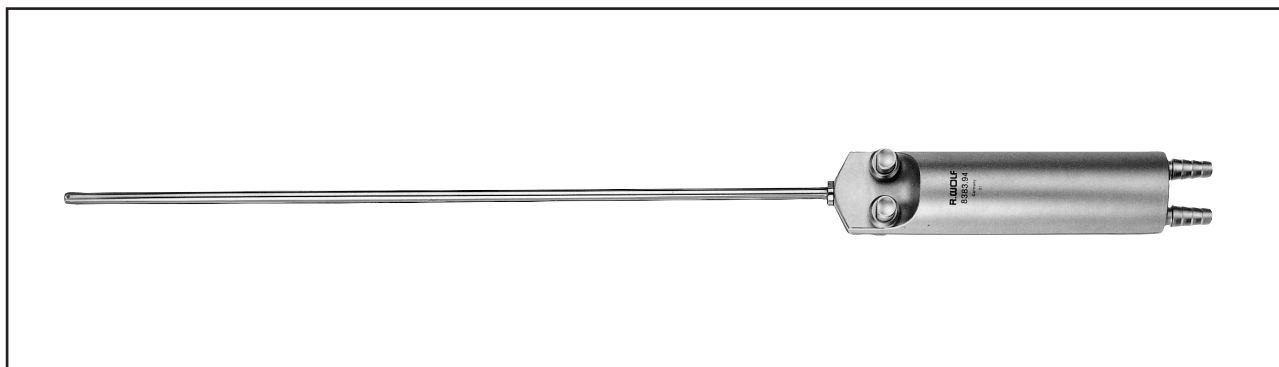

	WL 300 mm	Product No.
 Combination suction and irrigation tube with stop valves	●	8383.94

Coagulation-Suction Tubes 5 mm monopolar

with Luer connector and one valve





	WL 315 mm	WL 450 mm	Product No.
	●		8383.71*
Coagulation-suction tube , with Luer connector, capacity 3 mm		●	8384.71*

*HF connecting cables:

Wolf to Valleylab/ERBE	815.033
Wolf to ERBE T-series/Wolf	815.132

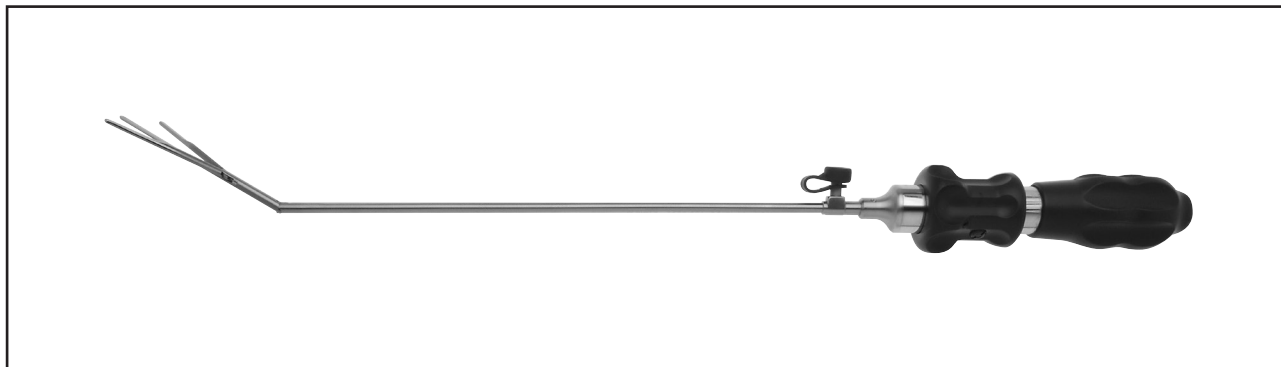
Tissue Retractor 5 mm



	WL 320 mm	Product No.
 <p>Tissue retractor, straight</p>	●	8383.691

- ❑ The extended hand of the surgeon
- ❑ Held in one hand
- ❑ Simple manipulation of tissue and organs
- ❑ Better view of concealed or difficult to access areas

Introducing Sleeve 10 mm

		Product No.
	<p>Introducing sleeve with sealing cap (89.08)</p>	<p>8389.991</p>

Knot Pusher 5 mm for endoscopic suturing



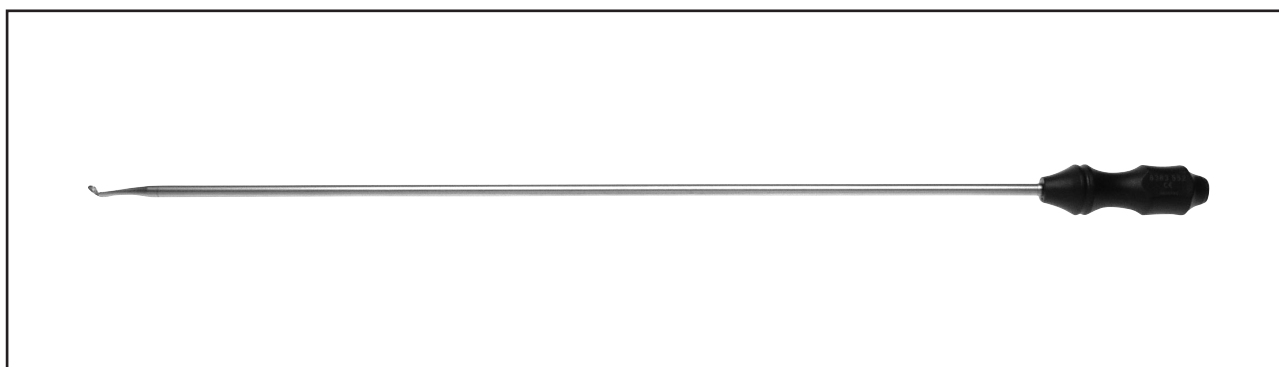

	WL 330 mm	Product No.
 Knot pusher , for intra-abdominal knots	●	8383.55

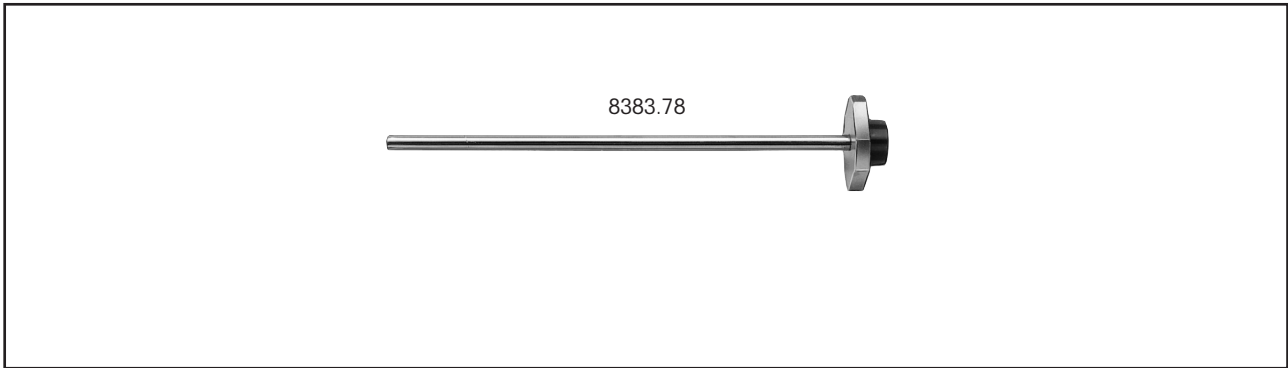

	WL 330 mm	Product No.
 Extracorporeal knot pusher by Bueß with distal notch and lateral opening for optimum knotting, extremely atraumatic tip for use as probe	●	8383.552

Applicator / Ligature Loops, 5 mm for endoscopic suturing



	WL 155 mm	Product No.
 Reducing sleeve with sealing cap*	●	8383.78

*For ligature loops or for introducing a suture with the 3 mm needle holder

Accessories:

Sealing caps, pack of 10, blue 89.02

Trocar-Site Closure Device for visualized Fascia Closure by Busche

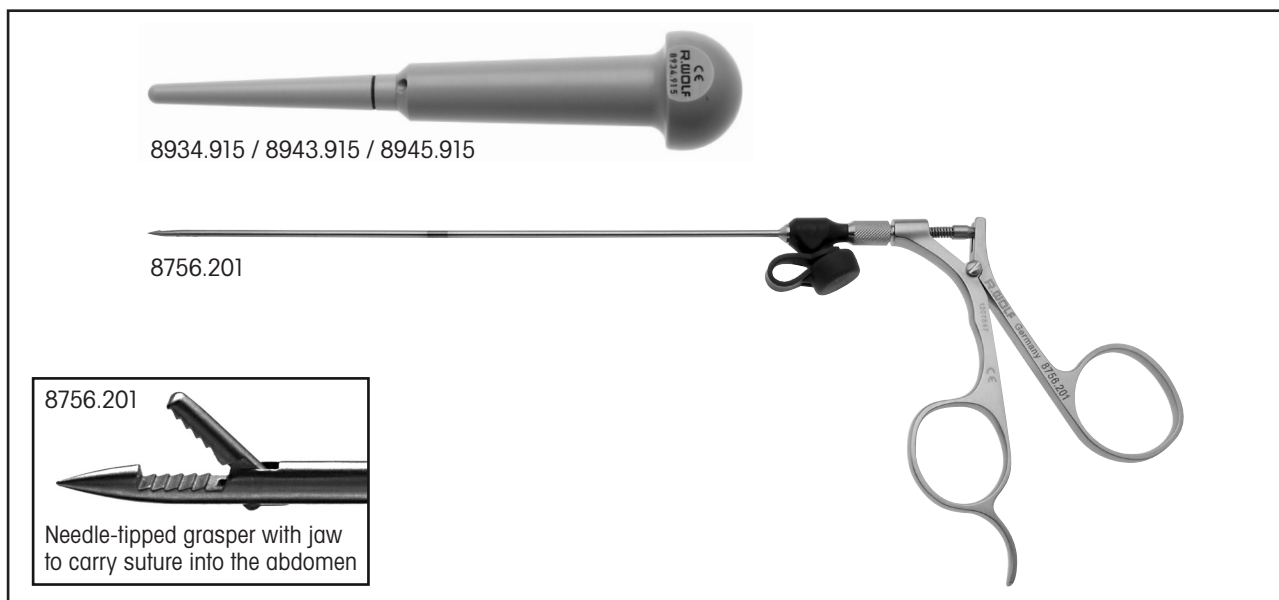

The extended tip of the device allows easy insertion of the cone which then effectively plugs the hole left when the cannula is removed. This preserves the pneumoperitoneum which can be maintained to ensure a safe distance between abdominal wall and the organs. The marking on the cone indicates the ideal position of placement for the ligature.

A suture is grasped with the special grasper and passed through the hole in the cone. This traverses the muscle, fascia and peritoneal layers. The suture is released inside the peritoneal cavity. To complete the stitch on the other side, the device is kept in place and turned through 180°. The grasper is reinserted and the intraperitoneal end of the suture is grasped and withdrawn from the peritoneal cavity as the cone is removed. The suture is tied extracorporeal under direct visual control.

Additional application is suture ligation of bleeding inferior epigastric vessels by using just the needle tipped grasper.

Closure cone

10 - 12 mm	8934.915
12 - 15 mm	8943.915
15 - 20 mm	8945.915

Needle-tipped grasper

with jaw to carry suture, Ø 2 mm, WL 160 mm, with rinsing port	8756.201
--	-----------------

Facial closure kit bundle	8756.205
--	-----------------

consisting of:

Facial closure tray (8585091M), needle forceps Ø 2.45 mm WL 160mm (8756.201),
sealing cone Ø 10-12 mm (8934.915), sealing cone Ø 12-15 mm (8943.915),
sealing cone Ø 15-20 mm (8945.915).

Injection/Aspiration
Cannulas 2 mm / 3 mm
with Luer connector

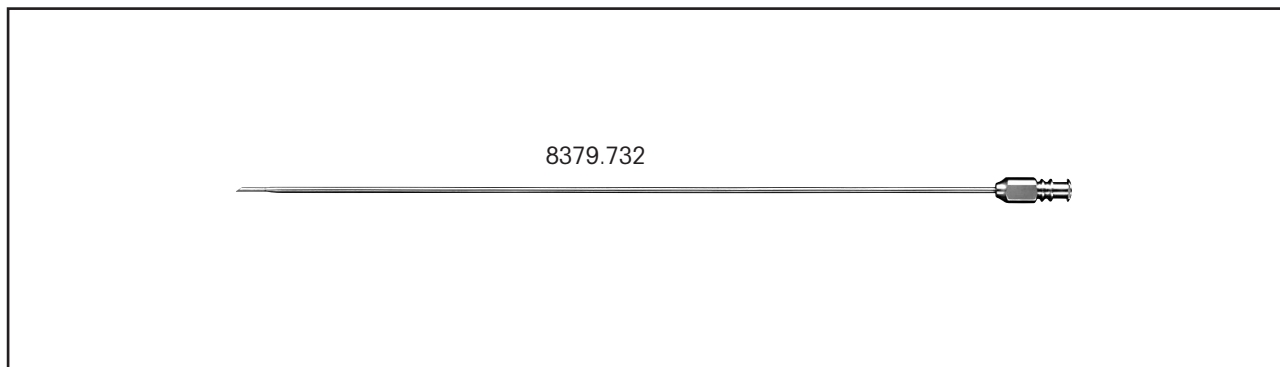

	Ø	WL 310 mm	Product No.
 Injection and aspiration cannula	3.0 mm	●	8379.732

Injection/Aspiration
Cannulas 5 mm
with Luer connector

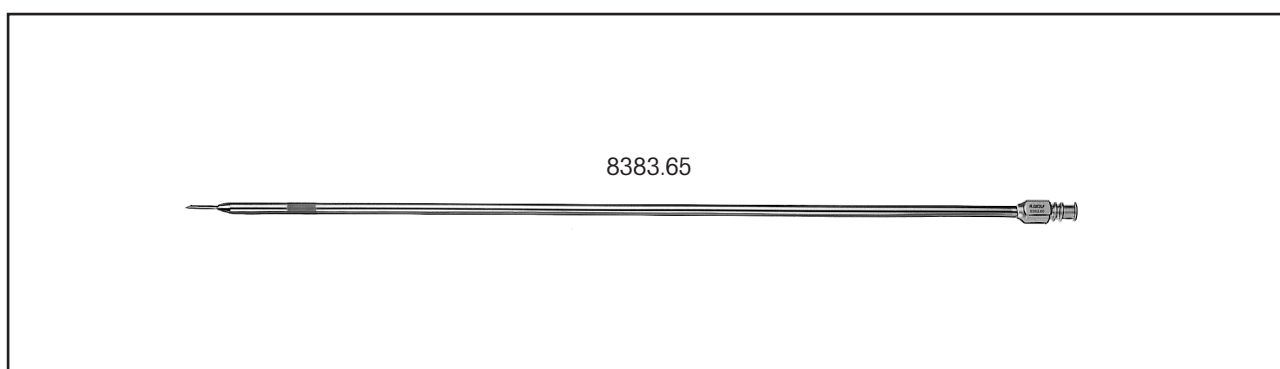

	Ø mm Tip	WL 345 mm	Product No.
 Injection cannula with 3 mm Luer connector	1.8 (15 G)	●	8383.65

LAPAROSCOPIC INSTRUMENTS

Injection/Aspiration
Coagulation 5 mm
with suction control and Luer connector

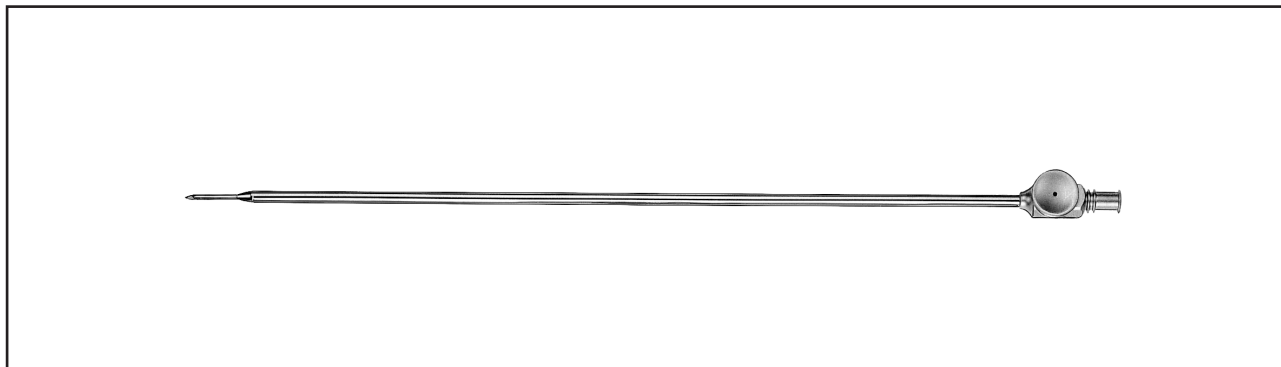

	WL 315 mm	Product No.
 Puncture cannula with suction control and 4 mm Luer connector	●	8383.49



Probe 3.5 mm

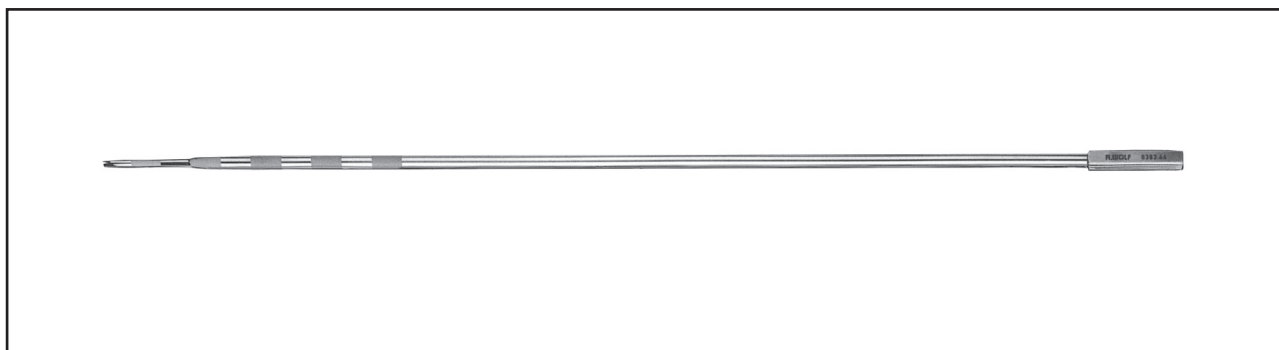

	Ø mm Tip	WL 350 mm	Product No.
 Probe, graduated	3.5 mm	●	8379.672

Probes/Manipulator 5 mm



	WL 320 mm	WL 445 mm	Product No.
	●		8383.661
Probe solid , with centimeter markings up to 5 cm		●	8384.661
		●	8384.66
Probe , graduated for palpation and measurement		●	8384.662
		●	8384.662
Probe solid* titanium (grey matte finish), with centimeter markings up to 5 cm		●	8384.662

* For use with lasers

Myoma Screw 5 mm / 10 mm

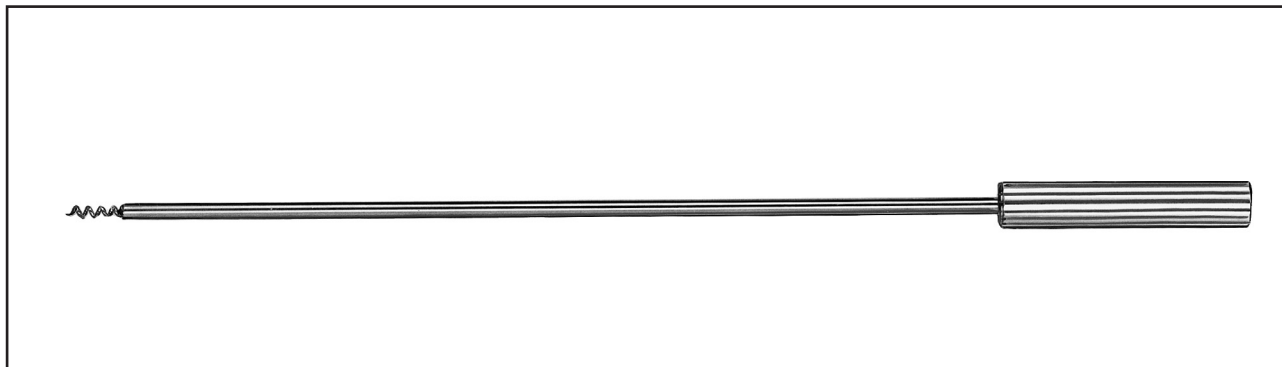

	Ø	WL 340 mm	Product No.
 Myoma screw, rigid	5 mm	●	8383.611
	10 mm	●	8385.301

Scope / Instrument Holder

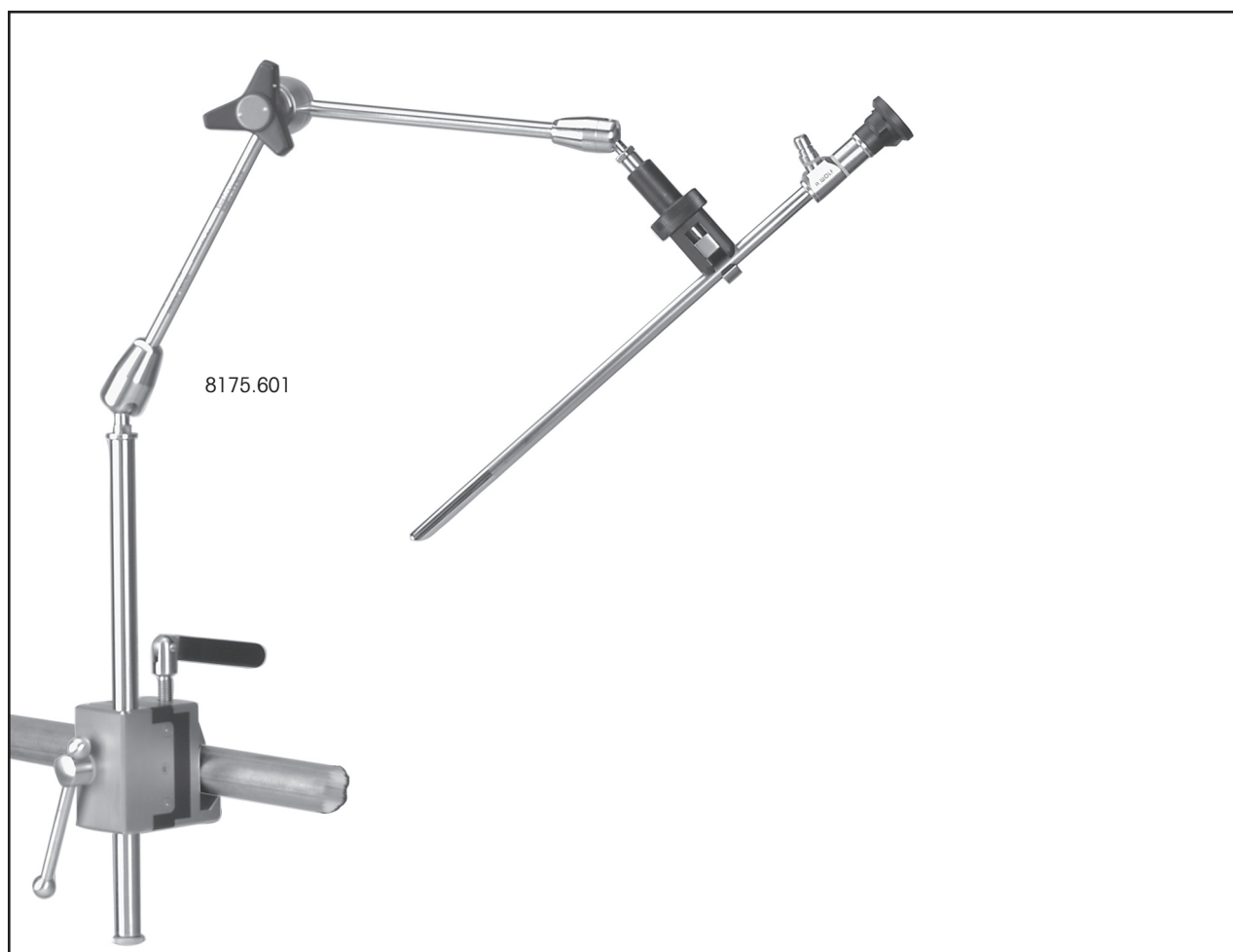









Articulating scope / instrument holder,*

stabilizes laparoscopes, trocar sleeves and liver retractors to maintain their position8175.601









*for use with instruments and scopes from 5 mm - 12 mm in diameter

HF Monopolar Connecting Cables

Connector for instrument	Connector for unit	Length	Product No.
WOLF resectoscopes 	 ERBE (T series)	3 m	815.132
		3 m	815.033
		 5 m	5 m
Monopolar HF electrodes 	Bovie / Valleylab / Erbe (Int.) / BOWA (Int.)		
WOLF resectoscopes 	 ERBE (T series)	3 m	8106.132
		3 m	8106.033
		 5 m	5 m
Monopolar HF electrodes 	Bovie / Valleylab / Erbe (Int.) / BOWA (Int.)		

ACCESSORIES

HF Bipolar Connecting Cables

Connector for instrument	Connector for unit	Length	Product No.
 <p>WOLF bipolar forceps</p>	 ERBE (ACC / ICC / T) / BOWA (EU)	3 m	8108.032
	 Martin (Int.) / 2 pin Valleylab / BOWA (Int.)	3 m	8108.033
	 WOLF / Martin (m-Version) / Berchtold / Aesculap	5 m	8108.053
		3 m	8108.031
	 EMC Dolley	5 m	8108.051
		3 m	8108035
 <p>Bipolar tweezers</p>	 Martin (Int.) / 2 pin Valleylab / BOWA (Int.)	3 m	8108.133
	 WOLF / Martin (m-Version) / Berchtold / Aesculap	3 m	8108.131
	 EMC Dolley	3 m	8108135

ACCESSORIES

TEM Combination System 2232

for transanal insufflation



Accessories:

TEM tube set, sterile, disposable	4170.801
Hygiene filter (gas), sterile, pack of 10	4171.111
Bottle adapter for TEM	8383.951
Spare O-ring, for inside of (8383.951) bottle adapter	N120030

Stereo and Documentation Telescope

for Transanal Endoscopic
Microsurgery (TEM)

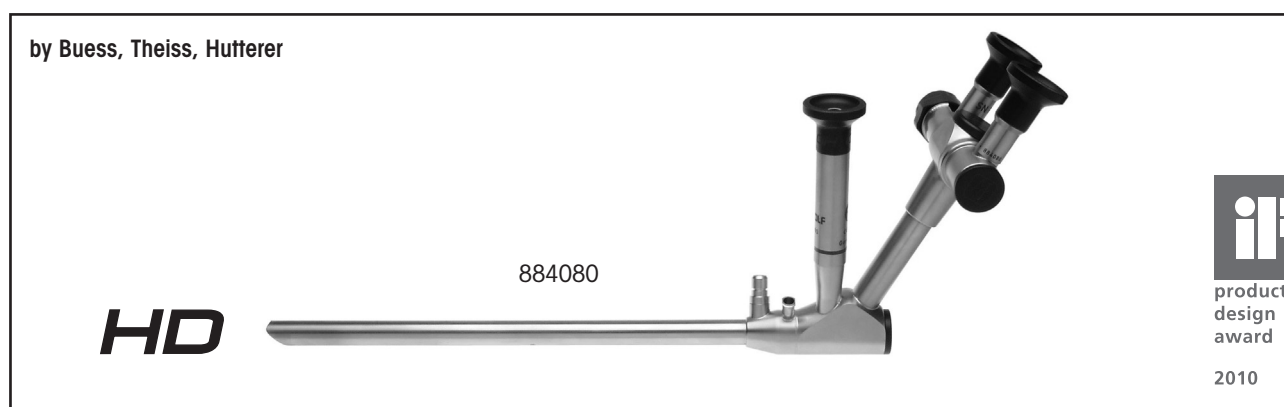

TEM Stereo and documentation telescope

with fixed eyepiece and adjustable eyepiece, Ø 13.8 mm, WL 259 mm, 50°, 70° angle of view **884080**

Recommended light cable:

Fusion fiber light cable bundle Ø 5.0 mm, 3 m long **806550301**

consisting of:

Fiber light cable (80655030), adapter projector side (8095.07) and adapter endoscope side (809509)

10 mm Telescope and Rinsing Sheath

Alternative for stereo and documentation telescope 884080

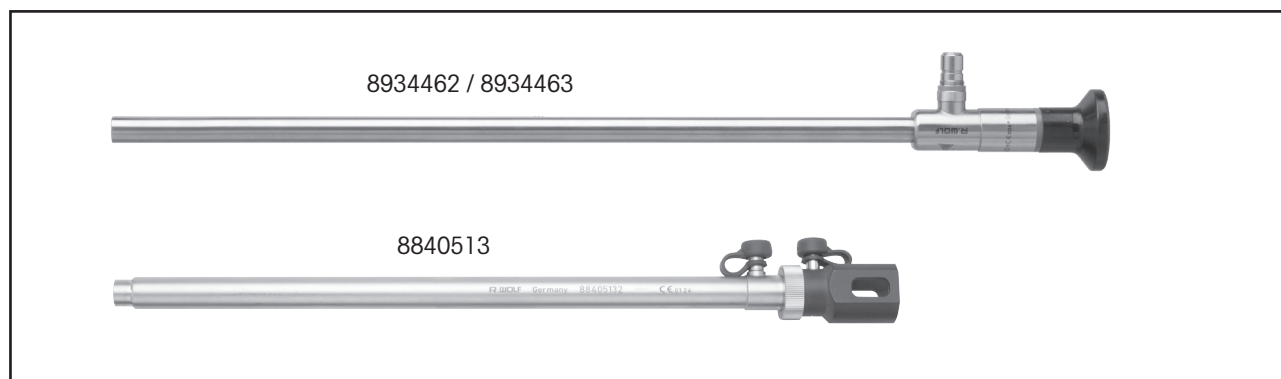

PANOVIEW ULTRA telescope, Ø 10 mm, 305 mm WL

30° **8934462**

50° **8934463**

Outer tube for rinsing and insufflation bundle **8840513**

outer Ø 13.8 mm, WL 265 mm

consisting of:

Inner tube (88405131) and outer tube (88405132)

Fusion fiber light cable bundle Ø 5.0 mm, 3 m long **806550301**

consisting of:

Fiber light cable (80655030), adapter projector side (8095.07) and adapter endoscope side (809509)

U-shaped Arm

for Transanal Endoscopic
Microsurgery (TEM)

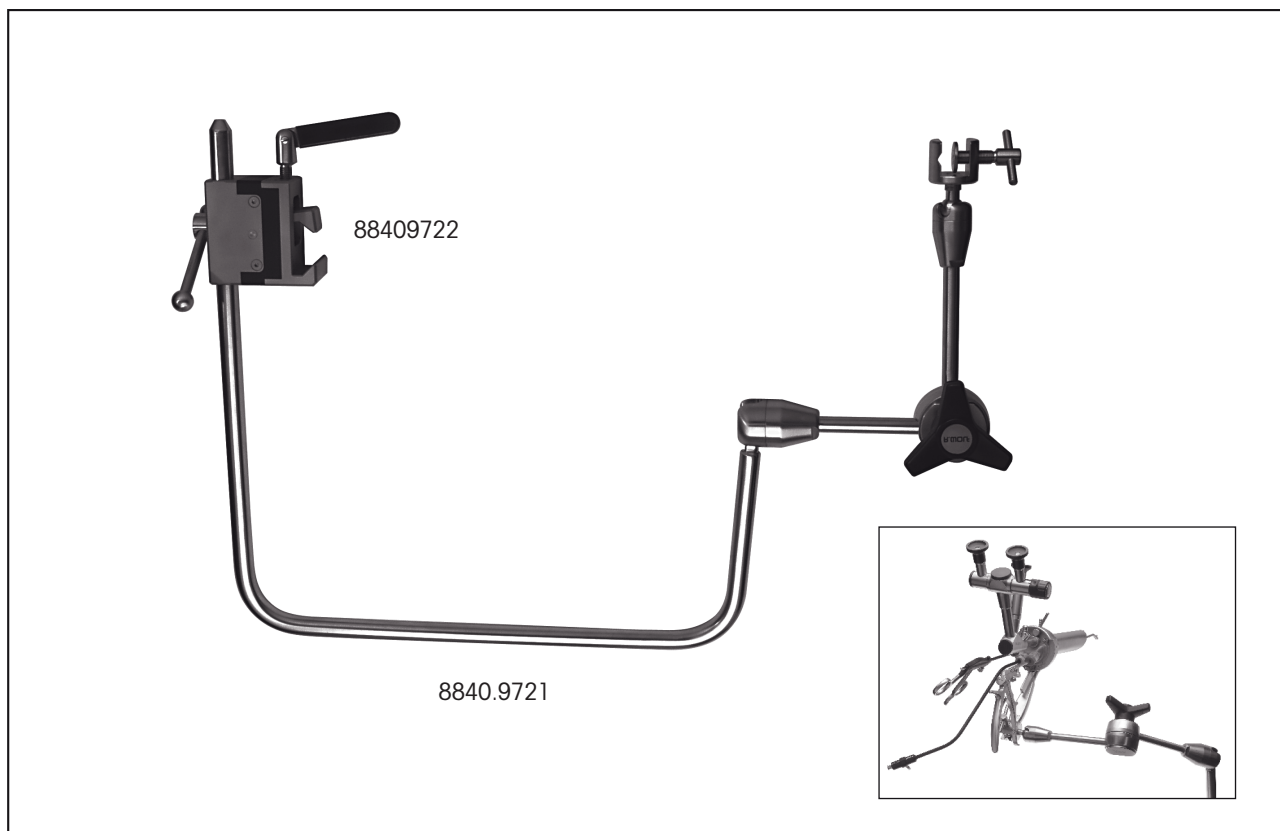

U-shaped arm

with special clamping device 8840.9721

Also required:

Clamp socket, insulated

for attachment to the operating table (standard rail) 88409722

U-shaped arm tray, metal.....8585.026

TRANSANAL
SURGERY

Rectoscope Tubes

for Transanal Endoscopic
Microsurgery (TEM)

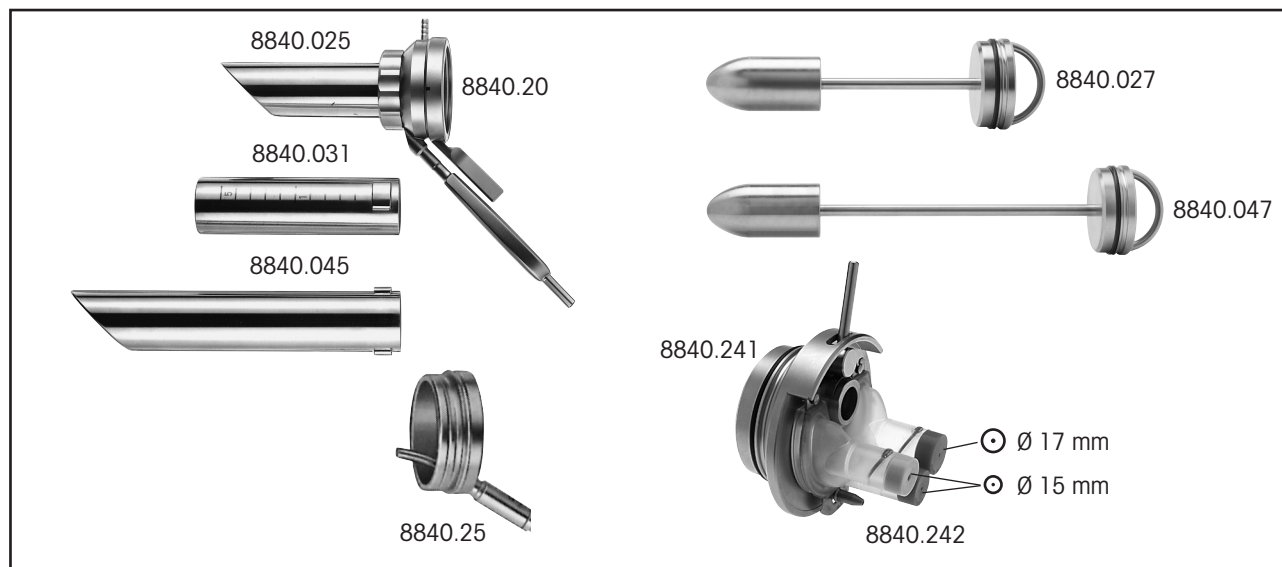



Main element	8840.20
Tube with obturator bundle , consisting of: Tube, Ø 40 mm, WL 137 mm (8840.031) and obturator (8840.027)	8840.0311
Tube with obturator bundle , consisting of: Tube, Ø 40 mm, WL 120 mm (8840.025) and obturator (8840.027)	8840.021
Tube with obturator bundle , consisting of: Tube, Ø 40 mm, WL 200 mm (8840.045) and obturator (8840.047)	8840.041
Adapter with viewing window and illumination insert	8840.25
Working insert bundle , consisting of: working insert (8840.241), sealing insert (8840.242) and sealing caps (red 89.01, blue 89.02, grey 89.03, red 89.141, blue 89.161, red 89.10)	8840.2411
Spare parts:	
Silicon sealing insert (pack of 3) with 3 valve ports (2 valve ports for up to 6 mm auxiliary instruments) (1 valve port for 6-11 mm auxiliary instruments), reusable.....	8840.242
Spare O-ring for faceplate (8840.241)	15364.067
Sealing caps (pack of 10) , outer Ø 15 mm, red, for instruments Ø 2.4 mm to Ø 3.4 mm	89.01
blue, for instruments Ø 3.4 mm to Ø 5.1 mm	89.02
grey, for instruments Ø 5.1 mm to Ø 6.0 mm	89.03
Sealing caps (pack of 10) , outer Ø 17 mm, red, for instruments Ø 4.0 mm to Ø 6.0 mm	89.141
blue, for instruments Ø 7.5 mm to Ø 8.5 mm	89.161
red, for instruments Ø 13.0 mm to Ø 13.8 mm (for back side of working insert 8840.241).....	89.10

TRANSANAL
SURGERY

Suction Tube / Knives

for transanal surgery / TEM



MONOPOLAR SUCTION TUBE					
		Ø	WL	Product No.	
		curved right	6 mm	470 mm	8840.731
Coagulation suction tube					





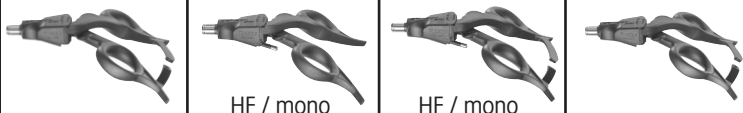

MONOPOLAR KNIFE					
		Ø	WL	Product No.	
		right	4 mm	430 mm	8840.711
		left	4 mm	430 mm	8840.712
HF knife					

TRANSANAL
SURGERY

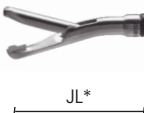
ERAGON modular

TEM Grasping Forceps, 5 mm, insulated

 <p>All jaw inserts and sheaths can also be combined with ERAGONaxial.</p>	<p>Handle type</p> 				<p>Knob attachment, ERAGONaxial</p> 
	Product No.	83930082	83930083	83930084	



<p>Jaw insert</p> 	<p>Sheath tube, insulated</p>  <p>WL 450 mm</p>	<p>Handle type</p>  <p>HF / mono with locking mechanism, rotatable</p>	<p>Complete instrument</p> <ul style="list-style-type: none"> • Jaw insert • Sheath • Handle 	
	Product No.	8394933	83930074	Bundle No.
 <p>TEM Grasping forceps, angled downwards and curved right, JL= 28 mm</p>	8394621	●	●	83946217
 <p>TEM Grasping forceps, angled downwards and curved left, JL= 28 mm</p>	8394622	●	●	83946227
 <p>TEM Grasping forceps, curved right, JL= 25 mm</p>	8394623	●	●	83946237
 <p>TEM Grasping forceps, curved left, JL= 25 mm</p>	8394624	●	●	83946247





HF connecting cable see page 87.

TRANSANAL SURGERY

ERAGON modular

Scissors, 5 mm, insulated

 <p>All jaw inserts and sheaths can also be combined with ERAGONaxial.</p>	<p>Handle type</p>  <p>HF / mono without locking mechanism, rotatable</p>	<p>Knob attachment, ERAGONaxial</p> 
	<p>Product No.</p>	83930083



<p>Jaw insert</p>  <p>JL*</p>	<p>Sheath tube, insulated</p>  <p>WL 450 mm</p>	<p>Handle type</p>  <p>HF / mono without locking mechanism, rotatable</p>	<p>Complete instrument</p> <ul style="list-style-type: none"> • Jaw insert • Sheath • Handle
<p>Product No.</p>	8394933	83930073	Bundle No.
 <p>Scissors, "Metzenbaum", curved left, double jaw action, JL= 23 mm</p>	8394.041	●	●
			83940417



* JL = Jaw length when jaws closed (approximate measurements)

HF connecting cable see page 87.

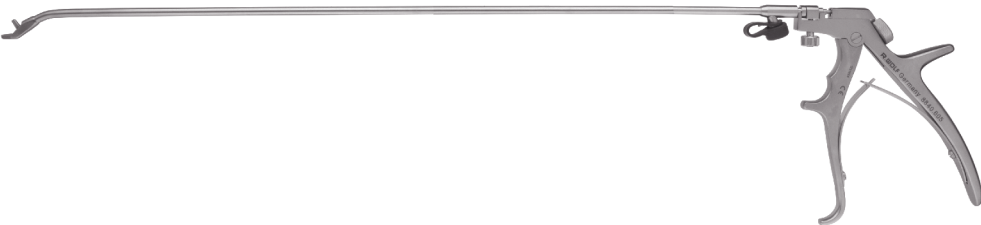
Needle Holders

for transanal surgery / TEM

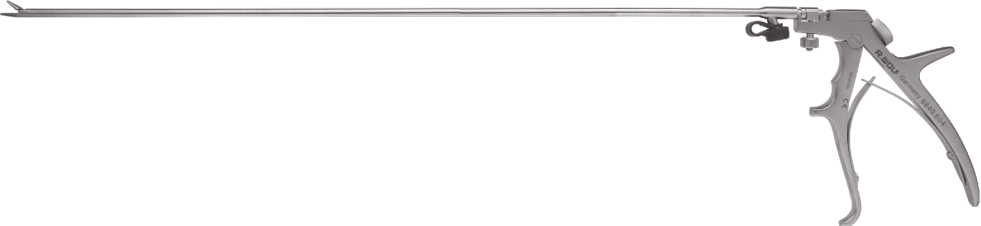
			
	Ø	WL	Product No.
 Needle holder angled downwards, with irrigation tap	4.6 mm	405 mm	8840.605

			
	Ø	WL	Product No.
 Needle holder straight, with irrigation tap	4.6 mm	405 mm	8840.604



Should be used with needles Ethicon SH-1 or Braun-Dexon, Maxon 3-0, HR 26.

TRANSANAL
SURGERY

Titanium Clips & Clip Applier

for transanal surgery / TEM

		Product No.
	Titanium clip, sterile, pack of 10 (6 clips), incl. clip mounting device	4840764

			
			
	Ø	WL	Product No.
	6 mm	435 mm	8840.762
TEM clip applicator, straight, modular, with irrigation tap			

TRANSANAL
SURGERY