

Precision with Bite

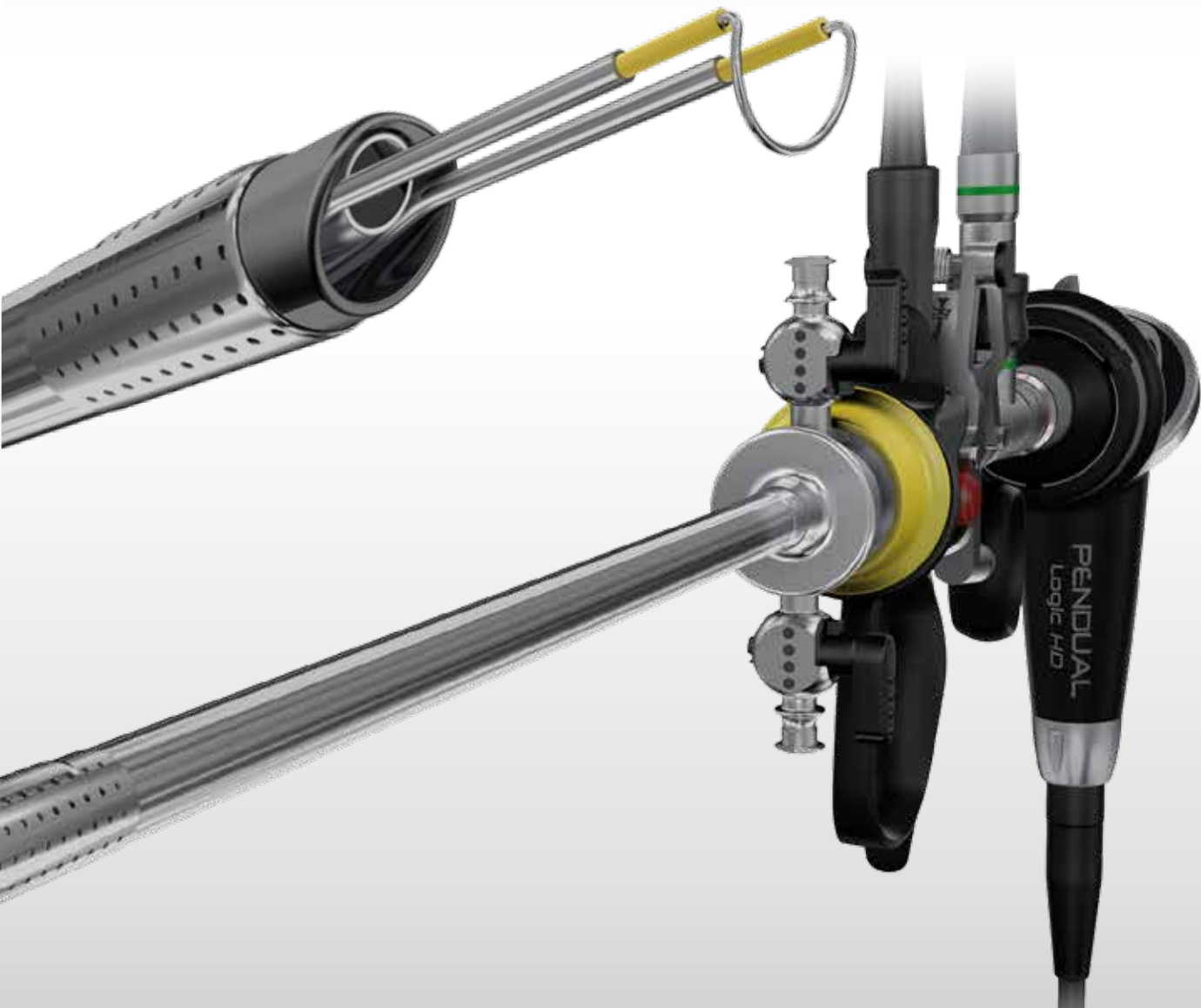

Resectoscopes from Richard Wolf

Resectoscopes — consistently efficient

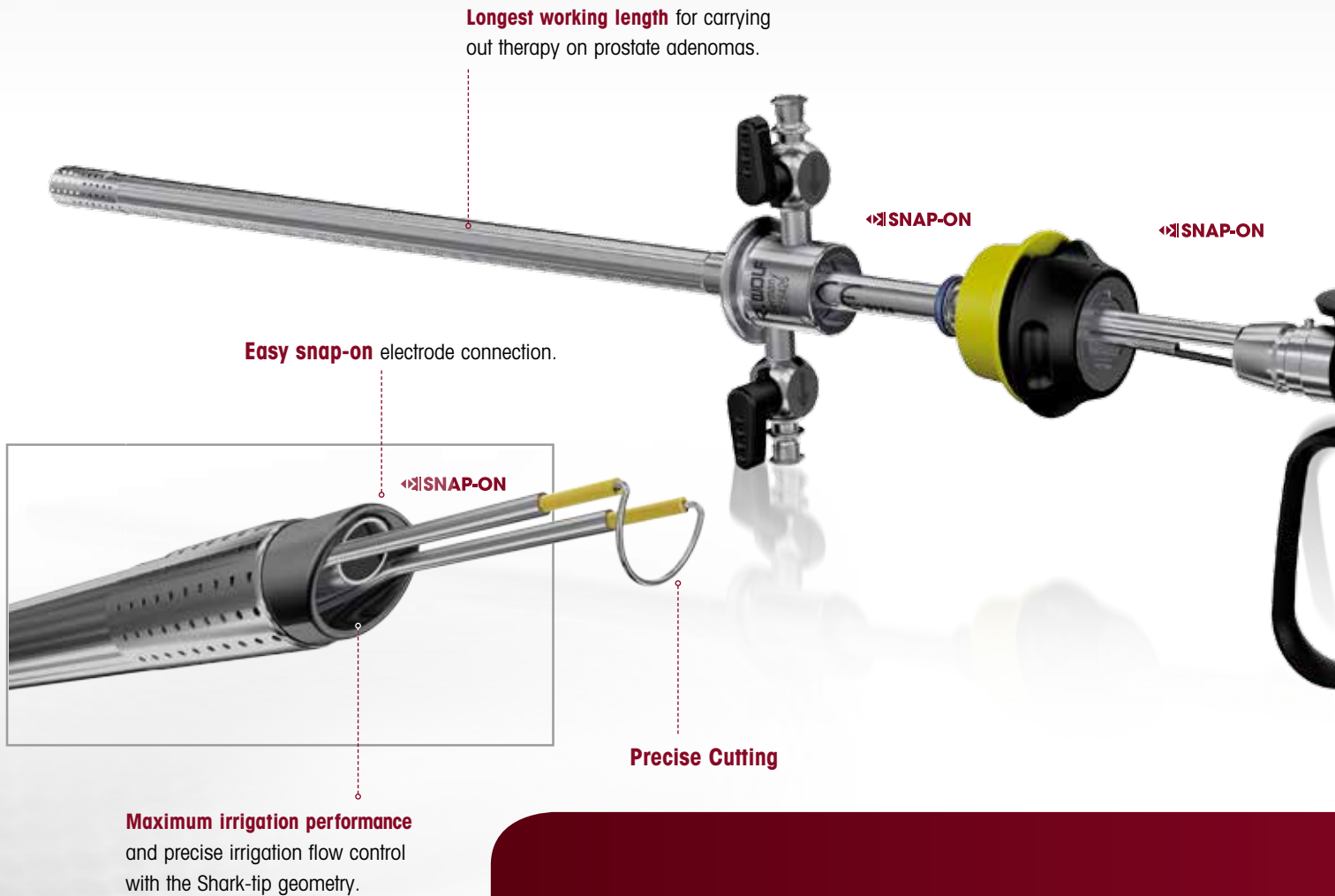

Longest working length for carrying out therapy on prostate adenomas.

Easy snap-on electrode connection.

SNAP-ON

SNAP-ON

SNAP-ON

Precise Cutting

Maximum irrigation performance and precise irrigation flow control with the Shark-tip geometry.

Progress at Every Level

The SHARK resectoscope line takes quality, comfort, control and safety to a new level. The SHARK embodies global user-experience and feedback combined with innovative technology. The result is a high-quality system with absolutely no compromises allowing surgeons to work more efficiently.



2013

Soft Stop for comfortable and fatigue-free handling during procedures.

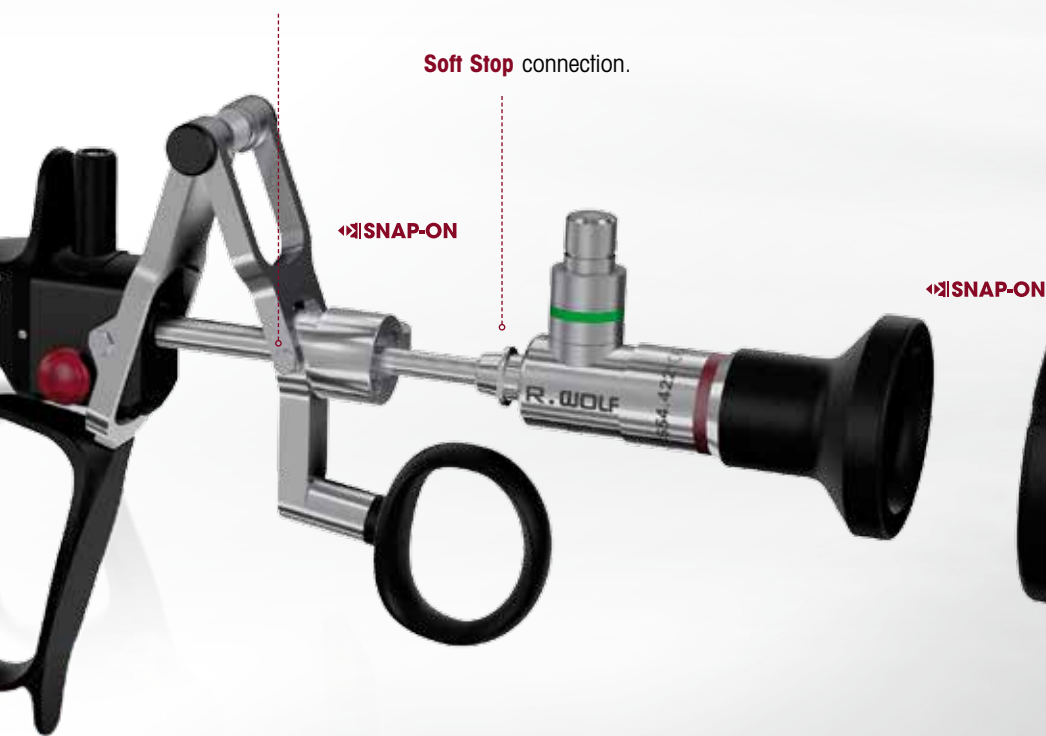

Innovative HD Pendual camera head features a simple, twist-lock action to convert the camera head for multiple endoscopic uses.

The straight handle mode is ideal for rigid/semi-rigid endoscopes. With a simple twist, the camera converts into a 90° camera, convenient for resection.



Ergonomic Overall Design For Your Work

The SHARK resectoscopes earned the coveted iF Product Design Award in 2013. Alongside design quality, the SHARK resectoscope demonstrates a high-quality finish, functionality and ergonomics.

Ergonomically designed working elements for better efficiency, comfort and control.

Quality in Your Hands

Stainless steel, ceramic and biocompatible plastics guarantee maximum service life.

Precision and ergonomic design

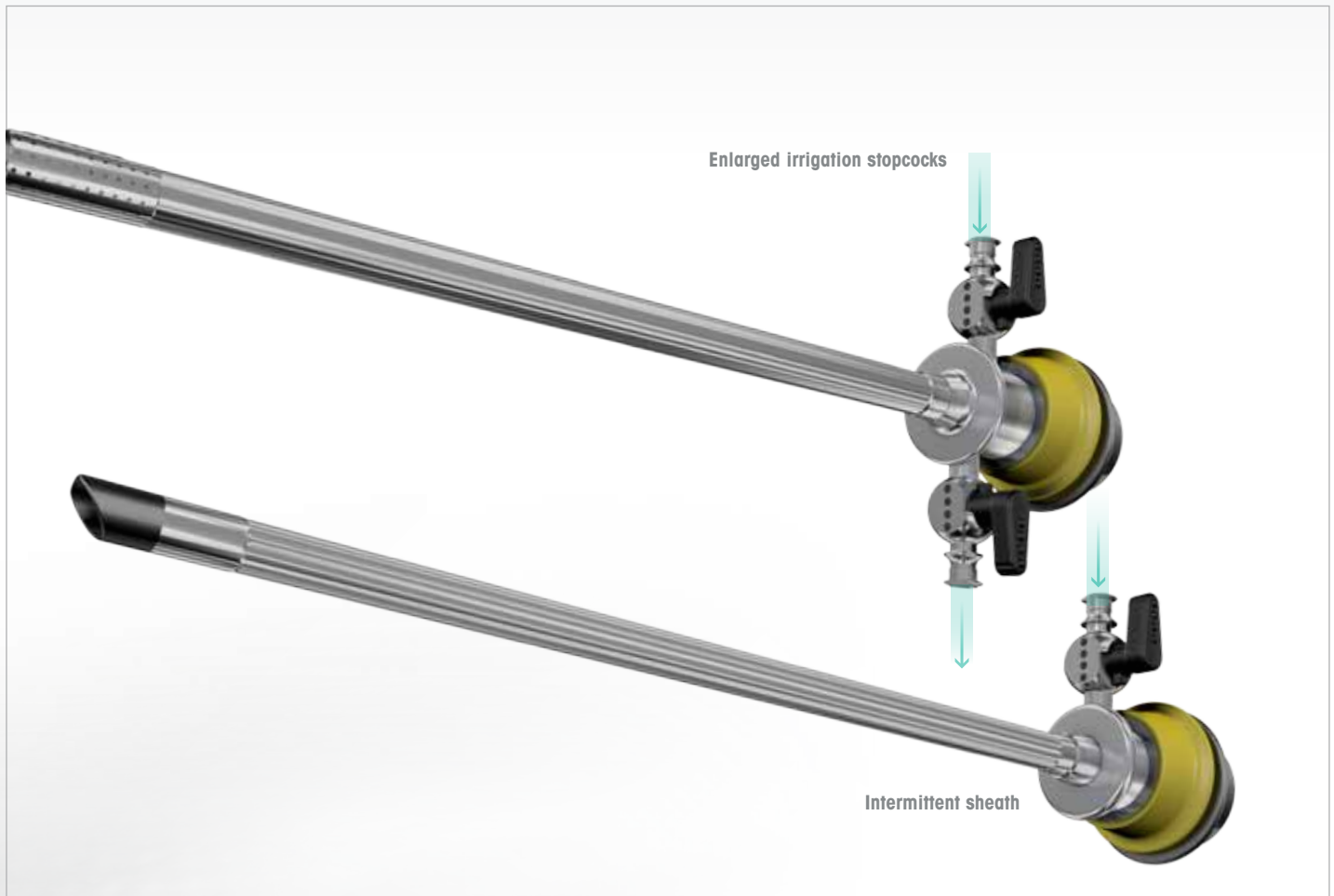

**Shark-tip sheath,
oblique sheath tip**

- **Continuous irrigation sheaths**

The pressure controlled drainage system requires no suction devices or adjustments; thus, allowing constant improved visibility.

Continuous irrigation sheath sizes in 22/24 Fr. and in 24/26 Fr. and two intermittent sheaths of 24 Fr. and 26 Fr. each.

- **Double sheath system** with 360° rotatable inner sheath.

- **Enlarged irrigation stopcocks** for improved flow characteristics.

- **Shark-tip, oblique sheath tip** at the distal end permits precise irrigation flow.

- **Compatibility** with previous models (working elements and sheaths).

- **Active or passive technology** with soft stop for a fatigue-free handling — open or closed handle design makes the instrument equally suitable for left-handed or right-handed users.
- **Ergonomic design** with special Shark-fin finger support and enlarged comfort thumb rings.
- **Soft stop mechanism** to reduce user hand fatigue.
- **Torsion-resistant system connector** for telescope, electrode and sheaths.



New details in perspective



Stability at the cutting edge—a robust electrode concept

- **Enhanced stability** on the basis of a newly designed structure for the electrode fork.
- **Precise electrode** guidance through working element and telescope.
- **Diverse selection** for every application.
- **Snap-on electrodes connection** for easy, secure intuitive electrode assembly

Color coding for sheath sizes



Coagulation electrode (roller)



Knife electrode

■ 22/24 Fr. (continuous irrigation sheath: inside 22, outside 24)

■ 24 Fr. (intermittent sheath)
■ 24/26 Fr. (continuous irrigation sheath: inside 24, outside 26)

■ 26 Fr. (intermittent sheath)











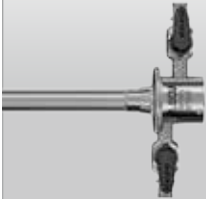

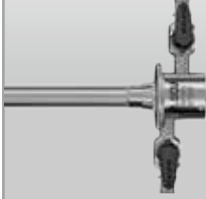
Perspectives in a changing world— innovative Pendual







- **Innovative PENDUAL pendulum camera** head for the new ENDOCAM® Logic HD platform can be easily rotated to accommodate rigid URS and PCNL.
- **Snap-on lock** for fast connection with the telescope.
- **ENDOCAM Logic HD controller** features an easy-to-operate touch screen display with intuitive and intelligent menu navigation.







Maximum diversity of sheaths, obturators, working elements and electrodes

Sheaths

Sheath size	Rotating		Non-Rotating		Rotating
	Continuous Irrigation		Continuous Irrigation		Intermittant Irrigation
	Outer sheath	Inner sheath	Outer sheath	Inner sheath	
 22/24 Fr./non-rotatable					
	8675424	8675322	86754245	86753225	–
 24/26 Fr./non-rotatable					
	8675426	8675324	86754265	86753245	8676324
 26 Fr.	–	–	–	–	8676326

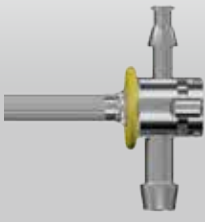
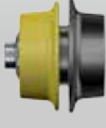
Obturator	Viewing obturator	Dilation obturator	Timberlake obturator	Direction of view	Monopolar	
					active	pas
						
8673022	8673122	–	8654.66		ergonomic handle design	ergonomic handle with comfort
8673024	8673124	8673224	8654.67	0°	8681205	–
8673026	8673126	8673226	8654.68	12°	8674205	8674225
				30°	8674205	8674225

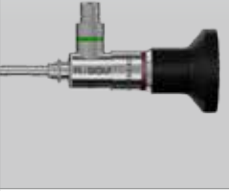

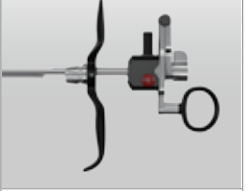
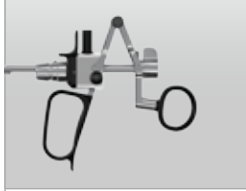
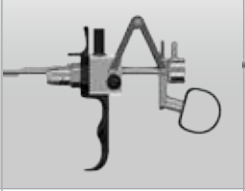
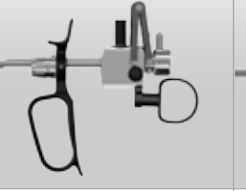
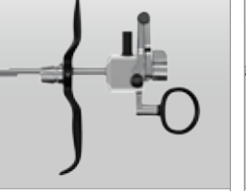



Rotatable Irrigation Adapter		Non-Rotating	
Luer connector	Luer stopcock	Intermittant Irrigation	Connecting Adapter
			
-	-	-	-
8676354	8676361	8676424	8676342
8676354	8676361	8676426	8676343

		Bipolar				Standard
active	passive	active	active	passive	passive	
ergonomic handle design with thumb rest	ergonomic handle design	ergonomic handle design	ergonomic handle design	ergonomic handle design	ergonomic handle design	
						
	8681224	8680.205	8680.204	8680.225	8680.224	8650.414
	8674224	8680.205	8680.204	8680.225	8680.224	8654.431
	8674224	8680.205	8680.204	8680.225	8680.224	8654.422

Maximum diversity of sheaths, obturators, working elements and electrodes





12°/30° disposable, monopolar

For use with monopolar cable 815.033

	Designation	Loop	For sheath sizes [in Fr.]				Color code		Catalog Number
			DS 22/24	IS 24	DS 24/26	IS 26	Fork	Stem	
	Cutting electrode	Loop ø 0.35	●	–	–	–	green	transparent	46782235
		Loop ø 0.35	–	●	●	–	yellow	transparent	46782435
		Loop ø 0.35	–	–	–	●	black	transparent	46782635
		Loop ø 0.25	●	–	–	–	yellow	transparent	46782225
		Loop ø 0.25	–	●	●	–	yellow	transparent	46782425
		Loop ø 0.8	–	●	●	–	yellow	transparent	46782480
	Coagulation electrode	Roller	●	●	●	–	green	transparent	46782201
	Coagulation electrode	Ball	●	●	●	–	green	transparent	46782202
	Coagulation electrode	Button	●	●	●	–	green	transparent	46782203
		Button	–	–	–	●	black	transparent	46782603
	Knife electrode	Knife	●	●	●	–	green	transparent	46782204
		Knife	–	–	–	●	black	transparent	46782604
	Hook electrode	Hook	●	●	●	–	green	transparent	46782205
		Hook	–	–	–	●	black	transparent	46782605



0° disposable, monopolar

For use with monopolar cable 815.033

	Designation	Loop	For sheath sizes [in Fr.]				Color code		Catalog Number
			DS 22/24	IS 24	DS 24/26	IS 26	Fork	Stem	
	Cutting electrode	Loop ø 0.35	●	–	–	–	green	transparent	46792235
			–	●	●	–	yellow	transparent	46792435
		Loop ø 0.35	–	–	–	●	black	transparent	46792635
	Coagulation electrode	Roller	–	●	●	●	green	transparent	46792201
	Knife electrode	Knife	–	●	●	●	transparent	transparent	46792204
	Hook electrode	Hook	–	●	●	●	transparent	transparent	46792205

12°/30° disposable, bipolar





For use with bipolar cable 8108.232

	Designation	Loop	For sheath sizes [in Fr.]				Color code		Catalog Number
			DS 22/24	IS 24	DS 24/26	IS 26	Fork	Stem	
	Cutting electrode, round	Loop ø 2.5	●	–	–	–	blue	blue	4622.2533
		Loop ø 2.5	–	●	●	●	blue	blue	4622.2513
		Loop ø 0.3	●	–	–	–	green	blue	4622.1333
		Loop ø 0.3	–	●	●	–	green	blue	4622.1313 4624.1313
	Cutting electrode, oval	Loop ø 0.3	●	●	●	–	blue	blue	4609.0323
	BiVAP, Bipolar Vaporization electrode	Button	●	●	–	–	blue	yellow	4630.0223
			–	–	–	●			46300243
	Hook electrode	Hook	●	●	●	–	blue	yellow	862309*
	Coagulating electrode	Ball	●	–	–	–	blue	blue	4623.0243
			●	–	●	–			4623.0233

*NOT STERILE

0°, for single use, sterile, bipolar

For use with bipolar cable 8108.232

	Designation	Loop	For sheath sizes [in Fr.]				Color code		Catalog Number
			DS 22/24	IS 24	DS 24/26	IS 26	Fork	Stem	
	Cutting electrode (pack of 3)	Loop ø 0.3 mm	–	●	●	–	blue	blue	4609.0313
		–	–	●	–	–	green	blue	4611.0313
		Loop ø 0.25 mm	–	–	–	●	blue	blue	4609.2513
	Cutting electrode, oval (pack of 3)	Loop ø 0.3 mm	–	●	●	●	blue	blue	4609.0323
	Coagulation electrode (pack of 3)	Cylinder ø 1.2 mm	●	●	●	●	blue	blue	4610.0223
	BiVAP electrode (pack of 3)	Donut	–	●	●	●	blue	blue	46310243

● available for the relevant sheath size – not available * packed single, sterile

DS = Continuous irrigation **IS** = intermittent irrigation

